



# SINGLE-SUPPLY, RAIL-TO-RAIL OPERATIONAL AMPLIFIER WITH SHUTDOWN

## *microAmplifier™* Series

### FEATURES

- RAIL-TO-RAIL INPUT AND OUTPUT SWING
- *MicroSIZE* PACKAGES
- BANDWIDTH: 5.5MHz
- SLEW RATE: 6V/μs
- QUIESCENT CURRENT: 750μA/Chan
- POWER SHUTDOWN MODE

### APPLICATIONS

- SENSOR BIASING
- SIGNAL CONDITIONING
- DATA ACQUISITION
- PROCESS CONTROL
- ACTIVE FILTERS
- TEST EQUIPMENT

### DESCRIPTION

The OPA341 series rail-to-rail CMOS operational amplifiers are designed for low-cost, miniature applications. They are optimized for low-voltage, single-supply operation. Rail-to-rail input and output and high-speed operation make them ideal for driving sampling Analog-to-Digital (A/D) converters.

The power-saving shutdown feature makes the OPA341 ideal for portable low-power applications. The OPA341 series is also well suited for general-purpose and audio applications as well as providing I/V conversion at the output of Digital-to-Analog (D/A) converters. Single and dual versions have identical specifications for design flexibility.

The OPA341 series operate on a single supply as low as 2.5V, and input common-mode voltage range extends 300mV beyond the supply rails. Output voltage swings to within 1mV of the supply rails with a 100kΩ load. The OPA341 series offers excellent dynamic response (BW = 5.5MHz, SR = 6V/μs) with a quiescent current of only 750μA. The dual design features completely independent circuitry for lowest crosstalk and freedom from interaction.

The single (OPA341) packages are the tiny SOT23-6 surface mount and SO-8 surface mount. The dual (OPA2341) comes in the miniature MSOP-10 surface mount. All are specified from -55°C to +125°C and operate from -55°C to +150°C. The OPA343 provides similar performance without shutdown capability.

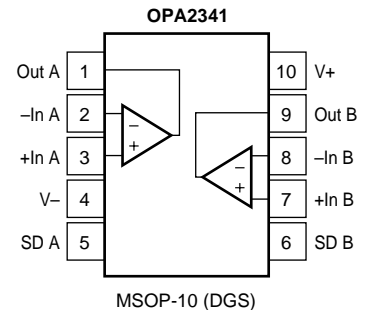
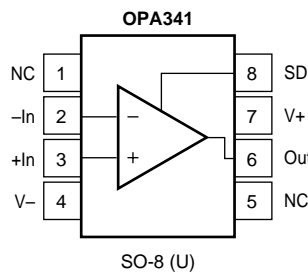
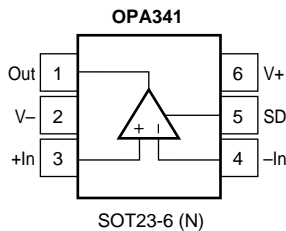

Please be aware that an important notice concerning availability, standard warranty, and use in critical applications of Texas Instruments semiconductor products and disclaimers thereto appears at the end of this data sheet.

## ABSOLUTE MAXIMUM RATINGS<sup>(1)</sup>

Supply Voltage, V+ to V- .....	6.0V
Input Voltage Range <sup>(2)</sup> .....	(V-) - 0.5V to (V+) + 0.5V
Input Terminal <sup>(3)</sup> .....	10mA
Output Short Circuit <sup>(3)</sup> .....	Continuous
Operating Temperature .....	-55°C to +150°C
Storage Temperature .....	-65°C to +150°C
Junction Temperature .....	150°C
Lead Temperature (soldering, 10s) .....	300°C

NOTES: (1) Stresses above these ratings may cause permanent damage. Exposure to absolute maximum conditions for extended periods may degrade device reliability. (2) Input terminals are diode-clamped to the power supply rails. Input signals that can swing more than 0.5V beyond the supply rails should be current-limited to 10mA or less. (3) Short-circuit to ground, one amplifier per package.



## ELECTROSTATIC DISCHARGE SENSITIVITY

This integrated circuit can be damaged by ESD. Texas Instruments recommends that all integrated circuits be handled with appropriate precautions. Failure to observe proper handling and installation procedures can cause damage.

ESD damage can range from subtle performance degradation to complete device failure. Precision integrated circuits may be more susceptible to damage because very small parametric changes could cause the device not to meet its published specifications.

## PACKAGE/ORDERING INFORMATION

PRODUCT	PACKAGE	PACKAGE DRAWING NUMBER	PACKAGE DESIGNATOR	SPECIFIED TEMPERATURE RANGE	PACKAGE MARKING	ORDERING NUMBER <sup>(1)</sup>	TRANSPORT MEDIA
OPA341NA	SOT23-6	332	—	-55°C to +125°C	B41	OPA341NA/250	Tape and Reel
"	"	"	—	"	"	OPA341NA/3K	Tape and Reel
OPA341UA	SO-8	182	—	-55°C to +125°C	OPA341UA	OPA341UA	Rails
"	"	"	—	"	"	OPA341UA/2K5	Tape and Reel
OPA2341DGSA	MSOP-10	4073272	DGS	-55°C to +125°C	C41	OPA2341DGSA/250	Tape and Reel
"	"	"	"	"	"	OPA2341DGSA/2K5	Tape and Reel

NOTE: (1) Models with a slash (/) are available only in Tape and Reel in the quantities indicated (e.g., /3K indicates 3000 devices per reel). Ordering 3000 pieces of "OPA341NA/3K" will get a single 3000-piece Tape and Reel.

# ELECTRICAL CHARACTERISTICS: $V_S = 2.7V$ to $5.5V$

**Boldface** limits apply over the specified temperature range,  $T_A = -55^\circ C$  to  $+125^\circ C$ .

At  $T_A = +25^\circ C$ ,  $R_L = 10k\Omega$  connected to  $V_S/2$  and  $V_{OUT} = V_S/2$ ,  $V_{ENABLE} = V_{DD}$ , unless otherwise noted.

PARAMETER	CONDITION	OPA341NA, UA OPA2341DGSA			UNITS
		MIN	TYP	MAX	
<b>OFFSET VOLTAGE</b> Input Offset Voltage <b>Drift</b> vs Power Supply <b>Over Temperature</b> Channel Separation, dc	$V_{OS}$ $dV_{OS}/dT$ PSRR $V_S = 5V$ $V_S = 2.7V$ to $5.5V$ , $V_{CM} = 0V$ <b><math>V_S = 2.7V</math> to <math>5.5V</math>, <math>V_{CM} = 0V</math></b>		$\pm 2$ $\pm 2$ 40 0.2	$\pm 6$  200 <b>200</b>	mV $\mu V/^\circ C$ $\mu V/V$ $\mu V/V$
<b>INPUT BIAS CURRENT</b> Input Bias Current <b>Over Temperature</b> Input Offset Current	$I_B$ $I_{OS}$		$\pm 0.6$ $\pm 0.2$	$\pm 10$ <b>2000</b> $\pm 10$	pA <b>pA</b> pA
<b>NOISE</b> Input Voltage Noise, $f = 0.1Hz$ to $50kHz$ Input Voltage Noise Density, $f = 1kHz$ Input Current Noise Density, $f = 1kHz$	$e_n$ $i_n$		8 25 3		$\mu V_{rms}$ $nV/\sqrt{Hz}$ $fA/\sqrt{Hz}$
<b>INPUT VOLTAGE RANGE</b> <b>Common-Mode Voltage Range</b> Common-Mode Rejection Ratio <b>Over Temperature</b> <b>Over Temperature</b> <b>Over Temperature</b>	$V_{CM}$ CMRR $V_S = 5V$ , $(V-) - 0.3V < V_{CM} < (V+) - 1.8V$ <b><math>V_S = 5V</math>, <math>(V-) - 0.1V &lt; V_{CM} &lt; (V+) - 1.8V</math></b> $V_S = 5V$ , $(V-) - 0.3V < V_{CM} < (V+) + 0.3V$ <b><math>V_S = 5V</math>, <math>(V-) - 0.1V &lt; V_{CM} &lt; (V+) + 0.1V</math></b> $V_S = 2.7V$ , $(V-) - 0.3V < V_{CM} < (V+) + 0.3V$ <b><math>V_S = 2.7V</math>, <math>(V-) - 0.1V &lt; V_{CM} &lt; (V+) + 0.1V</math></b>	$(V-) - 0.3$ <b><math>(V-) - 0.1</math></b> 76 <b>74</b> 60 <b>58</b> 57 <b>55</b>	90 74 70	$(V+) + 0.3$ <b><math>(V+) + 0.1</math></b>	V <b>V</b> dB <b>dB</b> dB <b>dB</b> dB <b>dB</b>
<b>INPUT IMPEDANCE</b> Differential Common-Mode			$10^{13} \parallel 3$ $10^{13} \parallel 6$		$\Omega \parallel pF$ $\Omega \parallel pF$
<b>OPEN-LOOP GAIN</b> Open-Loop Voltage Gain <b>Over Temperature</b> <b>Over Temperature</b>	$A_{OL}$ $R_L = 100k\Omega$ , $(V-) + 5mV < V_O < (V+) - 5mV$ <b><math>R_L = 100k\Omega</math>, <math>(V-) + 5mV &lt; V_O &lt; (V+) - 5mV</math></b> $R_L = 2k\Omega$ , $(V-) + 200mV < V_O < (V+) - 200mV$ <b><math>R_L = 2k\Omega</math>, <math>(V-) + 200mV &lt; V_O &lt; (V+) - 200mV</math></b>	100 <b>100</b> 96 <b>94</b>	120 110		dB <b>dB</b> dB <b>dB</b>
<b>FREQUENCY RESPONSE</b> Gain-Bandwidth Product Slew Rate Settling Time, 0.1% 0.01% Overload Recovery Time Total Harmonic Distortion + Noise	GBW SR $t_S$ $t_{SR}$ THD+N $V_S = 5V$ $G = +1$ , $C_L = 100pF$ $V_S = 5V$ , 2V Step, $G = +1$ , $C_L = 100pF$ $V_S = 5V$ , 2V Step, $G = +1$ , $C_L = 100pF$ $V_{IN} \cdot \text{Gain} \leq V_S$ $V_S = 5V$ , $V_O = 3V_p$ (1), $G = +1$ , $f = 1kHz$		5.5 6 1 1.6 0.2 0.0007		MHz V/ $\mu s$ $\mu s$ $\mu s$ $\mu s$ %
<b>OUTPUT</b> Voltage Output Swing from Rail <b>Over Temperature</b> <b>Over Temperature</b> Short-Circuit Current Capacitive Load Drive	$I_{SC}$ $C_{LOAD}$ $R_L = 100k\Omega$ , $A_{OL} > 100dB$ <b><math>R_L = 100k\Omega</math>, <math>A_{OL} &gt; 100dB</math></b> $R_L = 2k\Omega$ , $A_{OL} > 96dB$ <b><math>R_L = 2k\Omega</math>, <math>A_{OL} &gt; 94dB</math></b>		1 40 $\pm 50$	5 <b>5</b> 200 <b>200</b>	mV <b>mV</b> mV <b>mV</b> mA
<b>SHUTDOWN</b> $t_{OFF}$ $t_{ON}$ $V_L$ (Shutdown) $V_H$ (Amplifier is Active) $I_{QSD}$			1 3 10	$(V-) + 0.8$ $V+$	$\mu s$ $\mu s$ V V nA
<b>POWER SUPPLY</b> Specified Voltage Range Operating Voltage Range Quiescent Current (per amplifier) <b>Over Temperature</b>	$V_S$ $I_Q$ $I_O = 0$ , $V_S = 5V$	2.7	2.5 to 5.5 0.75	5.5 1.0 <b>1.2</b>	V V mA <b>mA</b>
<b>TEMPERATURE RANGE</b> Specified Range Operating Range Storage Range Thermal Resistance SOT-23-6 Surface Mount MSOP-10 Surface Mount SO-8 Surface Mount	$\theta_{JA}$	-55 -55 -65		125 150 150	$^\circ C$ $^\circ C$ $^\circ C$ $^\circ C/W$ $^\circ C/W$ $^\circ C/W$ $^\circ C/W$

NOTE: (1)  $V_{OUT} = 0.25V$  to  $3.25V$ .

# TYPICAL CHARACTERISTICS

At  $T_A = +25^\circ\text{C}$ ,  $V_{\text{ENABLE}} = V_{\text{DD}}$ ,  $V_S = +5\text{V}$ ,  $R_L = 10\text{k}\Omega$ , unless otherwise noted.

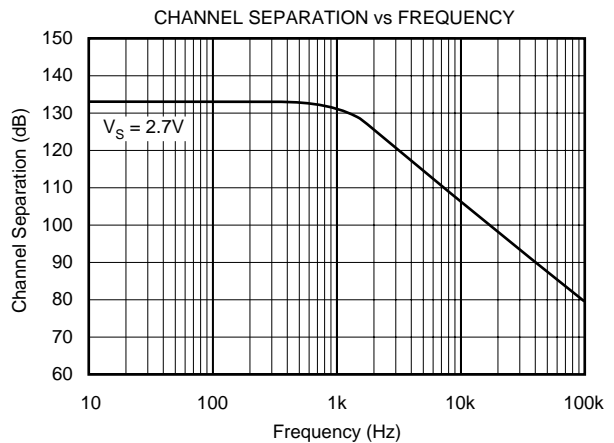
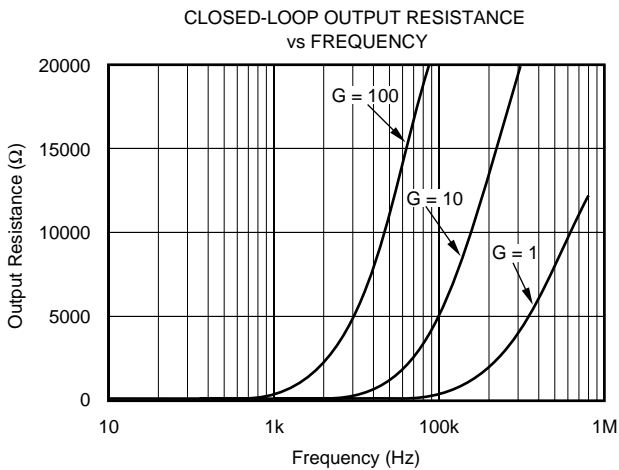
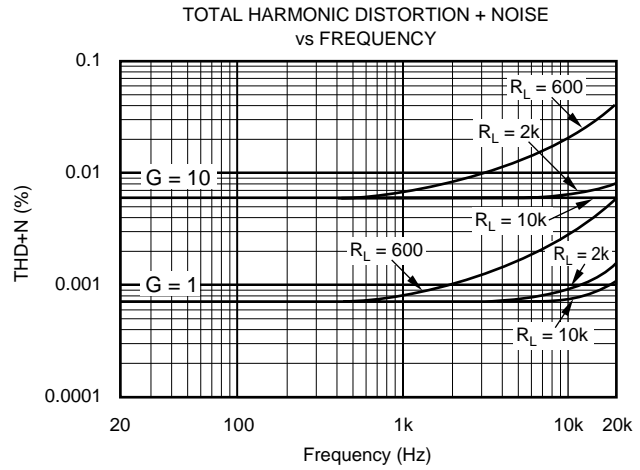
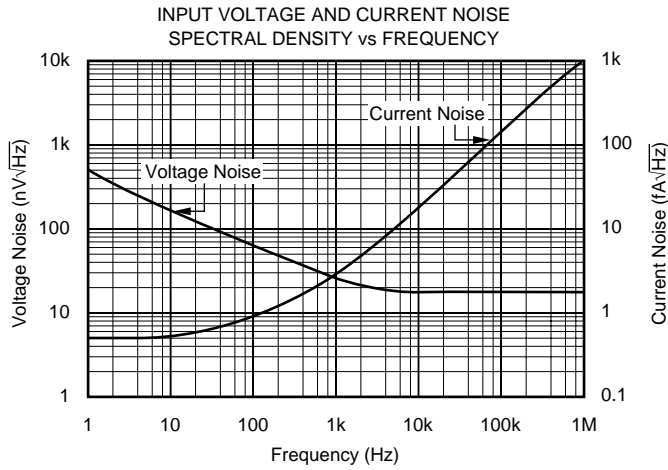
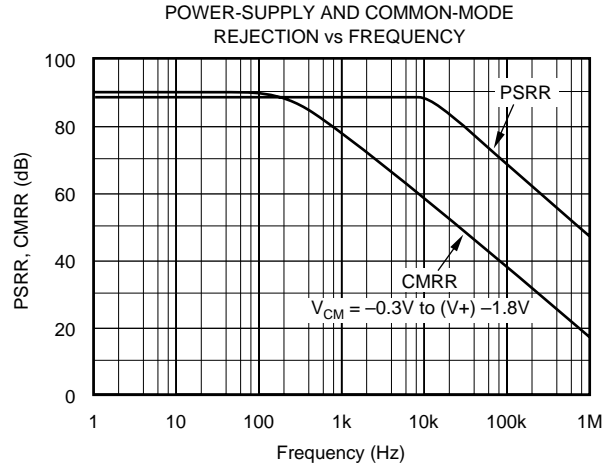
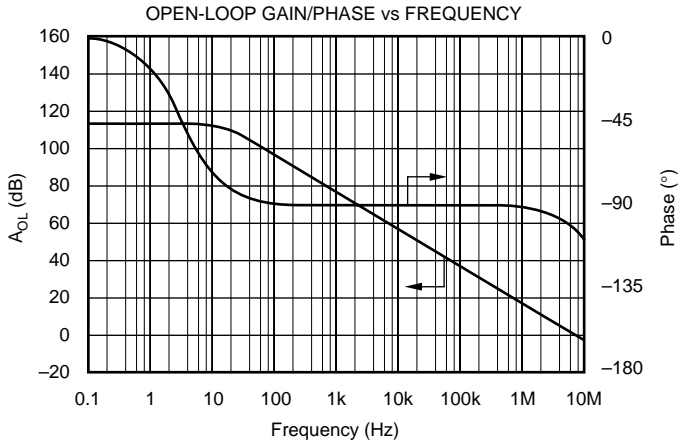

# TYPICAL CHARACTERISTICS (Cont.)

At  $T_A = +25^\circ\text{C}$ ,  $V_{\text{ENABLE}} = V_{\text{DD}}$ ,  $V_S = +5\text{V}$ ,  $R_L = 10\text{k}\Omega$ , unless otherwise noted.

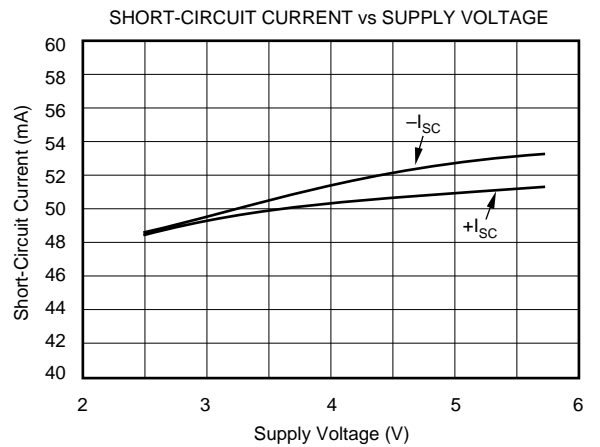
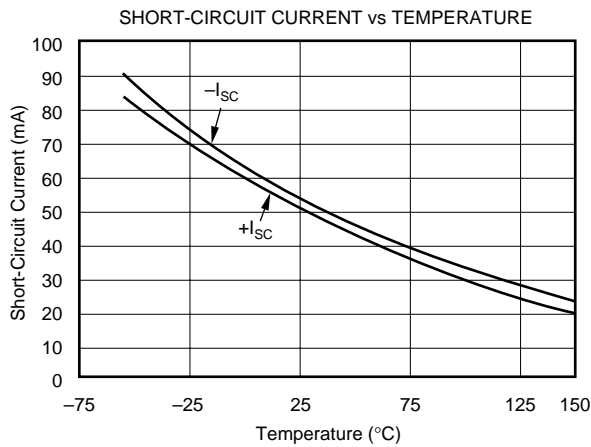
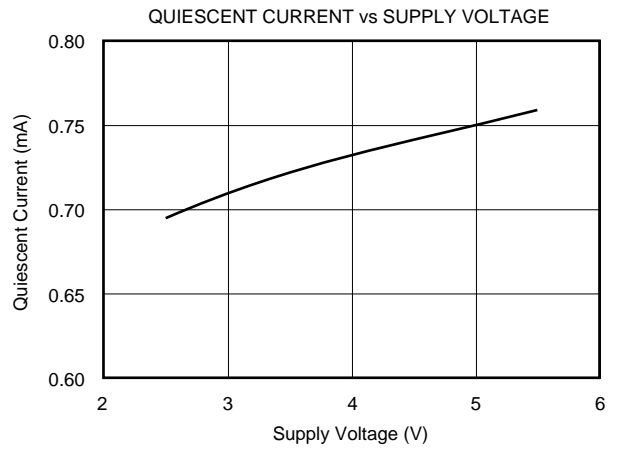
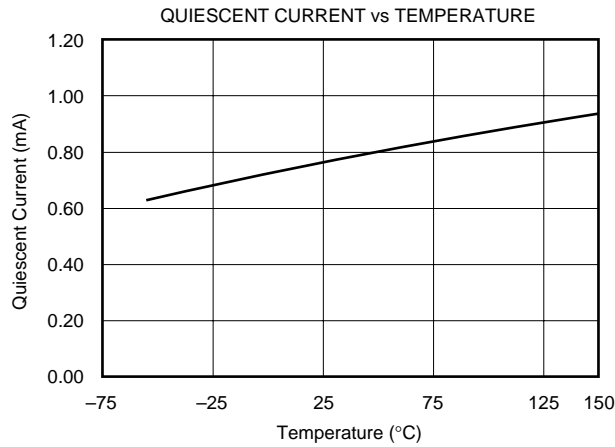
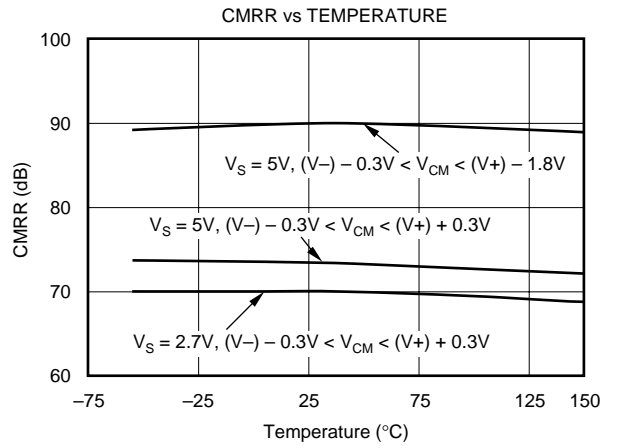
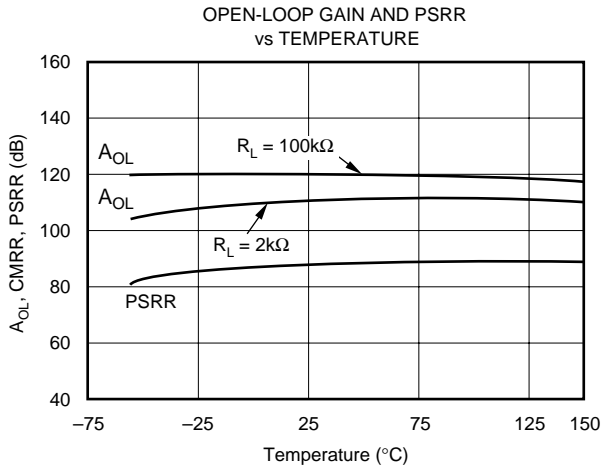

# TYPICAL CHARACTERISTICS (Cont.)

At  $T_A = +25^\circ\text{C}$ ,  $V_{\text{ENABLE}} = V_{\text{DD}}$ ,  $V_S = +5\text{V}$ ,  $R_L = 10\text{k}\Omega$ , unless otherwise noted.

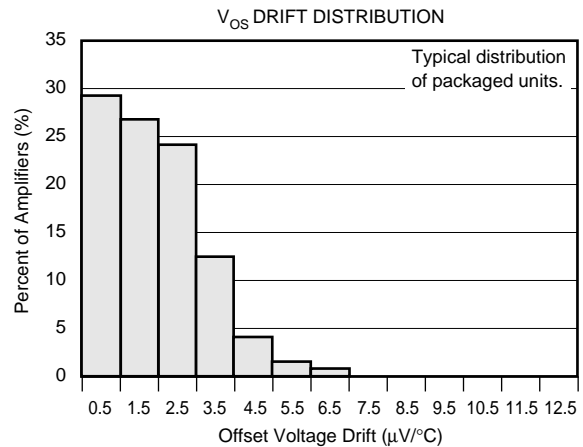
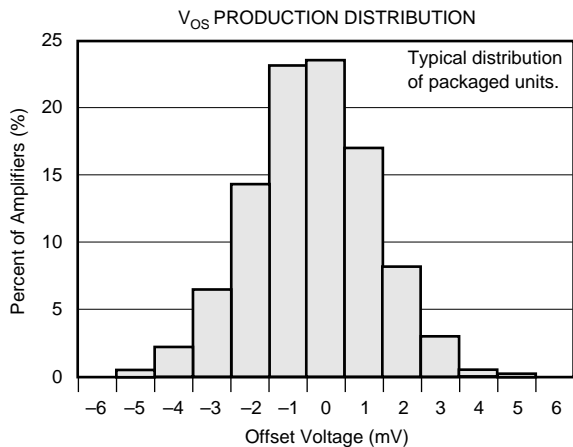
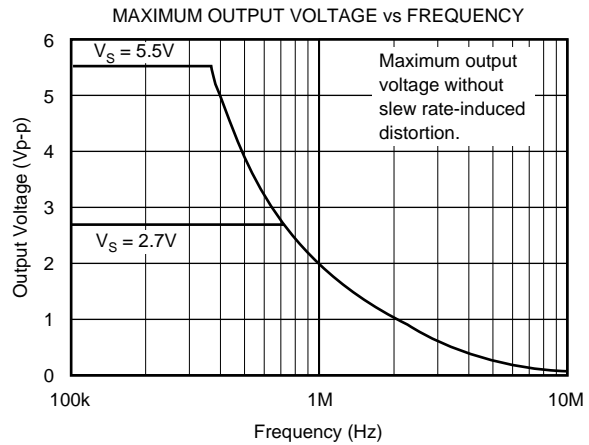
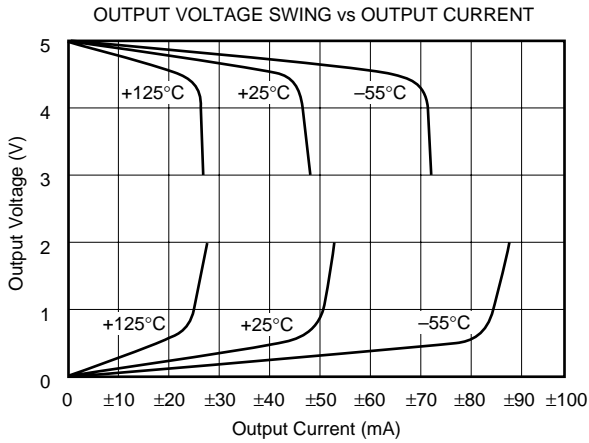
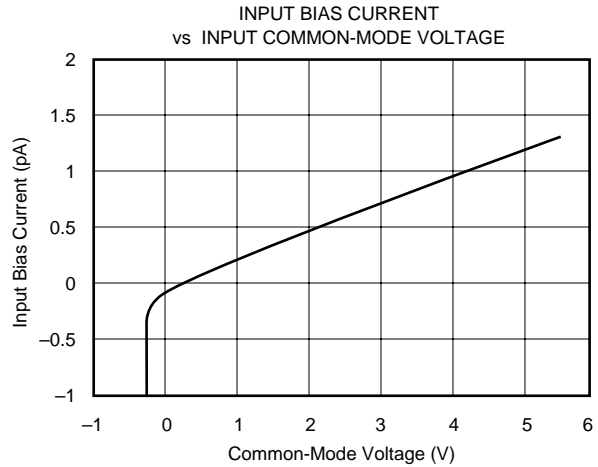
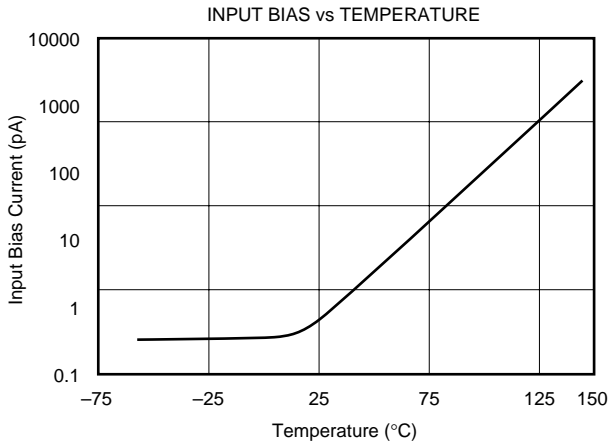

# TYPICAL CHARACTERISTICS (Cont.)

At  $T_A = +25^\circ\text{C}$ ,  $V_{\text{ENABLE}} = V_{\text{DD}}$ ,  $V_S = +5\text{V}$ ,  $R_L = 10\text{k}\Omega$ , unless otherwise noted.

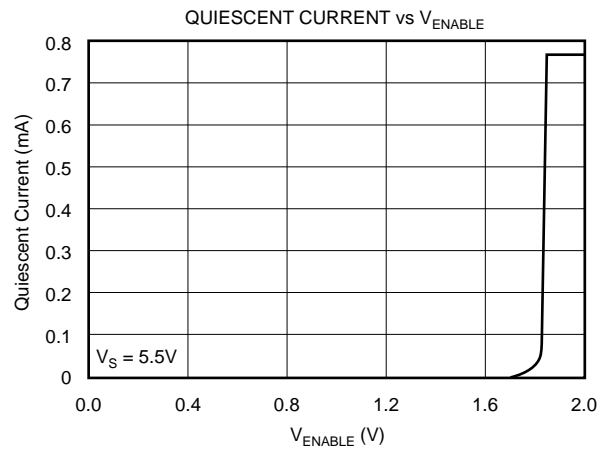
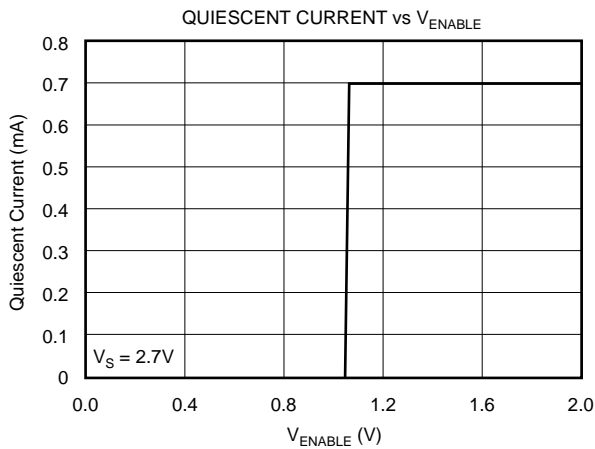
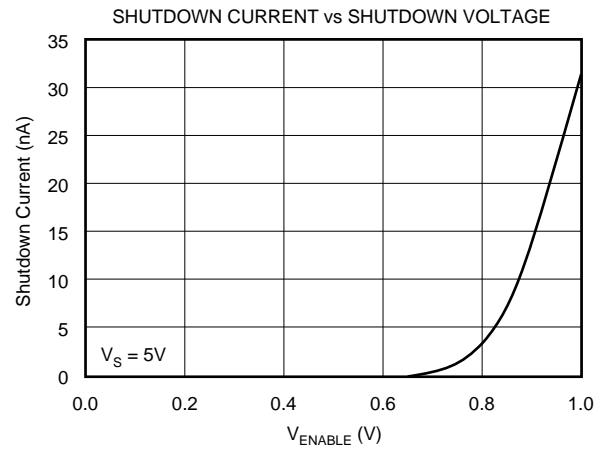
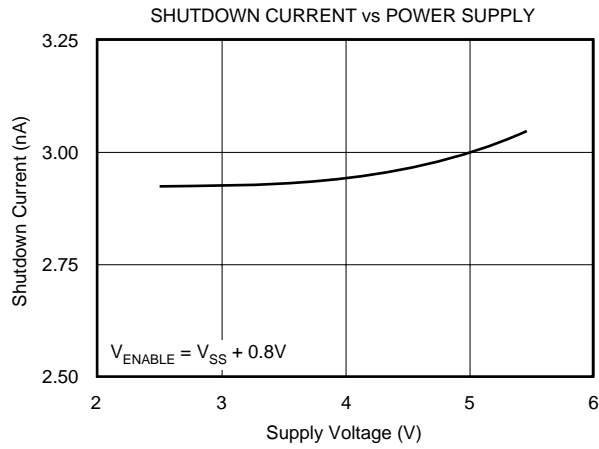
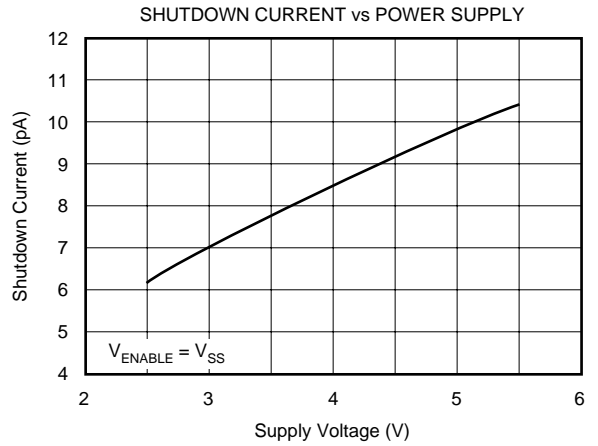
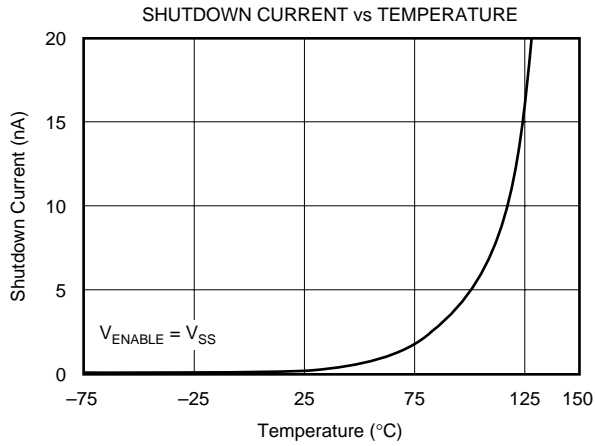

# TYPICAL CHARACTERISTICS (Cont.)

At  $T_A = +25^\circ\text{C}$ ,  $V_{\text{ENABLE}} = V_{\text{DD}}$ ,  $V_S = +5\text{V}$ ,  $R_L = 10\text{k}\Omega$ , unless otherwise noted.

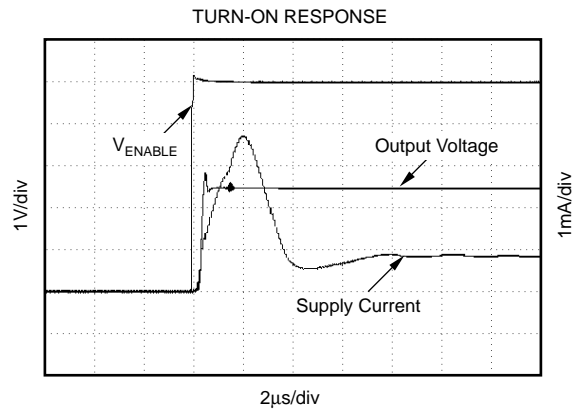
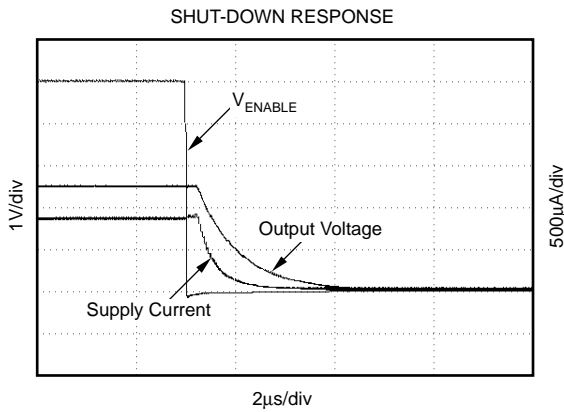
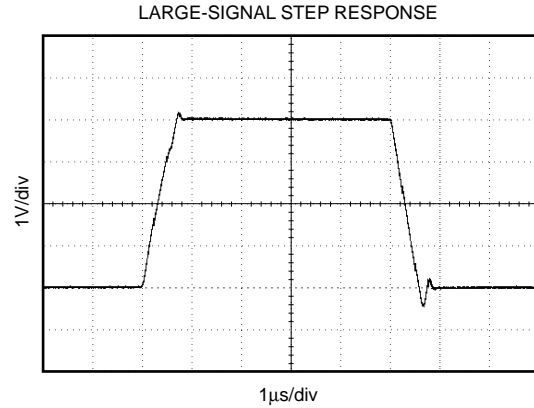
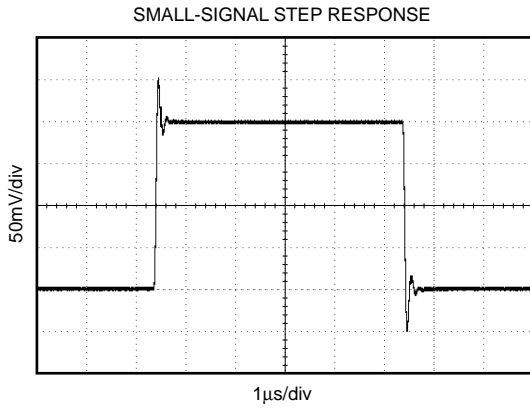
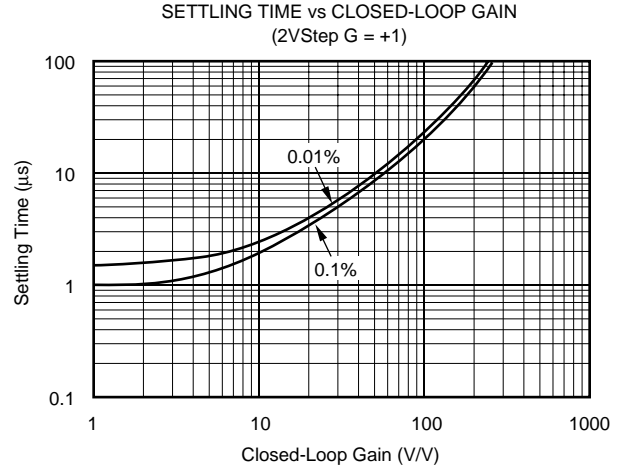
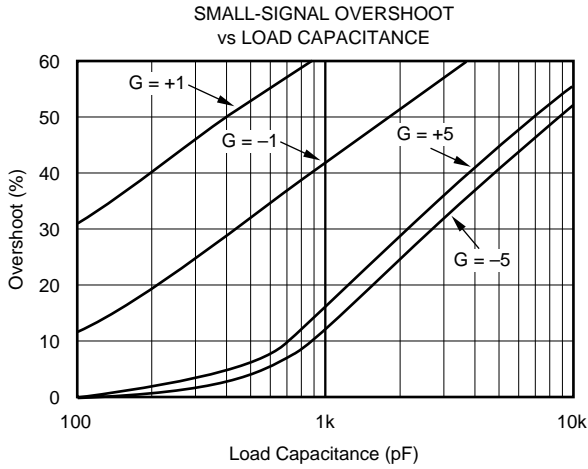



## APPLICATIONS INFORMATION

OPA341 series op amps are fabricated on a state-of-the-art 0.6-micron CMOS process. They are unity-gain stable and suitable for a wide range of general-purpose applications.

Rail-to-rail I/O make them ideal for driving sampling A/D converters. In addition, excellent ac performance makes them well suited for audio applications. The class AB output stage is capable of driving 600Ω loads connected to any point between  $V_+$  and ground. Rail-to-rail input and output swing significantly increases dynamic range, especially in low-supply applications. Figure 1 shows the input and output waveforms for the OPA341 in unity-gain configuration. Operation is from a single +5V supply with a 10kΩ load connected to  $V_S/2$ . The input is a 5Vp-p sinusoid. Output voltage is approximately 4.98Vp-p. Power-supply pins should be bypassed with 0.01μF ceramic capacitors.

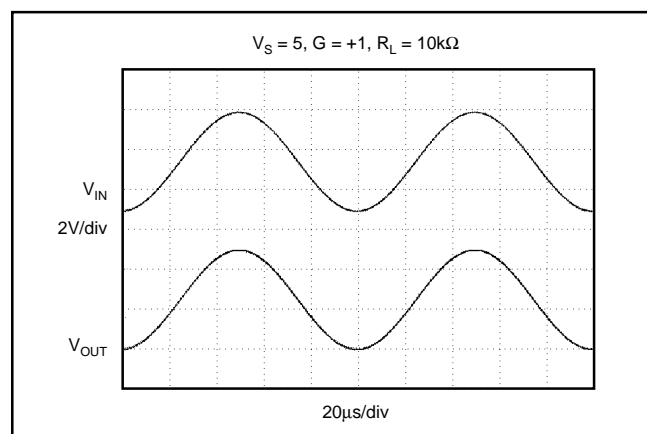

FIGURE 1. Rail-to-Rail Input and Output.

## OPERATING VOLTAGE

OPA341 series op amps are fully specified from +2.7V to +5.5V. However, supply voltage may range from +2.5V to +5.5V. Parameters are tested over the specified supply range—a unique feature of the OPA341 series. In addition, many specifications apply from  $-55^{\circ}\text{C}$  to  $+125^{\circ}\text{C}$ . Most behavior remains virtually unchanged throughout the full operating voltage range. Parameters that vary significantly with operating voltages or temperature are shown in the Typical Characteristics.

## RAIL-TO-RAIL INPUT

The input common-mode voltage range of the OPA341 series extends 300mV beyond the supply rails. This is achieved with a complementary input stage—an N-channel input differential pair in parallel with a P-channel differential pair, as shown in Figure 2. The N-channel pair is active for input voltages close to the positive rail, typically  $(V_+) - 1.3\text{V}$  to 300mV above the positive supply. The P-channel pair is on for inputs from 300mV below the negative supply to approximately  $(V_+) - 1.3\text{V}$ .

There is a small transition region, typically  $(V_+) - 1.5\text{V}$  to  $(V_+) - 1.1\text{V}$ , in which both input pairs are on. This 400mV transition region can vary  $\pm 300\text{mV}$  with process variation. Thus, the transition region (both stages on) can range from  $(V_+) - 1.8\text{V}$  to  $(V_+) - 1.4\text{V}$  on the low end, up to  $(V_+) - 1.2\text{V}$  to  $(V_+) - 0.8\text{V}$  on the high end. Within the 400mV transition region PSRR, CMRR, offset voltage, offset drift, and THD may be degraded compared to operation outside this region.

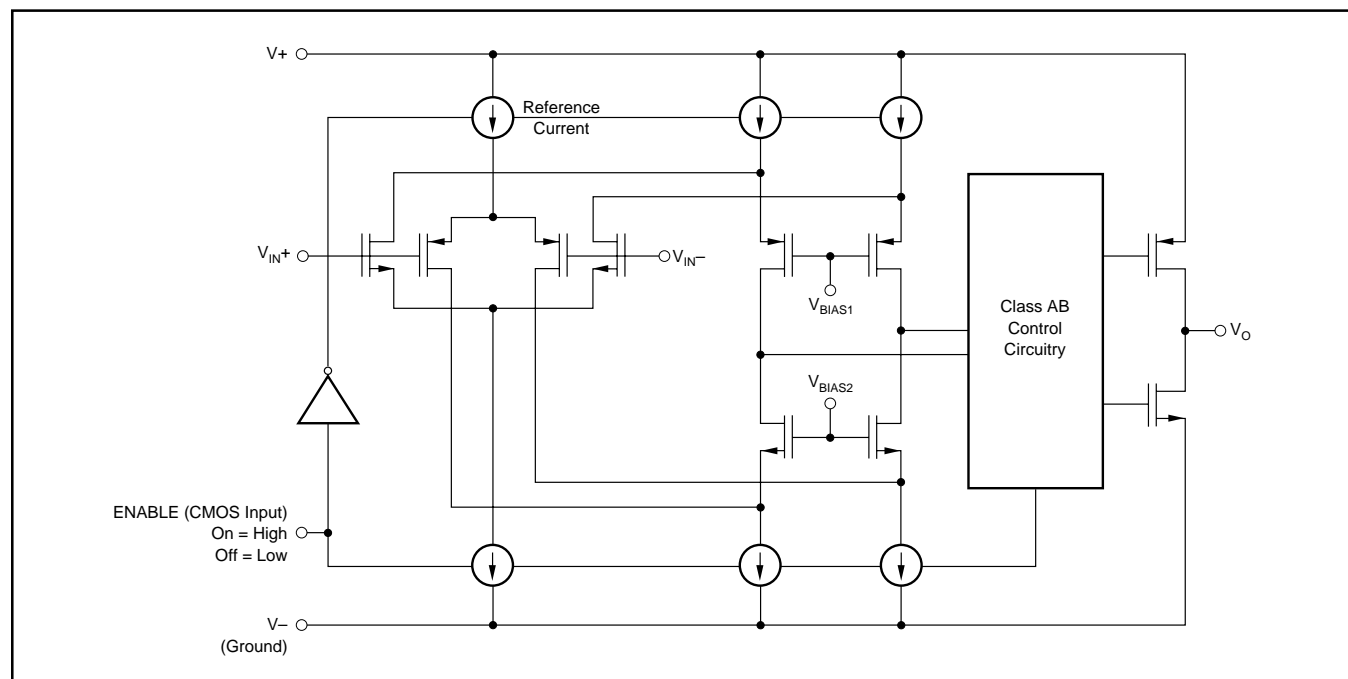

FIGURE 2. Simplified Schematic.

A double-folded cascode adds the signal from the two input pairs and presents a differential signal to the class AB output stage. Normally, input bias current is approximately 600fA, however, input voltages exceeding the power supplies by more than 300mV can cause excessive current to flow in or out of the input pins. Momentary voltages greater than 300mV beyond the power supply can be tolerated if the current on the input pins is limited to 10mA. This is easily accomplished with an input resistor, as shown in Figure 3. Many input signals are inherently current-limited to less than 10mA, therefore, a limiting resistor is not required.

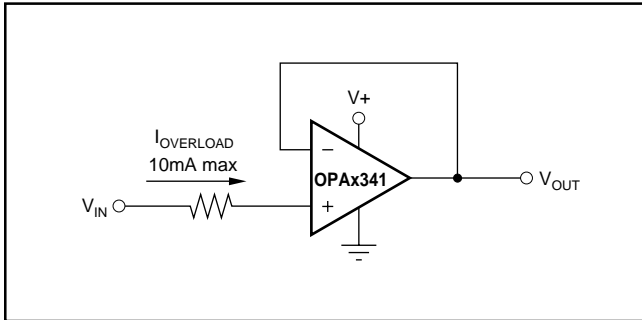

FIGURE 3. Input Current Protection for Voltages Exceeding the Supply Voltage.

### RAIL-TO-RAIL OUTPUT

A class AB output stage with common-source transistors is used to achieve rail-to-rail output. For light resistive loads ( $> 50k\Omega$ ), the output voltage is typically a few millivolts from the supply rails. With moderate resistive loads ( $2k\Omega$  to  $50k\Omega$ ), the output can swing to within a few tens of millivolts from the supply rails and maintain high open-loop gain. See the typical characteristic “Output Voltage Swing vs Output Current.”

### CAPACITIVE LOAD AND STABILITY

OPA341 series op amps can drive a wide range of capacitive loads. However, all op amps under certain conditions may become unstable. Op amp configurations, gain, and load value are just a few of the factors to consider when determining stability. An op amp in unity-gain configuration is the most susceptible to the effects of capacitive load. The

capacitive load reacts with the op amp’s output resistance, along with any additional load resistance, to create a pole in the small-signal response which degrades the phase margin. In unity gain, OPA341 series op amps perform well, with a pure capacitive load up to approximately 1000pF. Increasing gain enhances the amplifier’s ability to drive more capacitance. See the typical characteristic “Small-Signal Overshoot vs Capacitive Load.”

One method of improving capacitive load drive in the unity-gain configuration is to insert a  $10\Omega$  to  $20\Omega$  resistor in series with the output, as shown in Figure 4. This significantly reduces ringing with large capacitive loads. However, if there is a resistive load in parallel with the capacitive load,  $R_S$  creates a voltage divider. This introduces a DC error at the output and slightly reduces output swing. This error may be insignificant. For instance, with  $R_L = 10k\Omega$  and  $R_S = 20\Omega$ , there is only about a 0.2% error at the output.

### DRIVING A/D CONVERTERS

OPA341 series op amps are optimized for driving medium speed (up to 100kHz) sampling A/D converters. However, they also offer excellent performance for higher-speed converters. The OPA341 series provides an effective means of buffering the A/D converter’s input capacitance and resulting charge injection while providing signal gain. For applications requiring high accuracy, the OPA340 series is recommended.

The OPA341 implements a power-saving shutdown feature particularly useful for low-power sampling applications. Figure 5 shows the OPA341 driving the ADS7816, a 12-bit micro-power sampling converter available in the tiny MSOP-8 package. With the OPA341 in non-inverting configuration, an RC network at the amplifier’s output is used as an anti-aliasing filter. By tying the enable of the OPA341 to the shutdown of the ADS7816, additional power-savings can be used for sampling applications. To effectively drive the ADS7816, timing delay was introduced between the two devices, see Figure 5. Alternative applications may need additional timing adjustments.

Figure 6 shows the OPA341 configured as a speech band-pass filter. Figure 7 shows the OPA341 configured as a transimpedance amplifier.

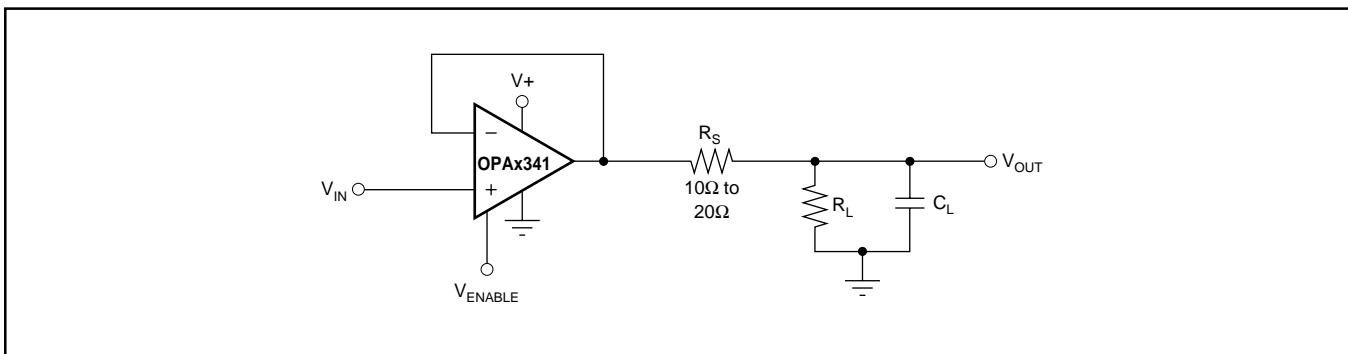

FIGURE 4. Series Resistor in Unity-Gain Configuration Improves Capacitive Load Drive.

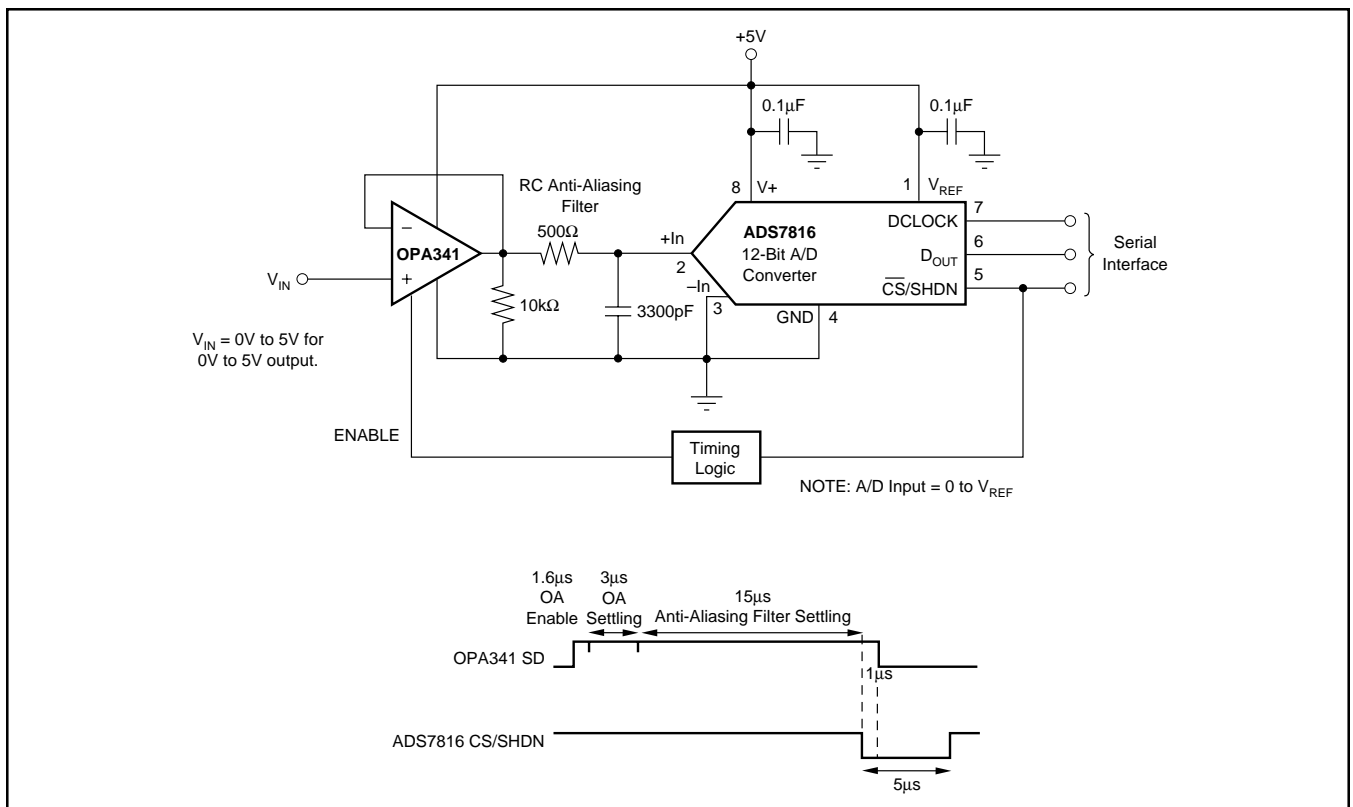

FIGURE 5. OPA341 in Noninverting Configuration Driving the ADS7816 with Timing Diagram.

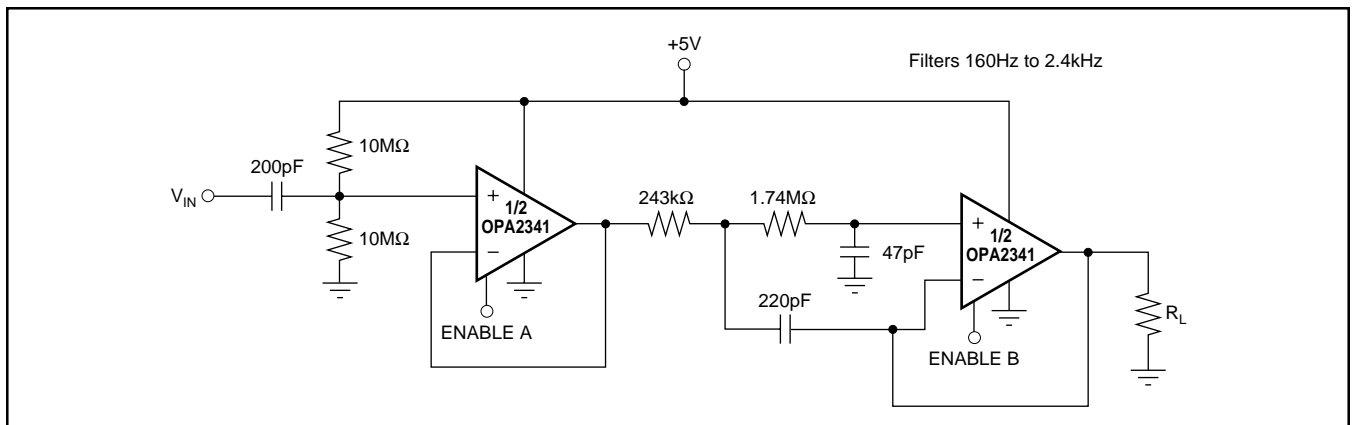

FIGURE 6. Speech Bandpass Filter.

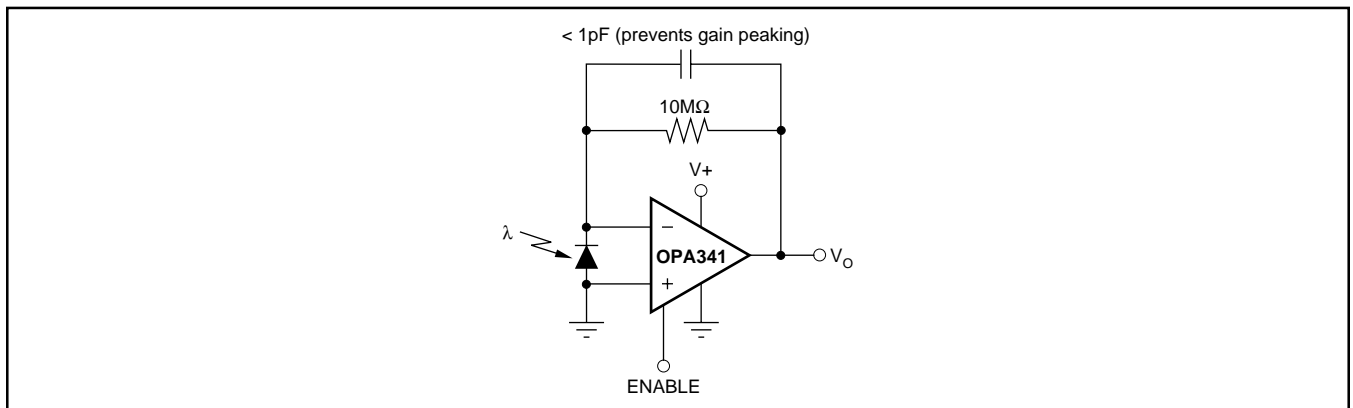

FIGURE 7. Transimpedance Amplifier.

**PACKAGING INFORMATION**

Orderable Device	Status (1)	Package Type	Package Drawing	Pins	Package Qty	Eco Plan (2)	Lead finish/ Ball material (6)	MSL Peak Temp (3)	Op Temp (°C)	Device Marking (4/5)	Samples
OPA2341DGSA/250	ACTIVE	VSSOP	DGS	10	250	RoHS & Green	Call TI   NIPDAUAG	Level-2-260C-1 YEAR	-55 to 125	C41	<a href="#">Samples</a>
OPA341NA/250	ACTIVE	SOT-23	DBV	6	250	RoHS & Green	NIPDAU	Level-2-260C-1 YEAR	-55 to 125	B41	<a href="#">Samples</a>
OPA341NA/250G4	ACTIVE	SOT-23	DBV	6	250	TBD	Call TI	Call TI	-55 to 125		<a href="#">Samples</a>
OPA341NA/3K	ACTIVE	SOT-23	DBV	6	3000	RoHS & Green	NIPDAU	Level-2-260C-1 YEAR	-55 to 125	B41	<a href="#">Samples</a>
OPA341UA	ACTIVE	SOIC	D	8	75	RoHS & Green	NIPDAU	Level-2-260C-1 YEAR	-55 to 125	OPA 341UA	<a href="#">Samples</a>

(1) The marketing status values are defined as follows:

**ACTIVE:** Product device recommended for new designs.

**LIFEBUY:** TI has announced that the device will be discontinued, and a lifetime-buy period is in effect.

**NRND:** Not recommended for new designs. Device is in production to support existing customers, but TI does not recommend using this part in a new design.

**PREVIEW:** Device has been announced but is not in production. Samples may or may not be available.

**OBSELETE:** TI has discontinued the production of the device.

(2) **RoHS:** TI defines "RoHS" to mean semiconductor products that are compliant with the current EU RoHS requirements for all 10 RoHS substances, including the requirement that RoHS substance do not exceed 0.1% by weight in homogeneous materials. Where designed to be soldered at high temperatures, "RoHS" products are suitable for use in specified lead-free processes. TI may reference these types of products as "Pb-Free".

**RoHS Exempt:** TI defines "RoHS Exempt" to mean products that contain lead but are compliant with EU RoHS pursuant to a specific EU RoHS exemption.

**Green:** TI defines "Green" to mean the content of Chlorine (Cl) and Bromine (Br) based flame retardants meet JS709B low halogen requirements of <=1000ppm threshold. Antimony trioxide based flame retardants must also meet the <=1000ppm threshold requirement.

(3) MSL, Peak Temp. - The Moisture Sensitivity Level rating according to the JEDEC industry standard classifications, and peak solder temperature.

(4) There may be additional marking, which relates to the logo, the lot trace code information, or the environmental category on the device.

(5) Multiple Device Markings will be inside parentheses. Only one Device Marking contained in parentheses and separated by a "~" will appear on a device. If a line is indented then it is a continuation of the previous line and the two combined represent the entire Device Marking for that device.

(6) Lead finish/Ball material - Orderable Devices may have multiple material finish options. Finish options are separated by a vertical ruled line. Lead finish/Ball material values may wrap to two lines if the finish value exceeds the maximum column width.

**Important Information and Disclaimer:** The information provided on this page represents TI's knowledge and belief as of the date that it is provided. TI bases its knowledge and belief on information provided by third parties, and makes no representation or warranty as to the accuracy of such information. Efforts are underway to better integrate information from third parties. TI has taken and continues to take reasonable steps to provide representative and accurate information but may not have conducted destructive testing or chemical analysis on incoming materials and chemicals. TI and TI suppliers consider certain information to be proprietary, and thus CAS numbers and other limited information may not be available for release.

In no event shall TI's liability arising out of such information exceed the total purchase price of the TI part(s) at issue in this document sold by TI to Customer on an annual basis.

**TAPE AND REEL INFORMATION**

**QUADRANT ASSIGNMENTS FOR PIN 1 ORIENTATION IN TAPE**



\*All dimensions are nominal

Device	Package Type	Package Drawing	Pins	SPQ	Reel Diameter (mm)	Reel Width W1 (mm)	A0 (mm)	B0 (mm)	K0 (mm)	P1 (mm)	W (mm)	Pin1 Quadrant
OPA341NA/250	SOT-23	DBV	6	250	178.0	9.0	3.23	3.17	1.37	4.0	8.0	Q3
OPA341NA/3K	SOT-23	DBV	6	3000	178.0	9.0	3.23	3.17	1.37	4.0	8.0	Q3

**TAPE AND REEL BOX DIMENSIONS**

\*All dimensions are nominal

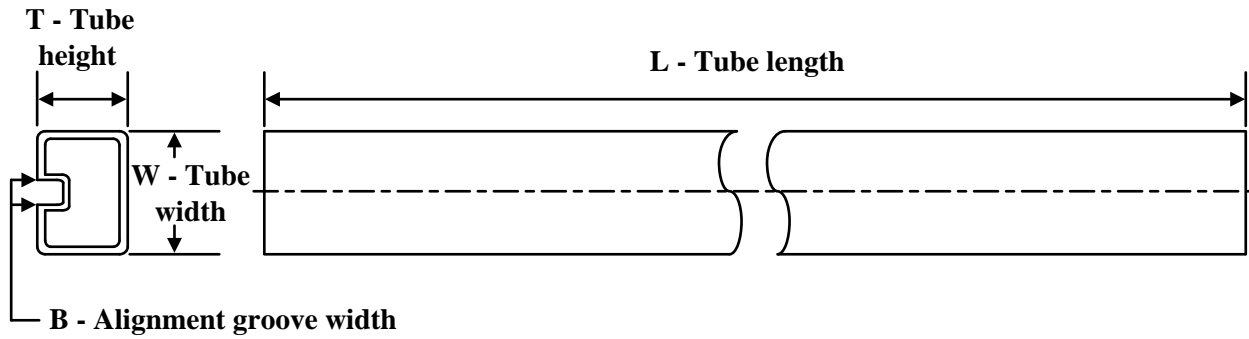
Device	Package Type	Package Drawing	Pins	SPQ	Length (mm)	Width (mm)	Height (mm)
OPA341NA/250	SOT-23	DBV	6	250	445.0	220.0	345.0
OPA341NA/3K	SOT-23	DBV	6	3000	445.0	220.0	345.0

**TUBE**

\*All dimensions are nominal

Device	Package Name	Package Type	Pins	SPQ	L (mm)	W (mm)	T (μm)	B (mm)
OPA341UA	D	SOIC	8	75	506.6	8	3940	4.32



## IMPORTANT NOTICE AND DISCLAIMER

TI PROVIDES TECHNICAL AND RELIABILITY DATA (INCLUDING DATA SHEETS), DESIGN RESOURCES (INCLUDING REFERENCE DESIGNS), APPLICATION OR OTHER DESIGN ADVICE, WEB TOOLS, SAFETY INFORMATION, AND OTHER RESOURCES "AS IS" AND WITH ALL FAULTS, AND DISCLAIMS ALL WARRANTIES, EXPRESS AND IMPLIED, INCLUDING WITHOUT LIMITATION ANY IMPLIED WARRANTIES OF MERCHANTABILITY, FITNESS FOR A PARTICULAR PURPOSE OR NON-INFRINGEMENT OF THIRD PARTY INTELLECTUAL PROPERTY RIGHTS.

These resources are intended for skilled developers designing with TI products. You are solely responsible for (1) selecting the appropriate TI products for your application, (2) designing, validating and testing your application, and (3) ensuring your application meets applicable standards, and any other safety, security, regulatory or other requirements.

These resources are subject to change without notice. TI grants you permission to use these resources only for development of an application that uses the TI products described in the resource. Other reproduction and display of these resources is prohibited. No license is granted to any other TI intellectual property right or to any third party intellectual property right. TI disclaims responsibility for, and you will fully indemnify TI and its representatives against, any claims, damages, costs, losses, and liabilities arising out of your use of these resources.

TI's products are provided subject to [TI's Terms of Sale](#) or other applicable terms available either on [ti.com](http://ti.com) or provided in conjunction with such TI products. TI's provision of these resources does not expand or otherwise alter TI's applicable warranties or warranty disclaimers for TI products.

TI objects to and rejects any additional or different terms you may have proposed.

Mailing Address: Texas Instruments, Post Office Box 655303, Dallas, Texas 75265  
Copyright © 2022, Texas Instruments Incorporated