

## STEREO AUDIO CODEC WITH USB INTERFACE, SINGLE-ENDED ANALOG INPUT/OUTPUT AND S/PDIF

### FEATURES

- **PCM2901: Without S/PDIF**
- **PCM2903: With S/PDIF**
- **On-Chip USB Interface**
  - With Full-Speed Transceivers
  - Fully Compliant With USB 1.1 Specification
  - Certified by USB-IF
  - Partially Programmable Descriptors <sup>(1)</sup>
  - USB Adaptive Mode for Playback
  - USB Asynchronous Mode for Record
  - Self-Powered
- **16-Bit Delta-Sigma ADC and DAC**
- **Sampling Rates**
  - DAC: 32, 44.1, 48 kHz
  - ADC: 8, 11.025, 16, 22.05, 32, 44.1, 48 kHz
- **On-Chip Clock Generator With Single 12-MHz Clock Source**
- **Single Power Supply: 3.3 V Typical**
- **Stereo ADC**
  - Analog Performance at  $V_{CC} = V_{CCP1} = V_{CCP2} = V_{CCX} = V_{DD} = 3.3\text{ V}$ 
    - THD+N = 0.01%
    - SNR = 89 dB
    - Dynamic Range = 89 dB
  - Decimation Digital Filter
    - Pass-Band Ripple =  $\pm 0.05\text{ dB}$
    - Stop-Band Attenuation =  $-65\text{ dB}$
  - Single-Ended Voltage Input
  - Antialiasing Filter Included
  - Digital LCF Included
- **Stereo DAC**
  - Analog Performance at  $V_{CC} = V_{CCP1} = V_{CCP2} = V_{CCX} = V_{DD} = 3.3\text{ V}$ 
    - THD+N = 0.005%
    - SNR = 96 dB
    - Dynamic Range = 93 dB
  - Oversampling Digital Filter
    - Pass-Band Ripple =  $\pm 0.1\text{ dB}$
    - Stop-Band Attenuation =  $-43\text{ dB}$
  - Single-Ended Voltage Output
  - Analog LPF Included
- **Multifunctions**
  - Human Interface Device (HID) Volume  $\pm$  Control and Mute Control
  - Suspend Flag
- **Package: 28-Pin SSOP**

### APPLICATIONS

- USB Audio Speaker
- USB Headset
- USB Monitor
- USB Audio Interface Box

### DESCRIPTION

The PCM2901/2903 is TI's single-chip USB stereo audio codec with USB-compliant full-speed protocol controller and S/PDIF (only PCM2903). The USB protocol controller works with no software code, but the USB descriptors can be modified in some areas (for example, vendor ID/product ID). The PCM2901/2903 employs SpAct™ architecture, TI's unique system that recovers the audio clock from USB packet data. On-chip analog PLLs with SpAct enable playback and record with low clock jitter and with independent playback and record sampling rates.

(1) The descriptor can be modified by changing a mask.



Please be aware that an important notice concerning availability, standard warranty, and use in critical applications of Texas Instruments semiconductor products and disclaimers thereto appears at the end of this data sheet.

SpAct is a trademark of Texas Instruments.

System Two, Audio Precision are trademarks of Audio Precision, Inc.

All other trademarks are the property of their respective owners.



This integrated circuit can be damaged by ESD. Texas Instruments recommends that all integrated circuits be handled with appropriate precautions. Failure to observe proper handling and installation procedures can cause damage.

ESD damage can range from subtle performance degradation to complete device failure. Precision integrated circuits may be more susceptible to damage because very small parametric changes could cause the device not to meet its published specifications.

### ORDERING INFORMATION

PCM2901						
PRODUCT	PACKAGE-LEAD	PACKAGE DESIGNATOR	SPECIFIED TEMPERATURE RANGE	PACKAGE MARKING	ORDERING NUMBER <sup>(1)</sup>	TRANSPORT MEDIA
PCM2901E	SSOP-28	28DB	–25°C to 85°C	PCM2901E	PCM2901E	Rails
					PCM2903E/2K	Tape and reel

(1) Models with a slash (/) are available only in tape and reel in the quantities indicated (e.g., /2K indicates 2000 devices per reel). Ordering 2000 pieces of PCM2901E/2K gets a single 2000-piece tape and reel.

PCM2903						
PRODUCT	PACKAGE-LEAD	PACKAGE DESIGNATOR	SPECIFIED TEMPERATURE RANGE	PACKAGE MARKING	ORDERING NUMBER <sup>(1)</sup>	TRANSPORT MEDIA
PCM2903E	SSOP-28	28DB	–25°C to 85°C	PCM2903E	PCM2903E	Rails
					PCM2903E/2K	Tape and reel

(1) Models with a slash (/) are available only in tape and reel in the quantities indicated (e.g., /2K indicates 2000 devices per reel). Ordering 2000 pieces of PCM2903E/2K gets a single 2000-piece tape and reel.

### ABSOLUTE MAXIMUM RATINGS

over operating free-air temperature range (unless otherwise noted) <sup>(1)</sup>

		PCM2901/PCM2903	UNIT
Supply voltage, $V_{CC}$ , $V_{CCP1}$ , $V_{CCP2}$ , $V_{CCX}$ , $V_{DD}$		–0.3 to 4	V
Supply voltage differences, $V_{CC}$ , $V_{CCP1}$ , $V_{CCP2}$ , $V_{CCX}$ , $V_{DD}$		±0.1	V
Ground voltage differences, AGNDC, AGNDP, AGNDX, DGND, DGNDU		±0.1	V
Digital input voltage	SEL0, SEL1, TEST0 (DIN) <sup>(2)</sup>	–0.3 to 6.5	V
	D+, D–, HID0, HID1, HID2, XTI, XTO, TEST1 (DOUT) <sup>(2)</sup> , $\overline{SSPND}$	–0.3 to $(V_{DD} + 0.3) < 4$	V
Analog input voltage $V_{INL}$ , $V_{INR}$ , $V_{COM}$ , $V_{OUTR}$ , $V_{OUTL}$		–0.3 to $(V_{CC} + 0.3) < 4$	V
Input current (any pins except supplies)		±10	mA
Ambient temperature under bias		–40 to 125	°C
Storage temperature, $T_{stg}$		–55 to 150	°C
Junction temperature $T_J$		150	°C
Lead temperature (soldering)		260	°C, 5 s
Package temperature (IR reflow, peak)		250	°C

(1) Stresses beyond those listed under *absolute maximum ratings* may cause permanent damage to the device. These are stress ratings only, and functional operation of the device at these or any other conditions beyond those indicated under *recommended operating conditions* is not implied. Exposure to absolute-maximum-rated conditions for extended periods may affect device reliability.

(2) ( ): PCM2903

## ELECTRICAL CHARACTERISTICS

all specifications at  $T_A = 25^\circ\text{C}$ ,  $V_{\text{CCC}} = V_{\text{CCP1}} = V_{\text{CCP2}} = V_{\text{CCX}} = V_{\text{DD}} = 3.3\text{ V}$ ,  $f_S = 44.1\text{ kHz}$ ,  $f_{\text{IN}} = 1\text{ kHz}$ , 16-bit data, unless otherwise noted

PARAMETER		TEST CONDITIONS	MIN	TYP	MAX	UNIT
<b>DIGITAL INPUT/OUTPUT</b>						
Host interface		Apply USB Revision 1.1, full speed				
Audio data format		USB isochronous data format				
<b>INPUT LOGIC</b>						
$V_{\text{IH}}$	High-level input voltage	D+, D–	2		$V_{\text{DD}}$	VDC
		XTI, HID0, HID1, and HID2	$0.7 V_{\text{DD}}$		$V_{\text{DD}}$	
		SEL0, SEL1	2		5.25	
		DIN (PCM2903)	$0.7 V_{\text{DD}}$		5.25	
$V_{\text{IL}}$	Low-level input voltage	D+, D–	$V_{\text{DD}}$		0.8	VDC
		XTI, HID0, HID1, and HID2			$0.3 V_{\text{DD}}$	
		SEL0, SEL1			0.8	
		DIN (PCM2903)			$0.3 V_{\text{DD}}$	
$I_{\text{IH}}$	High-level input current	D+, D–, XTI, SEL0, SEL1	$V_{\text{IN}} = 3.3\text{ V}$		$\pm 10$	$\mu\text{A}$
		HID0, HID1, and HID2	$V_{\text{IN}} = 3.3\text{ V}$		50 80	
		DIN (PCM2903)	$V_{\text{IN}} = 3.3\text{ V}$		65 100	
$I_{\text{IL}}$	Low-level input current	D+, D–, XTI, SEL0, SEL1	$V_{\text{IN}} = 0\text{ V}$		$\pm 10$	$\mu\text{A}$
		HID0, HID1, and HID2	$V_{\text{IN}} = 0\text{ V}$		$\pm 10$	
		DIN (PCM2903)	$V_{\text{IN}} = 0\text{ V}$		$\pm 10$	
<b>OUTPUT LOGIC</b>						
$V_{\text{OH}}$	High-level output voltage	D+, D–		2.8		VDC
		DOUT (PCM2903)	$I_{\text{OH}} = -4\text{ mA}$	2.8		
		SSPND	$I_{\text{OH}} = -2\text{ mA}$	2.8		
$V_{\text{OL}}$	Low-level output voltage	D+, D–			0.3	VDC
		DOUT (PCM2903)	$I_{\text{OL}} = 4\text{ mA}$		0.5	
		SSPND	$I_{\text{OL}} = 2\text{ mA}$		0.5	
<b>CLOCK FREQUENCY</b>						
Input clock frequency, XTI			11.994	12	12.006	MHz

## ELECTRICAL CHARACTERISTICS

All specifications at  $T_A = 25^\circ\text{C}$ ,  $V_{\text{CC}} = V_{\text{CCP1}} = V_{\text{CCP2}} = V_{\text{CCX}} = V_{\text{DD}} = 3.3\text{ V}$ ,  $f_S = 44.1\text{ kHz}$ ,  $f_{\text{IN}} = 1\text{ kHz}$ , 16-bit data, unless otherwise noted

PARAMETER		TEST CONDITIONS	MIN	TYP	MAX	UNIT
<b>ADC CHARACTERISTICS</b>						
Resolution				8, 16		bits
Audio data channel				1, 2		channel
<b>Clock Frequency</b>						
$f_S$	Sampling frequencies		8, 11.025, 16, 22.05, 32, 44.1, 48			kHz
<b>DC Accuracy</b>						
Gain mismatch, channel-to-channel				$\pm 1$	$\pm 5$	% of FSR
Gain error				$\pm 2$	$\pm 10$	% of FSR
Bipolar zero error				$\pm 0$		% of FSR
<b>Dynamic Performance<sup>(1)</sup></b>						
THD+N	Total harmonic distortion plus noise	$V_{\text{IN}} = -0.5\text{ dB}$		0.01%	0.02%	
		$V_{\text{IN}} = -60\text{ dB}$		5%		
Dynamic range		A-weighted	81	89		dB
SNR	Signal-to-noise ratio	A-weighted	81	89		dB
Channel separation			80	85		dB
<b>Analog Input</b>						
Input voltage				$0.6 V_{\text{CC}}$		Vp-p
Center voltage				$0.5 V_{\text{CC}}$		V
Input impedance				30		k $\Omega$
Antialiasing filter frequency response		-3 dB		150		kHz
		$f_{\text{IN}} = 20\text{ kHz}$		-0.08		dB
<b>Digital Filter Performance</b>						
Pass band					$0.454 f_S$	Hz
Stop band			$0.563 f_S$			Hz
Pass-band ripple					$\pm 0.05$	dB
Stop-band attenuation			-65			dB
$t_d$	Delay time			$17.4/f_S$		s
LCF frequency response		-3 dB		$0.078 f_S$		MHz

(1)  $f_{\text{IN}} = 1\text{ kHz}$ , using a System Two™ audio measurement system by Audio Precision™ in RMS mode with a 20-kHz LPF and 400-Hz HPF in the calculation.

## ELECTRICAL CHARACTERISTICS

all specifications at  $T_A = 25^\circ\text{C}$ ,  $V_{\text{CC}} = V_{\text{CCP1}} = V_{\text{CCP2}} = V_{\text{CCX}} = V_{\text{DD}} = 3.3\text{ V}$ ,  $f_S = 44.1\text{ kHz}$ ,  $f_{\text{IN}} = 1\text{ kHz}$ , 16-bit data, unless otherwise noted

PARAMETER		TEST CONDITIONS	MIN	TYP	MAX	UNIT
<b>DAC CHARACTERISTICS</b>						
	Resolution			8, 16		bits
	Audio data channel			1, 2		channel
<b>Clock Frequency</b>						
$f_S$	Sampling frequencies			32, 44.1, 48		kHz
<b>DC Accuracy</b>						
	Gain mismatch channel-to-channel			$\pm 1$	$\pm 5$	% of FSR
	Gain error			$\pm 2$	$\pm 10$	% of FSR
	Bipolar zero error			$\pm 2$		% of FSR
<b>Dynamic Performance<sup>(1)</sup></b>						
THD+N	Total harmonic distortion plus noise	$V_{\text{OUT}} = 0\text{ dB}$		0.005%	0.016%	
		$V_{\text{OUT}} = -60\text{ dB}$		3%		
	Dynamic range	EIAJ, A-weighted	87	93		dB
SNR	Signal-to-noise ratio	EIAJ, A-weighted	90	96		dB
	Channel separation		86	92		dB
<b>Analog Output</b>						
$V_O$	Output voltage			$0.6 V_{\text{CC}}$		Vp-p
	Center voltage			$0.5 V_{\text{CC}}$		V
	Load impedance	AC coupling	10			k $\Omega$
	LPF frequency response	-3 dB		250		kHz
		$f = 20\text{ kHz}$		-0.03		dB
<b>Digital Filter Performance</b>						
	Pass band				$0.445 f_S$	Hz
	Stop band		$0.555 f_S$			Hz
	Pass-band ripple				$\pm 0.1$	dB
	Stop-band attenuation		-43			dB
$t_d$	Delay time				$14.3/f_S$	s
<b>POWER SUPPLY REQUIREMENTS</b>						
	Voltage range ( $V_{\text{DD}}$ , $V_{\text{CC}}$ , $V_{\text{CCP1}}$ , $V_{\text{CCP2}}$ , $V_{\text{CCX}}$ )		3	3.3	3.6	VDC
	Supply current	ADC, DAC operation		54	70	mA
		Suspend mode <sup>(2)</sup>		210		$\mu\text{A}$
$P_D$	Power dissipation	ADC, DAC operation		178	252	mW
		Suspend mode <sup>(2)</sup>		0.69		
<b>TEMPERATURE RANGE</b>						
	Operaton temperature		-25		85	$^\circ\text{C}$
$\theta_{\text{JA}}$	Thermal resistance			100		$^\circ\text{C/W}$

(1)  $f_{\text{OUT}} = 1\text{ kHz}$ , using a System Two audio measurement system by Audio Precision in RMS mode with a 20-kHz LPF and 400-Hz HPF.

(2) Under USB suspend state

**PIN ASSIGNMENTS**

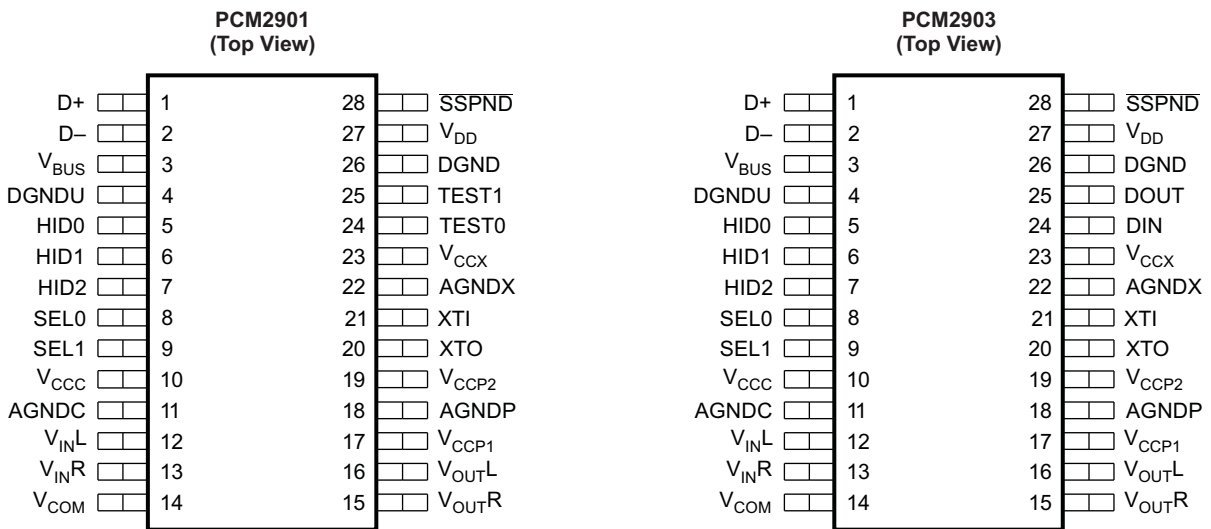

P0007-07

**PCM2901 TERMINAL FUNCTIONS**

TERMINAL		I/O	DESCRIPTION
NAME	NO.		
AGNDC	11	–	Analog ground for codec
AGNDP	18	–	Analog ground for PLL
AGNDX	22	–	Analog ground for oscillator
D–	2	I/O	USB differential input/output minus <sup>(1)</sup>
D+	1	I/O	USB differential input/output plus <sup>(1)</sup>
DGND	26	–	Digital ground
DGNDU	4	–	Digital ground for USB transceiver
HID0	5	I	HID key state input (mute), active-high <sup>(2)</sup>
HID1	6	I	HID key state input (volume up), active-high <sup>(2)</sup>
HID2	7	I	HID key state input (volume down), active-high <sup>(2)</sup>
SEL0	8	I	Must be set to high <sup>(3)</sup>
SEL1	9	I	Connected to the USB port of V <sub>BUS</sub> <sup>(3)</sup>
SSPND	28	O	Suspend flag, active-low (Low: suspend, High: operational)
TEST0	24	I	Test pin, must be connected to GND
TEST1	25	O	Test pin, must be left open
V <sub>BUS</sub>	3	–	Must be connected to V <sub>DD</sub>
V <sub>CC</sub>	10	–	Analog power supply for codec <sup>(4)</sup>
V <sub>CCP1</sub>	17	–	Analog power supply for PLL <sup>(4)</sup>
V <sub>CCP2</sub>	19	–	Analog power supply for PLL <sup>(4)</sup>
V <sub>CCX</sub>	23	–	Analog power supply for oscillator <sup>(4)</sup>
V <sub>COM</sub>	14	–	Common for ADC/DAC (V <sub>CC</sub> /2) <sup>(4)</sup>
V <sub>DD</sub>	27	–	Digital power supply <sup>(4)</sup>
V <sub>INL</sub>	12	I	ADC analog input for L-channel
V <sub>INR</sub>	13	I	ADC analog input for R-channel
V <sub>OUTL</sub>	16	O	DAC analog output for L-channel
V <sub>OUTR</sub>	15	O	DAC analog output for R-channel
XTI	21	I	Crystal oscillator input <sup>(5)</sup>
XTO	20	O	Crystal oscillator output

(1) LV-TTL level

(2) 3.3-V CMOS-level input with internal pulldown. This pin informs the PC of serviceable control signals such as mute, volume up, or volume down, which have no direct connection with the internal DAC or ADC. See the [Interface #3](#) and [End-Points](#) sections.

(3) TTL Schmitt trigger, 5-V tolerant

(4) Connect a decoupling capacitor to GND.

(5) 3.3-V CMO- level input

PCM2903 TERMINAL FUNCTIONS

TERMINAL		I/O	DESCRIPTION
NAME	NO.		
AGNDC	11	–	Analog ground for codec
AGNDP	18	–	Analog ground for PLL
AGNDX	22	–	Analog ground for oscillator
D–	2	I/O	USB differential input/output minus <sup>(1)</sup>
D+	1	I/O	USB differential input/output plus <sup>(1)</sup>
DGND	26	–	Digital ground
DGNDU	4	–	Digital ground for USB transceiver
DIN	24	I	S/PDIF input <sup>(2)</sup>
DOUT	25	O	S/PDIF output
HID0	5	I	HID key state input (mute), active-high <sup>(3)</sup>
HID1	6	I	HID key state input (volume up), active-high <sup>(3)</sup>
HID2	7	I	HID key state input (volume down), active-high <sup>(3)</sup>
SEL0	8	I	Must be set to high <sup>(4)</sup>
SEL1	9	I	Connected to the USB port of V <sub>BUS</sub> <sup>(4)</sup>
$\overline{\text{SSPND}}$	28	O	Suspend flag, active-low (Low: suspend, High: operational)
V <sub>BUS</sub>	3	–	Must be connected to V <sub>DD</sub>
V <sub>CC</sub>	10	–	Analog power supply for codec <sup>(5)</sup>
V <sub>CCP1</sub>	17	–	Analog power supply for PLL <sup>(5)</sup>
V <sub>CCP2</sub>	19	–	Analog power supply for PLL <sup>(5)</sup>
V <sub>CCX</sub>	23	–	Analog power supply for oscillator <sup>(5)</sup>
V <sub>COM</sub>	14	–	Common for ADC/DAC (V <sub>CC</sub> /2) <sup>(5)</sup>
V <sub>DD</sub>	27	–	Digital power supply <sup>(5)</sup>
V <sub>INL</sub>	12	I	ADC analog input for L-channel
V <sub>INR</sub>	13	I	ADC analog input for R-channel
V <sub>OUTL</sub>	16	O	DAC analog output for L-channel
V <sub>OUTR</sub>	15	O	DAC analog output for R-channel
XTI	21	I	Crystal oscillator input <sup>(6)</sup>
XTO	20	O	Crystal oscillator output

- (1) LV-TTL level
- (2) 3.3-V CMOS-level input with internal pulldown, 5-V tolerant
- (3) 3.3-V CMOS-level input with internal pulldown. This pin informs the PC of serviceable control signals such as mute, volume up, or volume down, which have no direct connection with the internal DAC or ADC. See the [Interface #3](#) and [End-Points](#) sections.
- (4) TTL Schmitt trigger, 5-V tolerant
- (5) Connect a decoupling capacitor to GND.
- (6) 3.3-V CMOS-level input



**PCM2901 FUNCTIONAL BLOCK DIAGRAM**

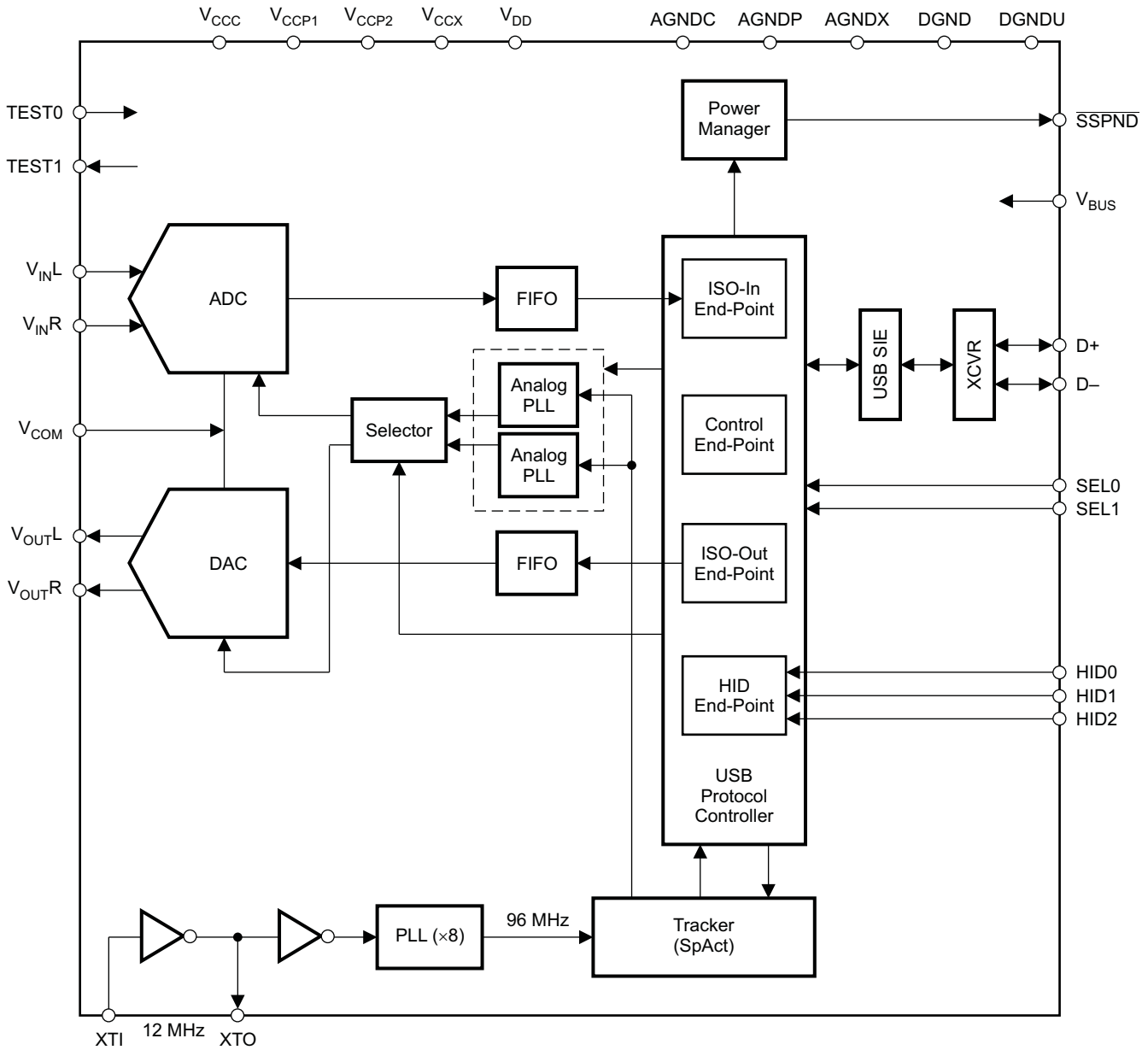

B0238-02



**PCM2901/2903 BLOCK DIAGRAM OF ANALOG FRONT-END (RIGHT CHANNEL)**

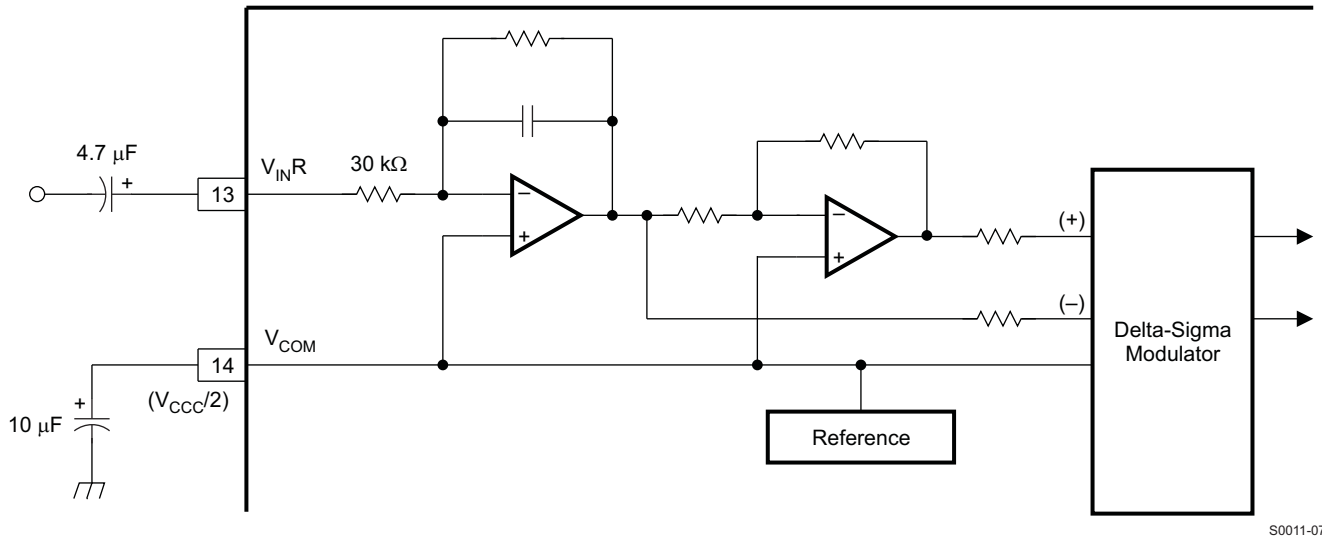

**TYPICAL CHARACTERISTICS**

All specifications at  $T_A = 25^\circ\text{C}$ ,  $V_{DD} = V_{CC} = V_{CCP1} = V_{CCP2} = V_{CCx} = 3.3\text{ V}$ ,  $f_s = 44.1\text{ kHz}$ ,  $f_{IN} = 1\text{ kHz}$ , 16-bit data, unless otherwise noted.

**ADC**

**TOTAL HARMONIC DISTORTION + NOISE at -0.5 dB  
vs  
FREE-AIR TEMPERATURE**

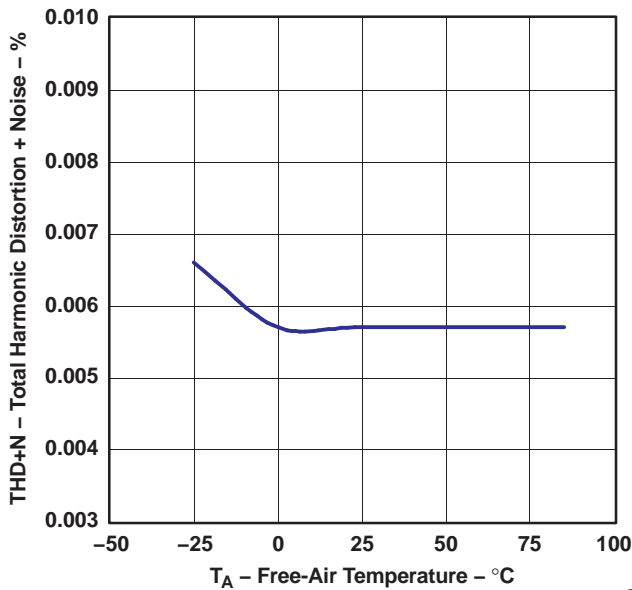

Figure 1.

**DYNAMIC RANGE and SNR  
vs  
FREE-AIR TEMPERATURE**

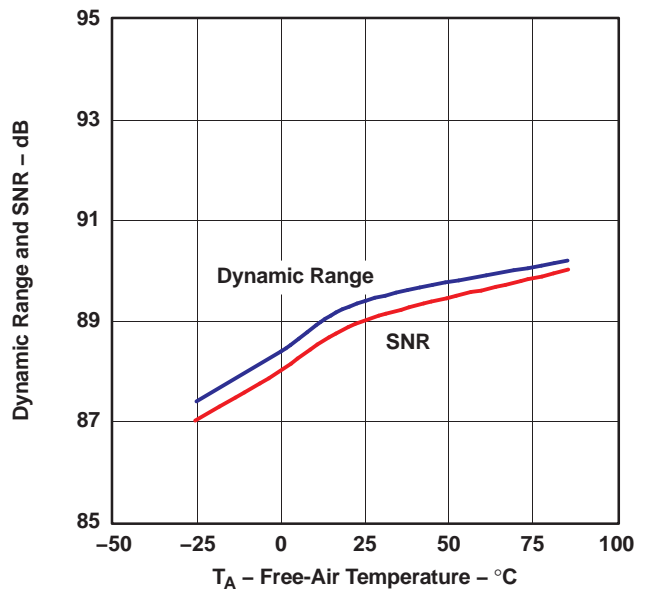
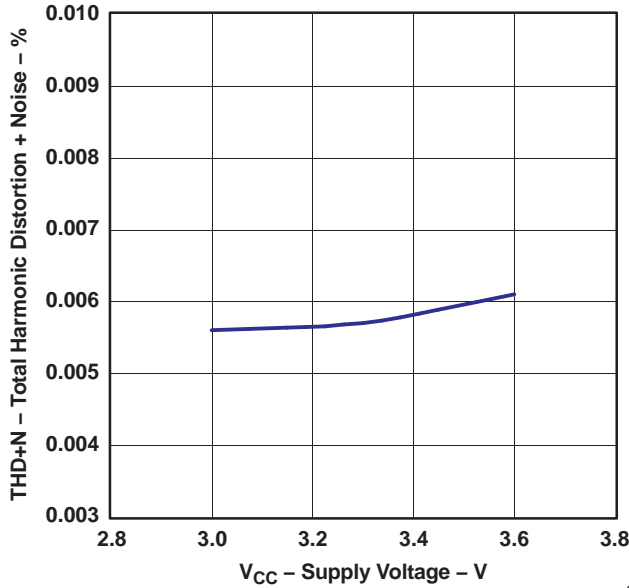

Figure 2.

**TYPICAL CHARACTERISTICS (continued)**

All specifications at  $T_A = 25^\circ\text{C}$ ,  $V_{DD} = V_{CC} = V_{CCP1} = V_{CCP2} = V_{CCx} = 3.3\text{ V}$ ,  $f_s = 44.1\text{ kHz}$ ,  $f_{IN} = 1\text{ kHz}$ , 16-bit data, unless otherwise noted.

**TOTAL HARMONIC DISTORTION + NOISE at -0.5 dB  
vs  
SUPPLY VOLTAGE**



G003

Figure 3.

**DYNAMIC RANGE and SNR  
vs  
SUPPLY VOLTAGE**

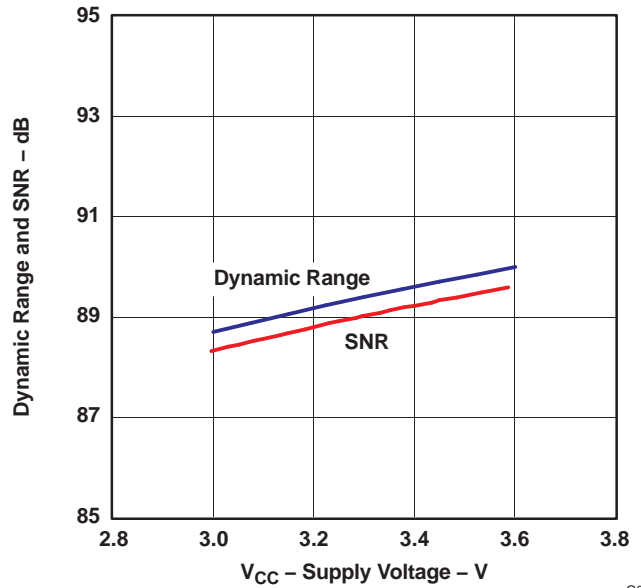

G004

Figure 4.

**TOTAL HARMONIC DISTORTION + NOISE at -0.5 dB  
vs  
SAMPLING FREQUENCY**

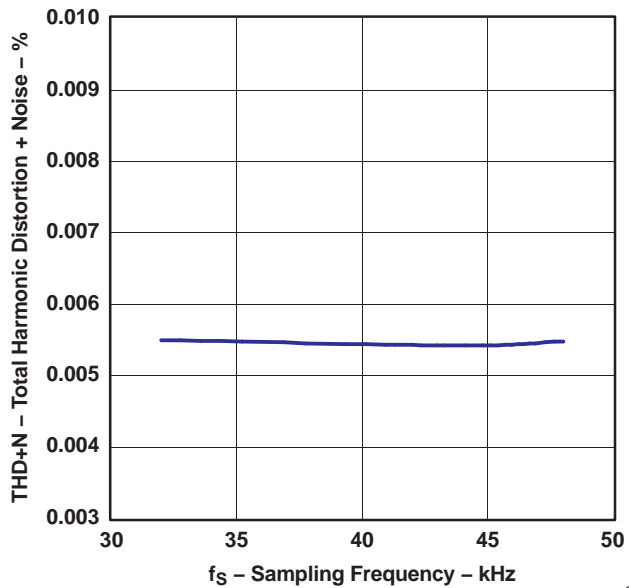

G005

Figure 5.

**DYNAMIC RANGE and SNR  
vs  
SAMPLING FREQUENCY**

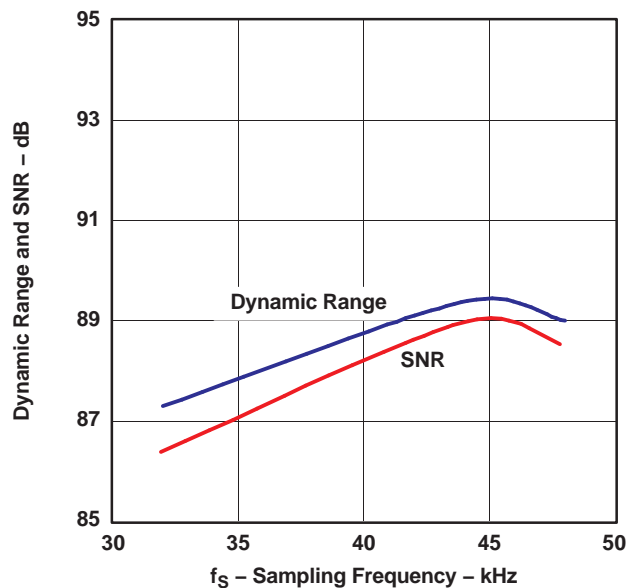

G006

Figure 6.

### TYPICAL CHARACTERISTICS (continued)

All specifications at  $T_A = 25^\circ\text{C}$ ,  $V_{DD} = V_{CC} = V_{CCP1} = V_{CCP2} = V_{CCx} = 3.3\text{ V}$ ,  $f_s = 44.1\text{ kHz}$ ,  $f_{IN} = 1\text{ kHz}$ , 16-bit data, unless otherwise noted.

#### DAC

TOTAL HARMONIC DISTORTION + NOISE at 0 dB  
vs  
FREE-AIR TEMPERATURE

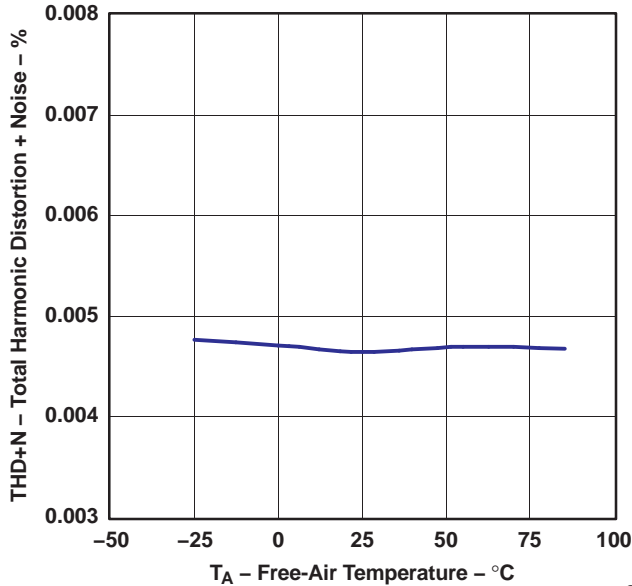

G007

Figure 7.

DYNAMIC RANGE and SNR  
vs  
FREE-AIR TEMPERATURE

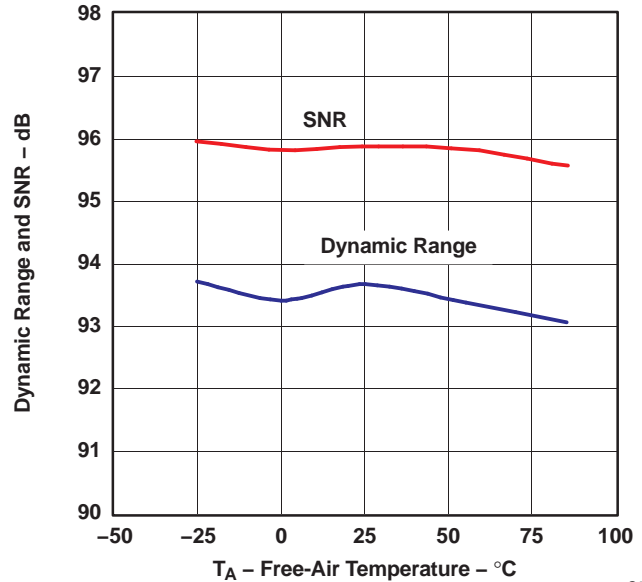

G008

Figure 8.

TOTAL HARMONIC DISTORTION + NOISE at 0 dB  
vs  
SUPPLY VOLTAGE

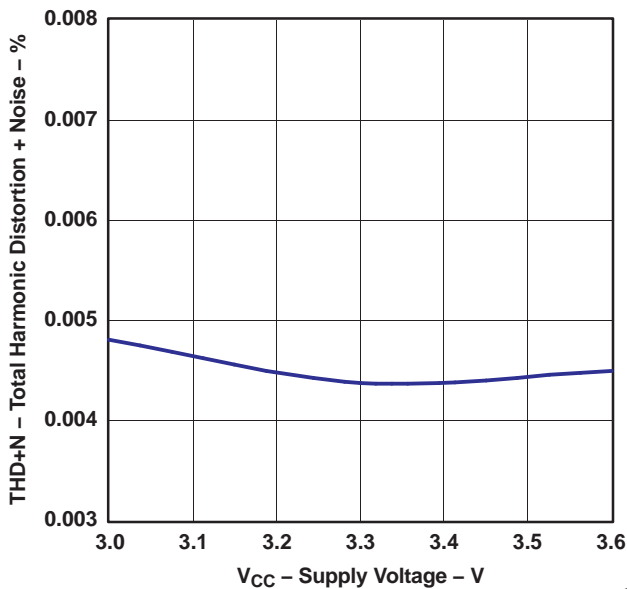

G009

Figure 9.

DYNAMIC RANGE and SNR  
vs  
SUPPLY VOLTAGE

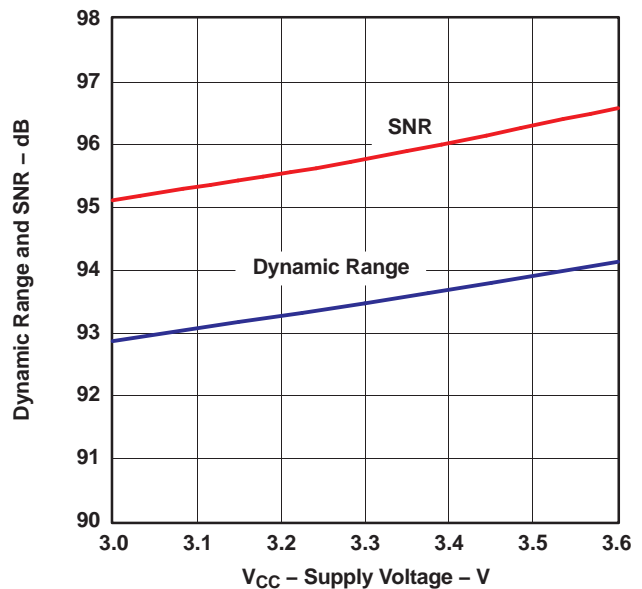

G010

Figure 10.

**TYPICAL CHARACTERISTICS (continued)**

All specifications at  $T_A = 25^\circ\text{C}$ ,  $V_{DD} = V_{CCC} = V_{CCP1} = V_{CCP2} = V_{CCx} = 3.3\text{ V}$ ,  $f_s = 44.1\text{ kHz}$ ,  $f_{IN} = 1\text{ kHz}$ , 16-bit data, unless otherwise noted.

**TOTAL HARMONIC DISTORTION + NOISE at 0 dB  
VS  
SAMPLING FREQUENCY**

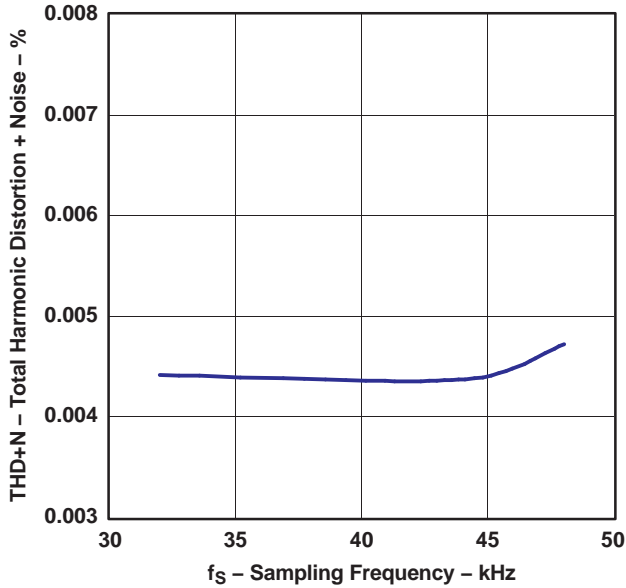

Figure 11.

G011

**DYNAMIC RANGE and SNR  
VS  
SAMPLING FREQUENCY**

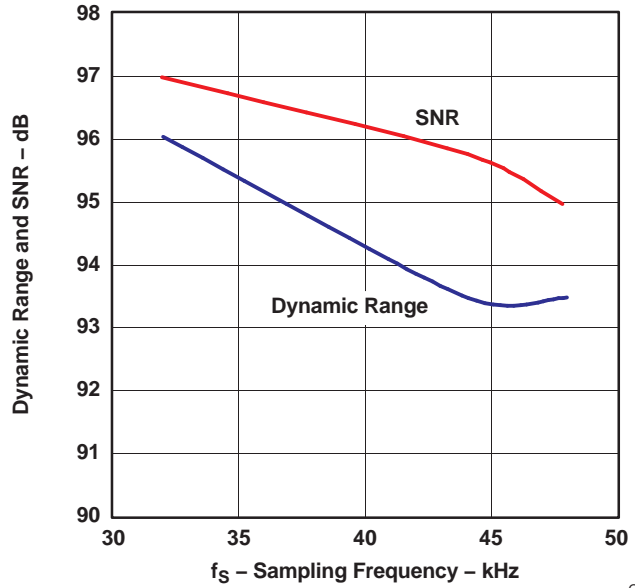

Figure 12.

G012

**ADC OUTPUT SPECTRUM**

**OUTPUT SPECTRUM (-0.5 dB, N = 8192)**

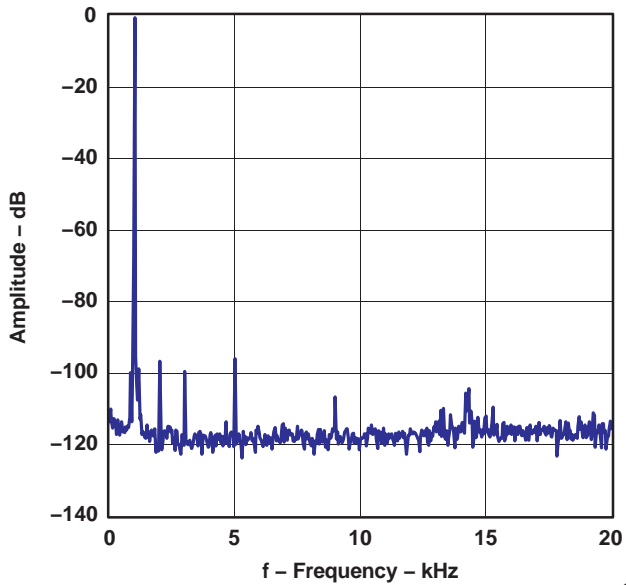

Figure 13.

G013

**OUTPUT SPECTRUM (-60 dB, N = 8192)**

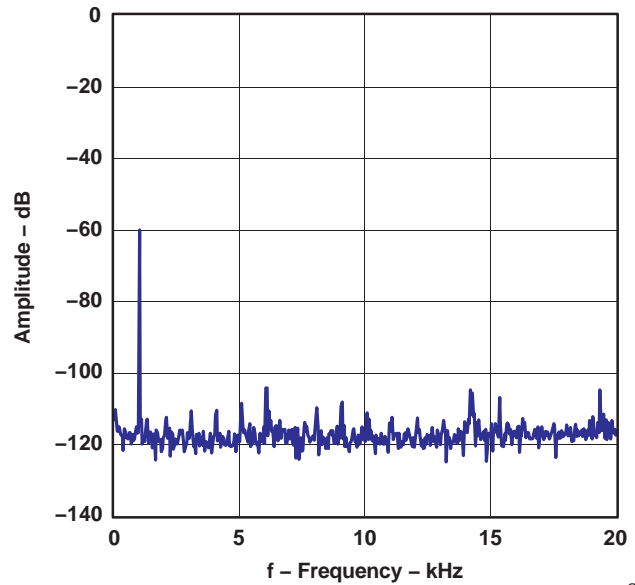

Figure 14.

G014

### TYPICAL CHARACTERISTICS (continued)

All specifications at  $T_A = 25^\circ\text{C}$ ,  $V_{DD} = V_{CCC} = V_{CCP1} = V_{CCP2} = V_{CCX} = 3.3\text{ V}$ ,  $f_s = 44.1\text{ kHz}$ ,  $f_{IN} = 1\text{ kHz}$ , 16-bit data, unless otherwise noted.

#### DAC OUTPUT SPECTRUM

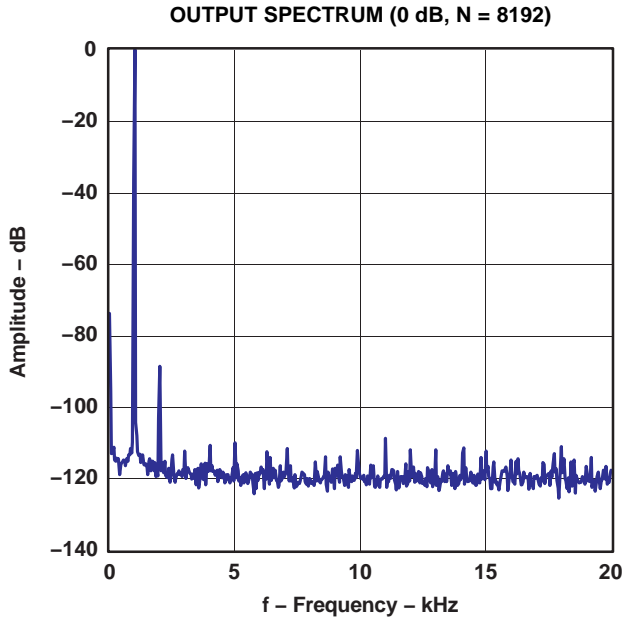

Figure 15.

G015

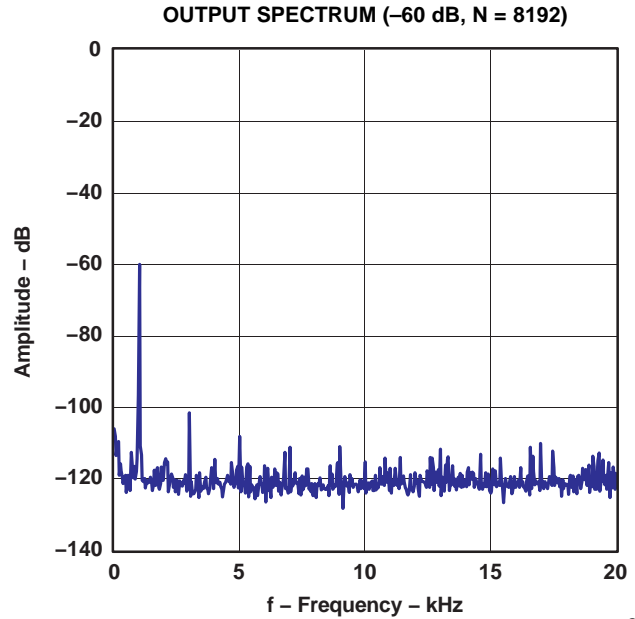

Figure 16.

G016

#### SUPPLY CURRENT

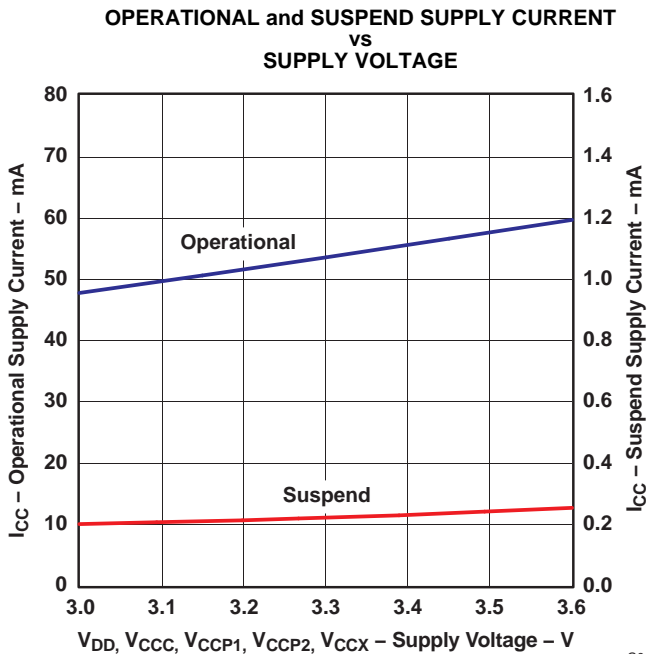

Figure 17.

G017

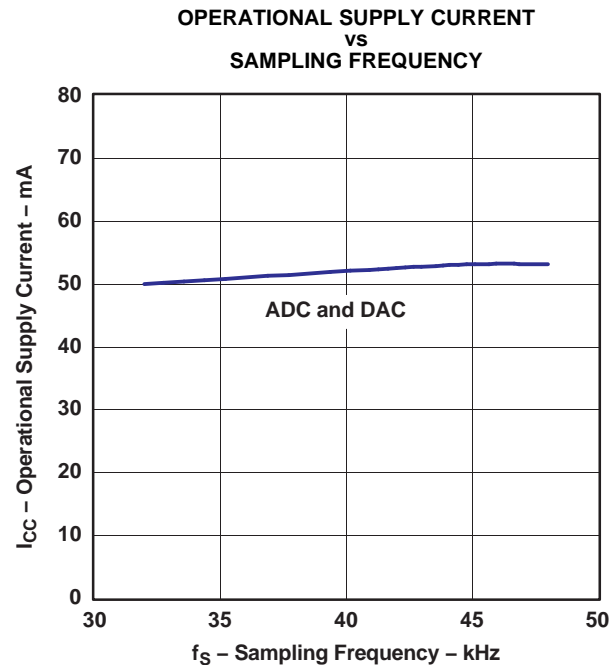

Figure 18.

G018

**TYPICAL CHARACTERISTICS (continued)**

All specifications at  $T_A = 25^\circ\text{C}$ ,  $V_{DD} = V_{CC} = V_{CCP1} = V_{CCP2} = V_{CCx} = 3.3\text{ V}$ ,  $f_s = 44.1\text{ kHz}$ ,  $f_{IN} = 1\text{ kHz}$ , 16-bit data, unless otherwise noted.

**ADC DIGITAL DECIMATION FILTER FREQUENCY RESPONSE**

**OVERALL CHARACTERISTICS**

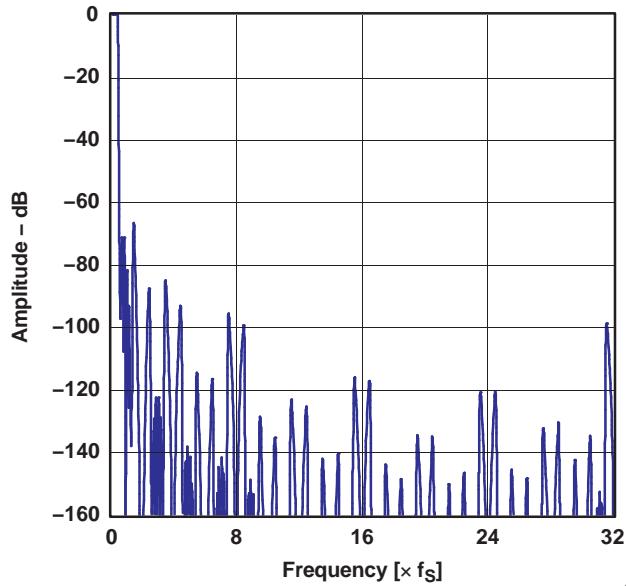

G019

Figure 19.

**STOP-BAND ATTENUATION**

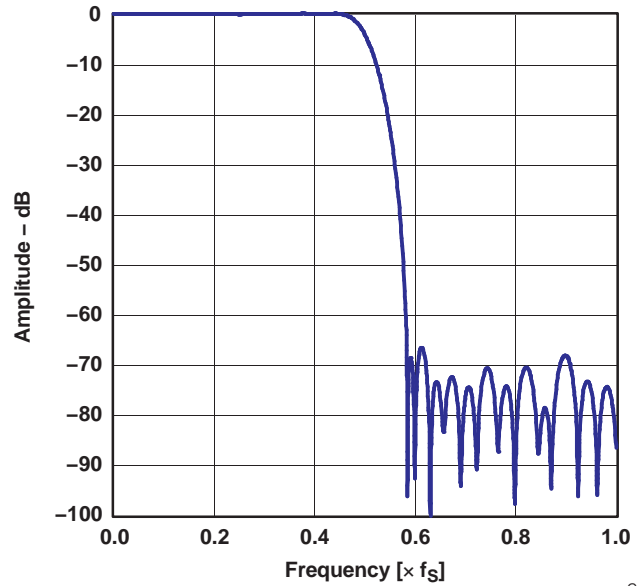

G020

Figure 20.

**PASS-BAND RIPPLE**

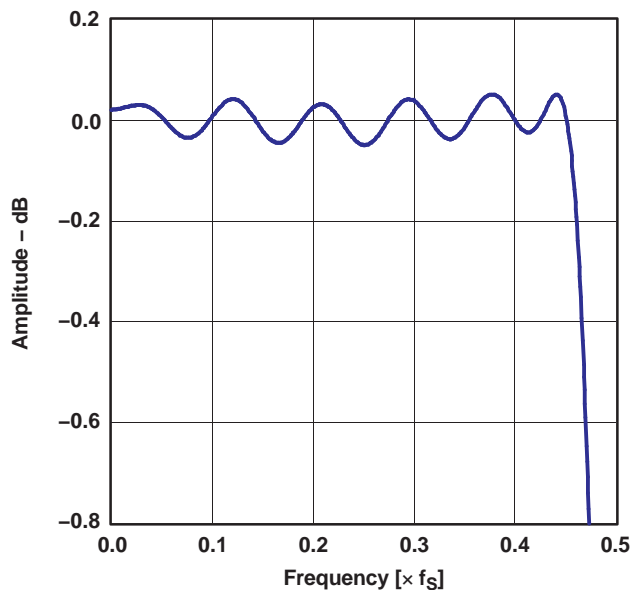

G021

Figure 21.

**TRANSITION-BAND RESPONSE**

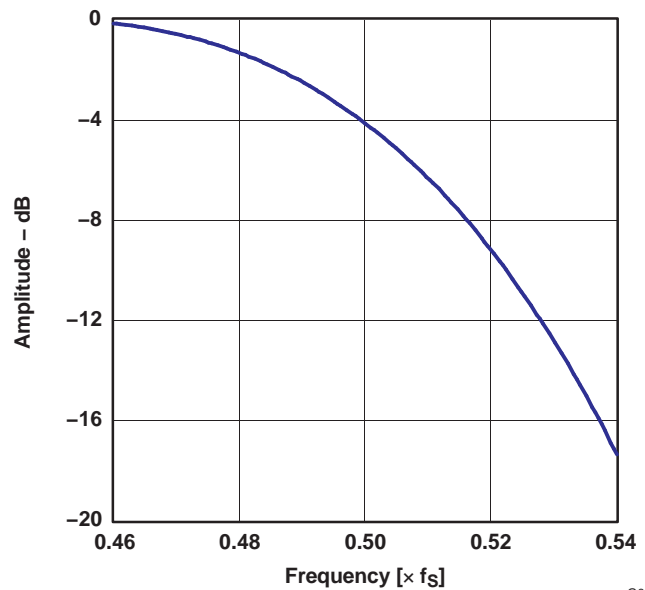

G022

Figure 22.



### TYPICAL CHARACTERISTICS (continued)

All specifications at  $T_A = 25^\circ\text{C}$ ,  $V_{DD} = V_{CC} = V_{CCP1} = V_{CCP2} = V_{CCX} = 3.3\text{ V}$ ,  $f_s = 44.1\text{ kHz}$ ,  $f_{IN} = 1\text{ kHz}$ , 16-bit data, unless otherwise noted.

#### ADC DIGITAL HIGH-PASS FILTER FREQUENCY RESPONSE

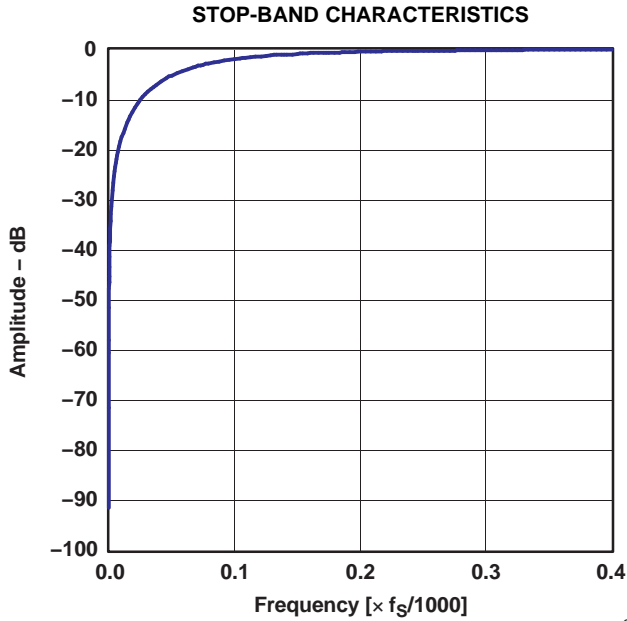

Figure 23.

G023

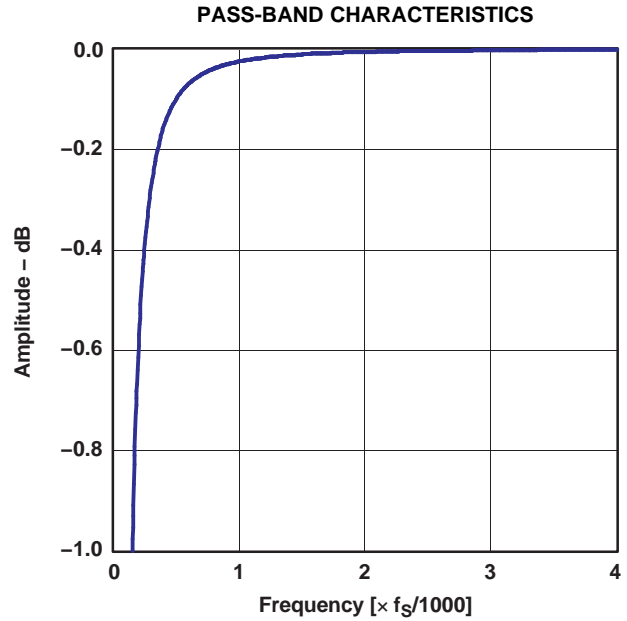

Figure 24.

G024

#### ADC ANALOG ANTIALIASING FILTER FREQUENCY RESPONSE

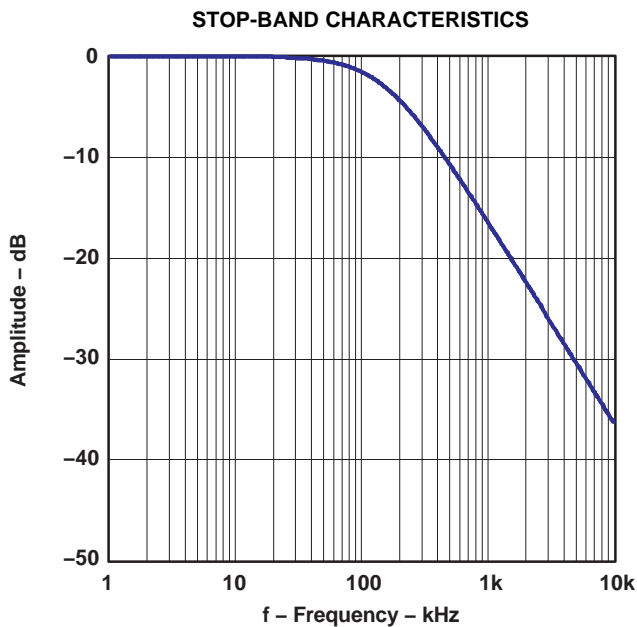

Figure 25.

G025

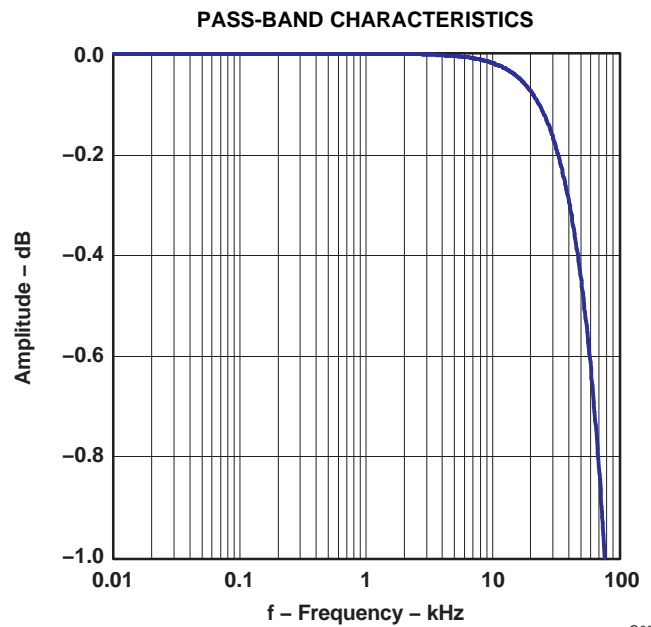

Figure 26.

G026

**TYPICAL CHARACTERISTICS (continued)**

All specifications at  $T_A = 25^\circ\text{C}$ ,  $V_{DD} = V_{CCC} = V_{CCP1} = V_{CCP2} = V_{CCX} = 3.3\text{ V}$ ,  $f_s = 44.1\text{ kHz}$ ,  $f_{IN} = 1\text{ kHz}$ , 16-bit data, unless otherwise noted.

**DAC DIGITAL INTERPOLATION FILTER FREQUENCY RESPONSE**

**STOP-BAND ATTENUATION**

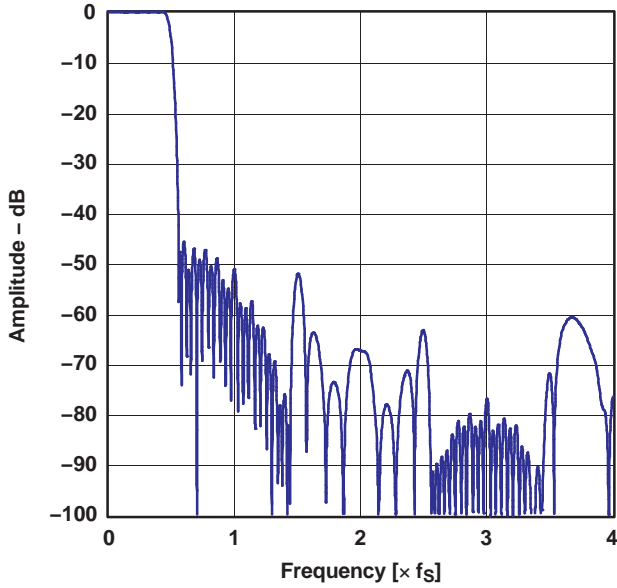

G027

Figure 27.

**PASS-BAND RIPPLE**

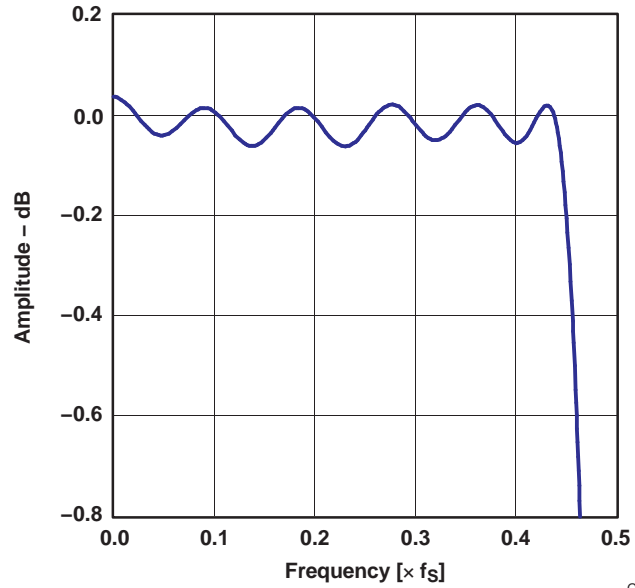

G028

Figure 28.

**TRANSITION-BAND RESPONSE**

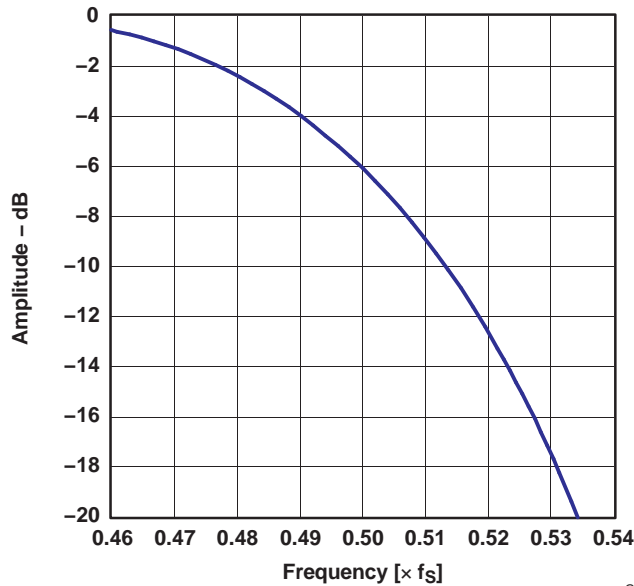

G029

Figure 29.

### TYPICAL CHARACTERISTICS (continued)

All specifications at  $T_A = 25^\circ\text{C}$ ,  $V_{DD} = V_{CCC} = V_{CCP1} = V_{CCP2} = V_{CCX} = 3.3\text{ V}$ ,  $f_s = 44.1\text{ kHz}$ ,  $f_{IN} = 1\text{ kHz}$ , 16-bit data, unless otherwise noted.

#### DAC ANALOG FIR FILTER FREQUENCY RESPONSE

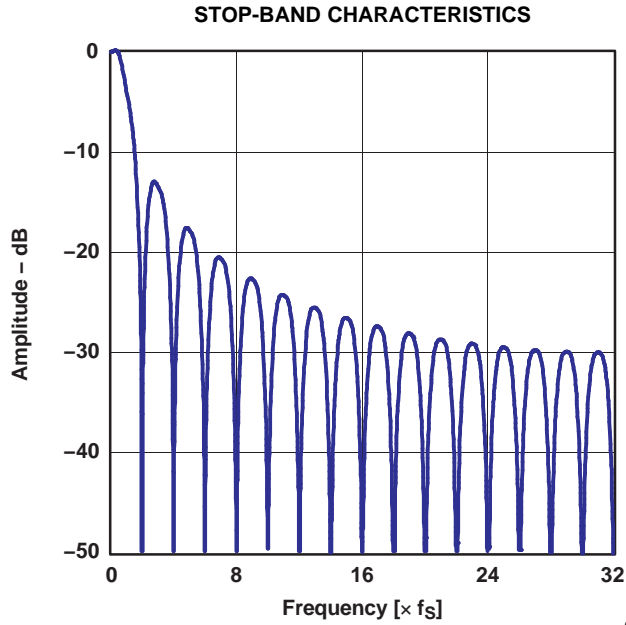

Figure 30.

G030

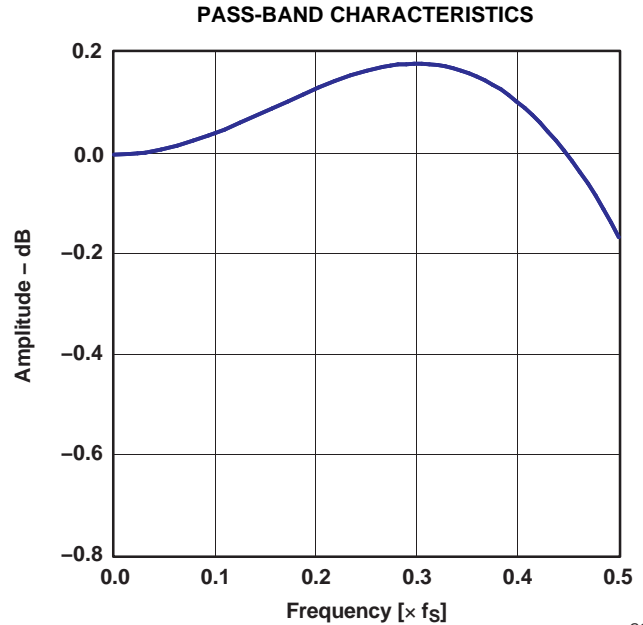

Figure 31.

G031

#### DAC ANALOG LOW-PASS FILTER FREQUENCY RESPONSE

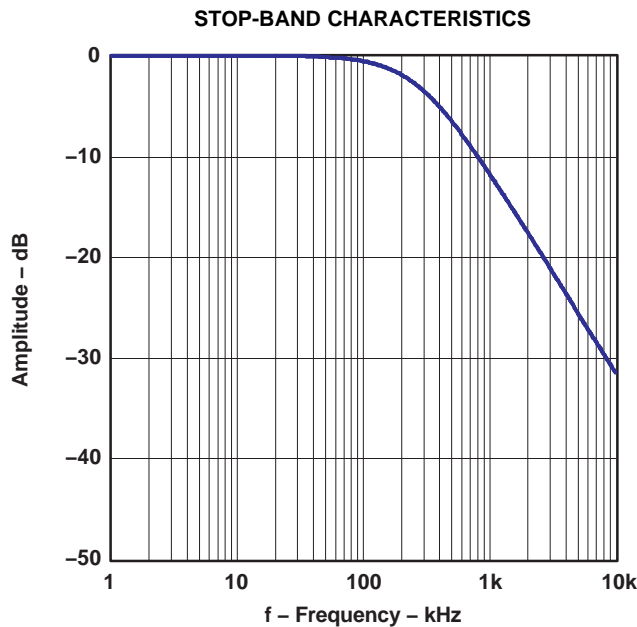

Figure 32.

G032

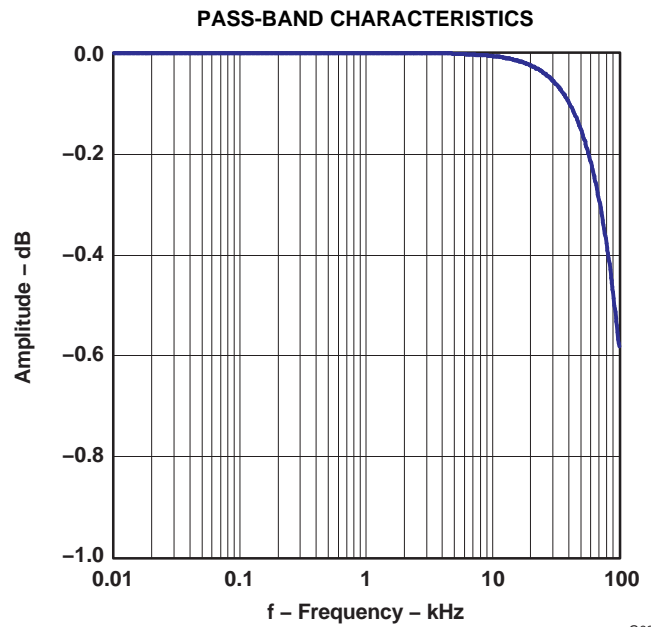

Figure 33.

G033

## DETAILED DESCRIPTION

### USB INTERFACE

Control data and audio data are transferred to the PCM2901/2903 via D+ (pin 1) and D– (pin 2). All data to/from the PCM2901/2903 is transferred at full speed. The device descriptor contains the information described in Table 1. The device descriptor can be modified on request; contact a Texas Instruments representative for details.

**Table 1. Device Descriptor**

USB revision	1.1 compliant
Device class	0x00 (device-defined interface level)
Device subclass	0x00 (not specified)
Device protocol	0x00 (not specified)
Max packet size for end-point 0	8 bytes
Vendor ID	0x08BB (default value, can be modified)
Product ID	0x2901 / 0x2903 (default value, can be modified)
Device release number	1.0 (0x0100)
Number of configurations	1
Vendor strings	String #1 (see <a href="#">Table 3</a> )
Product strings	String #2 (see <a href="#">Table 3</a> )
Serial number	Not supported

The configuration descriptor contains the information described in [Table 2](#). The configuration descriptor can be modified on request; contact a Texas Instruments representative for details.

**Table 2. Configuration Descriptor**

Interface	Four interfaces
Power attribute	0xC0 (Self-powered, no remote wakeup)
Maximum power	0x00 (0 mA. Default value, can be modified)

The string descriptor contains the information described in [Table 3](#). The string descriptor can be modified on request; contact a Texas Instruments representative for details.

**Table 3. String Descriptor**

#0	0x0409
#1	Burr-Brown from TI (default value, can be modified)
#2	USB audio codec (default value, can be modified)

## DEVICE CONFIGURATON

Figure 34 illustrates the USB audio function topology. The PCM2901/2903 has four interfaces. Each interface is constructed by alternative settings.

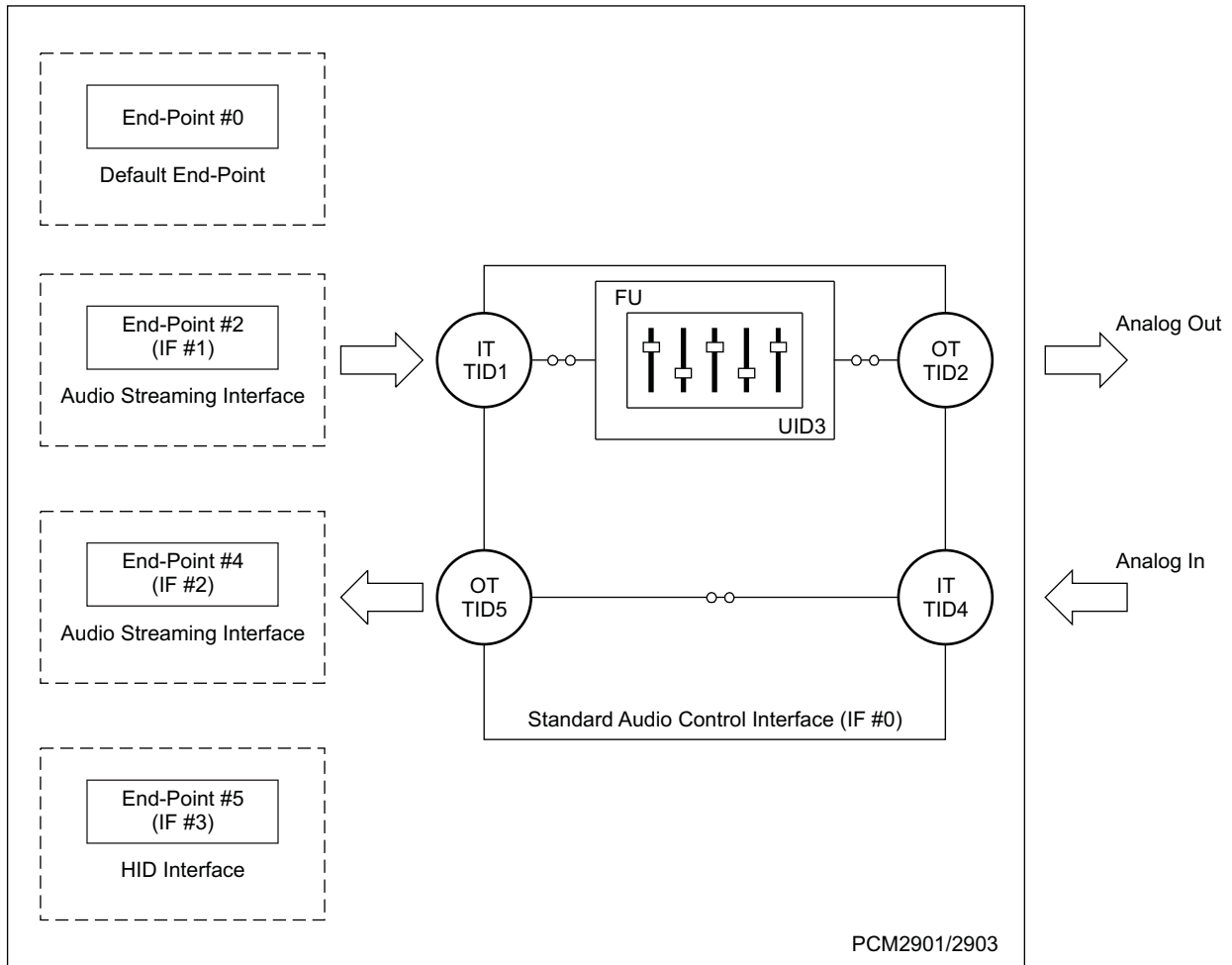

M0024-04

**Figure 34. USB Audio Function Topology**

## Interface #0

Interface #0 is defined as the control interface. Alternative setting #0 is the only possible setting for interface #0. Alternative setting #0 describes the standard audio control interface. A terminal constructs the audio control interface. The PCM2901/2903 has the following five terminals.

- Input terminal (IT #1) for isochronous-out stream
- Output terminal (OT #2) for audio analog output
- Feature unit (FU #3) for DAC digital attenuator
- Input terminal (IT #4) for audio analog input
- Output terminal (OT #5) for isochronous-in stream

Input terminal #1 is defined as USB stream (terminal type 0x0101). Input terminal #1 can accept 2-channel audio streams constructed by left and right channels. Output terminal #2 is defined as a speaker (terminal type 0x0301). Input terminal #4 is defined as microphone (terminal type 0x0201). Output terminal #5 is defined as a USB stream (terminal type 0x0101). Output terminal #5 can generate 2-channel audio streams constructed by left and right channels. Feature unit #3 supports the following sound control features.

- Volume control
- Mute control

The built-in digital volume controller can be manipulated by an audio class specific request from 0 dB to –64 dB in 1-dB steps. Changes are made by incrementing or decrementing by one step (1 dB) for every  $1/f_s$  time interval until the volume level has reached the requested value. Each channel can be set for different values. The master volume control is not supported. A request to the master volume is stalled and ignored. The built-in digital mute controller can be manipulated by audio class-specific request. A master mute control request is acceptable. A request to an individual channel is stalled and ignored.

## Interface #1

Interface #1 is defined as the audio streaming data-out interface. Interface #1 has the following seven alternative settings. Alternative setting #0 is the zero-bandwidth setting.

ALTERNATIVE SETTING	DATA FORMAT			TRANSFER MODE	SAMPLING RATE (kHz)
00	Zero bandwidth				
01	16 bit	Stereo	2s complement (PCM)	Adaptive	32, 44.1, 48
02	16 bit	Mono	2s complement (PCM)	Adaptive	32, 44.1, 48
03	8 bit	Stereo	2s complement (PCM)	Adaptive	32, 44.1, 48
04	8 bit	Mono	2s complement (PCM)	Adaptive	32, 44.1, 48
05	8 bit	Stereo	Offset binary (PCM8)	Adaptive	32, 44.1, 48
06	8 bit	Mono	Offset binary (PCM8)	Adaptive	32, 44.1, 48

## Interface #2

Interface #2 is defined as the audio streaming data-in interface. Interface #2 has the following 19 alternative settings. Alternative setting #0 is the zero-bandwidth setting. All other alternative settings are operational settings.

ALTERNATIVE SETTING	DATA FORMAT			TRANSFER MODE	SAMPLING RATE (kHz)
00	Zero bandwidth				
01	16 bit	Stereo	2s complement (PCM)	Asynchronous	48
02	16 bit	Mono	2s complement (PCM)	Asynchronous	48
03	16 bit	Stereo	2s complement (PCM)	Asynchronous	44.1
04	16 bit	Mono	2s complement (PCM)	Asynchronous	44.1
05	16 bit	Stereo	2s complement (PCM)	Asynchronous	32
06	16 bit	Mono	2s complement (PCM)	Asynchronous	32
07	16 bit	Stereo	2s complement (PCM)	Asynchronous	22.05
08	16 bit	Mono	2s complement (PCM)	Asynchronous	22.05
09	16 bit	Stereo	2s complement (PCM)	Asynchronous	16
0A	16 bit	Mono	2s complement (PCM)	Asynchronous	16
0B	8 bit	Stereo	2s complement (PCM)	Asynchronous	16
0C	8 bit	Mono	2s complement (PCM)	Asynchronous	16
0D	8 bit	Stereo	2s complement (PCM)	Asynchronous	8
0E	8 bit	Mono	2s complement (PCM)	Asynchronous	8
0F	16 bit	Stereo	2s complement (PCM)	Synchronous	11.025
10	16 bit	Mono	2s complement (PCM)	Synchronous	11.025
11	8 bit	Stereo	2s complement (PCM)	Synchronous	11.025
12	8 bit	Mono	2s complement (PCM)	Synchronous	11.025

## Interface #3

Interface #3 is defined as the interrupt data-in interface. Alternative setting #0 is the only possible setting for interface #3. Interface #3 constructs the HID consumer control device. Interface #3 reports the following three key statuses.

- Mute (0xE209)
- Volume up (0xE909)
- Volume down (0xEA09)

## End-Points

The PCM2901/2903 has the following four end-points.

- Control end-point (EP #0)
- Isochronous-out audio data stream end-point (EP #2)
- Isochronous-in audio data stream end-point (EP #4)
- HID end-point (EP #5)

The control end-point is a default end-point. The control end-point is used to control all functions of the PCM2901/2903 by the standard USB request and USB audio-class-specific request from the host. The isochronous-out audio data stream end-point is an audio sink end-point, which receives the PCM audio data. The isochronous-out audio data stream end-point accepts the adaptive transfer mode. The isochronous-in audio data stream end-point is an audio source end-point, which transmits the PCM audio data. The isochronous-in audio data stream end-point uses asynchronous transfer mode. The HID end-point is an interrupt-in end-point. HID end-point reports HID0, HID1, and HID2 pin status every 32 ms.

The human interface device (HID) pins are defined as consumer control devices. The HID function is designed as an independent end-point from both isochronous-in and -out end-points. This means that the device affected by the HID operation depends on the host software. Typically, the HID function affects the primary audio-out device.

## Clock and Reset

The PCM2901/2903 requires a 12-MHz ( $\pm 500$  ppm) clock for the USB and audio function, which can be generated by a built-in crystal oscillator with a 12-MHz crystal resonator or supplied by an external clock. The 12-MHz crystal resonator must be connected to XTI (pin 21) and XTO (pin 20) with one high (1-M $\Omega$ ) resistor and two small capacitors, the capacitance of which depends on the load capacitance of the crystal resonator. If the external clock is used, the clock must be supplied to XTI, and XTO must be open.

The PCM2901/2903 has an internal power-on reset circuit, which works automatically when  $V_{DD}$  (pin 27) exceeds 2.5 V typical (2.7 V to 2.2 V), and about 700  $\mu$ s is required until internal reset release.)

## Digital Audio Interface (PCM2903)

The PCM2903 employs both S/PDIF input and output. Isochronous-out data from the host is encoded to the S/PDIF output and the DAC analog output. Input data is selected as either S/PDIF or ADC analog input. When the device detects an S/PDIF input and successfully locks on the received data, the isochronous-in transfer data source is automatically selected from S/PDIF itself; otherwise, the data source is selected to ADC analog input.

## Supported Input Data (PCM2903)

The following data formats are accepted by the S/PDIF input and output. All other data formats are unable to use S/PDIF.

- 48-kHz 16-bit stereo
- 44.1-kHz 16-bit stereo
- 32-kHz 16-bit stereo

Mismatch between input data format and host command may cause unexpected results except in the following conditions.

- Record monaural format from stereo data input at the same data rate
- Record 8-bit format from 16-bit data input at the same data rate

A combination of the foregoing conditions is not accepted.

For playback, all possible data-rate source is converted to 16-bit stereo format at the same source data rate.

## Channel Status Information (PCM2903)

The channel status information is fixed as consumer application, PCM mode, copyright, and digital/digital converter. All other bits are fixed as 0s except for the sample frequency, which is set automatically according to the data received through the USB.

## Copyright Management (PCM2903)

Isochronous-in data is affected by the serial copy management system (SCMS). Where receiving digital audio data that is indicated as original data in the control bit, input digital audio data transfers to the host. If the data is indicated as first generation or higher, transferred data is selected to analog input.

Digital audio data output is always encoded as original with SCMS control.

The implementation of this feature is an option for the customer. Note that it is the user's responsibility whether they implement this feature in their product or not.

## INTERFACE SEQUENCE

### Power On, Attach, and Playback Sequence

The PCM2901/2903 is ready for setup when the reset sequence has finished and the USB bus is attached. In order to perform certain reset sequences defined in the USB specification,  $V_{DD}$ ,  $V_{CC}$ ,  $V_{CCP1}$ ,  $V_{CCP2}$ , and  $V_{CCX}$  must rise up with 10 ms / 3.3 V. After connection has been established by setup, the PCM2901/2903 is ready to accept USB audio data. While waiting, the audio data (idle state) and analog output are set to bipolar zero (BPZ).

When receiving the audio data, the PCM2901/2903 stores the first audio packet, which contained 1-ms audio data, into the internal storage buffer. The PCM2901/2903 starts playing the audio data when detecting the following start of frame (SOF) packet.



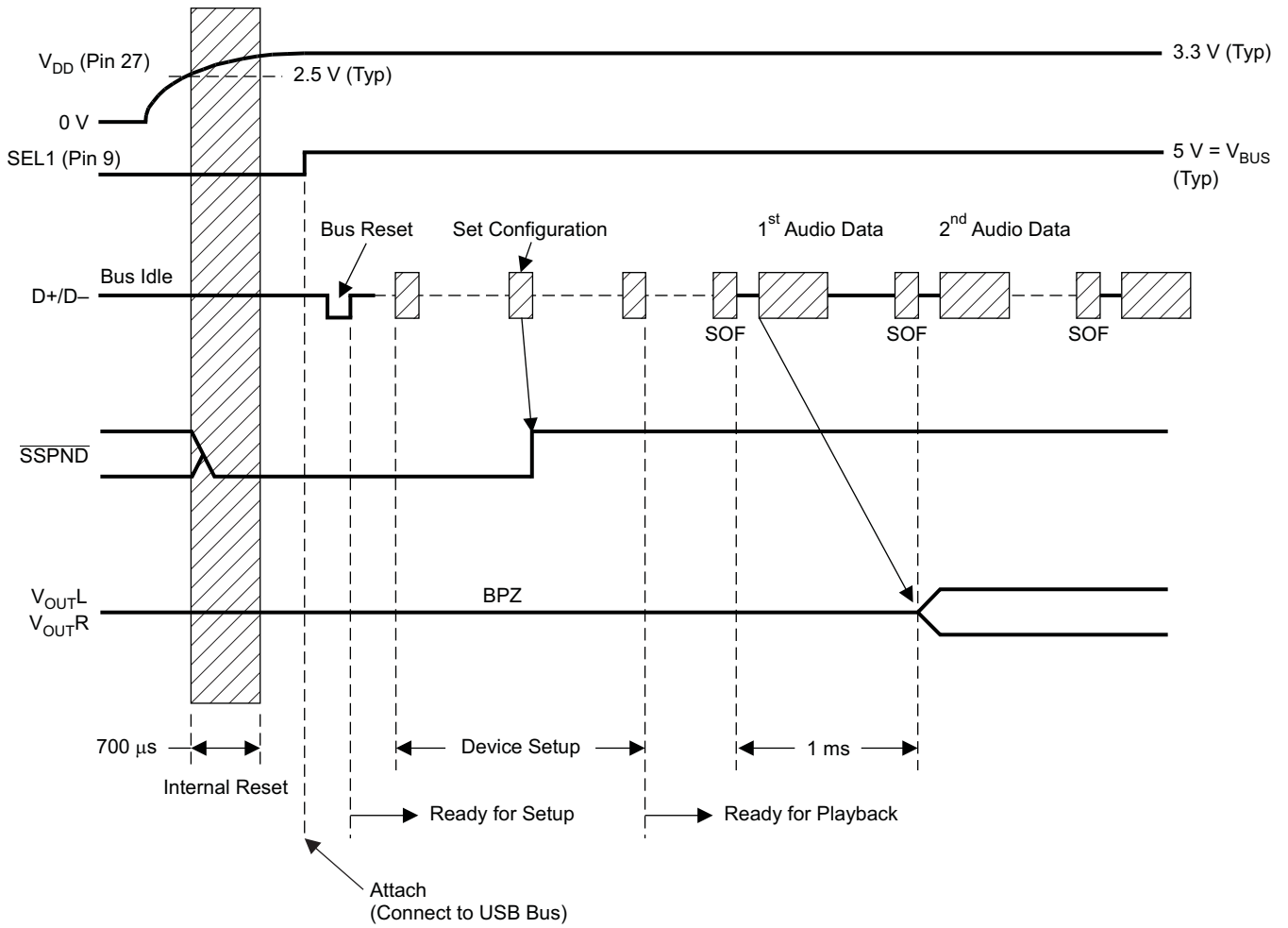

T0055-03

**Figure 35. Attach After Power On**

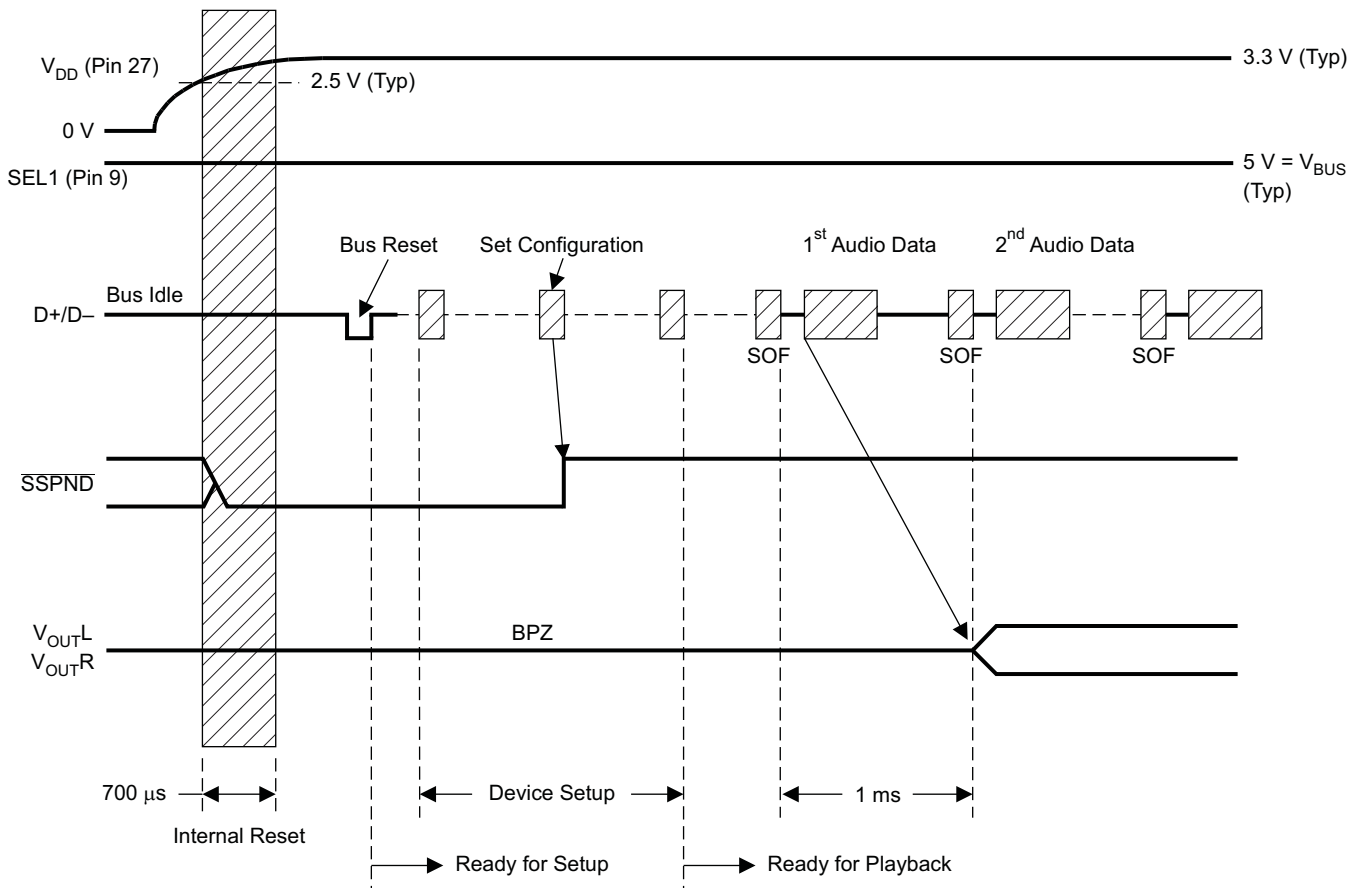

T0273-01

Figure 36. Power-On Under Attach

### Play, Stop, and Detach Sequence

When the host finishes or aborts the playback, the PCM2901/2903 stops playing after the last audio data has played.

### Record Sequence

The PCM2901/2903 starts the audio capture into the internal memory after receiving the SET\_INTERFACE command.

### Suspend and Resume Sequence

The PCM2901/2903 enters the suspend state after it detects a constant idle state on the USB bus, approximately 5 ms. While the PCM2901/2903 enters the suspend state, the SSPND flag (pin 28) is asserted. The PCM2901/2903 wakes up immediately after detecting a non-idle state on the USB bus.

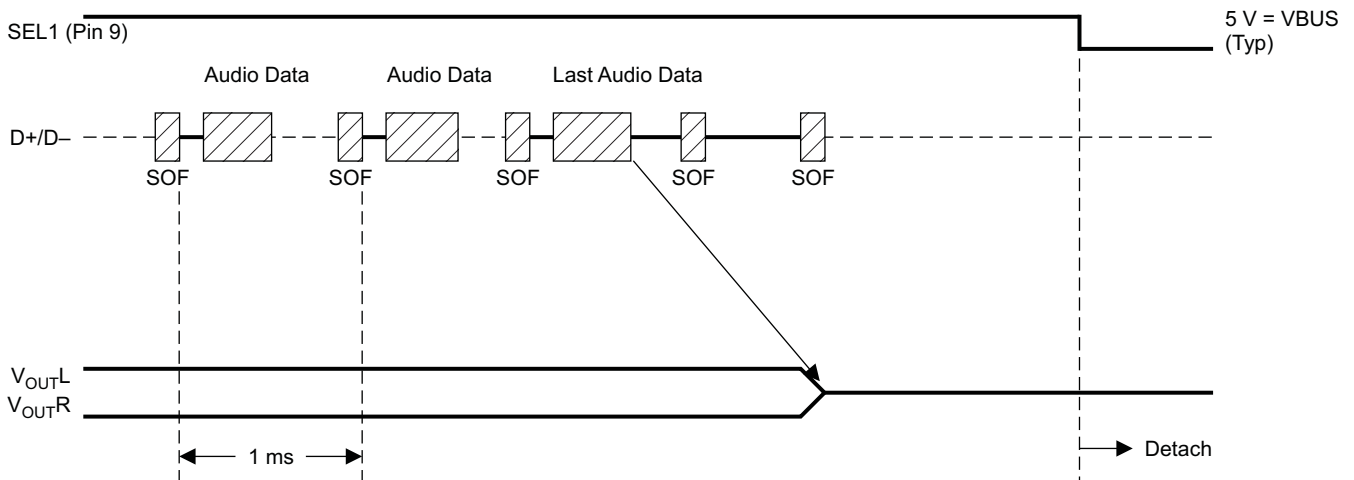

T0056-03

Figure 37. Play, Stop, and Detach

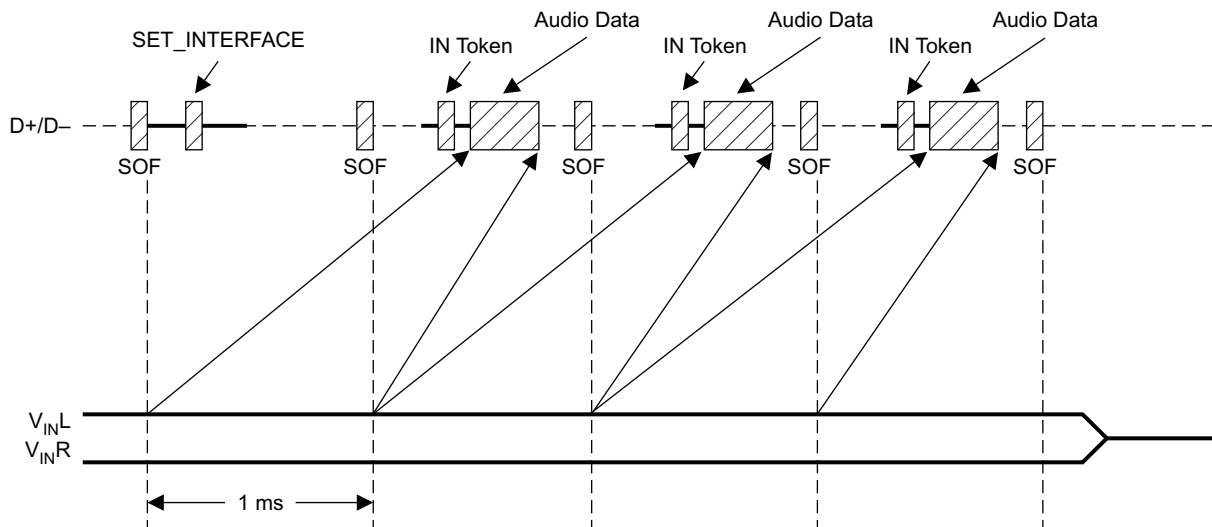

T0259-01

Figure 38. Record Sequence

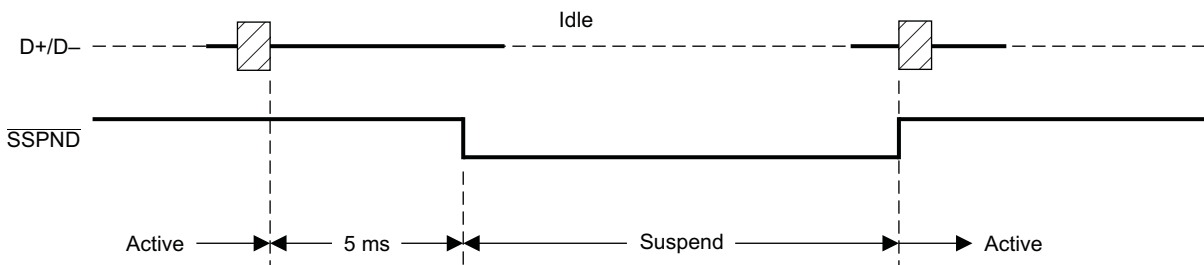

T0057-02

Figure 39. Suspend and Resume



## PCM2903 TYPICAL CIRCUIT CONNECTION

Figure 41 illustrates a typical circuit connection for a simple application. The circuit illustrated is for information only. The whole board design should be considered to meet the USB specification as a USB-compliant product.

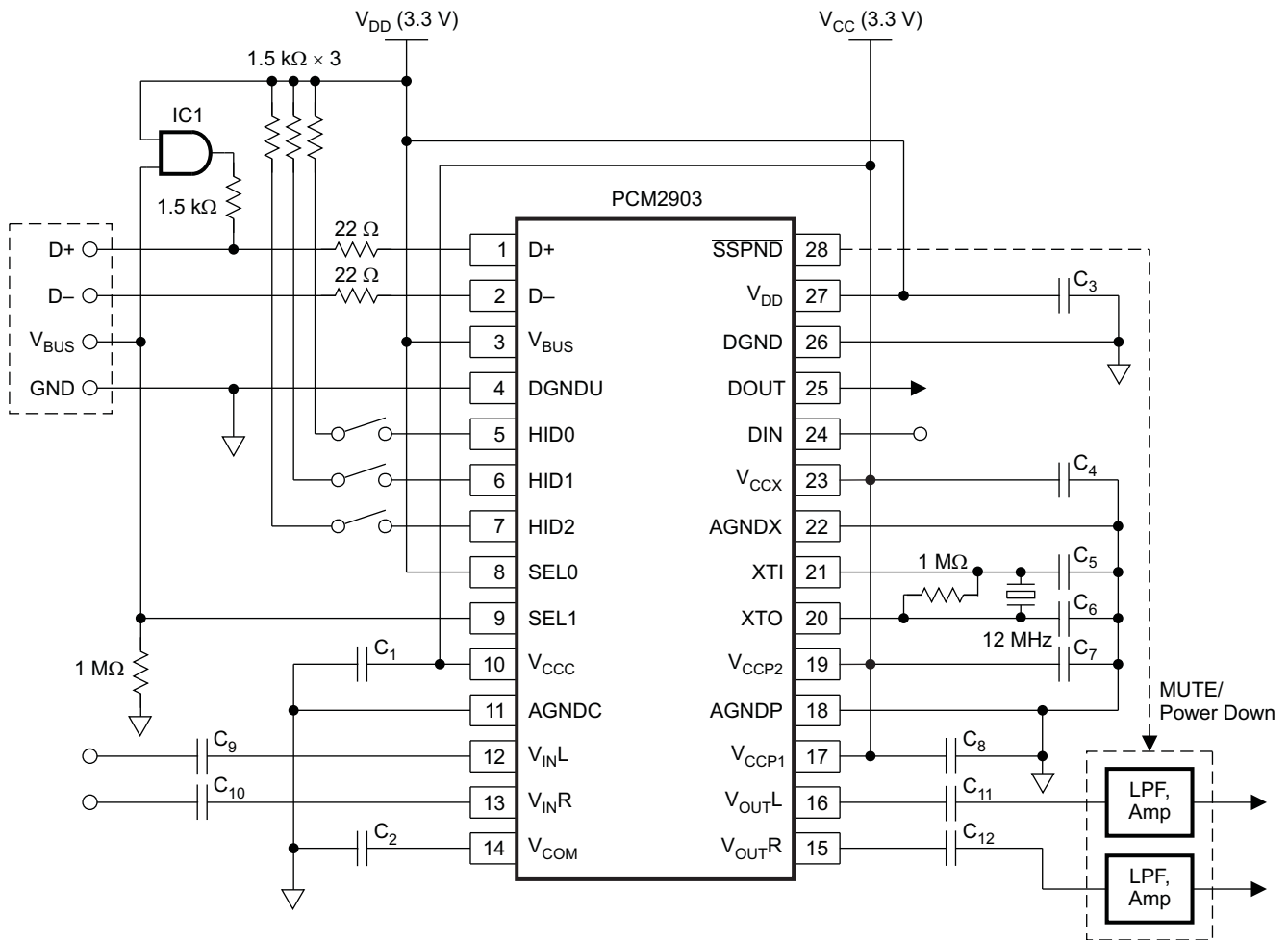

S0312-02

### NOTE:

- IC1 must be driven by V<sub>DD</sub> with a 5-V tolerant input.
- C<sub>1</sub>, C<sub>2</sub>, C<sub>3</sub>, C<sub>4</sub>, C<sub>7</sub>, C<sub>8</sub>: 10 μF
- C<sub>5</sub>, C<sub>6</sub>: 10 pF to 33 pF (depending on crystal resonator)
- C<sub>9</sub>, C<sub>10</sub>, C<sub>11</sub>, C<sub>12</sub>: The capacitance may vary depending on design.

Figure 41. Self-Powered Configuration

## APPENDIX

### Operating Environment

For current information on the PCM2901/2903 operating environment, see the *Updated Operating Environments for PCM270X, PCM290X Applications* application report, [SLAA374](#).

---

## REVISION HISTORY

Changes from Revision B (March 2002) to Revision C	Page
• Deleted operating environment information from data sheet and added reference to application report .....	30

---

**PACKAGING INFORMATION**

Orderable Device	Status (1)	Package Type	Package Drawing	Pins	Package Qty	Eco Plan (2)	Lead finish/ Ball material (6)	MSL Peak Temp (3)	Op Temp (°C)	Device Marking (4/5)	Samples
PCM2901E	ACTIVE	SSOP	DB	28	47	RoHS & Green	NIPDAU	Level-1-260C-UNLIM	0 to 70	PCM2901E	<a href="#">Samples</a>
PCM2901E/2K	ACTIVE	SSOP	DB	28	2000	RoHS & Green	NIPDAU	Level-1-260C-UNLIM	0 to 70	PCM2901E	<a href="#">Samples</a>
PCM2901EG4	ACTIVE	SSOP	DB	28	47	TBD	Call TI	Call TI	0 to 70		<a href="#">Samples</a>
PCM2903E	NRND	SSOP	DB	28	47	RoHS & Green	NIPDAU	Level-1-260C-UNLIM	0 to 70	PCM2903E	

(1) The marketing status values are defined as follows:

**ACTIVE:** Product device recommended for new designs.

**LIFEBUY:** TI has announced that the device will be discontinued, and a lifetime-buy period is in effect.

**NRND:** Not recommended for new designs. Device is in production to support existing customers, but TI does not recommend using this part in a new design.

**PREVIEW:** Device has been announced but is not in production. Samples may or may not be available.

**OBSOLETE:** TI has discontinued the production of the device.

(2) **RoHS:** TI defines "RoHS" to mean semiconductor products that are compliant with the current EU RoHS requirements for all 10 RoHS substances, including the requirement that RoHS substance do not exceed 0.1% by weight in homogeneous materials. Where designed to be soldered at high temperatures, "RoHS" products are suitable for use in specified lead-free processes. TI may reference these types of products as "Pb-Free".

**RoHS Exempt:** TI defines "RoHS Exempt" to mean products that contain lead but are compliant with EU RoHS pursuant to a specific EU RoHS exemption.

**Green:** TI defines "Green" to mean the content of Chlorine (Cl) and Bromine (Br) based flame retardants meet JS709B low halogen requirements of <=1000ppm threshold. Antimony trioxide based flame retardants must also meet the <=1000ppm threshold requirement.

(3) MSL, Peak Temp. - The Moisture Sensitivity Level rating according to the JEDEC industry standard classifications, and peak solder temperature.

(4) There may be additional marking, which relates to the logo, the lot trace code information, or the environmental category on the device.

(5) Multiple Device Markings will be inside parentheses. Only one Device Marking contained in parentheses and separated by a "~" will appear on a device. If a line is indented then it is a continuation of the previous line and the two combined represent the entire Device Marking for that device.

(6) Lead finish/Ball material - Orderable Devices may have multiple material finish options. Finish options are separated by a vertical ruled line. Lead finish/Ball material values may wrap to two lines if the finish value exceeds the maximum column width.

**Important Information and Disclaimer:**The information provided on this page represents TI's knowledge and belief as of the date that it is provided. TI bases its knowledge and belief on information provided by third parties, and makes no representation or warranty as to the accuracy of such information. Efforts are underway to better integrate information from third parties. TI has taken and continues to take reasonable steps to provide representative and accurate information but may not have conducted destructive testing or chemical analysis on incoming materials and chemicals. TI and TI suppliers consider certain information to be proprietary, and thus CAS numbers and other limited information may not be available for release.



In no event shall TI's liability arising out of such information exceed the total purchase price of the TI part(s) at issue in this document sold by TI to Customer on an annual basis.

**TAPE AND REEL INFORMATION**

**QUADRANT ASSIGNMENTS FOR PIN 1 ORIENTATION IN TAPE**

\*All dimensions are nominal

Device	Package Type	Package Drawing	Pins	SPQ	Reel Diameter (mm)	Reel Width W1 (mm)	A0 (mm)	B0 (mm)	K0 (mm)	P1 (mm)	W (mm)	Pin1 Quadrant
PCM2901E/2K	SSOP	DB	28	2000	330.0	17.4	8.5	10.8	2.4	12.0	16.0	Q1

**TAPE AND REEL BOX DIMENSIONS**

\*All dimensions are nominal

Device	Package Type	Package Drawing	Pins	SPQ	Length (mm)	Width (mm)	Height (mm)
PCM2901E/2K	SSOP	DB	28	2000	336.6	336.6	28.6

**TUBE**

\*All dimensions are nominal

Device	Package Name	Package Type	Pins	SPQ	L (mm)	W (mm)	T (μm)	B (mm)
PCM2901E	DB	SSOP	28	47	500	10.6	500	9.6
PCM2903E	DB	SSOP	28	47	500	10.6	500	9.6

# DB0028A



# PACKAGE OUTLINE

## SSOP - 2 mm max height

SMALL OUTLINE PACKAGE

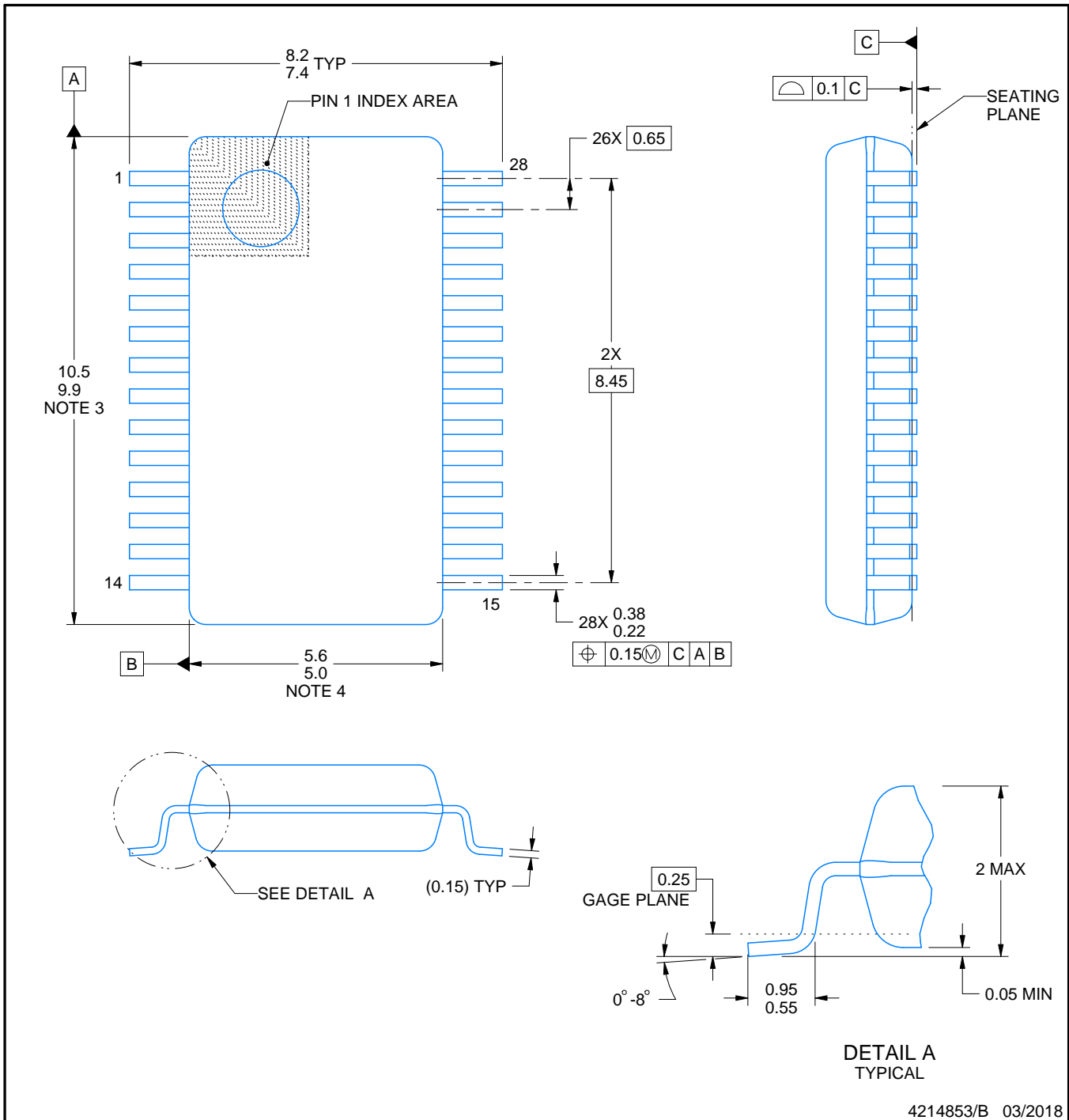

4214853/B 03/2018

### NOTES:

1. All linear dimensions are in millimeters. Any dimensions in parenthesis are for reference only. Dimensioning and tolerancing per ASME Y14.5M.
2. This drawing is subject to change without notice.
3. This dimension does not include mold flash, protrusions, or gate burrs. Mold flash, protrusions, or gate burrs shall not exceed 0.15 mm per side.
4. This dimension does not include interlead flash. Interlead flash shall not exceed 0.25 mm per side.
5. Reference JEDEC registration MO-150.

# EXAMPLE BOARD LAYOUT

DB0028A

SSOP - 2 mm max height

SMALL OUTLINE PACKAGE

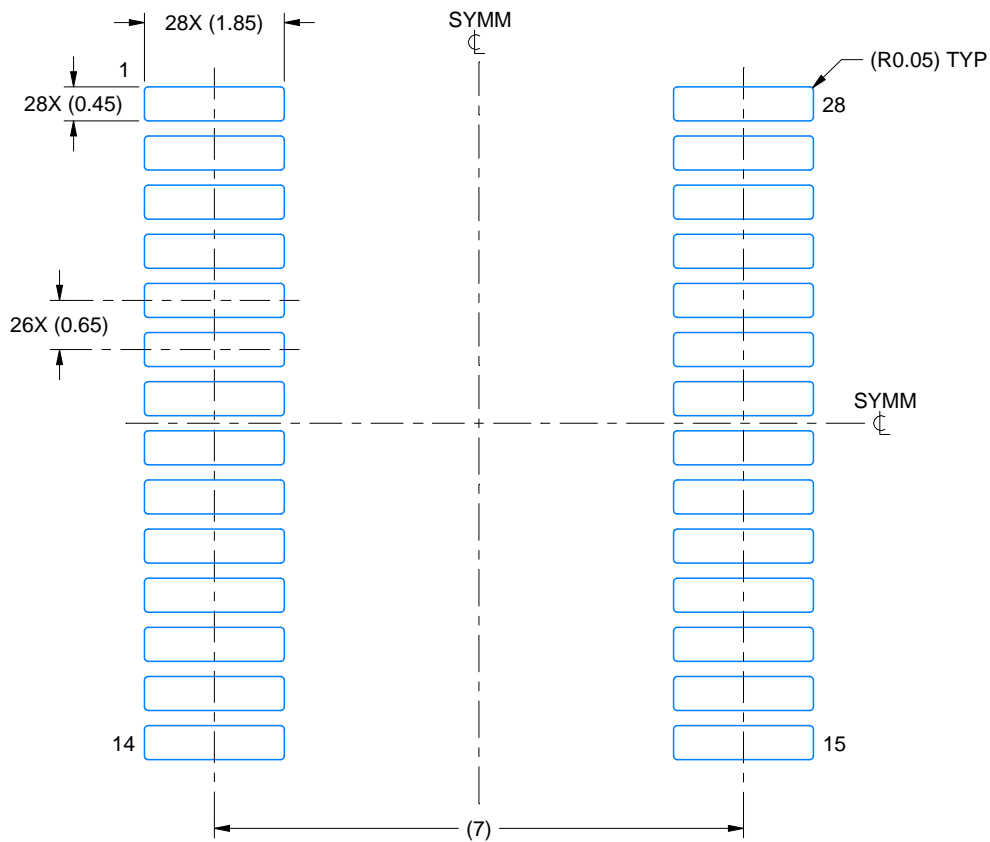

LAND PATTERN EXAMPLE  
EXPOSED METAL SHOWN  
SCALE: 10X

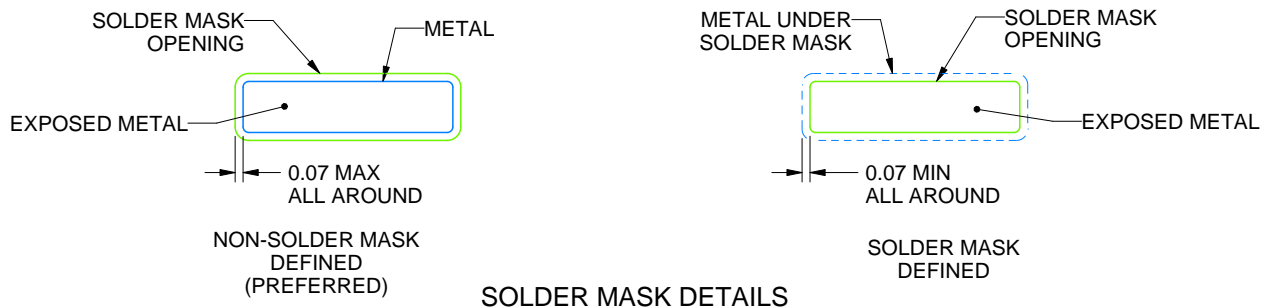

4214853/B 03/2018

NOTES: (continued)

- 6. Publication IPC-7351 may have alternate designs.
- 7. Solder mask tolerances between and around signal pads can vary based on board fabrication site.

# EXAMPLE STENCIL DESIGN

DB0028A

SSOP - 2 mm max height

SMALL OUTLINE PACKAGE



NOTES: (continued)

8. Laser cutting apertures with trapezoidal walls and rounded corners may offer better paste release. IPC-7525 may have alternate design recommendations.
9. Board assembly site may have different recommendations for stencil design.

## IMPORTANT NOTICE AND DISCLAIMER

TI PROVIDES TECHNICAL AND RELIABILITY DATA (INCLUDING DATA SHEETS), DESIGN RESOURCES (INCLUDING REFERENCE DESIGNS), APPLICATION OR OTHER DESIGN ADVICE, WEB TOOLS, SAFETY INFORMATION, AND OTHER RESOURCES "AS IS" AND WITH ALL FAULTS, AND DISCLAIMS ALL WARRANTIES, EXPRESS AND IMPLIED, INCLUDING WITHOUT LIMITATION ANY IMPLIED WARRANTIES OF MERCHANTABILITY, FITNESS FOR A PARTICULAR PURPOSE OR NON-INFRINGEMENT OF THIRD PARTY INTELLECTUAL PROPERTY RIGHTS.

These resources are intended for skilled developers designing with TI products. You are solely responsible for (1) selecting the appropriate TI products for your application, (2) designing, validating and testing your application, and (3) ensuring your application meets applicable standards, and any other safety, security, regulatory or other requirements.

These resources are subject to change without notice. TI grants you permission to use these resources only for development of an application that uses the TI products described in the resource. Other reproduction and display of these resources is prohibited. No license is granted to any other TI intellectual property right or to any third party intellectual property right. TI disclaims responsibility for, and you will fully indemnify TI and its representatives against, any claims, damages, costs, losses, and liabilities arising out of your use of these resources.

TI's products are provided subject to [TI's Terms of Sale](#) or other applicable terms available either on [ti.com](http://ti.com) or provided in conjunction with such TI products. TI's provision of these resources does not expand or otherwise alter TI's applicable warranties or warranty disclaimers for TI products.

TI objects to and rejects any additional or different terms you may have proposed.

Mailing Address: Texas Instruments, Post Office Box 655303, Dallas, Texas 75265  
Copyright © 2022, Texas Instruments Incorporated