

***Family of Curves
Demonstrating Output Skews for
Advanced BiCMOS Devices***

SCBA006A
December 1996



IMPORTANT NOTICE

Texas Instruments (TI) reserves the right to make changes to its products or to discontinue any semiconductor product or service without notice, and advises its customers to obtain the latest version of relevant information to verify, before placing orders, that the information being relied on is current.

TI warrants performance of its semiconductor products and related software to the specifications applicable at the time of sale in accordance with TI's standard warranty. Testing and other quality control techniques are utilized to the extent TI deems necessary to support this warranty. Specific testing of all parameters of each device is not necessarily performed, except those mandated by government requirements.

Certain applications using semiconductor products may involve potential risks of death, personal injury, or severe property or environmental damage ("Critical Applications").

TI SEMICONDUCTOR PRODUCTS ARE NOT DESIGNED, INTENDED, AUTHORIZED, OR WARRANTED TO BE SUITABLE FOR USE IN LIFE-SUPPORT APPLICATIONS, DEVICES OR SYSTEMS OR OTHER CRITICAL APPLICATIONS.

Inclusion of TI products in such applications is understood to be fully at the risk of the customer. Use of TI products in such applications requires the written approval of an appropriate TI officer. Questions concerning potential risk applications should be directed to TI through a local SC sales office.

In order to minimize risks associated with the customer's applications, adequate design and operating safeguards should be provided by the customer to minimize inherent or procedural hazards.

TI assumes no liability for applications assistance, customer product design, software performance, or infringement of patents or services described herein. Nor does TI warrant or represent that any license, either express or implied, is granted under any patent right, copyright, mask work right, or other intellectual property right of TI covering or relating to any combination, machine, or process in which such semiconductor products or services might be or are used.

Contents

	<i>Title</i>	<i>Page</i>
Introduction		1
Skews		1
Source of Data		1
Sources of Error in Data		2
Summary		2

List of Illustrations

<i>Figure</i>	<i>Title</i>	<i>Page</i>
1	Skew = $ t_{PLH14} - t_{PLH3} $	2
2	'ABT16240 – Single Switching	3
3	'ABT16240 – Simultaneous Switching	4
4	'ABT16245 – Single Switching	5
5	'ABT16952 – Single Switching	6
6	'ABT16500A – Single Switching	7
7	'ABT16500A – Simultaneous Switching	8
8	'ABT244 – Single Switching	9
9	'ABT244 – Multiple-Output Switching	10

Introduction

The data in this application report demonstrates the skew between the outputs of a sample of Texas Instruments Advanced BiCMOS (ABT) devices. This report explains which output skew is being examined, where the data comes from, and how the data is analyzed. Some of the errors that may be present in the data are discussed.

Skews

Skew is a term that defines the difference in time between two signal edges. Several different types of skew being used are defined in JEDEC 99 clause 2.3.5.

Output Skew [$t_{sk(o)}$] – The difference between two concurrent propagation delay times that originate at either a single input or two inputs switching simultaneously and terminating at different outputs.

Input Skew [$t_{sk(i)}$] – The difference between two propagation delay times that originate at different inputs and terminate at a single output.

Pulse Skew [$t_{sk(p)}$] – The difference between the propagation delay times t_{PLH} and t_{PHL} when a single switching input causes one or more outputs to switch.

Process Skew [$t_{sk(pr)}$] – The difference between identically specified propagation delay times on any two samples of an IC at identical operating conditions.

Limit Skew [$t_{sk(l)}$] – The difference between: 1) The greater of the maximum specified values of t_{PLH} and t_{PHL} and 2) The lesser of the minimum specified values of t_{PLH} and t_{PHL} .

The skew discussed here is the skew of propagation delays across the outputs of a device. More specifically, it is the difference between the largest value obtained for a propagation delay and the smallest value across all of the outputs. For example, if output 3 has the largest propagation delay t_{PLH} and output 14 has the smallest, the output skew for this device would be the difference between the propagation delays for output 3 and output 14 (see Figure 1).

The majority of the curves presented in this paper consist of data taken on devices that have one output switching at a time. This produces a skew that should not be confused with the defined data-sheet skew $t_{sk(o)}$. The data-sheet value for $t_{sk(o)}$ is found by switching all of the outputs simultaneously. Two of the devices examined in this paper ('ABT16240 and 'ABT16500A) include curves that present $t_{sk(o)}$ data.

Source of Data

The data used to produce the curves presented in this paper was extracted from the characterization data bases used to prepare the data sheets for the devices presented. The sample size of the data base is approximately 30 devices for each characterization lot (wafer) used.

The data was sorted so that the maximum skew for each device at a particular V_{CC} and temperature combination could be determined. Next, the maximum skew values were averaged to produce a data point for each transition. Further statistical analysis of this data was performed to calculate a standard deviation of the maximum skew across the devices. This value was then used to produce a three-standard-deviation data point for each V_{CC} and temperature combination. The data is presented as a family of curves across V_{CC} , with each member of the family being an output skew versus temperature curve. The curves for each device are broken out by output transition (i.e., t_{PLH} , t_{PHL}). Each transition is further separated into a set of curves depicting the average skew across the devices and a set representing the average skew, plus three standard deviations.

For those devices ('ABT16952 and 'ABT16500A) that have registers, the data path chosen for each device was the path that put the device in a transparent mode. Also, for the bidirectional devices ('ABT16245, 'ABT16952, and 'ABT16500A), the A-to-B direction was used.

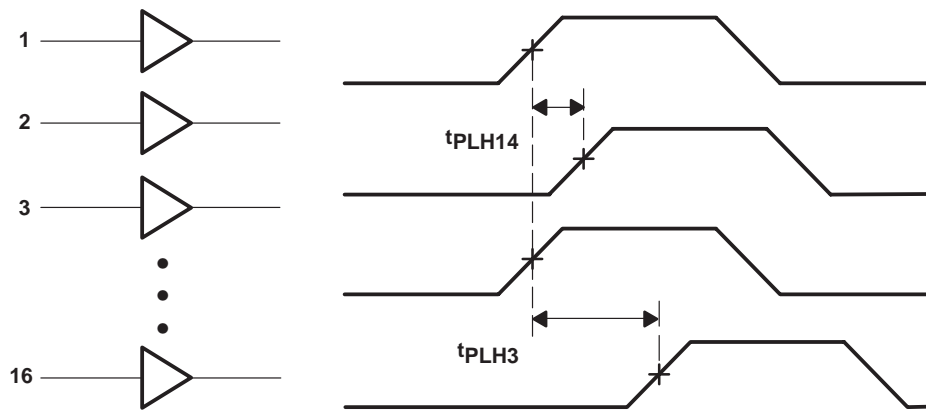

Figure 1. Skew = $|t_{PLH14} - t_{PLH3}|$

Sources of Error in Data

The data in this report was taken on an IMPACT tester, which is automatic test equipment used to characterize integrated circuits. The tester is offset using a golden unit that has had data taken on a laboratory bench setup. The offsetting process is the main source of error in the data.

Briefly, the tester is offset in the following manner. The golden unit has its propagation delay measurements taken at 25°C and 85°C using a pulse generator as the source and an oscilloscope as the measurement device. The golden unit is then placed on the IMPACT and the data is again taken. The difference between the two values is the offset. The 25°C offsets are used for the data taken at -55°C, -40°C, and 25°C, while the 85°C offsets are used at 85°C and 125°C.

Great care is taken during this process to ensure that the induced error is kept to a minimum. For example, the boards are checked before use to ensure the output loads are correct, the oscilloscope is calibrated each day, and the input signals are closely monitored to ensure that the intended signal is delivered to the golden unit.

This reduction in error is quite important in this application because the average skews for the devices are about 200 ps. A 20-ps error in offsets translates into an approximate error of 10% in the output skew data. However, it can be seen in the curves presented here that the error has been kept to a minimum and that the curves are fairly well behaved.

Summary

The family of curves presented in Figures 2 through 9 demonstrates that the Texas Instruments Advanced BiCMOS family of devices can be expected to produce an average skew between outputs that remain below 400 ps for devices with single switching outputs. Also, when a device's outputs switch simultaneously, the average skew across the outputs can be expected to remain below 700 ps.

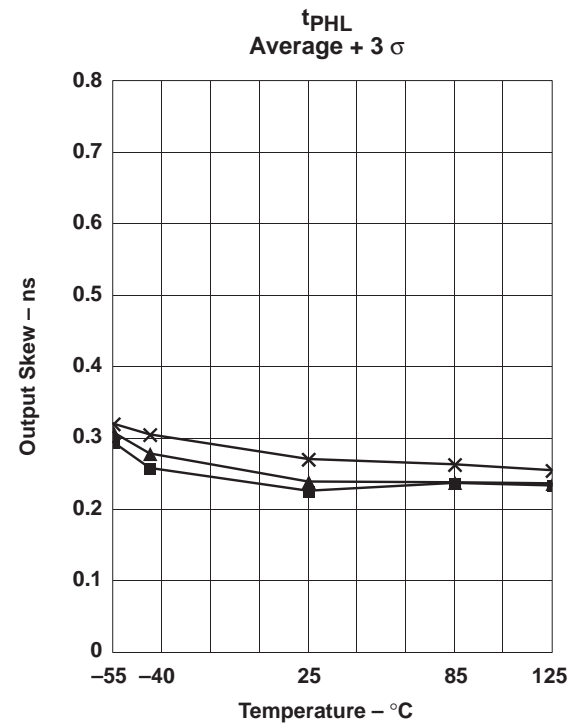
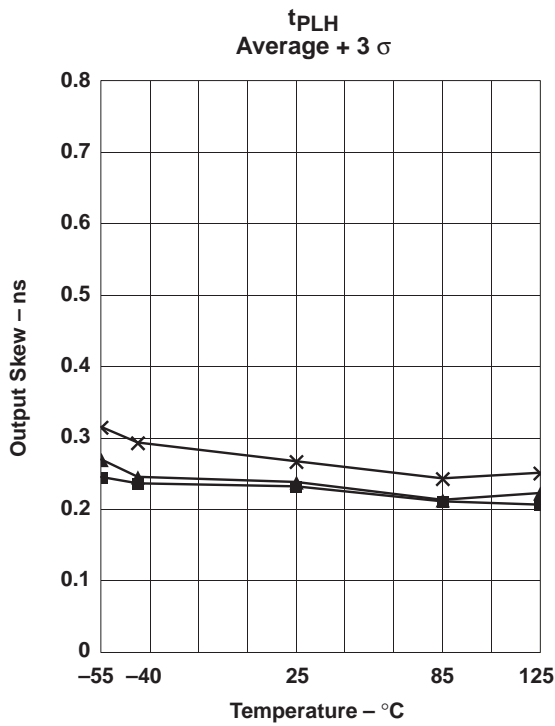
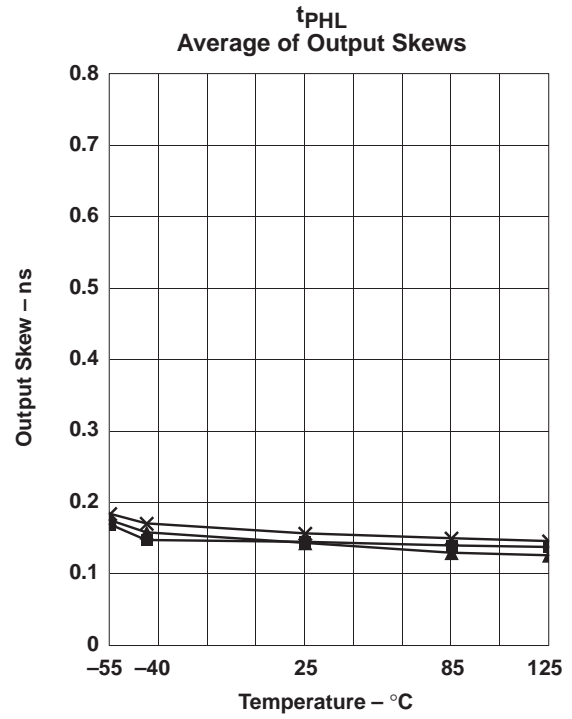
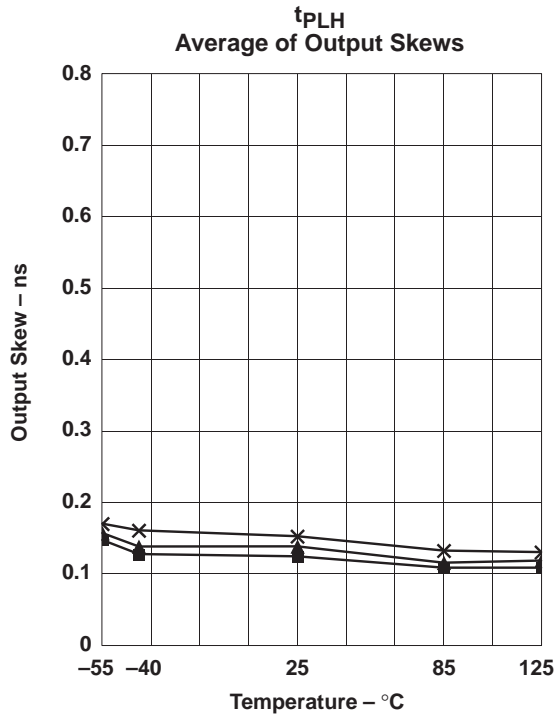

X - V_{CC} = 4.5 V
 Y - V_{CC} = 5 V
 ± V_{CC} = 5.5 V

Figure 2. 'ABT16240 – Single Switching

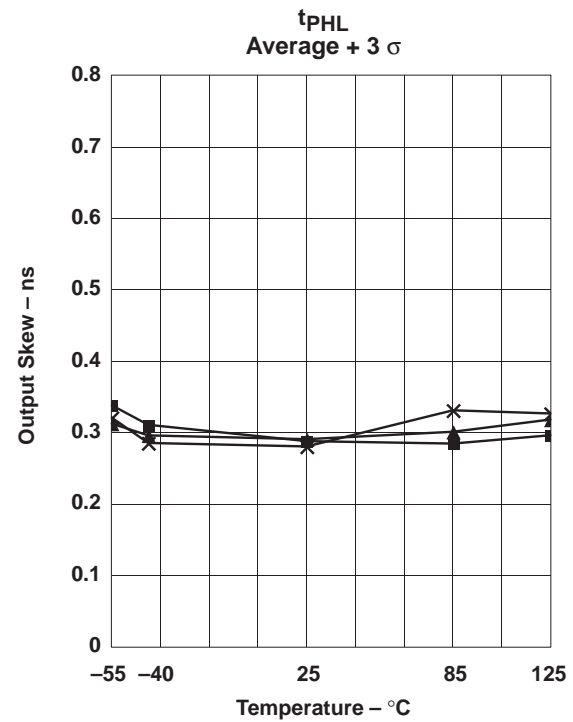
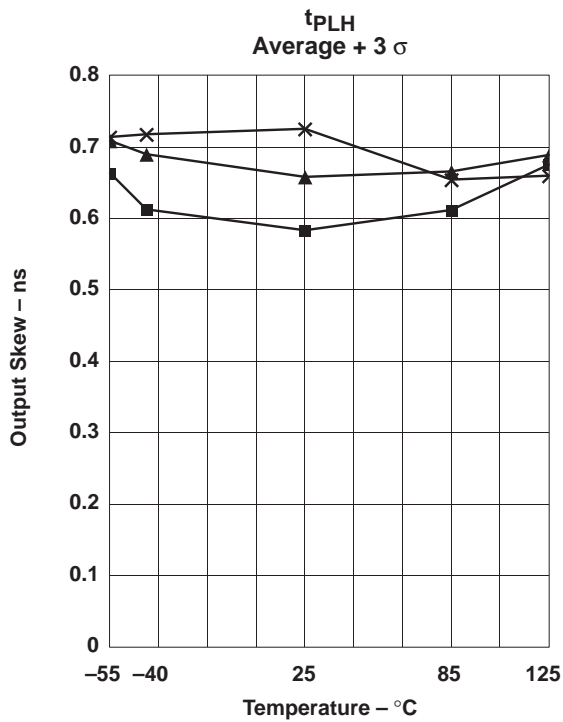
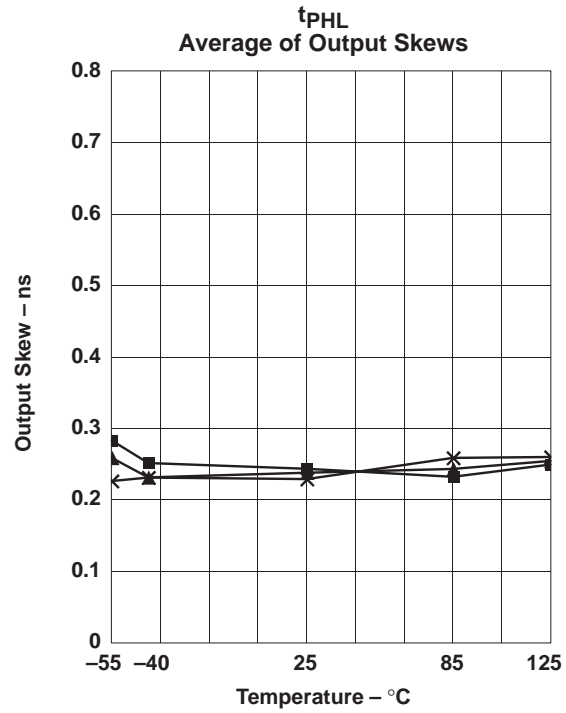
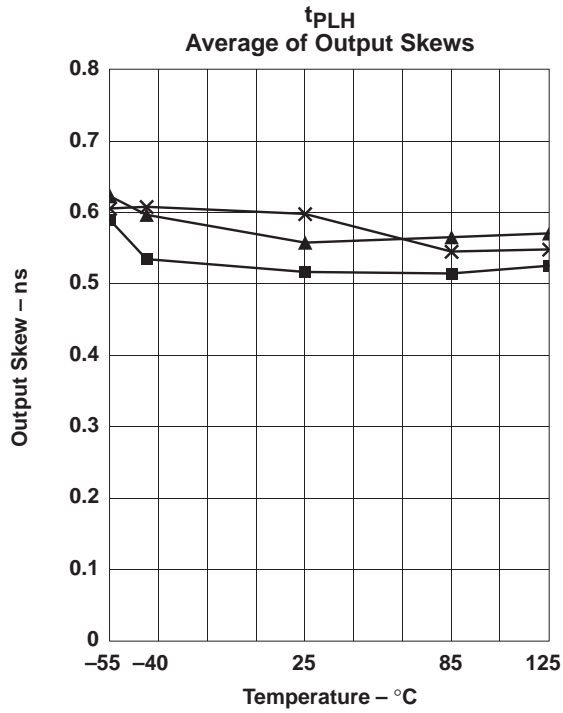

X - V_{CC} = 4.5 V
 Y - V_{CC} = 5 V
 ±V_{CC} = 5.5 V

Figure 3. 'ABT16240 – Simultaneous Switching

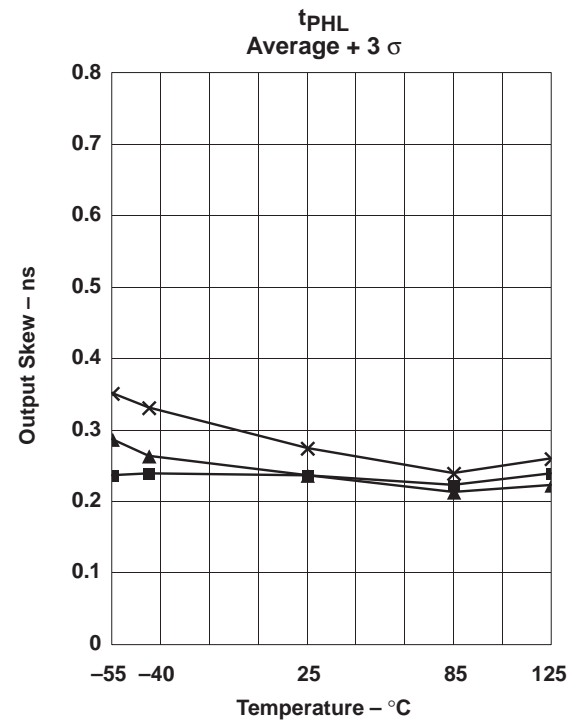
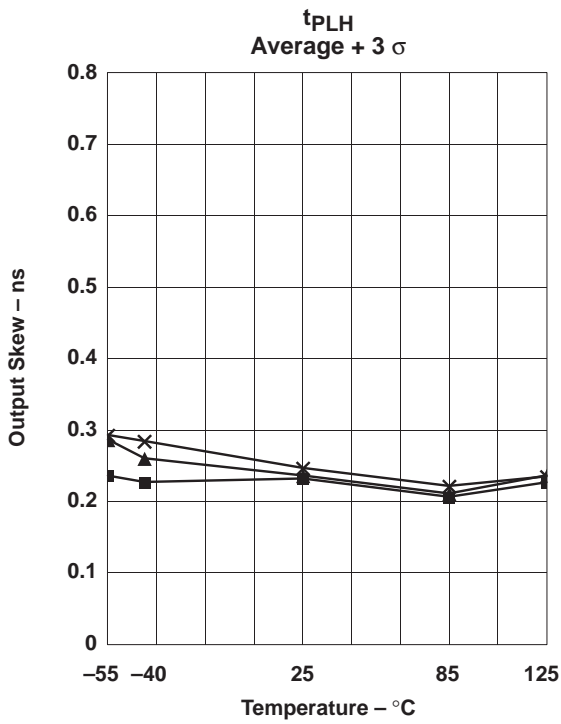
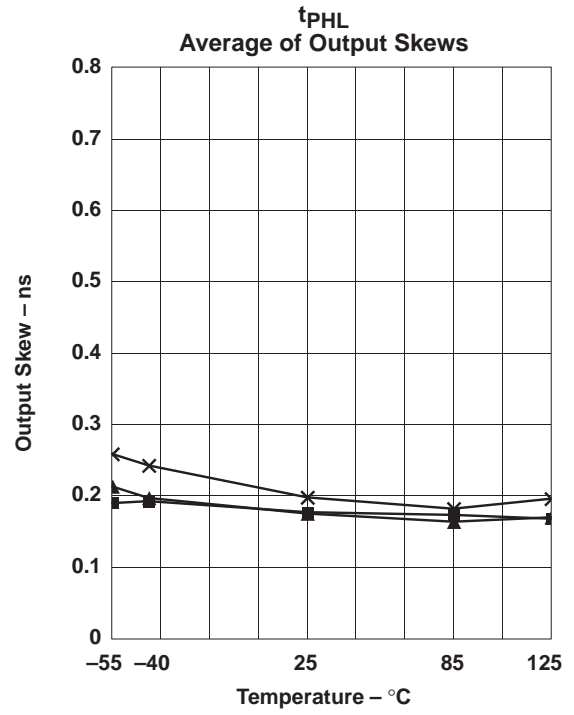
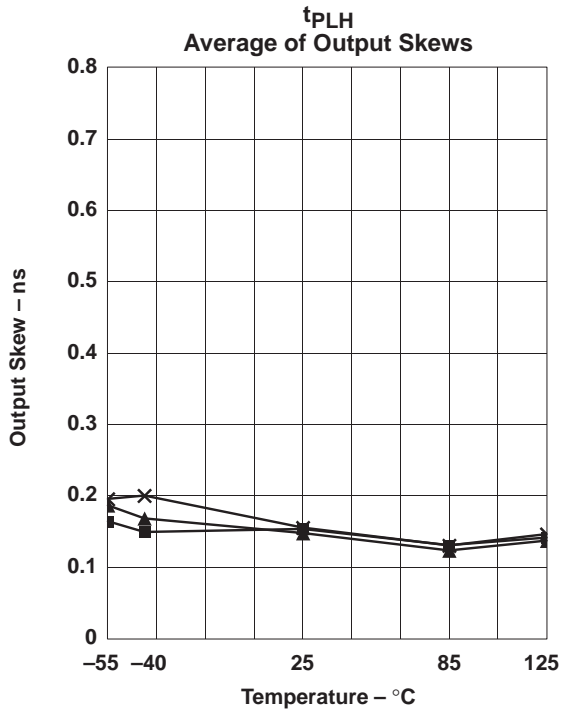

X - V_{CC} = 4.5 V
 Y - V_{CC} = 5 V
 ±V_{CC} = 5.5 V

Figure 4. 'ABT16245 – Single Switching

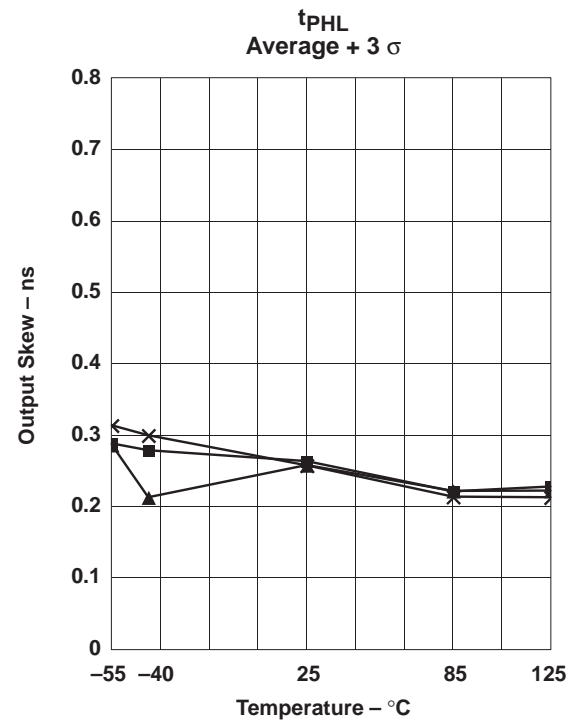
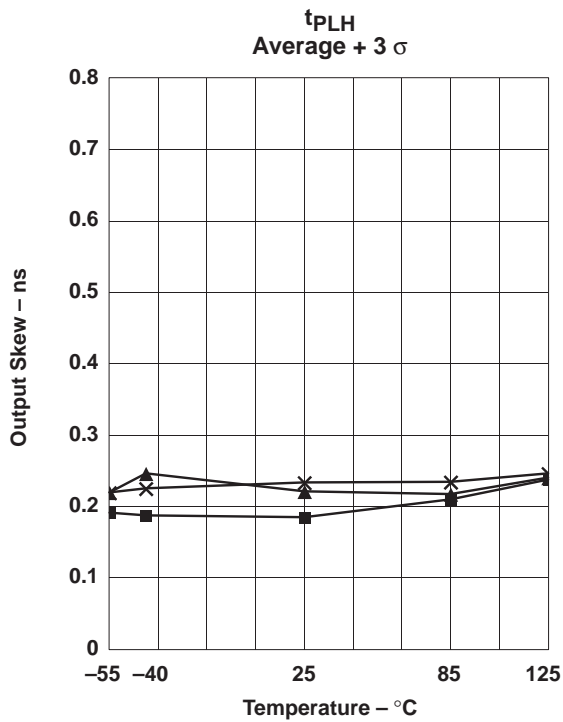
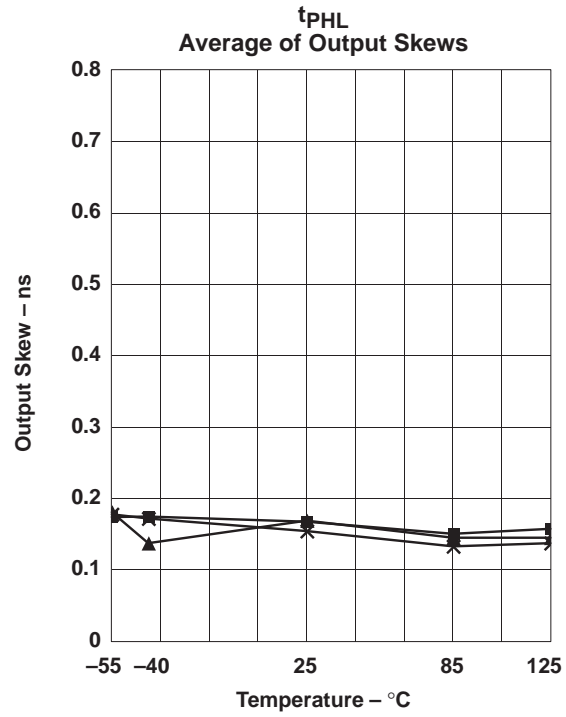
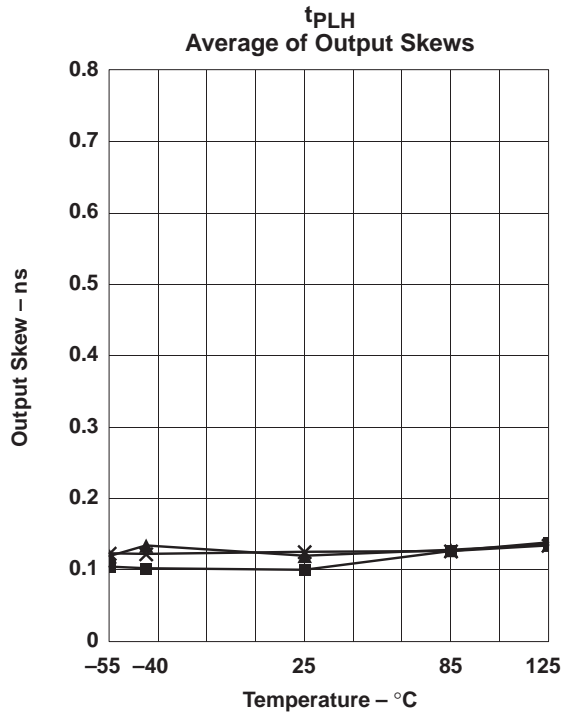

X - V_{CC} = 4.5 V
 Y - V_{CC} = 5 V
 ±V_{CC} = 5.5 V

Figure 5. 'ABT16952 – Single Switching

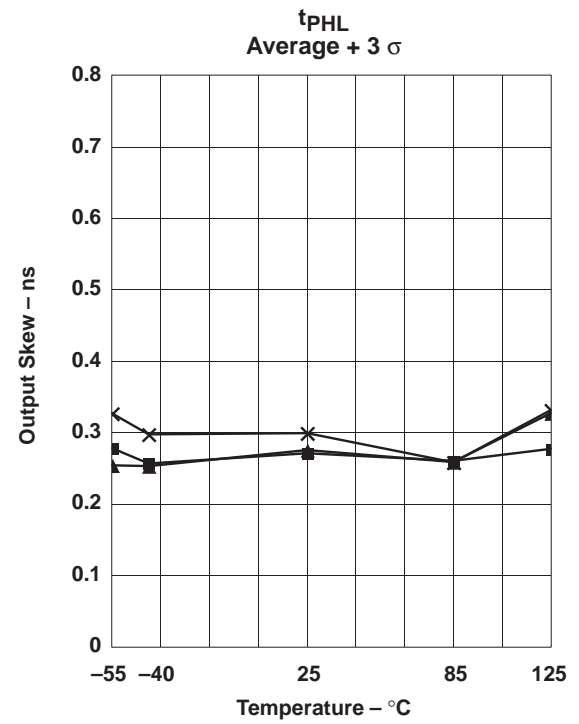
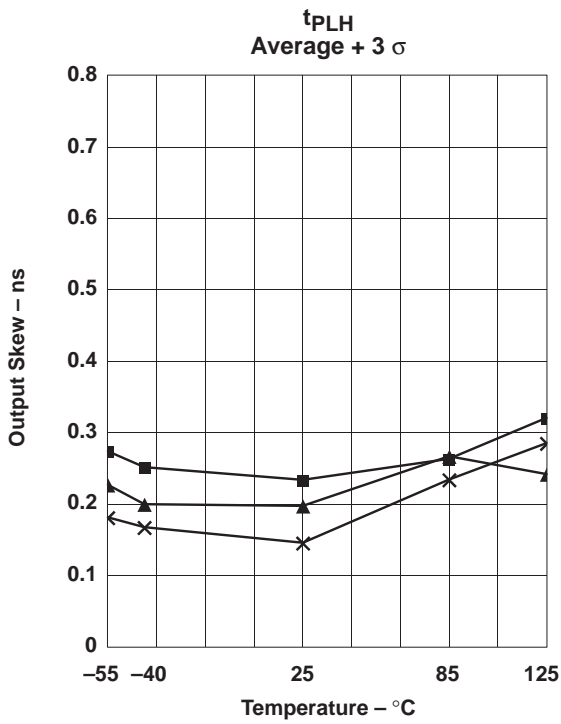
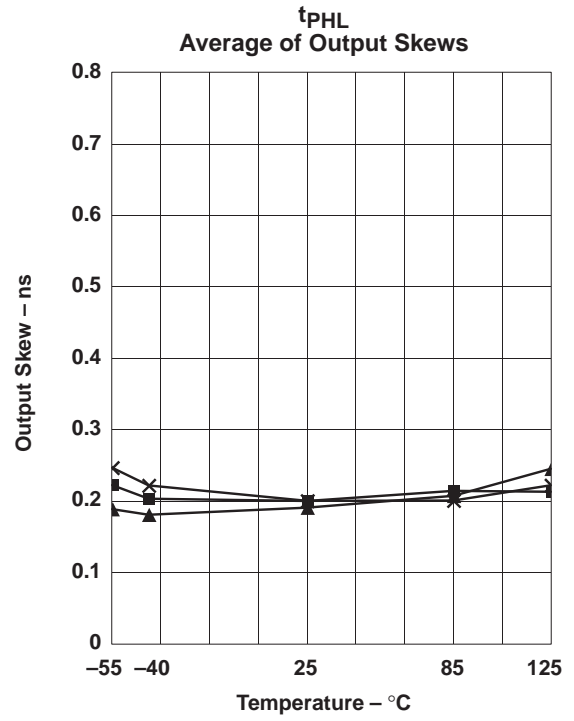
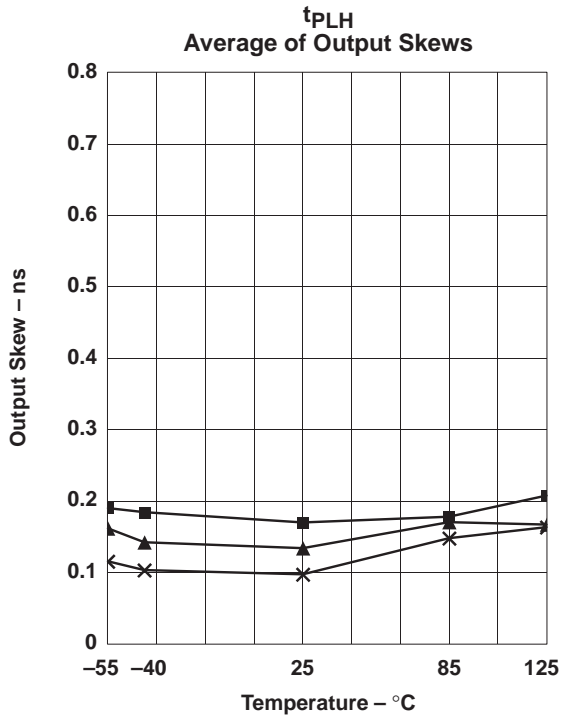

X - V_{CC} = 4.5 V
 Y - V_{CC} = 5 V
 ±V_{CC} = 5.5 V

Figure 6. 'ABT16500A – Single Switching

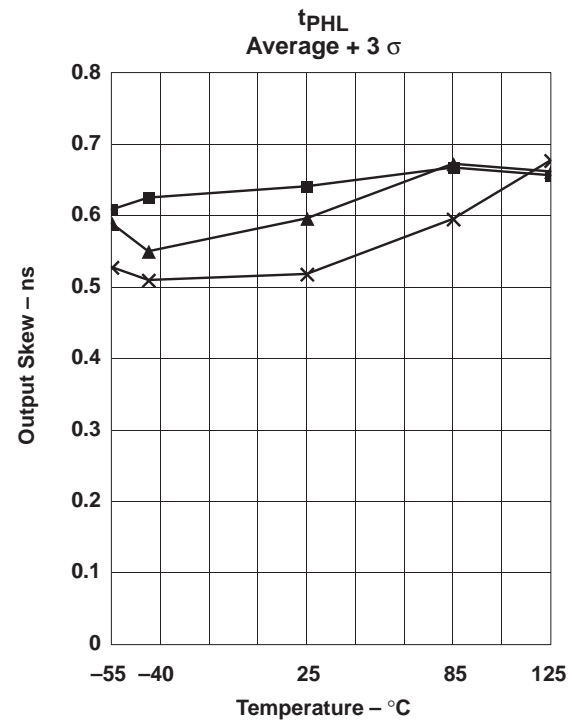
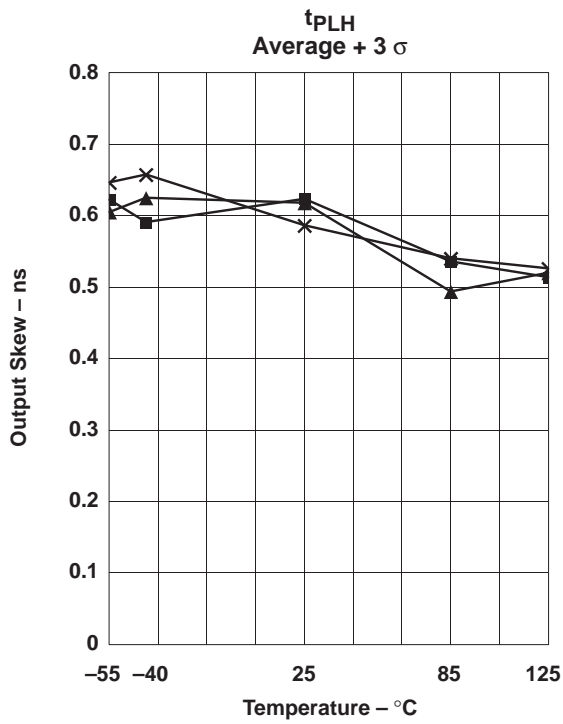
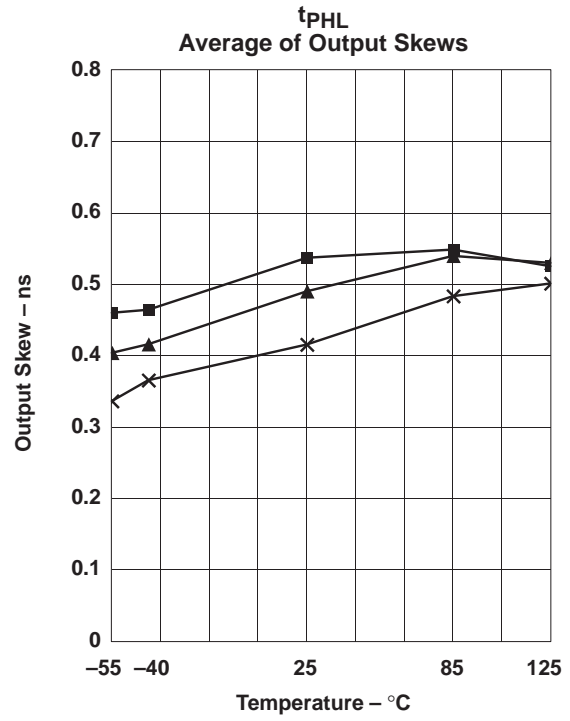
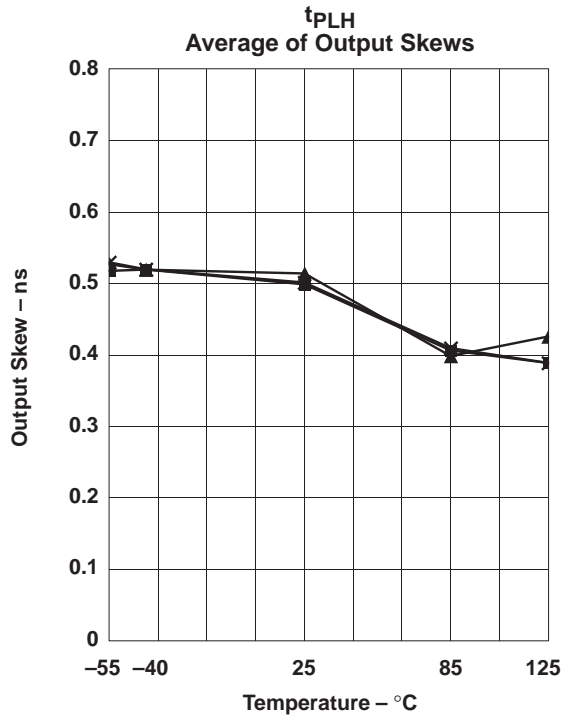

X - V_{CC} = 4.5 V
 Y - V_{CC} = 5 V
 ±V_{CC} = 5.5 V

Figure 7. 'ABT16500A – Simultaneous Switching

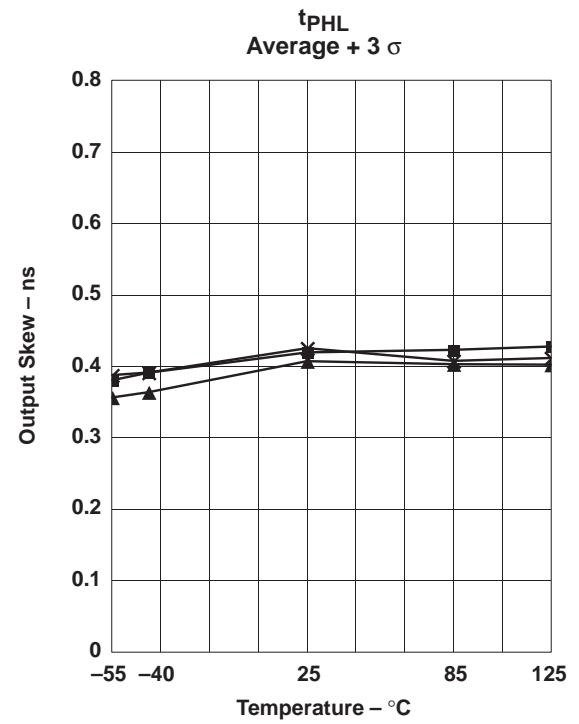
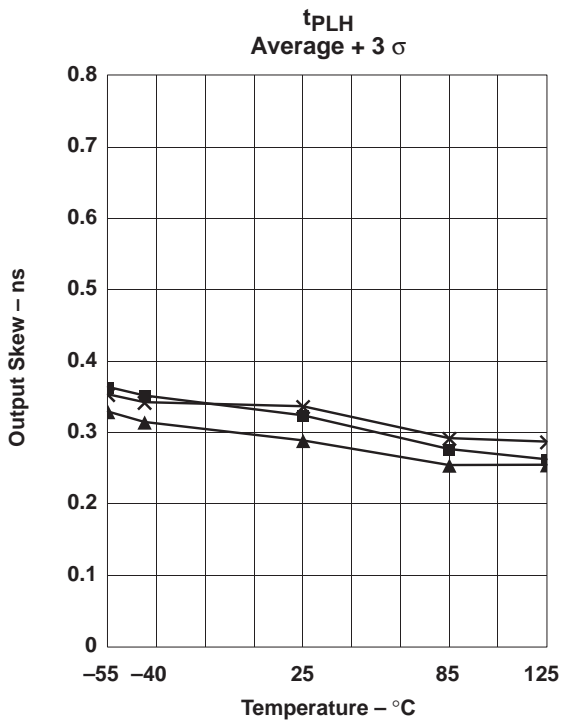
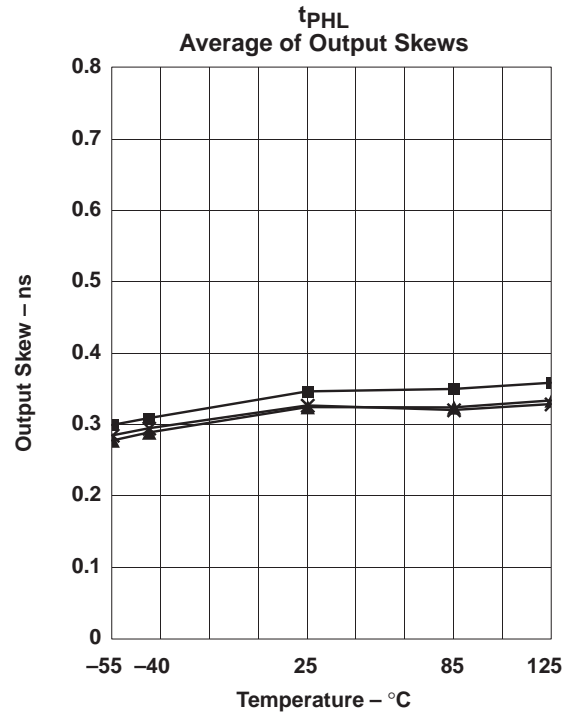
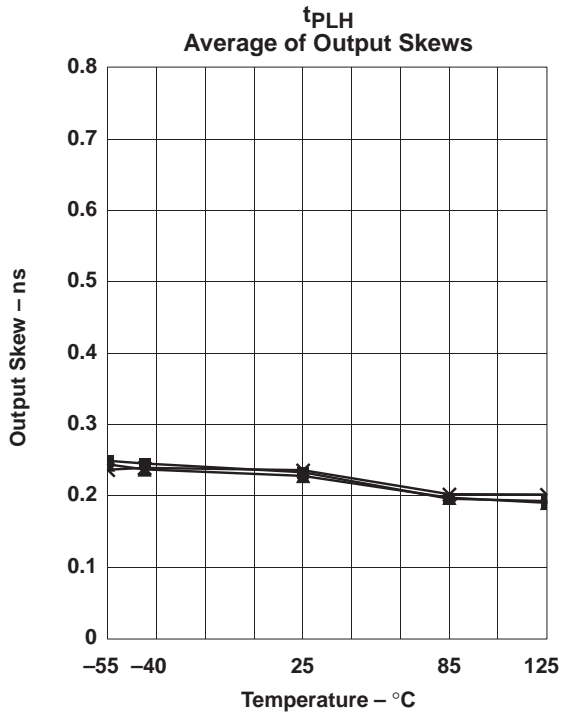

X - V_{CC} = 4.5 V
 Y - V_{CC} = 5 V
 ±V_{CC} = 5.5 V

Figure 8. 'ABT244 – Single Switching

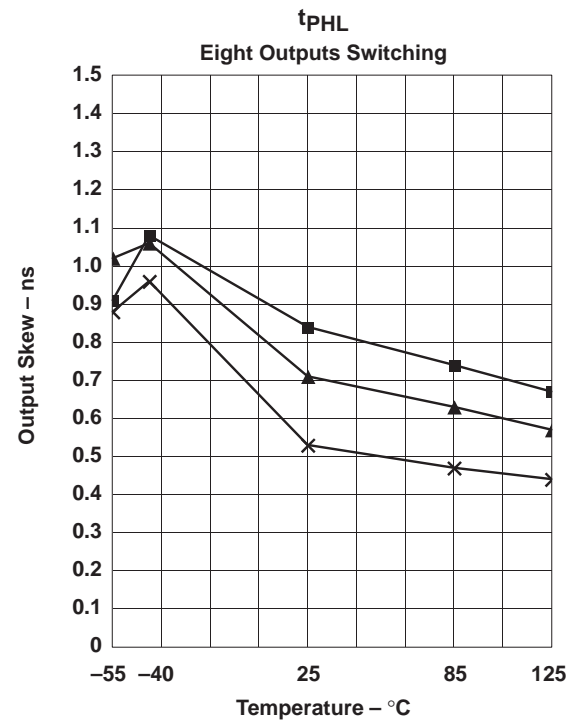
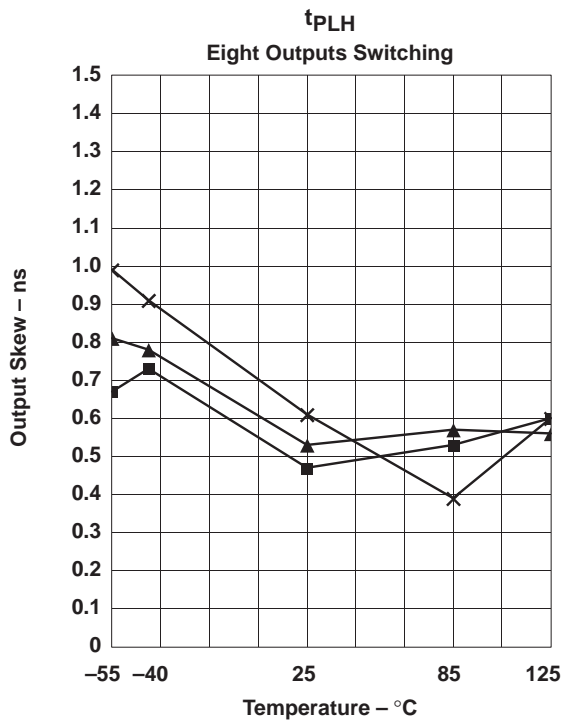
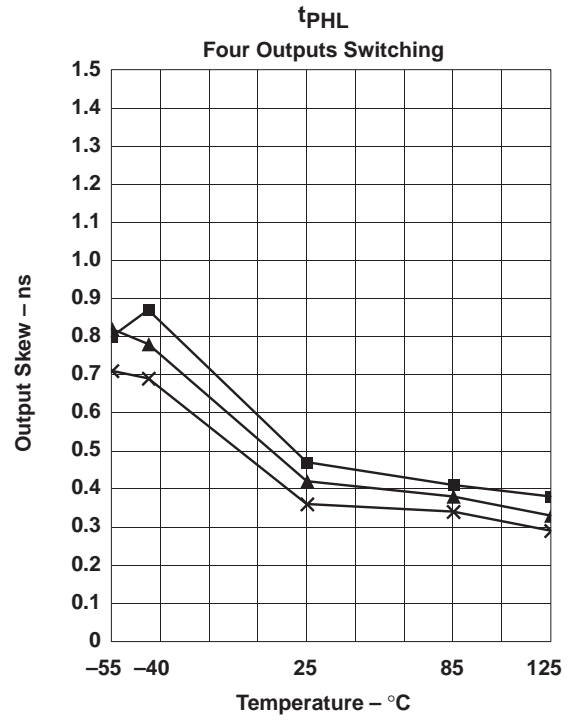
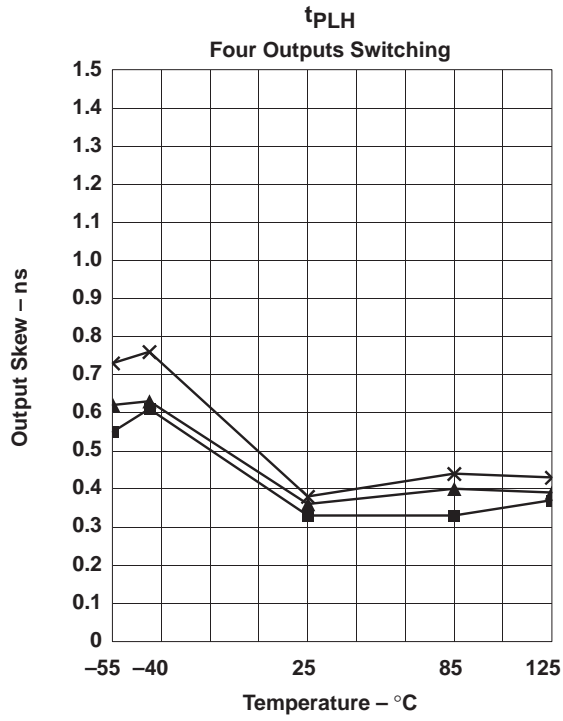

X - V_{CC} = 4.5 V
 Y - V_{CC} = 5 V
 ±V_{CC} = 5.5 V

Figure 9. 'ABT244 – Multiple-Output Switching