

SN54LS682, SN54LS684, SN54LS685, SN54LS687, SN54LS688, SN74LS682, SN74LS684 THRU SN74LS688 8-BIT MAGNITUDE/IDENTITY COMPARATORS

D2617, JANUARY 1981—REVISED MARCH 1988

SDLS008

- Compares Two-8-Bit Words
- Choice of Totem-Pole or Open-Collector Outputs
- Hysteresis at P and Q Inputs
- 'LS682 has 20-kΩ Pullup Resistors on the Q Inputs
- SN74LS686 and 'LS687 . . . JT and NT 24-Pin, 300-Mil Packages

SN54LS682, SN54LS684, SN54LS685 . . . J PACKAGE
SN74LS682, SN74LS684, SN74LS685 . . . DW OR N PACKAGE
(TOP VIEW)

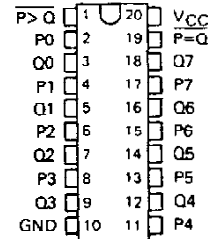

| TYPE | P = Q | P > Q | OUTPUT ENABLE | OUTPUT CONFIGURATION | 20-kΩ PULLUP |
|-----------|-------|-------|---------------|----------------------|--------------|
| 'LS682 | yes | yes | no | totem-pole | yes |
| 'LS684 | yes | yes | no | totem-pole | no |
| 'LS685 | yes | yes | no | open-collector | no |
| SN74LS686 | yes | yes | yes | totem-pole | no |
| 'LS687 | yes | yes | yes | open-collector | no |
| 'LS688 | yes | no | yes | totem-pole | no |

SN54LS682, SN54LS684, SN54LS685 . . . FK PACKAGE
(TOP VIEW)

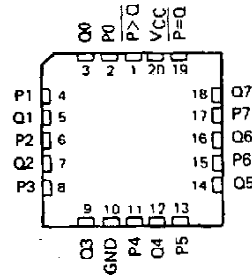

SN54LS687 . . . JT PACKAGE
SN74LS686, SN74LS687 . . . DW OR NT PACKAGE
(TOP VIEW)

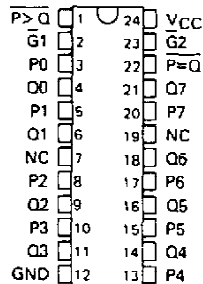

SN54LS688 . . . J PACKAGE
SN74LS688 . . . DW OR N PACKAGE
(TOP VIEW)

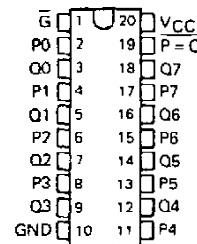

SN54LS687 . . . FK PACKAGE
(TOP VIEW)

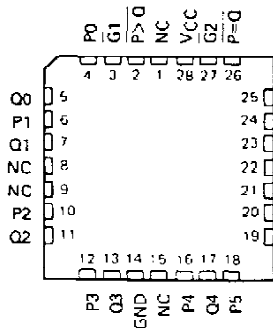

NC—No internal connection

SN54LS688 . . . FK PACKAGE
(TOP VIEW)

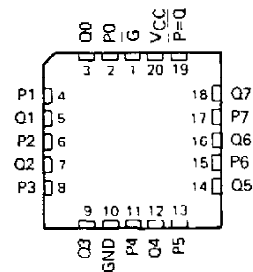

PRODUCTION DATA documents contain information current as of publication date. Products conform to specifications per the terms of Texas Instruments standard warranty. Production processing does not necessarily include testing of all parameters.



POST OFFICE BOX 655012 • DALLAS, TEXAS 75265

SN54LS682, SN54LS684, SN54LS685, SN54LS687, SN54LS688 SN74LS682, SN74LS684 THRU SN74LS688 8-BIT MAGNITUDE/IDENTITY COMPARATORS

description

These magnitude comparators perform comparisons of two eight-bit binary or BCD words. All types provide $\overline{P=Q}$ outputs and all except 'LS688 provide $\overline{P>Q}$ outputs as well. The 'LS682, 'LS684, 'LS686, and 'LS688 have totem-pole outputs, while the 'LS685 and 'LS687 have open-collector outputs. The 'LS682 features 20-k Ω pullup termination resistors on the Q inputs for analog or switch data.

FUNCTION TABLE

| DATA P, Q | ENABLES | | OUTPUTS | |
|--------------|-----------------------------------|-----------------|------------------|------------------|
| | $\overline{G1}$, $\overline{G1}$ | $\overline{G2}$ | $\overline{P=Q}$ | $\overline{P>Q}$ |
| P=Q | L | X | L | H |
| P>Q | X | L | H | L |
| P<Q | X | X | H | H |
| P=Q | H | X | H | H |
| P>Q | X | H | H | H |
| X | H | H | H | H |

- NOTES: 1. The last three lines of the function table applies only to the devices having enable inputs, i.e., 'LS686 thru 'LS688.
2. The $\overline{P<Q}$ function can be generated by applying the $\overline{P=Q}$ and $\overline{P>Q}$ outputs to a 2-input NAND gate.
3. For 'LS686 and 'LS687, $\overline{G1}$ enables $\overline{P=Q}$ and $\overline{G2}$ enables $\overline{P>Q}$.

logic symbols†



†These symbols are in accordance with ANSI/IEEE Std 91-1984 and IEC Publication 617-12. Pin numbers shown are for DW, J, JT, N, and NT packages.

**SN54LS682, SN54LS684, SN54LS685, SN54LS687, SN54LS688,
SN74LS682, SN74LS684 THRU SN74LS688
8-BIT MAGNITUDE/IDENTITY COMPARATORS**

logic symbols† (continued)



†These symbols are in accordance with ANSI/IEEE Std 91-1984 and IEC Publication 617-12. Pin numbers shown are for DW, J, JT, N, and NT packages.

schematics of inputs and outputs



**SN54LS682, SN54LS684, SN54LS685
 SN74LS682, SN74LS684, SN74LS685
 8-BIT MAGNITUDE/IDENTITY COMPARATORS**

LS682, LS684, LS685 logic diagram (positive logic)

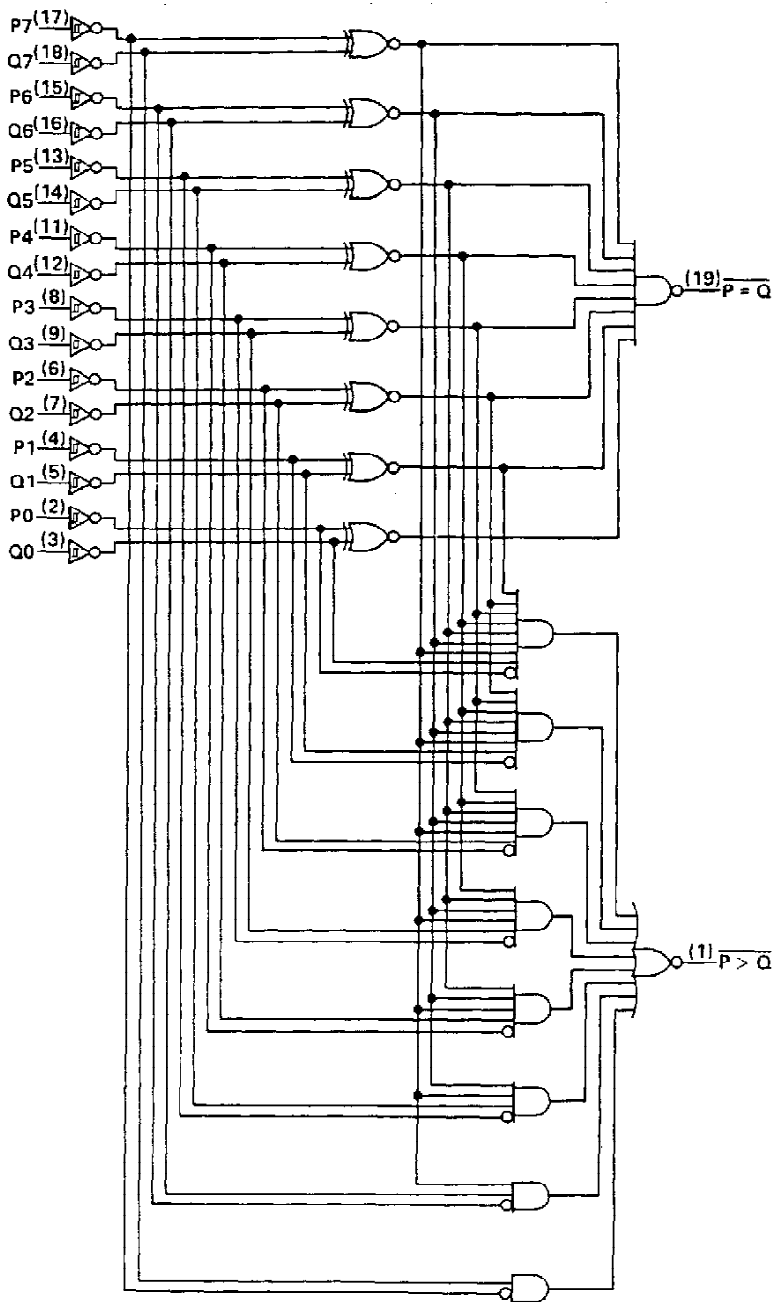

Pin numbers shown are for DW, J, and N packages.

SN54LS687
SN74LS686, SN74LS687
8-BIT MAGNITUDE/IDENTITY COMPARATORS

'LS686, 'LS687 logic diagram (positive logic)



Pin numbers shown are for DW, JT, and NT packages.

TEXAS
INSTRUMENTS

POST OFFICE BOX 655012 • DALLAS, TEXAS 75265

**SN54LS682, SN54LS684, SN54LS685, SN54LS687, SN54LS688
SN74LS682, SN74LS684 THRU SN74LS688
8-BIT IDENTITY COMPARATORS**

'LS688 logic diagram (positive logic)



Pin numbers shown are for DW, J, and N packages.

absolute maximum ratings over operating free-air temperature range (unless otherwise noted)

| | |
|---|------------------|
| Supply voltage, V_{CC} (see Note 1) | 7 V |
| Input voltage: Q inputs of 'LS682 | 5.5 V |
| All other inputs | 7 V |
| Off-state output voltage: 'LS685, 'LS687 | 7 V |
| Operating free-air temperature range: | |
| SN54LS682, SN54LS684, SN54LS685, SN54LS687, SN54LS688 | -55 °C to 125 °C |
| SN74LS682, SN74LS684 thru SN74LS688 | 0 °C to 70 °C |
| Storage temperature range | -65 °C to 150 °C |

NOTE 1: Voltage values are with respect to network ground terminal.

**SN54LS682, SN54LS684, SN54LS688
SN74LS682, SN74LS684, SN74LS686, SN74LS688
8-BIT MAGNITUDE/IDENTITY COMPARATORS WITH TOTEM-POLE OUTPUTS**

recommended operating conditions

| | SN54LS' | | | SN74LS' | | | UNIT |
|---------------------------------------|---------|-----|------|---------|-----|------|--------------|
| | MIN | NOM | MAX | MIN | NOM | MAX | |
| Supply voltage, V_{CC} | 4.5 | 5 | 5.5 | 4.85 | 5 | 5.25 | V |
| High-level output current, I_{OH} | | | -400 | | | -400 | μ A |
| Low-level output current, I_{OL} | | | 12 | | | 24 | mA |
| Operating free-air temperature, T_A | -55 | | 125 | 0 | | 70 | $^{\circ}$ C |

electrical characteristics over recommended operating free-air temperature range (unless otherwise noted)

| PARAMETER | | TEST CONDITIONS† | SN54LS' | | | SN74LS' | | | UNIT | |
|-------------------|--|---|---|------|------|---------|--------------------------|------|---------|----|
| | | | MIN | TYP‡ | MAX | MIN | TYP‡ | MAX | | |
| V_{IH} | High-level input voltage | | 2 | | | 2 | | | V | |
| V_{IL} | Low-level input voltage | | | | 0.7 | | | 0.8 | V | |
| $V_{T+} - V_{T-}$ | Hysteresis | P or Q inputs | | 0.4 | | | 0.4 | | V | |
| V_{IK} | Input clamp voltage | $V_{CC} = \text{MIN}$ | | | -1.5 | | | -1.5 | V | |
| V_{OH} | High-level output voltage | $V_{CC} = \text{MIN}$, $V_{IH} = 2 \text{ V}$, $V_{IL} = V_{IL\text{max}}$, $I_{OH} = -400 \mu\text{A}$ | 2.5 | | | 2.7 | | | V | |
| V_{OL} | Low-level output voltage | $V_{CC} = \text{MIN}$, $V_{IH} = 2 \text{ V}$, $V_{IL} = V_{IL\text{max}}$ | $I_{OL} = 12 \text{ mA}$ | | 0.25 | 0.4 | $I_{OL} = 24 \text{ mA}$ | | V | |
| | | | $I_{OL} = 24 \text{ mA}$ | | | | 0.35 | 0.5 | | |
| I_I | Input current at maximum input voltage | Q inputs, 'LS682 | $V_{CC} = \text{MAX}$, $V_I = 5.5 \text{ V}$ | | | | | | mA | |
| | | All other inputs | $V_{CC} = \text{MAX}$, $V_I = 7 \text{ V}$ | | | 0.1 | | | | |
| I_{IH} | High-level input current | | $V_{CC} = \text{MAX}$, $V_I = 2.7 \text{ V}$ | | | 20 | | | μ A | |
| I_{IL} | Low-level input current | Q inputs, 'LS682 | $V_{CC} = \text{MAX}$, $V_I = 0.4 \text{ V}$ | | | -0.4 | | | mA | |
| | | All other inputs | | | | -0.2 | | | | |
| I_{OS}^{\S} | Short-circuit output current | | $V_{CC} = \text{MAX}$, $V_O = 0$ | | | -20 | -100 | -20 | -100 | mA |
| I_{CC} | Supply current | 'LS682 | $V_{CC} = \text{MAX}$, See Note 1 | | | 42 | 70 | 42 | 70 | mA |
| | | 'LS684 | | | | 40 | 65 | 40 | 65 | |
| | | 'LS686 | | | | 44 | 75 | 44 | 75 | |
| | | 'LS688 | | | | 40 | 65 | 40 | 65 | |

† For conditions shown as MIN or MAX, use the appropriate values specified under recommended operating conditions.

‡ All typical values are at $V_{CC} = 5 \text{ V}$, $T_A = 25^{\circ}\text{C}$.

§ Not more than one output should be shorted at a time, and duration of the short-circuit should not exceed one second.

NOTE 1: I_{CC} is measured with any \bar{Q} inputs grounded, all other inputs at 4.5 V, and all outputs open.

SN54LS682, SN54LS684, SN54LS688
SN74LS682, SN74LS684, SN74LS686, SN74LS688
8-BIT MAGNITUDE/IDENTITY COMPARATORS WITH TOTEM-POLE OUTPUTS

switching characteristics, $V_{CC} = 5\text{ V}$, $T_A = 25^\circ\text{C}$

| PARAMETER† | FROM (INPUTS) | TO (OUTPUT) | TEST CONDITIONS | 'LS682 | | 'LS684 | | 'LS686 | | 'LS688 | | UNIT |
|------------|-------------------------------|------------------|--|--------|-----|--------|-----|--------|-----|--------|-----|------|
| | | | | MIN | TYP | MAX | MIN | TYP | MAX | MIN | TYP | |
| t_{PLH} | P | $\overline{P=Q}$ | $R_L = 667\ \Omega$, $C_L = 45\ \text{pF}$, All other inputs low, See Note 2 | 13 | 25 | 15 | 25 | 13 | 25 | 12 | 18 | ns |
| t_{PHL} | | | | 15 | 25 | 17 | 25 | 20 | 30 | 17 | 23 | |
| t_{PLH} | Q | $\overline{P=Q}$ | | 14 | 25 | 16 | 25 | 13 | 25 | 12 | 18 | ns |
| t_{PHL} | | | | 15 | 25 | 15 | 25 | 21 | 30 | 17 | 23 | |
| t_{PLH} | $\overline{Q}, \overline{Q}1$ | $\overline{P=Q}$ | | | | | | 11 | 20 | 12 | 18 | ns |
| t_{PHL} | | | | | | | | 19 | 30 | 13 | 20 | |
| t_{PLH} | P | $\overline{P>Q}$ | | | 20 | 30 | 22 | 30 | 19 | 30 | | ns |
| t_{PHL} | | | | | 15 | 30 | 17 | 30 | 15 | 30 | | |
| t_{PLH} | Q | $\overline{P>Q}$ | | | 21 | 30 | 24 | 30 | 18 | 30 | | ns |
| t_{PHL} | | | | | 19 | 30 | 20 | 30 | 19 | 30 | | |
| t_{PLH} | $\overline{Q}2$ | $\overline{P>Q}$ | | | | | | | 21 | 30 | | ns |
| t_{PHL} | | | | | | | | | 16 | 25 | | |

† t_{PLH} = propagation delay time, low-to-high-level outputs; t_{PHL} = propagation delay time, high-to-low-level output.
 NOTE 2: Load circuits and voltage waveforms are shown in Section 1.

SN54LS685, SN54LS687
SN74LS685, SN74LS687, SN74LS688

8-BIT MAGNITUDE/IDENTITY COMPARATORS WITH TOTEM-POLE OUTPUTS

recommended operating conditions

| | SN54LS [†] | | | SN74LS [†] | | | UNIT |
|---------------------------------------|---------------------|-----|-----|---------------------|-----|------|------|
| | MIN | NOM | MAX | MIN | NOM | MAX | |
| Supply voltage, V_{CC} | 4.5 | 5 | 5.5 | 4.85 | 5 | 5.25 | V |
| High-level output current, I_{OH} | | | 5.5 | | | 5.5 | V |
| Low-level output current, I_{OL} | | | 12 | | | 24 | mA |
| Operating free-air temperature, T_A | -55 | | 125 | 0 | | 70 | °C |

electrical characteristics over recommended operating free-air temperature range (unless otherwise noted)

| PARAMETER | | TEST CONDITIONS [†] | SN54LS [†] | | | SN74LS [†] | | | UNIT | |
|-------------------|---------------------------|---|--------------------------|-----|------|---------------------|--------------------------|------|---------------|-----|
| | | | MIN | TYP | MAX | MIN | TYP | MAX | | |
| V_{IH} | High-level input voltage | | 2 | | | 2 | | | V | |
| V_{IL} | Low-level input voltage | | | | 0.7 | | | 0.8 | V | |
| $V_{T+} - V_{T-}$ | Hysteresis | P or Q inputs | 0.4 | | | 0.4 | | | V | |
| V_{IK} | Input clamp voltage | $V_{CC} = \text{MIN}, I_I = -18 \text{ mA}$ | | | -1.5 | | | -1.5 | V | |
| I_{OH} | High-level output voltage | $V_{CC} = \text{MIN}, V_{IH} = 2 \text{ V}, V_{IL} = V_{ILmax}, V_{OH} = 5.5 \text{ V}$ | | | 250 | | | 100 | μA | |
| V_{OL} | Low-level output voltage | $V_{CC} = \text{MIN}, V_{IH} = 2 \text{ V}, V_{IL} = V_{ILmax}$ | $I_{OL} = 12 \text{ mA}$ | | 0.25 | 0.4 | $I_{OL} = 12 \text{ mA}$ | | 0.25 | 0.4 |
| | | | $I_{OL} = 24 \text{ mA}$ | | | | $I_{OL} = 24 \text{ mA}$ | | 0.35 | 0.5 |
| I_I | | $V_{CC} = \text{MAX}, V_I = 7 \text{ V}$ | | | 0.1 | | | 0.1 | mA | |
| I_{IH} | High-level input current | $V_{CC} = \text{MAX}, V_I = 2.7 \text{ V}$ | | | 20 | | | 20 | μA | |
| I_{IL} | Low-level input current | $V_{CC} = \text{MAX}, V_I = 0.4 \text{ V}$ | | | -0.2 | | | -0.2 | mA | |
| I_{CC} | Supply current | 'LS685 | | | 40 | 65 | | | 40 | 65 |
| | | 'LS687 | | | 44 | 75 | | | 44 | 75 |

[†]For conditions shown as MIN or MAX, use the appropriate values specified under recommended operating conditions.

[‡]All typical values are at $V_{CC} = 5 \text{ V}, T_A = 25^\circ\text{C}$.

NOTE 1: I_{CC} is measure with any \bar{Q} inputs grounded, all other inputs at 4.5 V, and all outputs open.



SN54LS685, SN54LS687
SN74LS685, SN74LS687
8-BIT MAGNITUDE/IDENTITY COMPARATORS WITH OPEN-COLLECTOR OUTPUTS

switching characteristics, $V_{CC} = 5\text{ V}$, $T_A = 25^\circ\text{C}$

| PARAMETER | FROM (INPUT) | TO (OUTPUT) | TEST CONDITIONS | 'LS685 | | | 'LS687 | | | UNIT |
|-----------|-------------------------------|------------------|--|--------|-----|-----|--------|-----|-----|------|
| | | | | MIN | TYP | MAX | MIN | TYP | MAX | |
| t_{PLH} | P | $\overline{P=Q}$ | $R_L = 667\ \Omega$, $C_L = 45\ \text{pF}$, All other inputs low, See Note 2 | 30 | 45 | | 24 | 35 | ns | |
| t_{PHL} | | | | 19 | 35 | | 20 | 30 | | |
| t_{PLH} | Q | $\overline{P=Q}$ | | 24 | 45 | | 24 | 35 | ns | |
| t_{PHL} | | | | 23 | 35 | | 20 | 30 | | |
| t_{PLH} | $\overline{Q}, \overline{Q1}$ | $\overline{P=Q}$ | | | | | 21 | 35 | ns | |
| t_{PHL} | | | | | | | 18 | 30 | | |
| t_{PLH} | P | $\overline{P>Q}$ | | | 32 | 45 | | 24 | 35 | ns |
| t_{PHL} | | | | | 16 | 35 | | 16 | 30 | |
| t_{PLH} | Q | $\overline{P>Q}$ | | | 30 | 45 | | 24 | 35 | ns |
| t_{PHL} | | | | | 20 | 35 | | 16 | 30 | |
| t_{PLH} | $\overline{Q2}$ | $\overline{P>Q}$ | | | | 24 | 35 | ns | | |
| t_{PHL} | | | | | | 15 | 30 | | | |

t_{PLH} = propagation delay time, low-to-high-level outputs; t_{PHL} = propagation delay time, high-to-low-level output.
 NOTE 2: Load circuits and voltage waveforms are shown in Section 1.

PACKAGING INFORMATION

| Orderable Device | Status (1) | Package Type | Package Drawing | Pins | Package Qty | Eco Plan (2) | Lead finish/ Ball material (6) | MSL Peak Temp (3) | Op Temp (°C) | Device Marking (4/5) | Samples |
|------------------|---------------|--------------|-----------------|------|-------------|------------------|--------------------------------------|----------------------|--------------|-------------------------------|-------------------------|
| 8415101RA | ACTIVE | CDIP | J | 20 | 1 | Non-RoHS & Green | SNPB | N / A for Pkg Type | -55 to 125 | 8415101RA SNJ54LS682J | Samples |
| 8415101SA | ACTIVE | CFP | W | 20 | 1 | Non-RoHS & Green | SNPB | N / A for Pkg Type | -55 to 125 | 8415101SA SNJ54LS682W | Samples |
| 8415101SA | ACTIVE | CFP | W | 20 | 1 | Non-RoHS & Green | SNPB | N / A for Pkg Type | -55 to 125 | 8415101SA SNJ54LS682W | Samples |
| 84152012A | ACTIVE | LCCC | FK | 20 | 1 | Non-RoHS & Green | SNPB | N / A for Pkg Type | -55 to 125 | 84152012A SNJ54LS 684FK | Samples |
| 8415201RA | ACTIVE | CDIP | J | 20 | 1 | Non-RoHS & Green | SNPB | N / A for Pkg Type | -55 to 125 | 8415201RA SNJ54LS684J | Samples |
| 84153012A | ACTIVE | LCCC | FK | 20 | 1 | Non-RoHS & Green | SNPB | N / A for Pkg Type | -55 to 125 | 84153012A SNJ54LS 688FK | Samples |
| 8415301RA | ACTIVE | CDIP | J | 20 | 1 | Non-RoHS & Green | SNPB | N / A for Pkg Type | -55 to 125 | 8415301RA SNJ54LS688J | Samples |
| 8415301SA | ACTIVE | CFP | W | 20 | 1 | Non-RoHS & Green | SNPB | N / A for Pkg Type | -55 to 125 | 8415301SA SNJ54LS688W | Samples |
| SN54LS682J | ACTIVE | CDIP | J | 20 | 1 | Non-RoHS & Green | SNPB | N / A for Pkg Type | -55 to 125 | SN54LS682J | Samples |
| SN54LS682J | ACTIVE | CDIP | J | 20 | 1 | Non-RoHS & Green | SNPB | N / A for Pkg Type | -55 to 125 | SN54LS682J | Samples |
| SN54LS684J | ACTIVE | CDIP | J | 20 | 1 | Non-RoHS & Green | SNPB | N / A for Pkg Type | -55 to 125 | SN54LS684J | Samples |
| SN54LS688J | ACTIVE | CDIP | J | 20 | 1 | Non-RoHS & Green | SNPB | N / A for Pkg Type | -55 to 125 | SN54LS688J | Samples |
| SN74LS682DW | ACTIVE | SOIC | DW | 20 | 25 | RoHS & Green | NIPDAU | Level-1-260C-UNLIM | 0 to 70 | LS682 | Samples |
| SN74LS682DW | ACTIVE | SOIC | DW | 20 | 25 | RoHS & Green | NIPDAU | Level-1-260C-UNLIM | 0 to 70 | LS682 | Samples |
| SN74LS682DWR | ACTIVE | SOIC | DW | 20 | 2000 | RoHS & Green | NIPDAU | Level-1-260C-UNLIM | 0 to 70 | LS682 | Samples |
| SN74LS682DWR | ACTIVE | SOIC | DW | 20 | 2000 | RoHS & Green | NIPDAU | Level-1-260C-UNLIM | 0 to 70 | LS682 | Samples |

| Orderable Device | Status (1) | Package Type | Package Drawing | Pins | Package Qty | Eco Plan (2) | Lead finish/ Ball material (6) | MSL Peak Temp (3) | Op Temp (°C) | Device Marking (4/5) | Samples |
|------------------|---------------|--------------|-----------------|------|-------------|------------------|--------------------------------------|----------------------|--------------|--------------------------|-------------------------|
| SN74LS682DWRG4 | ACTIVE | SOIC | DW | 20 | 2000 | TBD | Call TI | Call TI | 0 to 70 | | Samples |
| SN74LS682DWRG4 | ACTIVE | SOIC | DW | 20 | 2000 | TBD | Call TI | Call TI | 0 to 70 | | Samples |
| SN74LS682N | ACTIVE | PDIP | N | 20 | 20 | RoHS & Non-Green | NIPDAU | N / A for Pkg Type | 0 to 70 | SN74LS682N | Samples |
| SN74LS682N | ACTIVE | PDIP | N | 20 | 20 | RoHS & Non-Green | NIPDAU | N / A for Pkg Type | 0 to 70 | SN74LS682N | Samples |
| SN74LS682NSR | ACTIVE | SO | NS | 20 | 2000 | RoHS & Green | NIPDAU | Level-1-260C-UNLIM | 0 to 70 | 74LS682 | Samples |
| SN74LS682NSR | ACTIVE | SO | NS | 20 | 2000 | RoHS & Green | NIPDAU | Level-1-260C-UNLIM | 0 to 70 | 74LS682 | Samples |
| SN74LS684DWR | ACTIVE | SOIC | DW | 20 | 2000 | RoHS & Green | NIPDAU | Level-1-260C-UNLIM | 0 to 70 | LS684 | Samples |
| SN74LS684N | ACTIVE | PDIP | N | 20 | 20 | RoHS & Non-Green | NIPDAU | N / A for Pkg Type | 0 to 70 | SN74LS684N | Samples |
| SN74LS684NSR | ACTIVE | SO | NS | 20 | 2000 | RoHS & Green | NIPDAU | Level-1-260C-UNLIM | 0 to 70 | 74LS684 | Samples |
| SN74LS688DW | ACTIVE | SOIC | DW | 20 | 25 | RoHS & Green | NIPDAU | Level-1-260C-UNLIM | 0 to 70 | LS688 | Samples |
| SN74LS688DWR | ACTIVE | SOIC | DW | 20 | 2000 | RoHS & Green | NIPDAU | Level-1-260C-UNLIM | 0 to 70 | LS688 | Samples |
| SN74LS688N | ACTIVE | PDIP | N | 20 | 20 | RoHS & Non-Green | NIPDAU | N / A for Pkg Type | 0 to 70 | SN74LS688N | Samples |
| SN74LS688NE4 | ACTIVE | PDIP | N | 20 | 20 | RoHS & Non-Green | NIPDAU | N / A for Pkg Type | 0 to 70 | SN74LS688N | Samples |
| SN74LS688NSR | ACTIVE | SO | NS | 20 | 2000 | RoHS & Green | NIPDAU | Level-1-260C-UNLIM | 0 to 70 | 74LS688 | Samples |
| SNJ54LS682J | ACTIVE | CDIP | J | 20 | 1 | Non-RoHS & Green | SNPB | N / A for Pkg Type | -55 to 125 | 8415101RA SNJ54LS682J | Samples |
| SNJ54LS682J | ACTIVE | CDIP | J | 20 | 1 | Non-RoHS & Green | SNPB | N / A for Pkg Type | -55 to 125 | 8415101RA SNJ54LS682J | Samples |
| SNJ54LS682W | ACTIVE | CFP | W | 20 | 1 | Non-RoHS & Green | SNPB | N / A for Pkg Type | -55 to 125 | 8415101SA SNJ54LS682W | Samples |
| SNJ54LS682W | ACTIVE | CFP | W | 20 | 1 | Non-RoHS & Green | SNPB | N / A for Pkg Type | -55 to 125 | 8415101SA SNJ54LS682W | Samples |
| SNJ54LS684FK | ACTIVE | LCCC | FK | 20 | 1 | Non-RoHS & Green | SNPB | N / A for Pkg Type | -55 to 125 | 84152012A SNJ54LS | Samples |

| Orderable Device | Status (1) | Package Type | Package Drawing | Pins | Package Qty | Eco Plan (2) | Lead finish/ Ball material (6) | MSL Peak Temp (3) | Op Temp (°C) | Device Marking (4/5) | Samples |
|------------------|---------------|--------------|-----------------|------|-------------|---------------------|--------------------------------------|----------------------|--------------|-------------------------------|-------------------------|
| | | | | | | | | | | 684FK | |
| SNJ54LS684J | ACTIVE | CDIP | J | 20 | 1 | Non-RoHS & Green | SNPB | N / A for Pkg Type | -55 to 125 | 8415201RA SNJ54LS684J | Samples |
| SNJ54LS688FK | ACTIVE | LCCC | FK | 20 | 1 | Non-RoHS & Green | SNPB | N / A for Pkg Type | -55 to 125 | 84153012A SNJ54LS 688FK | Samples |
| SNJ54LS688J | ACTIVE | CDIP | J | 20 | 1 | Non-RoHS & Green | SNPB | N / A for Pkg Type | -55 to 125 | 8415301RA SNJ54LS688J | Samples |
| SNJ54LS688W | ACTIVE | CFP | W | 20 | 1 | Non-RoHS & Green | SNPB | N / A for Pkg Type | -55 to 125 | 8415301SA SNJ54LS688W | Samples |

(1) The marketing status values are defined as follows:

ACTIVE: Product device recommended for new designs.

LIFEBUY: TI has announced that the device will be discontinued, and a lifetime-buy period is in effect.

NRND: Not recommended for new designs. Device is in production to support existing customers, but TI does not recommend using this part in a new design.

PREVIEW: Device has been announced but is not in production. Samples may or may not be available.

OBSELETE: TI has discontinued the production of the device.

(2) **RoHS:** TI defines "RoHS" to mean semiconductor products that are compliant with the current EU RoHS requirements for all 10 RoHS substances, including the requirement that RoHS substance do not exceed 0.1% by weight in homogeneous materials. Where designed to be soldered at high temperatures, "RoHS" products are suitable for use in specified lead-free processes. TI may reference these types of products as "Pb-Free".

RoHS Exempt: TI defines "RoHS Exempt" to mean products that contain lead but are compliant with EU RoHS pursuant to a specific EU RoHS exemption.

Green: TI defines "Green" to mean the content of Chlorine (Cl) and Bromine (Br) based flame retardants meet JS709B low halogen requirements of <=1000ppm threshold. Antimony trioxide based flame retardants must also meet the <=1000ppm threshold requirement.

(3) MSL, Peak Temp. - The Moisture Sensitivity Level rating according to the JEDEC industry standard classifications, and peak solder temperature.

(4) There may be additional marking, which relates to the logo, the lot trace code information, or the environmental category on the device.

(5) Multiple Device Markings will be inside parentheses. Only one Device Marking contained in parentheses and separated by a "~" will appear on a device. If a line is indented then it is a continuation of the previous line and the two combined represent the entire Device Marking for that device.

(6) Lead finish/Ball material - Orderable Devices may have multiple material finish options. Finish options are separated by a vertical ruled line. Lead finish/Ball material values may wrap to two lines if the finish value exceeds the maximum column width.

Important Information and Disclaimer:The information provided on this page represents TI's knowledge and belief as of the date that it is provided. TI bases its knowledge and belief on information provided by third parties, and makes no representation or warranty as to the accuracy of such information. Efforts are underway to better integrate information from third parties. TI has taken and

continues to take reasonable steps to provide representative and accurate information but may not have conducted destructive testing or chemical analysis on incoming materials and chemicals. TI and TI suppliers consider certain information to be proprietary, and thus CAS numbers and other limited information may not be available for release.

In no event shall TI's liability arising out of such information exceed the total purchase price of the TI part(s) at issue in this document sold by TI to Customer on an annual basis.

OTHER QUALIFIED VERSIONS OF SN54LS682, SN54LS684, SN54LS688, SN74LS682, SN74LS684, SN74LS688 :

- Catalog : [SN74LS682](#), [SN74LS684](#), [SN74LS688](#)
- Military : [SN54LS682](#), [SN54LS684](#), [SN54LS688](#)

NOTE: Qualified Version Definitions:

- Catalog - TI's standard catalog product
- Military - QML certified for Military and Defense Applications

TAPE AND REEL INFORMATION

QUADRANT ASSIGNMENTS FOR PIN 1 ORIENTATION IN TAPE

*All dimensions are nominal

| Device | Package Type | Package Drawing | Pins | SPQ | Reel Diameter (mm) | Reel Width W1 (mm) | A0 (mm) | B0 (mm) | K0 (mm) | P1 (mm) | W (mm) | Pin1 Quadrant |
|--------------|--------------|-----------------|------|------|--------------------|--------------------|---------|---------|---------|---------|--------|---------------|
| SN74LS682DWR | SOIC | DW | 20 | 2000 | 330.0 | 24.4 | 10.8 | 13.3 | 2.7 | 12.0 | 24.0 | Q1 |
| SN74LS682NSR | SO | NS | 20 | 2000 | 330.0 | 24.4 | 8.4 | 13.0 | 2.5 | 12.0 | 24.0 | Q1 |
| SN74LS684DWR | SOIC | DW | 20 | 2000 | 330.0 | 24.4 | 10.8 | 13.3 | 2.7 | 12.0 | 24.0 | Q1 |
| SN74LS684NSR | SO | NS | 20 | 2000 | 330.0 | 24.4 | 8.4 | 13.0 | 2.5 | 12.0 | 24.0 | Q1 |
| SN74LS688DWR | SOIC | DW | 20 | 2000 | 330.0 | 24.4 | 10.8 | 13.3 | 2.7 | 12.0 | 24.0 | Q1 |
| SN74LS688NSR | SO | NS | 20 | 2000 | 330.0 | 24.4 | 8.4 | 13.0 | 2.5 | 12.0 | 24.0 | Q1 |

TAPE AND REEL BOX DIMENSIONS

*All dimensions are nominal

| Device | Package Type | Package Drawing | Pins | SPQ | Length (mm) | Width (mm) | Height (mm) |
|--------------|--------------|-----------------|------|------|-------------|------------|-------------|
| SN74LS682DWR | SOIC | DW | 20 | 2000 | 367.0 | 367.0 | 45.0 |
| SN74LS682NSR | SO | NS | 20 | 2000 | 367.0 | 367.0 | 45.0 |
| SN74LS684DWR | SOIC | DW | 20 | 2000 | 367.0 | 367.0 | 45.0 |
| SN74LS684NSR | SO | NS | 20 | 2000 | 367.0 | 367.0 | 45.0 |
| SN74LS688DWR | SOIC | DW | 20 | 2000 | 367.0 | 367.0 | 45.0 |
| SN74LS688NSR | SO | NS | 20 | 2000 | 367.0 | 367.0 | 45.0 |

TUBE

*All dimensions are nominal

| Device | Package Name | Package Type | Pins | SPQ | L (mm) | W (mm) | T (μm) | B (mm) |
|--------------|--------------|--------------|------|-----|--------|--------|--------|--------|
| 8415101SA | W | CFP | 20 | 1 | 506.98 | 26.16 | 6220 | NA |
| 84152012A | FK | LCCC | 20 | 1 | 506.98 | 12.06 | 2030 | NA |
| 84153012A | FK | LCCC | 20 | 1 | 506.98 | 12.06 | 2030 | NA |
| 8415301SA | W | CFP | 20 | 1 | 506.98 | 26.16 | 6220 | NA |
| SN74LS682DW | DW | SOIC | 20 | 25 | 507 | 12.83 | 5080 | 6.6 |
| SN74LS682N | N | PDIP | 20 | 20 | 506 | 13.97 | 11230 | 4.32 |
| SN74LS684N | N | PDIP | 20 | 20 | 506 | 13.97 | 11230 | 4.32 |
| SN74LS688DW | DW | SOIC | 20 | 25 | 507 | 12.83 | 5080 | 6.6 |
| SN74LS688N | N | PDIP | 20 | 20 | 506 | 13.97 | 11230 | 4.32 |
| SN74LS688NE4 | N | PDIP | 20 | 20 | 506 | 13.97 | 11230 | 4.32 |
| SNJ54LS682W | W | CFP | 20 | 1 | 506.98 | 26.16 | 6220 | NA |
| SNJ54LS684FK | FK | LCCC | 20 | 1 | 506.98 | 12.06 | 2030 | NA |
| SNJ54LS688FK | FK | LCCC | 20 | 1 | 506.98 | 12.06 | 2030 | NA |
| SNJ54LS688W | W | CFP | 20 | 1 | 506.98 | 26.16 | 6220 | NA |

FK (S-CQCC-N**)

LEADLESS CERAMIC CHIP CARRIER

28 TERMINAL SHOWN



| NO. OF TERMINALS ** | A | | B | |
|---------------------|------------------|------------------|------------------|------------------|
| | MIN | MAX | MIN | MAX |
| 20 | 0.342 (8,69) | 0.358 (9,09) | 0.307 (7,80) | 0.358 (9,09) |
| 28 | 0.442 (11,23) | 0.458 (11,63) | 0.406 (10,31) | 0.458 (11,63) |
| 44 | 0.640 (16,26) | 0.660 (16,76) | 0.495 (12,58) | 0.560 (14,22) |
| 52 | 0.740 (18,78) | 0.761 (19,32) | 0.495 (12,58) | 0.560 (14,22) |
| 68 | 0.938 (23,83) | 0.962 (24,43) | 0.850 (21,6) | 0.858 (21,8) |
| 84 | 1.141 (28,99) | 1.165 (29,59) | 1.047 (26,6) | 1.063 (27,0) |



4040140/D 01/11

- NOTES:
- All linear dimensions are in inches (millimeters).
 - This drawing is subject to change without notice.
 - This package can be hermetically sealed with a metal lid.
 - Falls within JEDEC MS-004

MECHANICAL DATA

NS (R-PDSO-G**)

PLASTIC SMALL-OUTLINE PACKAGE

14-PINS SHOWN



- NOTES:
- A. All linear dimensions are in millimeters.
 - B. This drawing is subject to change without notice.
 - C. Body dimensions do not include mold flash or protrusion, not to exceed 0,15.

J (R-GDIP-T**)

14 LEADS SHOWN

CERAMIC DUAL IN-LINE PACKAGE



| DIM \ PINS ** | 14 | 16 | 18 | 20 |
|---------------|------------------------|------------------------|------------------------|------------------------|
| A | 0.300 (7,62) BSC | 0.300 (7,62) BSC | 0.300 (7,62) BSC | 0.300 (7,62) BSC |
| B MAX | 0.785 (19,94) | .840 (21,34) | 0.960 (24,38) | 1.060 (26,92) |
| B MIN | — | — | — | — |
| C MAX | 0.300 (7,62) | 0.300 (7,62) | 0.310 (7,87) | 0.300 (7,62) |
| C MIN | 0.245 (6,22) | 0.245 (6,22) | 0.220 (5,59) | 0.245 (6,22) |



4040083/F 03/03

- NOTES:
- All linear dimensions are in inches (millimeters).
 - This drawing is subject to change without notice.
 - This package is hermetically sealed with a ceramic lid using glass frit.
 - Index point is provided on cap for terminal identification only on press ceramic glass frit seal only.
 - Falls within MIL STD 1835 GDIP1-T14, GDIP1-T16, GDIP1-T18 and GDIP1-T20.

N (R-PDIP-T**)

PLASTIC DUAL-IN-LINE PACKAGE

16 PINS SHOWN



- NOTES:
- A. All linear dimensions are in inches (millimeters).
 - B. This drawing is subject to change without notice.
 - (C) Falls within JEDEC MS-001, except 18 and 20 pin minimum body length (Dim A).
 - (D) The 20 pin end lead shoulder width is a vendor option, either half or full width.

DW0020A



PACKAGE OUTLINE

SOIC - 2.65 mm max height

SOIC



4220724/A 05/2016

NOTES:

1. All linear dimensions are in millimeters. Dimensions in parenthesis are for reference only. Dimensioning and tolerancing per ASME Y14.5M.
2. This drawing is subject to change without notice.
3. This dimension does not include mold flash, protrusions, or gate burrs. Mold flash, protrusions, or gate burrs shall not exceed 0.15 mm per side.
4. This dimension does not include interlead flash. Interlead flash shall not exceed 0.43 mm per side.
5. Reference JEDEC registration MS-013.

EXAMPLE BOARD LAYOUT

DW0020A

SOIC - 2.65 mm max height

SOIC



LAND PATTERN EXAMPLE
SCALE:6X



SOLDER MASK DETAILS

4220724/A 05/2016

NOTES: (continued)

- 6. Publication IPC-7351 may have alternate designs.
- 7. Solder mask tolerances between and around signal pads can vary based on board fabrication site.

EXAMPLE STENCIL DESIGN

DW0020A

SOIC - 2.65 mm max height

SOIC



SOLDER PASTE EXAMPLE
BASED ON 0.125 mm THICK STENCIL
SCALE:6X

4220724/A 05/2016

NOTES: (continued)

8. Laser cutting apertures with trapezoidal walls and rounded corners may offer better paste release. IPC-7525 may have alternate design recommendations.
9. Board assembly site may have different recommendations for stencil design.

W (R-GDFP-F20)

CERAMIC DUAL FLATPACK



- NOTES:
- A. All linear dimensions are in inches (millimeters).
 - B. This drawing is subject to change without notice.
 - C. This package can be hermetically sealed with a ceramic lid using glass frit.
 - D. Index point is provided on cap for terminal identification only.
 - E. Falls within Mil-Std 1835 GDFP2-F20

IMPORTANT NOTICE AND DISCLAIMER

TI PROVIDES TECHNICAL AND RELIABILITY DATA (INCLUDING DATA SHEETS), DESIGN RESOURCES (INCLUDING REFERENCE DESIGNS), APPLICATION OR OTHER DESIGN ADVICE, WEB TOOLS, SAFETY INFORMATION, AND OTHER RESOURCES "AS IS" AND WITH ALL FAULTS, AND DISCLAIMS ALL WARRANTIES, EXPRESS AND IMPLIED, INCLUDING WITHOUT LIMITATION ANY IMPLIED WARRANTIES OF MERCHANTABILITY, FITNESS FOR A PARTICULAR PURPOSE OR NON-INFRINGEMENT OF THIRD PARTY INTELLECTUAL PROPERTY RIGHTS.

These resources are intended for skilled developers designing with TI products. You are solely responsible for (1) selecting the appropriate TI products for your application, (2) designing, validating and testing your application, and (3) ensuring your application meets applicable standards, and any other safety, security, regulatory or other requirements.

These resources are subject to change without notice. TI grants you permission to use these resources only for development of an application that uses the TI products described in the resource. Other reproduction and display of these resources is prohibited. No license is granted to any other TI intellectual property right or to any third party intellectual property right. TI disclaims responsibility for, and you will fully indemnify TI and its representatives against, any claims, damages, costs, losses, and liabilities arising out of your use of these resources.

TI's products are provided subject to [TI's Terms of Sale](#) or other applicable terms available either on ti.com or provided in conjunction with such TI products. TI's provision of these resources does not expand or otherwise alter TI's applicable warranties or warranty disclaimers for TI products.

TI objects to and rejects any additional or different terms you may have proposed.

Mailing Address: Texas Instruments, Post Office Box 655303, Dallas, Texas 75265
Copyright © 2022, Texas Instruments Incorporated