

## SNx4AHCT14 Hex Schmitt-Trigger Inverters

### 1 Features

- Inputs are TTL-Voltage Compatible
- Latch-Up Performance Exceeds 250 mA Per JESD 17
- ESD Protection Exceeds JESD 22
  - 2000-V Human-Body Model (A114-A)
  - 200-V Machine Model (A115-A)
  - 1000-V Charged-Device Model (C101)
- On Products Compliant to MIL-PRF-38535, All Parameters Are Tested Unless Otherwise Noted. On All Other Products, Production Processing Does Not Necessarily Include Testing of All Parameters.

### 2 Applications

- Servers
- Network Switches
- Telecom Infrastructures
- Tests and Measurements

### 4 Simplified Schematic

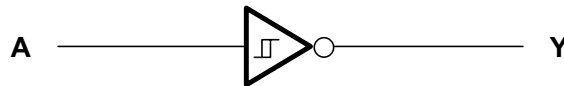

### 3 Description

The SNx4AHCT14 devices contain six independent inverters. These devices perform the Boolean function  $Y = \bar{A}$ .

#### Device Information<sup>(1)</sup>

PART NUMBER	PACKAGE	BODY SIZE (NOM)
SNxAHCT14	VQFN (14)	3.50 mm x 3.50 mm
	TSSOP (14)	5.00 mm x 4.40 mm
	SSOP (14)	6.20 mm x 5.30 mm
	TVSOP (14)	3.60 mm x 4.40 mm
	SOIC (14)	8.65 mm x 3.91 mm

(1) For all available packages, see the orderable addendum at the end of the data sheet.



## Table of Contents

<b>1 Features</b> .....	<b>1</b>	9.1 Overview .....	<b>8</b>
<b>2 Applications</b> .....	<b>1</b>	9.2 Functional Block Diagram .....	<b>8</b>
<b>3 Description</b> .....	<b>1</b>	9.3 Feature Description .....	<b>8</b>
<b>4 Simplified Schematic</b> .....	<b>1</b>	9.4 Device Functional Modes .....	<b>8</b>
<b>5 Revision History</b> .....	<b>2</b>	<b>10 Application and Implementation</b> .....	<b>9</b>
<b>6 Pin Configuration and Functions</b> .....	<b>3</b>	10.1 Application Information .....	<b>9</b>
<b>7 Specifications</b> .....	<b>4</b>	10.2 Typical Application .....	<b>9</b>
7.1 Absolute Maximum Ratings .....	<b>4</b>	<b>11 Power Supply Recommendations</b> .....	<b>11</b>
7.2 Handling Ratings .....	<b>4</b>	<b>12 Layout</b> .....	<b>11</b>
7.3 Recommended Operating Conditions .....	<b>4</b>	12.1 Layout Guidelines .....	<b>11</b>
7.4 Thermal Information .....	<b>5</b>	12.2 Layout Example .....	<b>11</b>
7.5 Electrical Characteristics .....	<b>5</b>	<b>13 Device and Documentation Support</b> .....	<b>12</b>
7.6 Switching Characteristics .....	<b>5</b>	13.1 Related Links .....	<b>12</b>
7.7 Noise Characteristics .....	<b>6</b>	13.2 Trademarks .....	<b>12</b>
7.8 Operating Characteristics .....	<b>6</b>	13.3 Electrostatic Discharge Caution .....	<b>12</b>
7.9 Typical Characteristics .....	<b>6</b>	13.4 Glossary .....	<b>12</b>
<b>8 Parameter Measurement Information</b> .....	<b>7</b>	<b>14 Mechanical, Packaging, and Orderable Information</b> .....	<b>12</b>
<b>9 Detailed Description</b> .....	<b>8</b>		

## 5 Revision History

<b>Changes from Revision P (July 2003) to Revision Q</b>	<b>Page</b>
• Updated document to new TI data sheet standards. ....	<b>1</b>
• Deleted Ordering Information table. ....	<b>1</b>
• Added Military Disclaimer to Features list. ....	<b>1</b>
• Added Pin Functions table .....	<b>3</b>
• Added Handling Ratings table .....	<b>4</b>
• Changed SN74AHCT14 MAX ambient temperature in Recommended Operating Conditions table. ....	<b>4</b>
• Added Thermal Information table .....	<b>5</b>
• Added Typical Characteristics .....	<b>6</b>
• Added Detailed Description section .....	<b>8</b>
• Added Application and Implementation section .....	<b>9</b>
• Added Power Supply Recommendations section .....	<b>11</b>
• Added Layout section .....	<b>11</b>

## 6 Pin Configuration and Functions

**SN54AHCT14 . . . J OR W PACKAGE  
SN74AHCT14 . . . D, DB, DGV, N, NS,  
OR PW PACKAGE  
(TOP VIEW)**

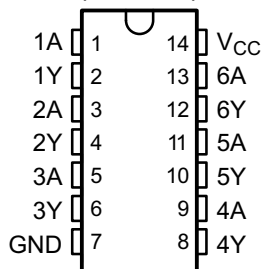

**SN74AHCT14 . . . RGY PACKAGE  
(TOP VIEW)**

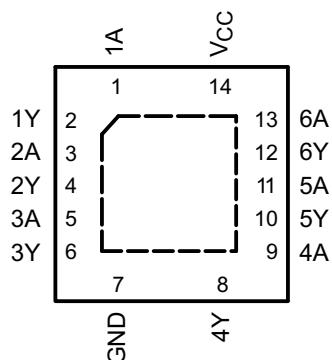

**SN54AHCT14 . . . FK PACKAGE  
(TOP VIEW)**

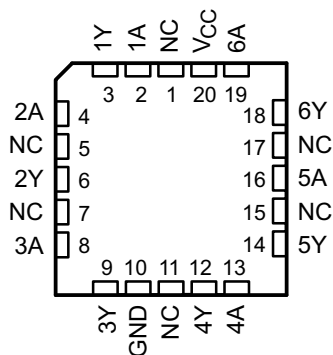

NC – No internal connection

### Pin Functions

PIN		I/O	DESCRIPTION
NO.	NAME		
1	1A	I	1A1
2	1Y	O	1Y1
3	2A	I	2A1
4	2Y	O	2Y1
5	3A	I	3A1
6	3Y	O	3Y1
7	GND	—	Ground pin
8	4Y	O	4Y1
9	4A	I	4A1
10	5Y	O	5Y1
11	5A	I	5A1
12	6Y	O	6Y1
13	6A	I	6A1
14	VCC	—	Power pin

## 7 Specifications

### 7.1 Absolute Maximum Ratings

 over operating free-air temperature range (unless otherwise noted)<sup>(1)</sup>

		MIN	MAX	UNIT
V <sub>CC</sub>	Supply voltage range	–0.5	7	V
V <sub>I</sub>	Input voltage range <sup>(2)</sup>	–0.5	7	V
V <sub>O</sub>	Output voltage range <sup>(2)</sup>	–0.5	V <sub>CC</sub> + 0.5	V
I <sub>IK</sub>	Input clamp current	V <sub>I</sub> < 0		–20
I <sub>OK</sub>	Output clamp current	V <sub>O</sub> < 0 or V <sub>O</sub> > V <sub>CC</sub>		±20
I <sub>O</sub>	Continuous output current	V <sub>O</sub> = 0 to V <sub>CC</sub>		±25
Continuous current through V <sub>CC</sub> or GND				±50

- (1) Stresses beyond those listed under *Absolute Maximum Ratings* may cause permanent damage to the device. These are stress ratings only, which do not imply functional operation of the device at these or any other conditions beyond those indicated under *Recommended Operating Conditions*. Exposure to absolute-maximum-rated conditions for extended periods may affect device reliability.
- (2) The input and output voltage ratings may be exceeded if the input and output current ratings are observed.

### 7.2 Handling Ratings

		MIN	MAX	UNIT
T <sub>stg</sub>	Storage temperature range	–65	150	°C
V <sub>(ESD)</sub>	Electrostatic discharge	Human body model (HBM), per ANSI/ESDA/JEDEC JS-001, all pins <sup>(1)</sup>		V
		Charged device model (CDM), per JEDEC specification JESD22-C101, all pins <sup>(2)</sup>		

- (1) JEDEC document JEP155 states that 500-V HBM allows safe manufacturing with a standard ESD control process.
- (2) JEDEC document JEP157 states that 250-V CDM allows safe manufacturing with a standard ESD control process.

### 7.3 Recommended Operating Conditions

 over operating free-air temperature range (unless otherwise noted)<sup>(1)</sup>

		SN54AHCT14		SN74AHCT14		UNIT
		MIN	MAX	MIN	MAX	
V <sub>CC</sub>	Supply voltage	4.5	5.5	4.5	5.5	V
V <sub>I</sub>	Input voltage	0	5.5	0	5.5	V
V <sub>O</sub>	Output voltage	0	V <sub>CC</sub>	0	V <sub>CC</sub>	V
I <sub>OH</sub>	High-level output current	–8		–8		mA
I <sub>OL</sub>	Low-level output current	8		8		mA
T <sub>A</sub>	Operating free-air temperature	–55	125	–40	125	°C

- (1) All unused inputs of the device must be held at V<sub>CC</sub> or GND to ensure proper device operation. Refer to the TI Application Report, *Implications of Slow or Floating CMOS Inputs*, (SCBA004).

## 7.4 Thermal Information

THERMAL METRIC <sup>(1)</sup>	SN74AHCT595							UNIT	
	D	DGV	DB	N	NS	PW	RGY		
	14 PINS								
R <sub>θJA</sub>	Junction-to-ambient thermal resistance	101.2	138.7	113.1	61.1	98.6	129.9	63.7	°C/W
R <sub>θJC(top)</sub>	Junction-to-case (top) thermal resistance	62.3	60.6	65.6	48.0	54.1	58.3	77.6	
R <sub>θJB</sub>	Junction-to-board thermal resistance	55.5	71.8	60.4	41.0	57.4	71.8	39.7	
Ψ <sub>JT</sub>	Junction-to-top characterization parameter	25.5	10.6	25.5	32.4	19.6	10.2	5.7	
Ψ <sub>JB</sub>	Junction-to-board characterization parameter	55.2	71.1	59.9	40.9	57.0	71.2	39.9	
R <sub>θJC(bot)</sub>	Junction-to-case (bottom) thermal resistance	n/a	n/a	n/a	n/a	n/a	n/a	19.9	

(1) For more information about traditional and new thermal metrics, see the *IC Package Thermal Metrics* application report, (SPRA953).

## 7.5 Electrical Characteristics

over operating free-air temperature range (unless otherwise noted)

PARAMETER	TEST CONDITIONS	V <sub>CC</sub>	T <sub>A</sub> = 25°C			SN54AHCT14		SN74AHCT14		UNIT
			MIN	TYP	MAX	MIN	MAX	MIN	MAX	
V <sub>T+</sub> Positive-going input threshold voltage		4.5 V	0.9		1.9	0.9	1.9	0.9	1.9	V
		5.5 V	1		2.1	1	2.1	1	2.1	
V <sub>T-</sub> Negative-going input threshold voltage		4.5 V	0.5		1.5	0.5	1.5	0.5	1.5	V
		5.5 V	0.6		1.7	0.6	1.7	0.6	1.7	
ΔV <sub>T</sub> Hysteresis (V <sub>T+</sub> – V <sub>T-</sub> )		4.5 V	0.4		1.4	0.4	1.4	0.4	1.4	V
		5.5 V	0.4		1.5	0.4	1.5	0.4	1.5	
V <sub>OH</sub>	I <sub>OH</sub> = –50 μA	4.5 V	4.4	4.5		4.4		4.4		V
	I <sub>OH</sub> = –8 mA		3.94			3.8		3.8		
V <sub>OL</sub>	I <sub>OL</sub> = 50 μA	4.5 V			0.1		0.1		0.1	V
	I <sub>OL</sub> = 8 mA				0.36		0.44		0.44	
I <sub>I</sub>	V <sub>I</sub> = 5.5 V or GND	0 V to 5.5 V			±0.1		±1 <sup>(1)</sup>		±1	μA
I <sub>CC</sub>	V <sub>I</sub> = V <sub>CC</sub> or GND I <sub>O</sub> = 0	5.5 V			2		20		20	μA
ΔI <sub>CC</sub> <sup>(2)</sup>	One input at 3.4 V, Other inputs at V <sub>CC</sub> or GND	5.5 V			1.35		1.5		1.5	mA
C <sub>i</sub>	V <sub>I</sub> = V <sub>CC</sub> or GND	5 V			2	10			10	pF

(1) On products compliant to MIL-PRF-38535, this parameter is not production tested at V<sub>CC</sub> = 0 V.

(2) This is the increase in supply current for each input at one of the specified TTL voltage levels, rather than 0 V or V<sub>CC</sub>.

## 7.6 Switching Characteristics

over operating free-air temperature range (unless otherwise noted)

PARAMETER	FROM (INPUT)	TO (OUTPUT)	LOAD CAPACITANCE	T <sub>A</sub> = 25°C			SN54AHCT14		SN74AHCT14		UNIT
				MIN	TYP	MAX	MIN	MAX	MIN	MAX	
t <sub>PLH</sub>	A	Y	C <sub>L</sub> = 15 pF		4 <sup>(1)</sup>	7 <sup>(1)</sup>	1 <sup>(1)</sup>	8 <sup>(1)</sup>	1	8	ns
t <sub>PHL</sub>					4 <sup>(1)</sup>	7 <sup>(1)</sup>	1 <sup>(1)</sup>	8 <sup>(1)</sup>	1	8	
t <sub>PLH</sub>	A	Y	C <sub>L</sub> = 50 pF		5.5	8	1	9	1	9	ns
t <sub>PHL</sub>					5.5	8	1	9	1	9	

(1) On products compliant to MIL-PRF-38535, this parameter is not production tested.

## 7.7 Noise Characteristics

 $V_{CC} = 5\text{ V}$ ,  $C_L = 50\text{ pF}$ ,  $T_A = 25^\circ\text{C}^{(1)}$ 

PARAMETER		SN74AHCT14			UNIT
		MIN	TYP	MAX	
$V_{OL(P)}$	Quiet output, maximum dynamic $V_{OL}$		0.9		V
$V_{OL(V)}$	Quiet output, minimum dynamic $V_{OL}$		-0.7		V
$V_{OH(V)}$	Quiet output, minimum dynamic $V_{OH}$		4.3		V
$V_{IH(D)}$	High-level dynamic input voltage	2.1			V
$V_{IL(D)}$	Low-level dynamic input voltage			0.5	V

(1) Characteristics are for surface-mount packages only.

## 7.8 Operating Characteristics

 $V_{CC} = 5\text{ V}$ ,  $T_A = 25^\circ\text{C}$ 

PARAMETER	TEST CONDITIONS	TYP	UNIT
$C_{pd}$	No load, $f = 1\text{ MHz}$	112	pF

## 7.9 Typical Characteristics

One common misconception is that the current consumption will be less when switching a slow signal into a Schmitt trigger. This is partly true because the Schmitt trigger prevents oscillation which can draw a lot of current; however, you will see higher  $I_{CC}$  current due to the amount of time the input is not at the rail. This is  $\Delta I_{CC}$ .  $\Delta I_{CC}$  is where the inputs are not at the rails and upper or lower drive transistors are partially on. [Figure 1](#) shows  $I_{CC}$  across the input voltage sweep.

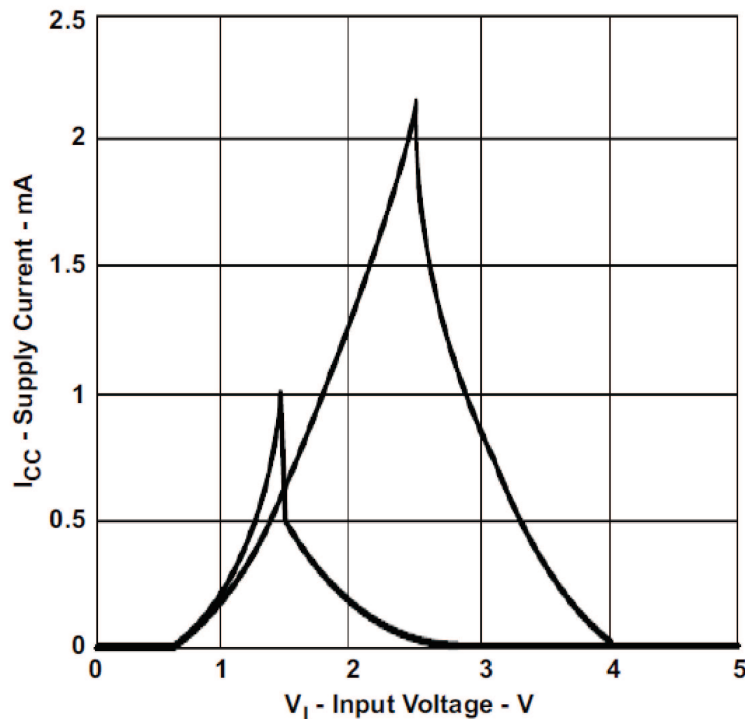
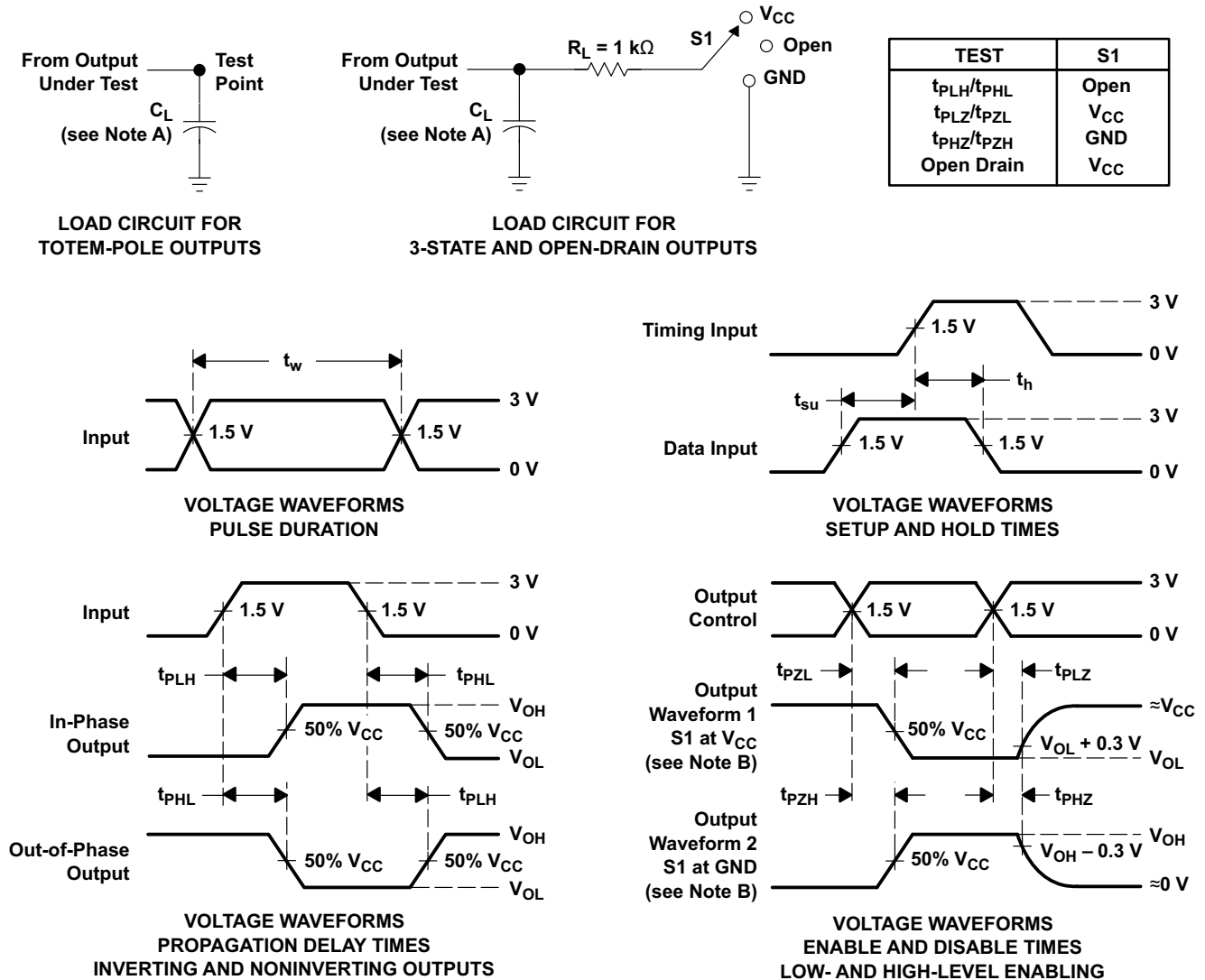

Figure 1. Supply Current vs Input Voltage

## 8 Parameter Measurement Information



- NOTES:
- A.  $C_L$  includes probe and jig capacitance.
  - B. Waveform 1 is for an output with internal conditions such that the output is low except when disabled by the output control. Waveform 2 is for an output with internal conditions such that the output is high except when disabled by the output control.
  - C. All input pulses are supplied by generators having the following characteristics:  $PRR \leq 1$  MHz,  $Z_O = 50 \Omega$ ,  $t_r \leq 3$  ns,  $t_f \leq 3$  ns.
  - D. The outputs are measured one at a time with one input transition per measurement.
  - E. All parameters and waveforms are not applicable to all devices.

Figure 2. Load Circuit and Voltage Waveforms

## 9 Detailed Description

### 9.1 Overview

The SNx4AHCT14 devices contain six independent inverters. These devices perform the Boolean function  $Y = \bar{A}$ . Each circuit functions as an independent inverter, but because of the Schmitt action, the inverters have different input threshold levels for positive-going ( $V_{T+}$ ) and for negative-going ( $V_{T-}$ ) signals.

### 9.2 Functional Block Diagram

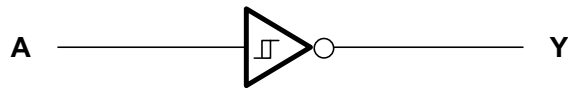

### 9.3 Feature Description

- Inputs are TTL-Voltage compatible
- Inputs accept very slow or noisy inputs

### 9.4 Device Functional Modes

**Table 1. Function Table  
(Each Inverter)**

INPUT A	OUTPUT Y
H	L
L	H



## 10 Application and Implementation

### 10.1 Application Information

Schmitt triggers should be used anytime you need to translate a sign wave into a square wave, or used where a slow or noisy input needs to be sped up or cleaned up as in the switch de-bouncer circuit.

### 10.2 Typical Application

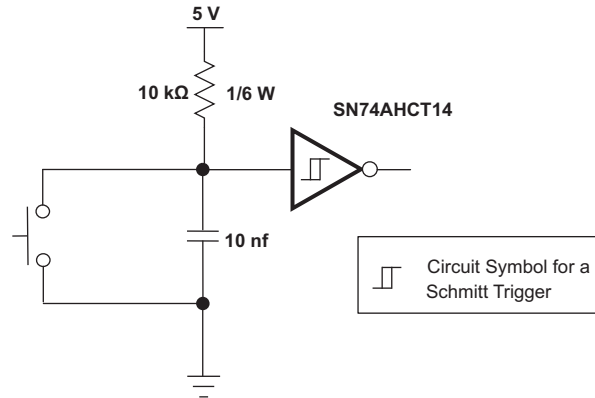

Figure 3. Switch De-bouncer Using Schmitt Trigger Inverter

#### 10.2.1 Design Requirements

This device uses CMOS technology and has balanced output drive. Care should be taken to avoid bus contention because it can drive currents that would exceed maximum limits. The high drive will also create fast edges into light loads; therefore, routing and load conditions should be considered to prevent ringing.

#### 10.2.2 Detailed Design Procedure

1. Recommended input conditions
  - Rise time and fall time specs: See  $(\Delta t/\Delta V)$  in the [Recommended Operating Conditions](#) table.
  - Specified High and low levels: See  $(V_{IH}$  and  $V_{IL})$  in the [Recommended Operating Conditions](#) table.
  - Inputs are overvoltage tolerant allowing them to go as high as 5.5 V at any valid  $V_{CC}$
2. Recommend output conditions
  - Load currents should not exceed 25 mA per output and 50 mA total for the part
  - Outputs should not be pulled above  $V_{CC}$

**Typical Application (continued)**
**10.2.3 Application Curves**

Schmitt triggers should be used any time you need to

1. Change a sign wave into a square wave.

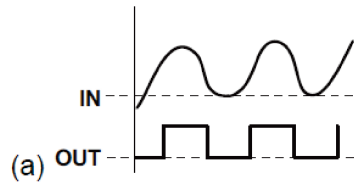

2. Have noisy signals that need to be cleaned up

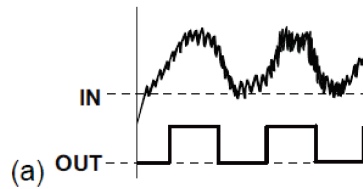

3. Have slow edges that need to be converted to fast edges.

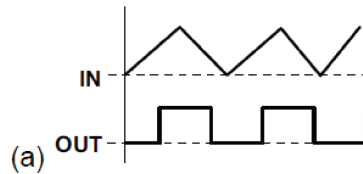

**Figure 4. Typical Application Curves**

## 11 Power Supply Recommendations

The power supply can be any voltage between the MIN and MAX supply voltage rating located in the [Recommended Operating Conditions](#) table.

Each VCC pin should have a good bypass capacitor to prevent power disturbance. For devices with a single supply, 0.1  $\mu\text{f}$  is recommended. If there are multiple VCC pins, 0.01  $\mu\text{f}$  or 0.022  $\mu\text{f}$  is recommended for each power pin. It is acceptable to parallel multiple bypass caps to reject different frequencies of noise. A 0.1  $\mu\text{f}$  and 1  $\mu\text{f}$  are commonly used in parallel. The bypass capacitor should be installed as close to the power pin as possible for best results.

## 12 Layout

### 12.1 Layout Guidelines

When using multiple bit logic devices inputs should not ever float.

In many cases, functions or parts of functions of digital logic devices are unused, for example, when only two inputs of a triple-input AND gate are used or only 3 of the 4 buffer gates are used. Such input pins should not be left unconnected because the undefined voltages at the outside connections result in undefined operational states. Specified in [Figure 5](#) are the rules that must be observed under all circumstances. All unused inputs of digital logic devices must be connected to a high or low bias to prevent them from floating. The logic level that should be applied to any particular unused input depends on the function of the device. Generally they will be tied to GND or VCC; whichever makes more sense or is more convenient. It is generally acceptable to float outputs unless the part is a transceiver. If the transceiver has an output enable pin, it will disable the outputs section of the part when asserted. This will not disable the input section of the IO's so they cannot float when disabled.

### 12.2 Layout Example

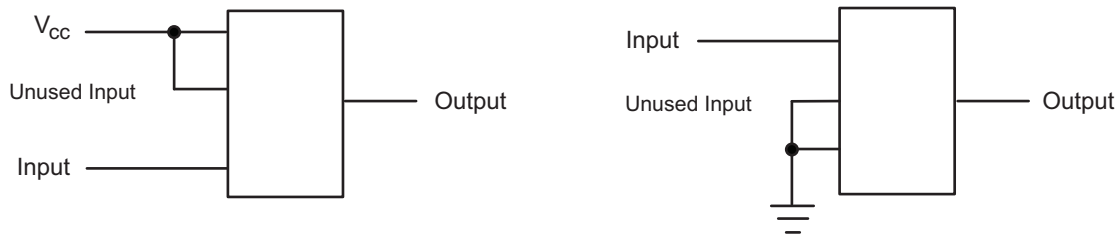

**Figure 5. Layout Diagram**

## 13 Device and Documentation Support

### 13.1 Related Links

The table below lists quick access links. Categories include technical documents, support and community resources, tools and software, and quick access to sample or buy.

**Table 2. Related Links**

PARTS	PRODUCT FOLDER	SAMPLE & BUY	TECHNICAL DOCUMENTS	TOOLS & SOFTWARE	SUPPORT & COMMUNITY
SN54AHCT14	<a href="#">Click here</a>	<a href="#">Click here</a>	<a href="#">Click here</a>	<a href="#">Click here</a>	<a href="#">Click here</a>
SN74AHCT14	<a href="#">Click here</a>	<a href="#">Click here</a>	<a href="#">Click here</a>	<a href="#">Click here</a>	<a href="#">Click here</a>

### 13.2 Trademarks

### 13.3 Electrostatic Discharge Caution



These devices have limited built-in ESD protection. The leads should be shorted together or the device placed in conductive foam during storage or handling to prevent electrostatic damage to the MOS gates.

### 13.4 Glossary

[SLYZ022](#) — *TI Glossary*.

This glossary lists and explains terms, acronyms, and definitions.

## 14 Mechanical, Packaging, and Orderable Information

The following pages include mechanical, packaging, and orderable information. This information is the most current data available for the designated devices. This data is subject to change without notice and revision of this document. For browser-based versions of this data sheet, refer to the left-hand navigation.

**PACKAGING INFORMATION**

Orderable Device	Status (1)	Package Type	Package Drawing	Pins	Package Qty	Eco Plan (2)	Lead finish/ Ball material (6)	MSL Peak Temp (3)	Op Temp (°C)	Device Marking (4/5)	Samples
5962-9680101Q2A	ACTIVE	LCCC	FK	20	1	Non-RoHS & Green	SNPB	N / A for Pkg Type	-55 to 125	5962-9680101Q2A SNJ54AHCT 14FK	<a href="#">Samples</a>
5962-9680101QCA	ACTIVE	CDIP	J	14	1	Non-RoHS & Green	SNPB	N / A for Pkg Type	-55 to 125	5962-9680101QC A SNJ54AHCT14J	<a href="#">Samples</a>
5962-9680101QDA	ACTIVE	CFP	W	14	1	Non-RoHS & Green	SNPB	N / A for Pkg Type	-55 to 125	5962-9680101QD A SNJ54AHCT14W	<a href="#">Samples</a>
5962-9680101VCA	ACTIVE	CDIP	J	14	1	Non-RoHS & Green	SNPB	N / A for Pkg Type	-55 to 125	5962-9680101VC A SNV54AHCT14J	<a href="#">Samples</a>
5962-9680101VDA	ACTIVE	CFP	W	14	1	Non-RoHS & Green	SNPB	N / A for Pkg Type	-55 to 125	5962-9680101VD A SNV54AHCT14W	<a href="#">Samples</a>
SN74AHCT14D	ACTIVE	SOIC	D	14	50	RoHS & Green	NIPDAU	Level-1-260C-UNLIM	-40 to 125	AHCT14	<a href="#">Samples</a>
SN74AHCT14DBR	ACTIVE	SSOP	DB	14	2000	RoHS & Green	NIPDAU	Level-1-260C-UNLIM	-40 to 125	HB14	<a href="#">Samples</a>
SN74AHCT14DG4	ACTIVE	SOIC	D	14	50	RoHS & Green	NIPDAU	Level-1-260C-UNLIM	-40 to 125	AHCT14	<a href="#">Samples</a>
SN74AHCT14DGVR	ACTIVE	TVSOP	DGV	14	2000	RoHS & Green	NIPDAU	Level-1-260C-UNLIM	-40 to 85	HB14	<a href="#">Samples</a>
SN74AHCT14DGVRE4	ACTIVE	TVSOP	DGV	14	2000	RoHS & Green	NIPDAU	Level-1-260C-UNLIM	-40 to 125	HB14	<a href="#">Samples</a>
SN74AHCT14DR	ACTIVE	SOIC	D	14	2500	RoHS & Green	NIPDAU	Level-1-260C-UNLIM	-40 to 125	AHCT14	<a href="#">Samples</a>
SN74AHCT14DRG4	ACTIVE	SOIC	D	14	2500	RoHS & Green	NIPDAU	Level-1-260C-UNLIM	-40 to 125	AHCT14	<a href="#">Samples</a>
SN74AHCT14N	ACTIVE	PDIP	N	14	25	RoHS & Green	NIPDAU	N / A for Pkg Type	-40 to 125	SN74AHCT14N	<a href="#">Samples</a>
SN74AHCT14NSR	ACTIVE	SO	NS	14	2000	RoHS & Green	NIPDAU	Level-1-260C-UNLIM	-40 to 125	AHCT14	<a href="#">Samples</a>
SN74AHCT14PW	ACTIVE	TSSOP	PW	14	90	RoHS & Green	NIPDAU	Level-1-260C-UNLIM	-40 to 125	HB14	<a href="#">Samples</a>
SN74AHCT14PWE4	ACTIVE	TSSOP	PW	14	90	TBD	Call TI	Call TI	-40 to 125		<a href="#">Samples</a>

Orderable Device	Status (1)	Package Type	Package Drawing	Pins	Package Qty	Eco Plan (2)	Lead finish/ Ball material (6)	MSL Peak Temp (3)	Op Temp (°C)	Device Marking (4/5)	Samples
SN74AHCT14PWR	ACTIVE	TSSOP	PW	14	2000	RoHS & Green	NIPDAU	Level-1-260C-UNLIM	-40 to 125	HB14	<a href="#">Samples</a>
SN74AHCT14PWRE4	ACTIVE	TSSOP	PW	14	2000	RoHS & Green	NIPDAU	Level-1-260C-UNLIM	-40 to 125	HB14	<a href="#">Samples</a>
SN74AHCT14RGYR	ACTIVE	VQFN	RGY	14	3000	RoHS & Green	NIPDAU	Level-2-260C-1 YEAR	-40 to 125	HB14	<a href="#">Samples</a>
SNJ54AHCT14FK	ACTIVE	LCCC	FK	20	1	Non-RoHS & Green	SNPB	N / A for Pkg Type	-55 to 125	5962-9680101Q2A SNJ54AHCT14FK	<a href="#">Samples</a>
SNJ54AHCT14J	ACTIVE	CDIP	J	14	1	Non-RoHS & Green	SNPB	N / A for Pkg Type	-55 to 125	5962-9680101QC A SNJ54AHCT14J	<a href="#">Samples</a>
SNJ54AHCT14W	ACTIVE	CFP	W	14	1	Non-RoHS & Green	SNPB	N / A for Pkg Type	-55 to 125	5962-9680101QD A SNJ54AHCT14W	<a href="#">Samples</a>

(1) The marketing status values are defined as follows:

**ACTIVE:** Product device recommended for new designs.

**LIFEBUY:** TI has announced that the device will be discontinued, and a lifetime-buy period is in effect.

**NRND:** Not recommended for new designs. Device is in production to support existing customers, but TI does not recommend using this part in a new design.

**PREVIEW:** Device has been announced but is not in production. Samples may or may not be available.

**OBSOLETE:** TI has discontinued the production of the device.

(2) **RoHS:** TI defines "RoHS" to mean semiconductor products that are compliant with the current EU RoHS requirements for all 10 RoHS substances, including the requirement that RoHS substance do not exceed 0.1% by weight in homogeneous materials. Where designed to be soldered at high temperatures, "RoHS" products are suitable for use in specified lead-free processes. TI may reference these types of products as "Pb-Free".

**RoHS Exempt:** TI defines "RoHS Exempt" to mean products that contain lead but are compliant with EU RoHS pursuant to a specific EU RoHS exemption.

**Green:** TI defines "Green" to mean the content of Chlorine (Cl) and Bromine (Br) based flame retardants meet JS709B low halogen requirements of <=1000ppm threshold. Antimony trioxide based flame retardants must also meet the <=1000ppm threshold requirement.

(3) MSL, Peak Temp. - The Moisture Sensitivity Level rating according to the JEDEC industry standard classifications, and peak solder temperature.

(4) There may be additional marking, which relates to the logo, the lot trace code information, or the environmental category on the device.

(5) Multiple Device Markings will be inside parentheses. Only one Device Marking contained in parentheses and separated by a "~" will appear on a device. If a line is indented then it is a continuation of the previous line and the two combined represent the entire Device Marking for that device.

(6) Lead finish/Ball material - Orderable Devices may have multiple material finish options. Finish options are separated by a vertical ruled line. Lead finish/Ball material values may wrap to two lines if the finish value exceeds the maximum column width.

**Important Information and Disclaimer:**The information provided on this page represents TI's knowledge and belief as of the date that it is provided. TI bases its knowledge and belief on information provided by third parties, and makes no representation or warranty as to the accuracy of such information. Efforts are underway to better integrate information from third parties. TI has taken and continues to take reasonable steps to provide representative and accurate information but may not have conducted destructive testing or chemical analysis on incoming materials and chemicals. TI and TI suppliers consider certain information to be proprietary, and thus CAS numbers and other limited information may not be available for release.

In no event shall TI's liability arising out of such information exceed the total purchase price of the TI part(s) at issue in this document sold by TI to Customer on an annual basis.

**OTHER QUALIFIED VERSIONS OF SN54AHCT14, SN54AHCT14-SP, SN74AHCT14 :**

- Catalog : [SN74AHCT14](#), [SN54AHCT14](#)
  
- Enhanced Product : [SN74AHCT14-EP](#), [SN74AHCT14-EP](#)
  
- Military : [SN54AHCT14](#)
  
- Space : [SN54AHCT14-SP](#)

NOTE: Qualified Version Definitions:

- Catalog - TI's standard catalog product
  
- Enhanced Product - Supports Defense, Aerospace and Medical Applications
  
- Military - QML certified for Military and Defense Applications
  
- Space - Radiation tolerant, ceramic packaging and qualified for use in Space-based application

**TAPE AND REEL INFORMATION**

**QUADRANT ASSIGNMENTS FOR PIN 1 ORIENTATION IN TAPE**

\*All dimensions are nominal

Device	Package Type	Package Drawing	Pins	SPQ	Reel Diameter (mm)	Reel Width W1 (mm)	A0 (mm)	B0 (mm)	K0 (mm)	P1 (mm)	W (mm)	Pin1 Quadrant
SN74AHCT14DBR	SSOP	DB	14	2000	330.0	16.4	8.35	6.6	2.4	12.0	16.0	Q1
SN74AHCT14DGVR	TVSOP	DGV	14	2000	330.0	12.4	6.8	4.0	1.6	8.0	12.0	Q1
SN74AHCT14DR	SOIC	D	14	2500	330.0	16.4	6.5	9.0	2.1	8.0	16.0	Q1
SN74AHCT14NSR	SO	NS	14	2000	330.0	16.4	8.2	10.5	2.5	12.0	16.0	Q1
SN74AHCT14PWR	TSSOP	PW	14	2000	330.0	12.4	6.9	5.6	1.6	8.0	12.0	Q1
SN74AHCT14RGYR	VQFN	RGY	14	3000	330.0	12.4	3.75	3.75	1.15	8.0	12.0	Q1



**TAPE AND REEL BOX DIMENSIONS**

\*All dimensions are nominal

Device	Package Type	Package Drawing	Pins	SPQ	Length (mm)	Width (mm)	Height (mm)
SN74AHCT14DBR	SSOP	DB	14	2000	356.0	356.0	35.0
SN74AHCT14DGVR	TVSOP	DGV	14	2000	356.0	356.0	35.0
SN74AHCT14DR	SOIC	D	14	2500	356.0	356.0	35.0
SN74AHCT14NSR	SO	NS	14	2000	356.0	356.0	35.0
SN74AHCT14PWR	TSSOP	PW	14	2000	356.0	356.0	35.0
SN74AHCT14RGYR	VQFN	RGY	14	3000	356.0	356.0	35.0

**TUBE**

\*All dimensions are nominal

Device	Package Name	Package Type	Pins	SPQ	L (mm)	W (mm)	T (μm)	B (mm)
5962-9680101Q2A	FK	LCCC	20	1	506.98	12.06	2030	NA
5962-9680101QDA	W	CFP	14	1	506.98	26.16	6220	NA
5962-9680101VDA	W	CFP	14	1	506.98	26.16	6220	NA
SN74AHCT14D	D	SOIC	14	50	506.6	8	3940	4.32
SN74AHCT14DG4	D	SOIC	14	50	506.6	8	3940	4.32
SN74AHCT14N	N	PDIP	14	25	506	13.97	11230	4.32
SN74AHCT14N	N	PDIP	14	25	506	13.97	11230	4.32
SN74AHCT14PW	PW	TSSOP	14	90	530	10.2	3600	3.5
SNJ54AHCT14FK	FK	LCCC	20	1	506.98	12.06	2030	NA
SNJ54AHCT14W	W	CFP	14	1	506.98	26.16	6220	NA

FK (S-CQCC-N\*\*)

LEADLESS CERAMIC CHIP CARRIER

28 TERMINAL SHOWN



NO. OF TERMINALS **	A		B	
	MIN	MAX	MIN	MAX
20	0.342 (8,69)	0.358 (9,09)	0.307 (7,80)	0.358 (9,09)
28	0.442 (11,23)	0.458 (11,63)	0.406 (10,31)	0.458 (11,63)
44	0.640 (16,26)	0.660 (16,76)	0.495 (12,58)	0.560 (14,22)
52	0.740 (18,78)	0.761 (19,32)	0.495 (12,58)	0.560 (14,22)
68	0.938 (23,83)	0.962 (24,43)	0.850 (21,6)	0.858 (21,8)
84	1.141 (28,99)	1.165 (29,59)	1.047 (26,6)	1.063 (27,0)





4040140/D 01/11

- NOTES:
- All linear dimensions are in inches (millimeters).
  - This drawing is subject to change without notice.
  - This package can be hermetically sealed with a metal lid.
  - Falls within JEDEC MS-004

RGY (S-PVQFN-N14)

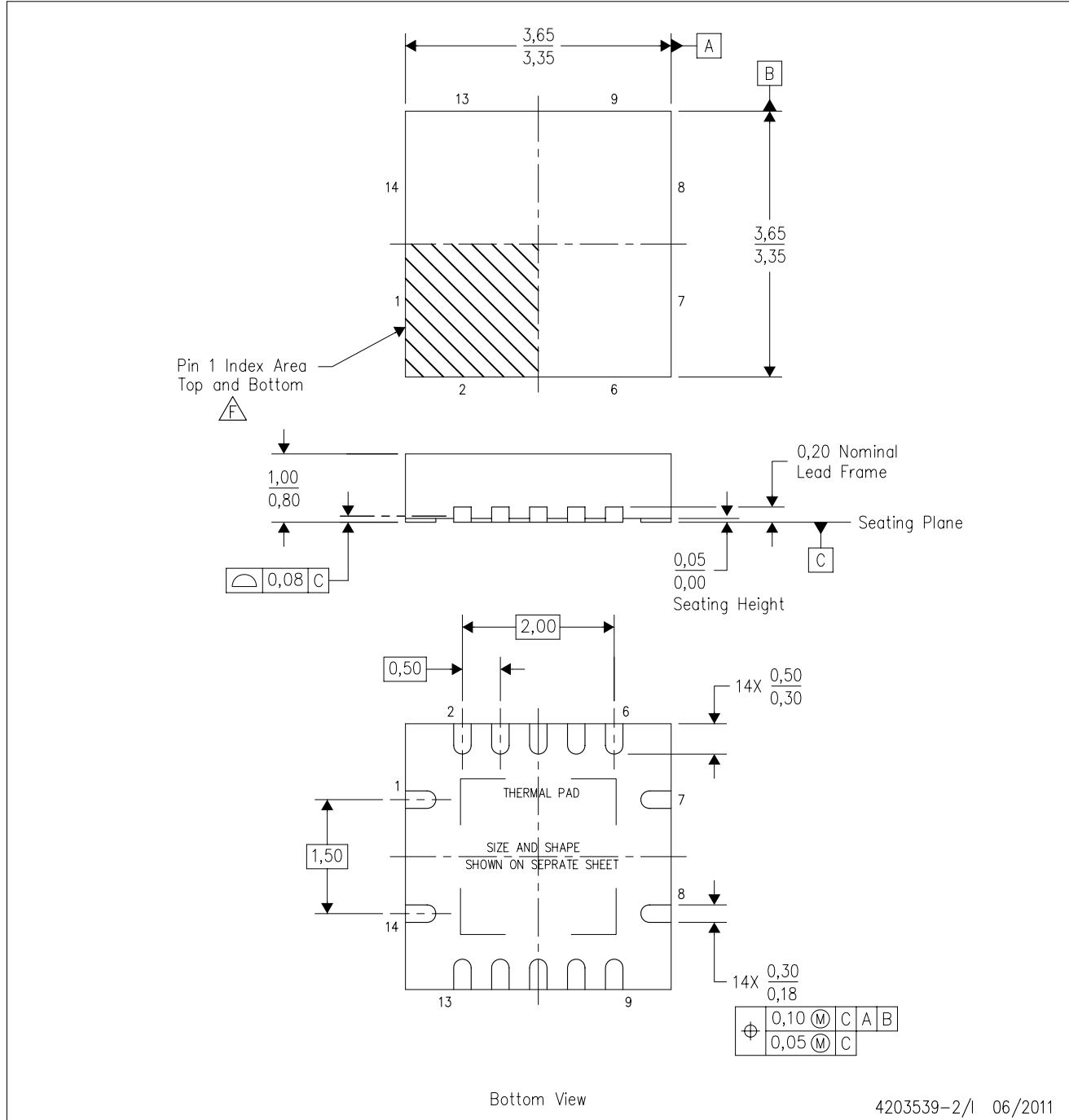
PLASTIC QUAD FLATPACK NO-LEAD



- NOTES:
- A. All linear dimensions are in millimeters. Dimensioning and tolerancing per ASME Y14.5M-1994.
  - B. This drawing is subject to change without notice.
  - C. QFN (Quad Flatpack No-Lead) package configuration.
  - D. The package thermal pad must be soldered to the board for thermal and mechanical performance.
  - E. See the additional figure in the Product Data Sheet for details regarding the exposed thermal pad features and dimensions.
  -  Pin 1 identifiers are located on both top and bottom of the package and within the zone indicated. The Pin 1 identifiers are either a molded, marked, or metal feature.
  - G. Package complies to JEDEC MO-241 variation BA.

RGY (S-PVQFN-N14)

PLASTIC QUAD FLATPACK NO-LEAD

**THERMAL INFORMATION**

This package incorporates an exposed thermal pad that is designed to be attached directly to an external heatsink. The thermal pad must be soldered directly to the printed circuit board (PCB). After soldering, the PCB can be used as a heatsink. In addition, through the use of thermal vias, the thermal pad can be attached directly to the appropriate copper plane shown in the electrical schematic for the device, or alternatively, can be attached to a special heatsink structure designed into the PCB. This design optimizes the heat transfer from the integrated circuit (IC).

For information on the Quad Flatpack No-Lead (QFN) package and its advantages, refer to Application Report, QFN/SON PCB Attachment, Texas Instruments Literature No. SLUA271. This document is available at [www.ti.com](http://www.ti.com).

The exposed thermal pad dimensions for this package are shown in the following illustration.



Bottom View

Exposed Thermal Pad Dimensions

4206353-2/P 03/14

NOTE: All linear dimensions are in millimeters

RGY (S-PVQFN-N14)

PLASTIC QUAD FLATPACK NO-LEAD



4208122-2/P 03/14

- NOTES:
- All linear dimensions are in millimeters.
  - This drawing is subject to change without notice.
  - Publication IPC-7351 is recommended for alternate designs.
  - This package is designed to be soldered to a thermal pad on the board. Refer to Application Note, Quad Flat-Pack QFN/SON PCB Attachment, Texas Instruments Literature No. SLUA271, and also the Product Data Sheets for specific thermal information, via requirements, and recommended board layout. These documents are available at [www.ti.com](http://www.ti.com) <<http://www.ti.com>>.
  - Laser cutting apertures with trapezoidal walls and also rounding corners will offer better paste release. Customers should contact their board assembly site for stencil design recommendations. Refer to IPC 7525 for stencil design considerations.
  - Customers should contact their board fabrication site for minimum solder mask web tolerances between signal pads.

## MECHANICAL DATA

NS (R-PDSO-G\*\*)

PLASTIC SMALL-OUTLINE PACKAGE

14-PINS SHOWN



- NOTES:
- A. All linear dimensions are in millimeters.
  - B. This drawing is subject to change without notice.
  - C. Body dimensions do not include mold flash or protrusion, not to exceed 0,15.

W (R-GDFP-F14)

CERAMIC DUAL FLATPACK



- NOTES:
- A. All linear dimensions are in inches (millimeters).
  - B. This drawing is subject to change without notice.
  - C. This package can be hermetically sealed with a ceramic lid using glass frit.
  - D. Index point is provided on cap for terminal identification only.
  - E. Falls within MIL STD 1835 GDFP1-F14



DGV (R-PDSO-G\*\*)

PLASTIC SMALL-OUTLINE

24 PINS SHOWN



- NOTES: A. All linear dimensions are in millimeters.  
 B. This drawing is subject to change without notice.  
 C. Body dimensions do not include mold flash or protrusion, not to exceed 0,15 per side.  
 D. Falls within JEDEC: 24/48 Pins – MO-153  
 14/16/20/56 Pins – MO-194

J 14

**GENERIC PACKAGE VIEW**  
**CDIP - 5.08 mm max height**  
CERAMIC DUAL IN LINE PACKAGE



Images above are just a representation of the package family, actual package may vary.  
Refer to the product data sheet for package details.

4040083-5/G

J0014A



# PACKAGE OUTLINE

CDIP - 5.08 mm max height

CERAMIC DUAL IN LINE PACKAGE



4214771/A 05/2017

## NOTES:

1. All controlling linear dimensions are in inches. Dimensions in brackets are in millimeters. Any dimension in brackets or parenthesis are for reference only. Dimensioning and tolerancing per ASME Y14.5M.
2. This drawing is subject to change without notice.
3. This package is hermetically sealed with a ceramic lid using glass frit.
4. Index point is provided on cap for terminal identification only and on press ceramic glass frit seal only.
5. Falls within MIL-STD-1835 and GDIP1-T14.

# EXAMPLE BOARD LAYOUT

J0014A

CDIP - 5.08 mm max height

CERAMIC DUAL IN LINE PACKAGE



LAND PATTERN EXAMPLE  
NON-SOLDER MASK DEFINED  
SCALE: 5X





4214771/A 05/2017

D (R-PDSO-G14)

PLASTIC SMALL OUTLINE



4040047-5/M 06/11

- NOTES:
- A. All linear dimensions are in inches (millimeters).
  - B. This drawing is subject to change without notice.
  -  Body length does not include mold flash, protrusions, or gate burrs. Mold flash, protrusions, or gate burrs shall not exceed 0.006 (0,15) each side.
  -  Body width does not include interlead flash. Interlead flash shall not exceed 0.017 (0,43) each side.
  - E. Reference JEDEC MS-012 variation AB.

D (R-PDSO-G14)

PLASTIC SMALL OUTLINE

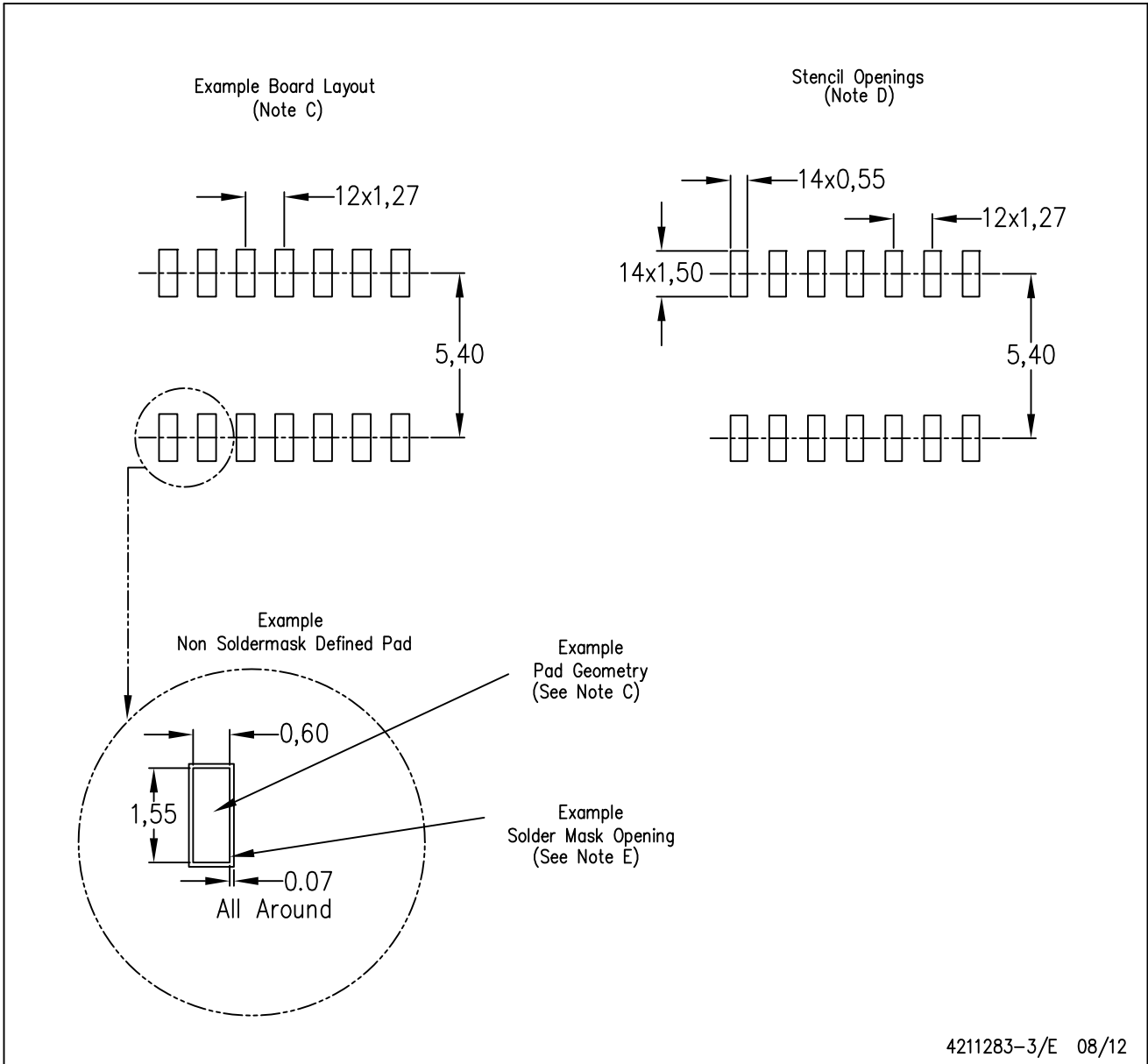

- NOTES:
- All linear dimensions are in millimeters.
  - This drawing is subject to change without notice.
  - Publication IPC-7351 is recommended for alternate designs.
  - Laser cutting apertures with trapezoidal walls and also rounding corners will offer better paste release. Customers should contact their board assembly site for stencil design recommendations. Refer to IPC-7525 for other stencil recommendations.
  - Customers should contact their board fabrication site for solder mask tolerances between and around signal pads.

# MECHANICAL DATA

PW (R-PDSO-G14)

PLASTIC SMALL OUTLINE



- NOTES:
- A. All linear dimensions are in millimeters. Dimensioning and tolerancing per ASME Y14.5M-1994.
  - B. This drawing is subject to change without notice.
  - C. Body length does not include mold flash, protrusions, or gate burrs. Mold flash, protrusions, or gate burrs shall not exceed 0,15 each side.
  - D. Body width does not include interlead flash. Interlead flash shall not exceed 0,25 each side.
  - E. Falls within JEDEC MO-153

PW (R-PDSO-G14)

PLASTIC SMALL OUTLINE



- NOTES:
- All linear dimensions are in millimeters.
  - This drawing is subject to change without notice.
  - Publication IPC-7351 is recommended for alternate designs.
  - Laser cutting apertures with trapezoidal walls and also rounding corners will offer better paste release. Customers should contact their board assembly site for stencil design recommendations. Refer to IPC-7525 for other stencil recommendations.
  - Customers should contact their board fabrication site for solder mask tolerances between and around signal pads.



N (R-PDIP-T\*\*)

PLASTIC DUAL-IN-LINE PACKAGE

16 PINS SHOWN



4040049/E 12/2002

- NOTES:
- A. All linear dimensions are in inches (millimeters).
  - B. This drawing is subject to change without notice.
  - (C) Falls within JEDEC MS-001, except 18 and 20 pin minimum body length (Dim A).
  - (D) The 20 pin end lead shoulder width is a vendor option, either half or full width.

DB (R-PDSO-G\*\*)

PLASTIC SMALL-OUTLINE

28 PINS SHOWN



- NOTES: A. All linear dimensions are in millimeters.  
 B. This drawing is subject to change without notice.  
 C. Body dimensions do not include mold flash or protrusion not to exceed 0,15.  
 D. Falls within JEDEC MO-150

## IMPORTANT NOTICE AND DISCLAIMER

TI PROVIDES TECHNICAL AND RELIABILITY DATA (INCLUDING DATA SHEETS), DESIGN RESOURCES (INCLUDING REFERENCE DESIGNS), APPLICATION OR OTHER DESIGN ADVICE, WEB TOOLS, SAFETY INFORMATION, AND OTHER RESOURCES "AS IS" AND WITH ALL FAULTS, AND DISCLAIMS ALL WARRANTIES, EXPRESS AND IMPLIED, INCLUDING WITHOUT LIMITATION ANY IMPLIED WARRANTIES OF MERCHANTABILITY, FITNESS FOR A PARTICULAR PURPOSE OR NON-INFRINGEMENT OF THIRD PARTY INTELLECTUAL PROPERTY RIGHTS.

These resources are intended for skilled developers designing with TI products. You are solely responsible for (1) selecting the appropriate TI products for your application, (2) designing, validating and testing your application, and (3) ensuring your application meets applicable standards, and any other safety, security, regulatory or other requirements.

These resources are subject to change without notice. TI grants you permission to use these resources only for development of an application that uses the TI products described in the resource. Other reproduction and display of these resources is prohibited. No license is granted to any other TI intellectual property right or to any third party intellectual property right. TI disclaims responsibility for, and you will fully indemnify TI and its representatives against, any claims, damages, costs, losses, and liabilities arising out of your use of these resources.

TI's products are provided subject to [TI's Terms of Sale](#) or other applicable terms available either on [ti.com](http://ti.com) or provided in conjunction with such TI products. TI's provision of these resources does not expand or otherwise alter TI's applicable warranties or warranty disclaimers for TI products.

TI objects to and rejects any additional or different terms you may have proposed.

Mailing Address: Texas Instruments, Post Office Box 655303, Dallas, Texas 75265  
Copyright © 2022, Texas Instruments Incorporated