

LOW-POWER TRIPLE SCHMITT-TRIGGER BUFFER

Check for Samples: [SN74AUP3G17](#)

FEATURES

- Available in the Texas Instruments NanoStar™ Package
- Low Static-Power Consumption ($I_{CC} = 0.9 \mu\text{A}$ Maximum)
- Low Dynamic-Power Consumption ($C_{pd} = 4.3 \text{ pF}$ Typ at 3.3 V)
- Low Input Capacitance ($C_i = 1.5 \text{ pF}$ Typical)
- Low Noise – Overshoot and Undershoot <math><10\%</math> of V_{CC}
- I_{off} Supports Partial-Power-Down Mode Operation
- Wide Operating V_{CC} Range of 0.8 V to 3.6 V
- Optimized for 3.3-V Operation
- 3.6-V I/O Tolerant to Support Mixed-Mode Signal Operation
- $t_{pd} = 5.1 \text{ ns}$ Maximum at 3.3 V
- Suitable for Point-to-Point Applications
- Latch-Up Performance Exceeds 100 mA Per JESD 78, Class II
- ESD Performance Tested Per JESD 22
 - 2000-V Human-Body Model (A114-B, Class II)
 - 1000-V Charged-Device Model (C101)

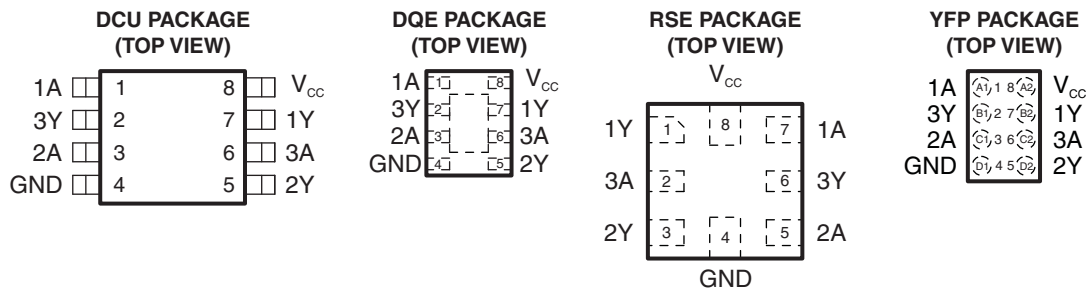

See mechanical drawings for dimensions.

DESCRIPTION/ORDERING INFORMATION

The AUP family is TI's premier solution to the industry's low-power needs in battery-powered portable applications. This family ensures a very low static- and dynamic-power consumption across the entire V_{CC} range of 0.8 V to 3.6 V, resulting in increased battery life (see [Figure 1](#)). This product also maintains excellent signal integrity (see the very low undershoot and overshoot characteristics shown in [Figure 2](#)).



(A) Single, dual, and triple gates

Figure 1. AUP – The Lowest-Power Family

(A) SN74AUP3Gxx data at $C_L = 15 \text{ pF}$.

Figure 2. Excellent Signal Integrity

Please be aware that an important notice concerning availability, standard warranty, and use in critical applications of Texas Instruments semiconductor products and disclaimers thereto appears at the end of this data sheet.

NanoStar is a trademark of Texas Instruments.

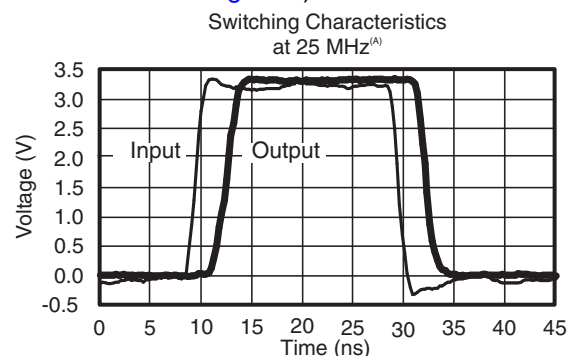
The SN74LVC3G17 contains three buffers and performs the Boolean function $Y = A$. The device functions as three independent buffers but, because of Schmitt action, it may have different input threshold levels for positive-going (V_{T+}) and negative-going (V_{T-}) signals.

NanoStar™ package technology is a major breakthrough in IC packaging concepts, using the die as the package.

This device is fully specified for partial-power-down applications using I_{off} . The I_{off} circuitry disables the outputs, preventing damaging current backflow through the device when it is powered down.

ORDERING INFORMATION⁽¹⁾

| T _A | PACKAGE ⁽²⁾ | | ORDERABLE PART NUMBER | TOP-SIDE MARKING ⁽³⁾ |
|----------------|--|--------------|-----------------------|---------------------------------|
| -40°C to 85°C | NanoStar™ – WCSP (DSBGA) 0.23-mm Large Bump – YFP (Pb-free) | Reel of 3000 | SN74AUP3G17YFPR | _ _ H 7 _ |
| | uQFN – DQE | Reel of 5000 | SN74AUP3G17DQER | TY |
| | QFN – RSE | Reel of 5000 | SN74AUP3G17RSER | TY |
| | SSOP – DCU | Reel of 3000 | SN74AUP3G17DCUR | H17_ |

- (1) For the most current package and ordering information, see the Package Option Addendum at the end of this document, or see the TI web site at www.ti.com.
- (2) Package drawings, thermal data, and symbolization are available at www.ti.com/packaging.
- (3) DCU: The actual top-side marking has one additional character that designates the wafer fab/assembly site.
YFP: The actual top-side marking has three preceding characters to denote year, month, and sequence code, and one following character to designate the wafer fab/assembly site. Pin 1 identifier indicates solder-bump composition (1 = SnPb, • = Pb-free).

FUNCTION TABLE

| INPUT A | OUTPUT Y |
|---------|----------|
| H | H |
| L | L |

LOGIC DIAGRAM (POSITIVE LOGIC)



Pin numbers shown are for the DCU and DQE packages.

ABSOLUTE MAXIMUM RATINGS⁽¹⁾

over operating free-air temperature range (unless otherwise noted)

| | | MIN | MAX | UNIT |
|---------------|---|-------------|----------------|------|
| V_{CC} | Supply voltage range | -0.5 | 4.6 | V |
| V_I | Input voltage range ⁽²⁾ | -0.5 | 4.6 | V |
| V_O | Voltage range applied to any output in the high-impedance or power-off state ⁽²⁾ | -0.5 | 4.6 | V |
| V_O | Output voltage range in the high or low state ⁽²⁾ | -0.5 | $V_{CC} + 0.5$ | V |
| I_{IK} | Input clamp current | $V_I < 0$ | -50 | mA |
| I_{OK} | Output clamp current | $V_O < 0$ | -50 | mA |
| I_O | Continuous output current | | ±20 | mA |
| | Continuous current through V_{CC} or GND | | ±50 | mA |
| θ_{JA} | Package thermal impedance ⁽³⁾ | DCU package | 220 | °C/W |
| | | DQE package | 261 | |
| | | RSE package | 253 | |
| | | YFP package | 132 | |
| T_{stg} | Storage temperature range | -65 | 150 | °C |

- (1) Stresses beyond those listed under "absolute maximum ratings" may cause permanent damage to the device. These are stress ratings only, and functional operation of the device at these or any other conditions beyond those indicated under "recommended operating conditions" is not implied. Exposure to absolute-maximum-rated conditions for extended periods may affect device reliability.
- (2) The input negative-voltage and output voltage ratings may be exceeded if the input and output current ratings are observed.
- (3) The package thermal impedance is calculated in accordance with JEDEC 51-7.

RECOMMENDED OPERATING CONDITIONS ⁽¹⁾

| | | MIN | MAX | UNIT |
|-----------------|--------------------------------|--------------------------|-----------------|------|
| V _{CC} | Supply voltage | 0.8 | 3.6 | V |
| V _I | Input voltage | 0 | 3.6 | V |
| V _O | Output voltage | 0 | V _{CC} | V |
| I _{OH} | High-level output current | V _{CC} = 0.8 V | -20 | μA |
| | | V _{CC} = 1.1 V | -1.1 | mA |
| | | V _{CC} = 1.4 V | -1.7 | |
| | | V _{CC} = 1.65 | -1.9 | |
| | | V _{CC} = 2.3 V | -3.1 | |
| | | V _{CC} = 3 V | -4 | |
| I _{OL} | Low-level output current | V _{CC} = 0.8 V | 20 | μA |
| | | V _{CC} = 1.1 V | 1.1 | mA |
| | | V _{CC} = 1.4 V | 1.7 | |
| | | V _{CC} = 1.65 V | 1.9 | |
| | | V _{CC} = 2.3 V | 3.1 | |
| | | V _{CC} = 3 V | 4 | |
| T _A | Operating free-air temperature | -40 | 85 | °C |

(1) All unused inputs of the device must be held at V_{CC} or GND to ensure proper device operation. Refer to the TI application report, *Implications of Slow or Floating CMOS Inputs*, literature number SCBA004.

ELECTRICAL CHARACTERISTICS

over recommended operating free-air temperature range (unless otherwise noted)

| PARAMETER | TEST CONDITIONS | V _{CC} | T _A = 25°C | | | T _A = –40°C to 85°C | | UNIT |
|---|---|---|------------------------|------|-----------------------|--------------------------------|------|------|
| | | | MIN | TYP | MAX | MIN | MAX | |
| V _{T+} Positive-going input threshold voltage | | 0.8 V | | 0.3 | 0.6 | 0.3 | 0.6 | V |
| | | 1.1 V | | 0.53 | 0.9 | 0.53 | 0.9 | |
| | | 1.4 V | | 0.74 | 1.11 | 0.74 | 1.11 | |
| | | 1.65 V | | 0.91 | 1.29 | 0.91 | 1.29 | |
| | | 2.3 V | | 1.37 | 1.77 | 1.37 | 1.77 | |
| | | 3 V | | 1.88 | 2.29 | 1.88 | 2.29 | |
| V _{T–} Negative-going input threshold voltage | | 0.8 V | | 0.1 | 0.6 | 0.1 | 0.6 | V |
| | | 1.1 V | | 0.26 | 0.65 | 0.26 | 0.65 | |
| | | 1.4 V | | 0.39 | 0.75 | 0.39 | 0.75 | |
| | | 1.65 V | | 0.47 | 0.84 | 0.47 | 0.84 | |
| | | 2.3 V | | 0.69 | 1.04 | 0.69 | 1.04 | |
| | | 3 V | | 0.88 | 1.24 | 0.88 | 1.24 | |
| ΔV _T Hysteresis (V _{T+} – V _{T–}) | | 0.8 V | | 0.07 | 0.5 | 0.07 | 0.5 | V |
| | | 1.1 V | | 0.08 | 0.46 | 0.08 | 0.46 | |
| | | 1.4 V | | 0.18 | 0.56 | 0.18 | 0.56 | |
| | | 1.65 V | | 0.27 | 0.66 | 0.27 | 0.66 | |
| | | 2.3 V | | 0.53 | 0.92 | 0.53 | 0.92 | |
| | | 3 V | | 0.79 | 1.31 | 0.79 | 1.31 | |
| V _{OH} | I _{OH} = –20 μA | 0.8 V to 3.6 V | V _{CC} – 0.1 | | V _{CC} – 0.1 | | V | |
| | I _{OH} = –1.1 mA | 1.1 V | 0.75 × V _{CC} | | 0.7 × V _{CC} | | | |
| | I _{OH} = –1.7 mA | 1.4 V | 1.11 | | 1.03 | | | |
| | I _{OH} = –1.9 mA | 1.65 V | 1.32 | | 1.3 | | | |
| | I _{OH} = –2.3 mA | 2.3 V | 2.05 | | 1.97 | | | |
| | I _{OH} = –3.1 mA | | 1.9 | | 1.85 | | | |
| | I _{OH} = –2.7 mA | 3 V | 2.72 | | 2.67 | | | |
| | I _{OH} = –4 mA | | 2.6 | | 2.55 | | | |
| V _{OL} | I _{OL} = 20 μA | 0.8 V to 3.6 V | 0.1 | | 0.1 | | V | |
| | I _{OL} = 1.1 mA | 1.1 V | 0.3 × V _{CC} | | 0.3 × V _{CC} | | | |
| | I _{OL} = 1.7 mA | 1.4 V | 0.31 | | 0.37 | | | |
| | I _{OL} = 1.9 mA | 1.65 V | 0.31 | | 0.35 | | | |
| | I _{OL} = 2.3 mA | 2.3 V | 0.31 | | 0.33 | | | |
| | I _{OL} = 3.1 mA | | 0.44 | | 0.45 | | | |
| | I _{OL} = 2.7 mA | 3 V | 0.31 | | 0.33 | | | |
| | I _{OL} = 4 mA | | 0.44 | | 0.45 | | | |
| I _I | A or B input | V _I = GND to 3.6 V | 0 V to 3.6 V | | 0.1 | 0.5 | μA | |
| I _{off} | | V _I or V _O = 0 V to 3.6 V | 0 V | | 0.2 | 0.6 | μA | |
| ΔI _{off} | | V _I or V _O = 0 V to 3.6 V | 0 V to 0.2 V | | 0.2 | 0.6 | μA | |
| I _{CC} | | V _I = GND or (V _{CC} to 3.6 V), I _O = 0 | 0.8 V to 3.6 V | | 0.5 | 0.9 | μA | |
| ΔI _{CC} | | V _I = V _{CC} – 0.6 V ⁽¹⁾ , I _O = 0 | 3.3 V | | 40 | 50 | μA | |
| C _i | V _I = V _{CC} or GND | 0 V | 1.5 | | | | pF | |
| | | 3.6 V | 1.5 | | | | | |
| C _O | V _O = GND | 0 V | 3 | | | | pF | |

 (1) One input at V_{CC} – 0.6 V, other input at V_{CC} or GND

SWITCHING CHARACTERISTICSover recommended operating free-air temperature range, $C_L = 5$ pF (unless otherwise noted) (see [Figure 3](#) and [Figure 4](#))

| PARAMETER | FROM (INPUT) | TO (OUTPUT) | V_{CC} | $T_A = 25^\circ\text{C}$ | | | $T_A = -40^\circ\text{C to } 85^\circ\text{C}$ | | UNIT |
|-----------|-----------------|----------------|----------------------------------|--------------------------|-----|------|--|------|------|
| | | | | MIN | TYP | MAX | MIN | MAX | |
| t_{pd} | A | Y | 0.8 V | 22.7 | | | | | ns |
| | | | $1.2\text{ V} \pm 0.1\text{ V}$ | 6.3 | 8 | 12.8 | 3.9 | 14.6 | |
| | | | $1.5\text{ V} \pm 0.1\text{ V}$ | 4.6 | 5.8 | 8.4 | 2.8 | 10 | |
| | | | $1.8\text{ V} \pm 0.15\text{ V}$ | 3.9 | 4.8 | 7.2 | 2.4 | 8.1 | |
| | | | $2.5\text{ V} \pm 0.2\text{ V}$ | 3.1 | 3.6 | 5.1 | 2 | 6.1 | |
| | | | $3.3\text{ V} \pm 0.3\text{ V}$ | 2.7 | 3 | 4.4 | 1.9 | 5.1 | |

SWITCHING CHARACTERISTICSover recommended operating free-air temperature range, $C_L = 10$ pF (unless otherwise noted) (see [Figure 3](#) and [Figure 4](#))

| PARAMETER | FROM (INPUT) | TO (OUTPUT) | V_{CC} | $T_A = 25^\circ\text{C}$ | | | $T_A = -40^\circ\text{C to } 85^\circ\text{C}$ | | UNIT |
|-----------|-----------------|----------------|----------------------------------|--------------------------|-----|------|--|------|------|
| | | | | MIN | TYP | MAX | MIN | MAX | |
| t_{pd} | A | Y | 0.8 V | 25.1 | | | | | ns |
| | | | $1.2\text{ V} \pm 0.1\text{ V}$ | 7.1 | 9.1 | 13.8 | 4.7 | 15.6 | |
| | | | $1.5\text{ V} \pm 0.1\text{ V}$ | 5.2 | 6.5 | 9.4 | 3.4 | 11 | |
| | | | $1.8\text{ V} \pm 0.15\text{ V}$ | 4.5 | 5.4 | 8 | 2.9 | 9 | |
| | | | $2.5\text{ V} \pm 0.2\text{ V}$ | 3.5 | 4.2 | 5.7 | 2.4 | 6.8 | |
| | | | $3.3\text{ V} \pm 0.3\text{ V}$ | 3.1 | 3.5 | 4.9 | 2.2 | 5.7 | |

SWITCHING CHARACTERISTICSover recommended operating free-air temperature range, $C_L = 15$ pF (unless otherwise noted) (see [Figure 3](#) and [Figure 4](#))

| PARAMETER | FROM (INPUT) | TO (OUTPUT) | V_{CC} | $T_A = 25^\circ\text{C}$ | | | $T_A = -40^\circ\text{C to } 85^\circ\text{C}$ | | UNIT |
|-----------|-----------------|----------------|----------------------------------|--------------------------|------|------|--|------|------|
| | | | | MIN | TYP | MAX | MIN | MAX | |
| t_{pd} | A | Y | 0.8 V | 27.6 | | | | | ns |
| | | | $1.2\text{ V} \pm 0.1\text{ V}$ | 7.8 | 10.1 | 14.8 | 5.3 | 16.7 | |
| | | | $1.5\text{ V} \pm 0.1\text{ V}$ | 5.8 | 7.4 | 10.3 | 3.9 | 12 | |
| | | | $1.8\text{ V} \pm 0.15\text{ V}$ | 5 | 6.1 | 8.8 | 3.4 | 10 | |
| | | | $2.5\text{ V} \pm 0.2\text{ V}$ | 4 | 4.7 | 6.4 | 2.8 | 7.5 | |
| | | | $3.3\text{ V} \pm 0.3\text{ V}$ | 3.5 | 4.1 | 5.4 | 2.6 | 6.2 | |

SWITCHING CHARACTERISTICSover recommended operating free-air temperature range, $C_L = 30$ pF (unless otherwise noted) (see [Figure 3](#) and [Figure 4](#))

| PARAMETER | FROM (INPUT) | TO (OUTPUT) | V_{CC} | $T_A = 25^\circ\text{C}$ | | | $T_A = -40^\circ\text{C to } 85^\circ\text{C}$ | | UNIT |
|-----------|-----------------|----------------|----------------------------------|--------------------------|------|------|--|------|------|
| | | | | MIN | TYP | MAX | MIN | MAX | |
| t_{pd} | A | Y | 0.8 V | 35.1 | | | | | ns |
| | | | $1.2\text{ V} \pm 0.1\text{ V}$ | 10 | 13.1 | 18.1 | 7.5 | 19.8 | |
| | | | $1.5\text{ V} \pm 0.1\text{ V}$ | 7.4 | 9.6 | 12.9 | 5.6 | 14.9 | |
| | | | $1.8\text{ V} \pm 0.15\text{ V}$ | 6.4 | 7.9 | 11 | 4.8 | 12.4 | |
| | | | $2.5\text{ V} \pm 0.2\text{ V}$ | 5.2 | 6.1 | 8.1 | 4 | 9.3 | |
| | | | $3.3\text{ V} \pm 0.3\text{ V}$ | 4.6 | 5.3 | 6.9 | 3.6 | 7.7 | |

OPERATING CHARACTERISTICS
 $T_A = 25^\circ\text{C}$

| PARAMETER | | TEST CONDITIONS | V_{CC} | TYP | UNIT |
|-----------|-------------------------------|---------------------|----------------------------------|-----|------|
| C_{pd} | Power dissipation capacitance | $f = 10\text{ MHz}$ | 0.8 V | 4 | pF |
| | | | $1.2\text{ V} \pm 0.1\text{ V}$ | 4 | |
| | | | $1.5\text{ V} \pm 0.1\text{ V}$ | 4 | |
| | | | $1.8\text{ V} \pm 0.15\text{ V}$ | 4 | |
| | | | $2.5\text{ V} \pm 0.2\text{ V}$ | 4.1 | |
| | | | $3.3\text{ V} \pm 0.3\text{ V}$ | 4.3 | |

PARAMETER MEASUREMENT INFORMATION
(Propagation Delays, Setup and Hold Times, and Pulse Width)



LOAD CIRCUIT

| | $V_{CC} = 0.8\text{ V}$ | $V_{CC} = 1.2\text{ V}$ $\pm 0.1\text{ V}$ | $V_{CC} = 1.5\text{ V}$ $\pm 0.1\text{ V}$ | $V_{CC} = 1.8\text{ V}$ $\pm 0.15\text{ V}$ | $V_{CC} = 2.5\text{ V}$ $\pm 0.2\text{ V}$ | $V_{CC} = 3.3\text{ V}$ $\pm 0.3\text{ V}$ |
|-------|-------------------------|---|---|--|---|---|
| C_L | 5, 10, 15, 30 pF | 5, 10, 15, 30 pF | 5, 10, 15, 30 pF | 5, 10, 15, 30 pF | 5, 10, 15, 30 pF | 5, 10, 15, 30 pF |
| V_M | $V_{CC}/2$ | $V_{CC}/2$ | $V_{CC}/2$ | $V_{CC}/2$ | $V_{CC}/2$ | $V_{CC}/2$ |
| V_I | V_{CC} | V_{CC} | V_{CC} | V_{CC} | V_{CC} | V_{CC} |



- A. C_L includes probe and jig capacitance.
- B. Waveform 1 is for an output with internal conditions such that the output is low, except when disabled by the output control. Waveform 2 is for an output with internal conditions such that the output is high, except when disabled by the output control.
- C. All input pulses are supplied by generators having the following characteristics: $PRR \leq 10\text{ MHz}$, $Z_O = 50\ \Omega$, for propagation delays $t_r/t_f = 3\text{ ns}$, for setup and hold times and pulse width $t_r/t_f = 1.2\text{ ns}$.
- D. The outputs are measured one at a time, with one transition per measurement.
- E. t_{PLH} and t_{PHL} are the same as t_{pd} .
- F. All parameters and waveforms are not applicable to all devices.

Figure 3. Load Circuit and Voltage Waveforms

**PARAMETER MEASUREMENT INFORMATION
(Enable and Disable Times)**

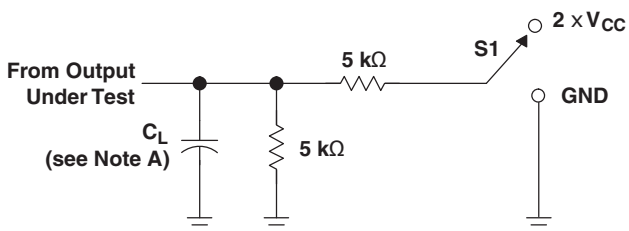

| TEST | S1 |
|-------------------|-------------------|
| t_{PLZ}/t_{PZL} | $2 \times V_{CC}$ |
| t_{PHZ}/t_{PHL} | GND |

LOAD CIRCUIT

| | $V_{CC} = 0.8 \text{ V}$ | $V_{CC} = 1.2 \text{ V} \pm 0.1 \text{ V}$ | $V_{CC} = 1.5 \text{ V} \pm 0.1 \text{ V}$ | $V_{CC} = 1.8 \text{ V} \pm 0.15 \text{ V}$ | $V_{CC} = 2.5 \text{ V} \pm 0.2 \text{ V}$ | $V_{CC} = 3.3 \text{ V} \pm 0.3 \text{ V}$ |
|--------------|--------------------------|--|--|---|--|--|
| C_L | 5, 10, 15, 30 pF | 5, 10, 15, 30 pF | 5, 10, 15, 30 pF | 5, 10, 15, 30 pF | 5, 10, 15, 30 pF | 5, 10, 15, 30 pF |
| V_M | $V_{CC}/2$ | $V_{CC}/2$ | $V_{CC}/2$ | $V_{CC}/2$ | $V_{CC}/2$ | $V_{CC}/2$ |
| V_I | V_{CC} | V_{CC} | V_{CC} | V_{CC} | V_{CC} | V_{CC} |
| V_{Δ} | 0.1 V | 0.1 V | 0.1 V | 0.15 V | 0.15 V | 0.3 V |



**VOLTAGE WAVEFORMS
ENABLE AND DISABLE TIMES
LOW- AND HIGH-LEVEL ENABLING**

- A. C_L includes probe and jig capacitance.
- B. Waveform 1 is for an output with internal conditions such that the output is low, except when disabled by the output control. Waveform 2 is for an output with internal conditions such that the output is high, except when disabled by the output control.
- C. All input pulses are supplied by generators having the following characteristics: $PRR \leq 10 \text{ MHz}$, $Z_O = 50 \Omega$, $t_r/t_f = 3 \text{ ns}$.
- D. The outputs are measured one at a time, with one transition per measurement.
- E. t_{PLZ} and t_{PHZ} are the same as t_{dis} .
- F. t_{PLH} and t_{PHL} are the same as t_{pd} .
- G. All parameters and waveforms are not applicable to all devices.

Figure 4. Load Circuit and Voltage Waveforms

REVISION HISTORY

| Changes from Revision B (July 2010) to Revision C | Page |
|--|------|
| • Changed logic diagram from inverting to non-inverting amplifiers | 2 |
| • Deleted input transition rise or fall rate ($\Delta t/\Delta v$) parameter from Recommended Operation Conditions table | 4 |

PACKAGING INFORMATION

| Orderable Device | Status (1) | Package Type | Package Drawing | Pins | Package Qty | Eco Plan (2) | Lead finish/ Ball material (6) | MSL Peak Temp (3) | Op Temp (°C) | Device Marking (4/5) | Samples |
|------------------|---------------|--------------|-----------------|------|-------------|-----------------|--------------------------------------|----------------------|--------------|-------------------------|-------------------------|
| SN74AUP3G17DCUR | ACTIVE | VSSOP | DCU | 8 | 3000 | RoHS & Green | NIPDAU | Level-1-260C-UNLIM | -40 to 85 | H17R | Samples |
| SN74AUP3G17DQER | ACTIVE | X2SON | DQE | 8 | 5000 | RoHS & Green | NIPDAUAG | Level-1-260C-UNLIM | -40 to 85 | TY | Samples |
| SN74AUP3G17RSER | ACTIVE | UQFN | RSE | 8 | 5000 | RoHS & Green | NIPDAUAG | Level-1-260C-UNLIM | -40 to 85 | TY | Samples |
| SN74AUP3G17YFPR | ACTIVE | DSBGA | YFP | 8 | 3000 | RoHS & Green | SNAGCU | Level-1-260C-UNLIM | -40 to 85 | H7N | Samples |

(1) The marketing status values are defined as follows:

ACTIVE: Product device recommended for new designs.

LIFEBUY: TI has announced that the device will be discontinued, and a lifetime-buy period is in effect.

NRND: Not recommended for new designs. Device is in production to support existing customers, but TI does not recommend using this part in a new design.

PREVIEW: Device has been announced but is not in production. Samples may or may not be available.

OBSOLETE: TI has discontinued the production of the device.

(2) **RoHS:** TI defines "RoHS" to mean semiconductor products that are compliant with the current EU RoHS requirements for all 10 RoHS substances, including the requirement that RoHS substance do not exceed 0.1% by weight in homogeneous materials. Where designed to be soldered at high temperatures, "RoHS" products are suitable for use in specified lead-free processes. TI may reference these types of products as "Pb-Free".

RoHS Exempt: TI defines "RoHS Exempt" to mean products that contain lead but are compliant with EU RoHS pursuant to a specific EU RoHS exemption.

Green: TI defines "Green" to mean the content of Chlorine (Cl) and Bromine (Br) based flame retardants meet JS709B low halogen requirements of <=1000ppm threshold. Antimony trioxide based flame retardants must also meet the <=1000ppm threshold requirement.

(3) **MSL, Peak Temp.** - The Moisture Sensitivity Level rating according to the JEDEC industry standard classifications, and peak solder temperature.

(4) There may be additional marking, which relates to the logo, the lot trace code information, or the environmental category on the device.

(5) Multiple Device Markings will be inside parentheses. Only one Device Marking contained in parentheses and separated by a "-" will appear on a device. If a line is indented then it is a continuation of the previous line and the two combined represent the entire Device Marking for that device.

(6) **Lead finish/Ball material** - Orderable Devices may have multiple material finish options. Finish options are separated by a vertical ruled line. Lead finish/Ball material values may wrap to two lines if the finish value exceeds the maximum column width.

Important Information and Disclaimer:The information provided on this page represents TI's knowledge and belief as of the date that it is provided. TI bases its knowledge and belief on information provided by third parties, and makes no representation or warranty as to the accuracy of such information. Efforts are underway to better integrate information from third parties. TI has taken and

continues to take reasonable steps to provide representative and accurate information but may not have conducted destructive testing or chemical analysis on incoming materials and chemicals. TI and TI suppliers consider certain information to be proprietary, and thus CAS numbers and other limited information may not be available for release.

In no event shall TI's liability arising out of such information exceed the total purchase price of the TI part(s) at issue in this document sold by TI to Customer on an annual basis.

TAPE AND REEL INFORMATION



QUADRANT ASSIGNMENTS FOR PIN 1 ORIENTATION IN TAPE



*All dimensions are nominal

| Device | Package Type | Package Drawing | Pins | SPQ | Reel Diameter (mm) | Reel Width W1 (mm) | A0 (mm) | B0 (mm) | K0 (mm) | P1 (mm) | W (mm) | Pin1 Quadrant |
|-----------------|--------------|-----------------|------|------|--------------------|--------------------|---------|---------|---------|---------|--------|---------------|
| SN74AUP3G17DCUR | VSSOP | DCU | 8 | 3000 | 180.0 | 8.4 | 2.25 | 3.35 | 1.05 | 4.0 | 8.0 | Q3 |
| SN74AUP3G17DQER | X2SON | DQE | 8 | 5000 | 180.0 | 8.4 | 1.2 | 1.6 | 0.55 | 4.0 | 8.0 | Q1 |
| SN74AUP3G17RSER | UQFN | RSE | 8 | 5000 | 180.0 | 8.4 | 1.7 | 1.7 | 0.7 | 4.0 | 8.0 | Q2 |
| SN74AUP3G17YFPR | DSBGA | YFP | 8 | 3000 | 178.0 | 9.2 | 0.9 | 1.75 | 0.6 | 4.0 | 8.0 | Q1 |

TAPE AND REEL BOX DIMENSIONS

*All dimensions are nominal

| Device | Package Type | Package Drawing | Pins | SPQ | Length (mm) | Width (mm) | Height (mm) |
|-----------------|--------------|-----------------|------|------|-------------|------------|-------------|
| SN74AUP3G17DCUR | VSSOP | DCU | 8 | 3000 | 202.0 | 201.0 | 28.0 |
| SN74AUP3G17DQER | X2SON | DQE | 8 | 5000 | 202.0 | 201.0 | 28.0 |
| SN74AUP3G17RSER | UQFN | RSE | 8 | 5000 | 202.0 | 201.0 | 28.0 |
| SN74AUP3G17YFPR | DSBGA | YFP | 8 | 3000 | 220.0 | 220.0 | 35.0 |

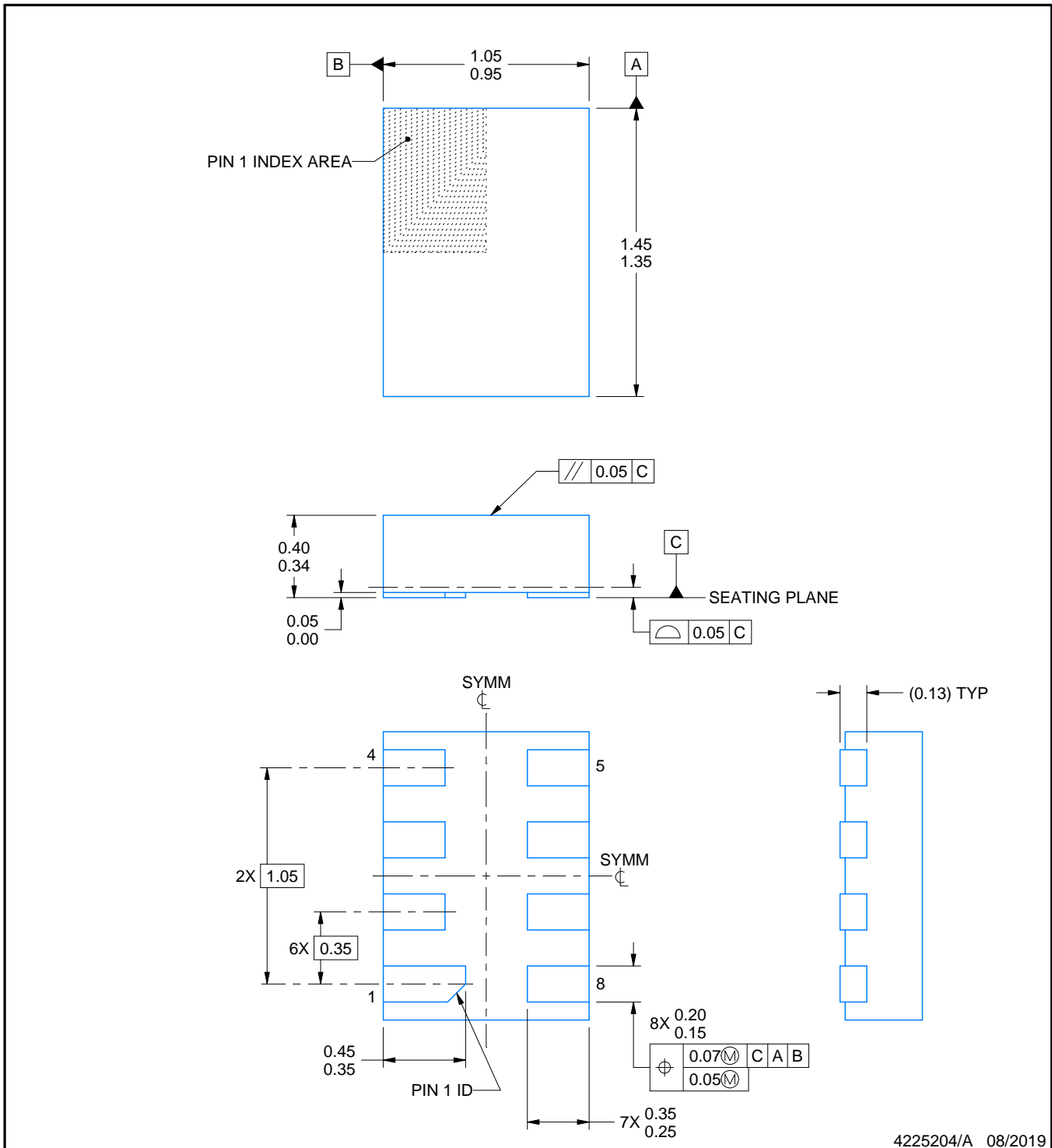

4225204/A 08/2019

NOTES:

1. All linear dimensions are in millimeters. Any dimensions in parenthesis are for reference only. Dimensioning and tolerancing per ASME Y14.5M.
2. This drawing is subject to change without notice.
3. This package complies to JEDEC MO-287 variation X2EAF.

EXAMPLE BOARD LAYOUT

DQE0008A

X2SON - 0.4 mm max height

PLASTIC SMALL OUTLINE - NO LEAD



LAND PATTERN EXAMPLE
EXPOSED METAL SHOWN
SCALE: 40X



SOLDER MASK DETAILS

4225204/A 08/2019

NOTES: (continued)

- This package is designed to be soldered to a thermal pad on the board. For more information, see Texas Instruments literature number SLUA271 (www.ti.com/lit/slua271).

EXAMPLE STENCIL DESIGN

DQE0008A

X2SON - 0.4 mm max height

PLASTIC SMALL OUTLINE - NO LEAD



SOLDER PASTE EXAMPLE
BASED ON 0.075 MM THICK STENCIL
SCALE: 40X

4225204/A 08/2019

NOTES: (continued)

5. Laser cutting apertures with trapezoidal walls and rounded corners may offer better paste release. IPC-7525 may have alternate design recommendations.

YFP0008



PACKAGE OUTLINE

DSBGA - 0.5 mm max height

DIE SIZE BALL GRID ARRAY

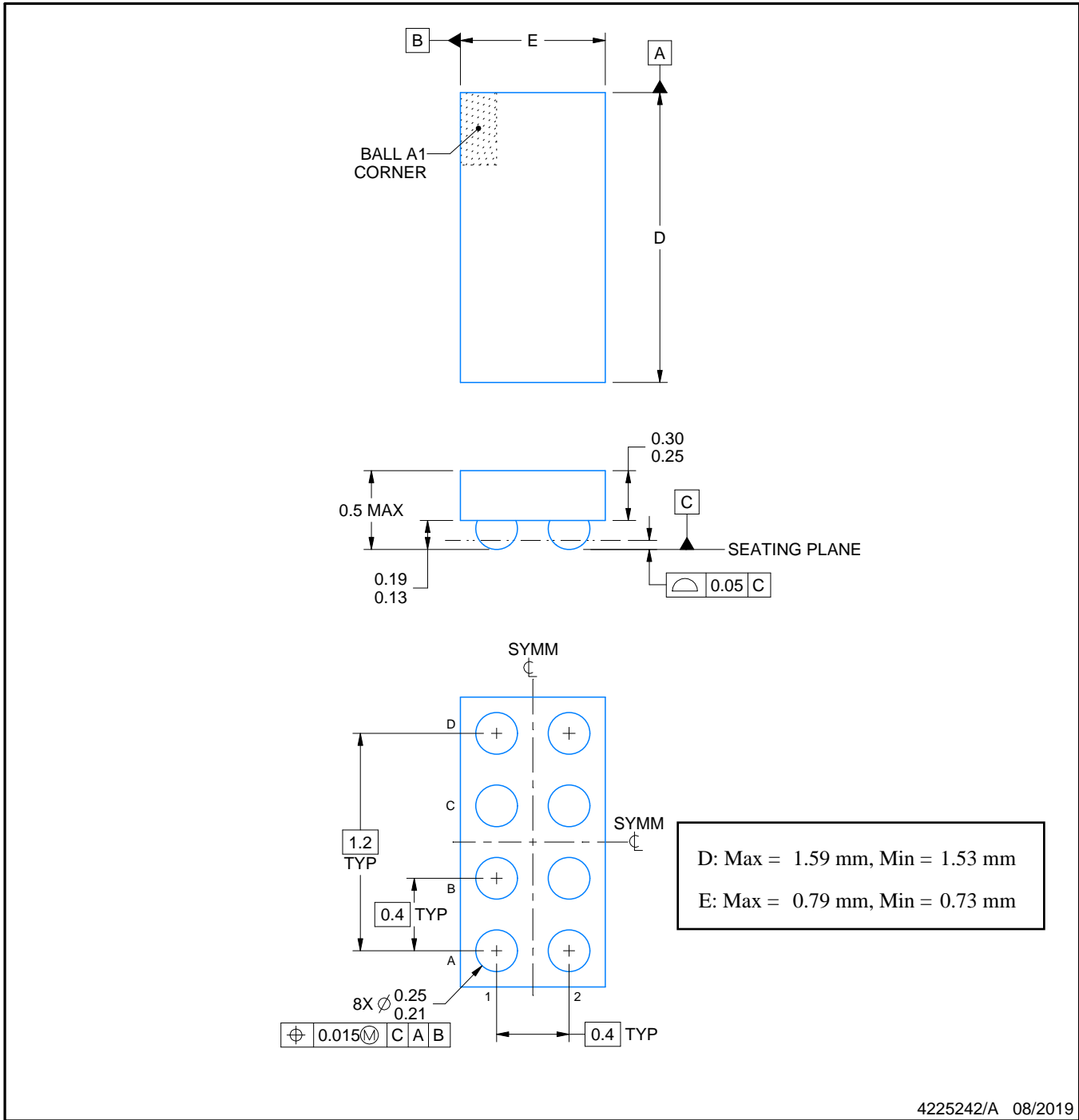

NOTES:

1. All linear dimensions are in millimeters. Any dimensions in parenthesis are for reference only. Dimensioning and tolerancing per ASME Y14.5M.
2. This drawing is subject to change without notice.

EXAMPLE BOARD LAYOUT

YFP0008

DSBGA - 0.5 mm max height

DIE SIZE BALL GRID ARRAY



LAND PATTERN EXAMPLE
EXPOSED METAL SHOWN
SCALE: 50X



SOLDER MASK DETAILS
NOT TO SCALE

4225242/A 08/2019

NOTES: (continued)

- Final dimensions may vary due to manufacturing tolerance considerations and also routing constraints. See Texas Instruments Literature No. SNVA009 (www.ti.com/lit/snva009).

EXAMPLE STENCIL DESIGN

YFP0008

DSBGA - 0.5 mm max height

DIE SIZE BALL GRID ARRAY

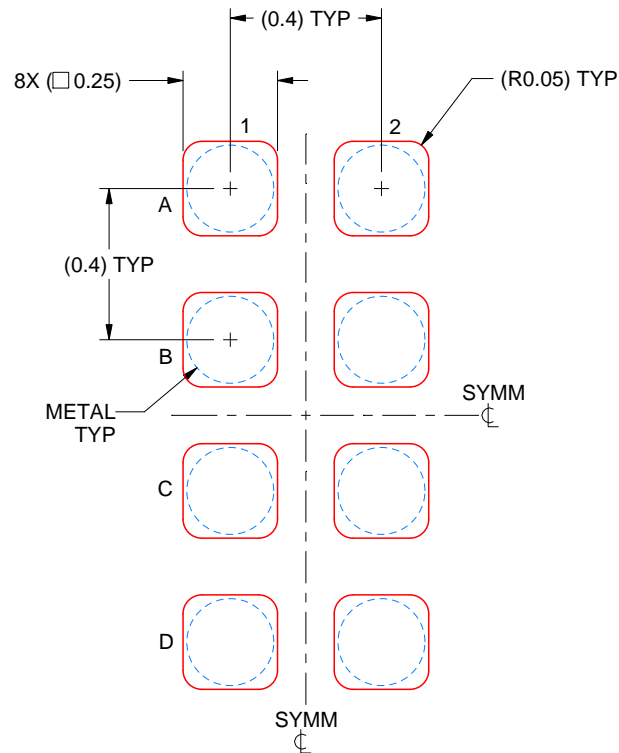

SOLDER PASTE EXAMPLE
BASED ON 0.1 mm THICK STENCIL
SCALE: 50X

4225242/A 08/2019

NOTES: (continued)

4. Laser cutting apertures with trapezoidal walls and rounded corners may offer better paste release.

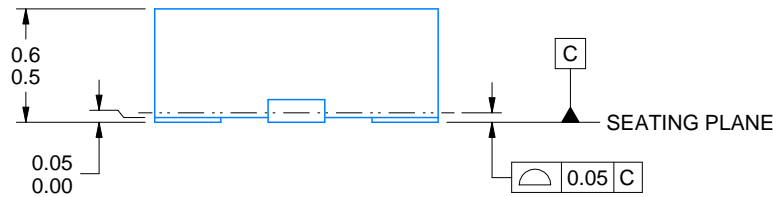

4220323/B 03/2018

NOTES:

1. All linear dimensions are in millimeters. Any dimensions in parenthesis are for reference only. Dimensioning and tolerancing per ASME Y14.5M.
2. This drawing is subject to change without notice.

EXAMPLE BOARD LAYOUT

RSE0008A

UQFN - 0.6 mm max height

PLASTIC QUAD FLATPACK - NO LEAD

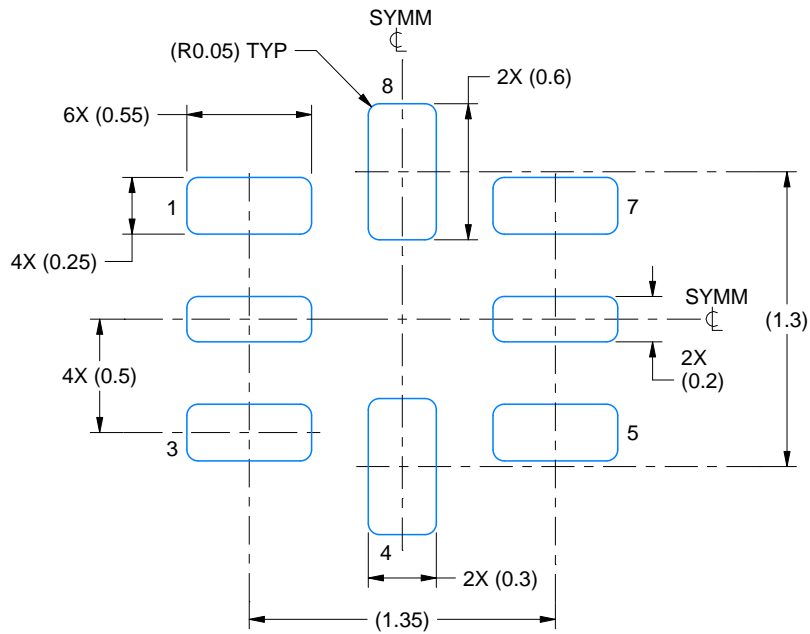

LAND PATTERN EXAMPLE
SCALE:30X

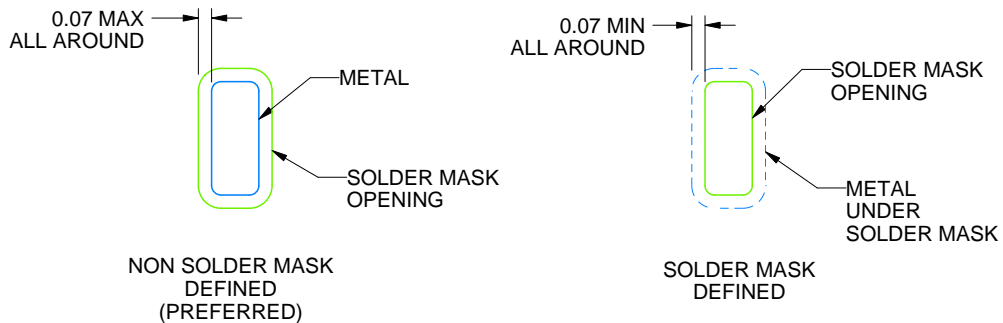

SOLDER MASK DETAILS
NOT TO SCALE

4220323/B 03/2018

NOTES: (continued)

3. For more information, see Texas Instruments literature number SLUA271 (www.ti.com/lit/slua271).

EXAMPLE STENCIL DESIGN

RSE0008A

UQFN - 0.6 mm max height

PLASTIC QUAD FLATPACK - NO LEAD



SOLDER PASTE EXAMPLE
BASED ON 0.1 mm THICKNESS
SCALE: 30X

4220323/B 03/2018

NOTES: (continued)

5. Laser cutting apertures with trapezoidal walls and rounded corners may offer better paste release. IPC-7525 may have alternate design recommendations.

IMPORTANT NOTICE AND DISCLAIMER

TI PROVIDES TECHNICAL AND RELIABILITY DATA (INCLUDING DATA SHEETS), DESIGN RESOURCES (INCLUDING REFERENCE DESIGNS), APPLICATION OR OTHER DESIGN ADVICE, WEB TOOLS, SAFETY INFORMATION, AND OTHER RESOURCES "AS IS" AND WITH ALL FAULTS, AND DISCLAIMS ALL WARRANTIES, EXPRESS AND IMPLIED, INCLUDING WITHOUT LIMITATION ANY IMPLIED WARRANTIES OF MERCHANTABILITY, FITNESS FOR A PARTICULAR PURPOSE OR NON-INFRINGEMENT OF THIRD PARTY INTELLECTUAL PROPERTY RIGHTS.

These resources are intended for skilled developers designing with TI products. You are solely responsible for (1) selecting the appropriate TI products for your application, (2) designing, validating and testing your application, and (3) ensuring your application meets applicable standards, and any other safety, security, regulatory or other requirements.

These resources are subject to change without notice. TI grants you permission to use these resources only for development of an application that uses the TI products described in the resource. Other reproduction and display of these resources is prohibited. No license is granted to any other TI intellectual property right or to any third party intellectual property right. TI disclaims responsibility for, and you will fully indemnify TI and its representatives against, any claims, damages, costs, losses, and liabilities arising out of your use of these resources.

TI's products are provided subject to [TI's Terms of Sale](#) or other applicable terms available either on ti.com or provided in conjunction with such TI products. TI's provision of these resources does not expand or otherwise alter TI's applicable warranties or warranty disclaimers for TI products.

TI objects to and rejects any additional or different terms you may have proposed.

Mailing Address: Texas Instruments, Post Office Box 655303, Dallas, Texas 75265
Copyright © 2022, Texas Instruments Incorporated