

SN74LVC1GU04 Single Inverter Gate

1 Features

- Available in the Texas Instruments NanoFree™ Package
- Supports 5-V V_{CC} Operation
- Inputs Accept Voltages to 5.5 V
- Unbuffered Output
- Maximum t_{pd} of 3.7 ns at 3.3 V
- Low Power Consumption, 10- μ A Maximum I_{CC}
- ± 24 -mA Output Drive at 3.3 V
- I_{off} Supports Live Insertion, Partial-Power-Down Mode, and Back-Drive Protection
- Latch-Up Performance Exceeds 100 mA Per JESD 78, Class II
- ESD Protection Exceeds JESD 22
 - 2000-V Human-Body Model (A114-A)
 - 200-V Machine Model (A115-A)
 - 1000-V Charged-Device Model (C101)

2 Applications

- AV Receivers
- Blu-ray Players and Home Theaters
- DVD Recorders and Players
- Desktop or Notebook PCs
- Digital Radio or Internet Radio Players
- Digital Video Cameras (DVC)
- Embedded PCs
- GPS: Personal Navigation Devices
- Mobile Internet Devices
- Network Projector Front-Ends
- Portable Media Players
- Pro Audio Mixers
- Smoke Detectors
- Solid-State Drive (SSD): Enterprise
- High-Definition (HDTV)
- Tablets: Enterprise
- Audio Docks: Portable
- DLP Front Projection Systems
- DVR and DVS
- Digital Picture Frame (DPF)
- Digital Still Cameras

3 Description

This single inverter gate is designed for 1.65-V to 5.5-V V_{CC} operation.

The SN74LVC1GU04 device contains one inverter with an unbuffered output and performs the Boolean function $Y = \bar{A}$.

NanoFree package technology is a major breakthrough in device packaging concepts, using the die as the package.

Device Information⁽¹⁾

PART NUMBER	PACKAGE	BODY SIZE (NOM)
SN74LVC1GU04DBV	SOT-23 (5)	2.90 mm x 1.60 mm
SN74LVC1GU04DCK	SC70 (5)	2.00 mm x 1.25 mm
SN74LVC1GU04DRL	SOT-5X3 (5)	1.60 mm x 1.20 mm
SN74LVC1GU04DRY	SON (6)	1.45 mm x 1.00 mm
SN74LVC1GU04DSF	SON (6)	1.00 mm x 1.00 mm
SN74LVC1GU04YZP	DSBGA (5)	1.44 mm x 0.94 mm
SN74LVC1GU04YZV	DSBGA (4)	0.91 mm x 0.91 mm
SN74LVC1GU04DPW	X2SON (5)	0.80 mm x 0.80 mm

(1) For all available packages, see the orderable addendum at the end of the data sheet.

Logic Diagram (Positive Logic)

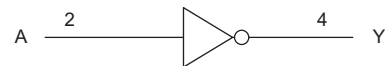


Table of Contents

1 Features	1	8.2 Functional Block Diagram	9
2 Applications	1	8.3 Feature Description	9
3 Description	1	8.4 Device Functional Modes	10
4 Revision History	2	9 Application and Implementation	11
5 Pin Configuration and Functions	3	9.1 Application Information	11
6 Specifications	5	9.2 Typical Application	11
6.1 Absolute Maximum Ratings	5	10 Power Supply Recommendations	12
6.2 ESD Ratings	5	11 Layout	13
6.3 Recommended Operating Conditions	5	11.1 Layout Guidelines	13
6.4 Thermal Information	6	11.2 Layout Example	13
6.5 Electrical Characteristics	6	12 Device and Documentation Support	14
6.6 Switching Characteristics: $T_A = -40^{\circ}\text{C}$ to $+85^{\circ}\text{C}$	7	12.1 Documentation Support	14
6.7 Switching Characteristics: $T_A = -40^{\circ}\text{C}$ to $+125^{\circ}\text{C}$	7	12.2 Community Resources	14
6.8 Operating Characteristics	7	12.3 Trademarks	14
6.9 Typical Characteristic	7	12.4 Electrostatic Discharge Caution	14
7 Parameter Measurement Information	8	12.5 Glossary	14
8 Detailed Description	9	13 Mechanical, Packaging, and Orderable Information	14
8.1 Overview	9		

4 Revision History

NOTE: Page numbers for previous revisions may differ from page numbers in the current version.

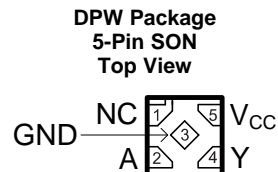
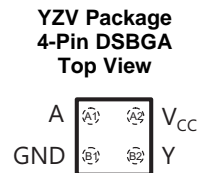
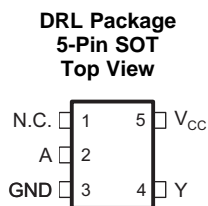
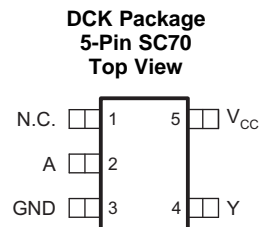
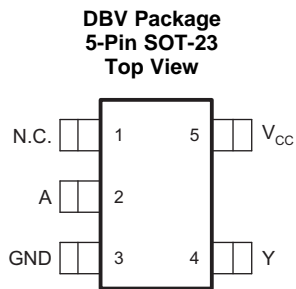
Changes from Revision X (November 2017) to Revision Y	Page
• Updated input voltage minimum from 0.5 V to –0.5 V in Absolute Maximum Ratings table	5

Changes from Revision W (January 2016) to Revision X	Page
• Changed values in the Thermal Information table to align with JEDEC standards	6
• Updated Feature Description to include more detailed information about specific device features.	9
• Changed Typical Application to oscillator circuit.	11
• Added DPW layout example	13

Changes from Revision V (November 2013) to Revision W	Page
• Added <i>Applications</i> section, <i>Device Information</i> table, <i>ESD Ratings</i> table, <i>Thermal Information</i> table, <i>Typical Characteristics</i> , <i>Feature Description</i> section, <i>Device Functional Modes</i> , <i>Application and Implementation</i> section, <i>Power Supply Recommendations</i> section, <i>Layout</i> section, <i>Device and Documentation Support</i> section, and <i>Mechanical, Packaging, and Orderable Information</i> section.	1

Changes from Revision U (June 2011) to Revision V	Page
• Updated document to new TI data sheet format	1
• Updated operating free-air temperature range in Recommended Operating Conditions table	5

5 Pin Configuration and Functions



Pin Functions⁽¹⁾⁽²⁾

NAME	PIN		I/O	DESCRIPTION
	DBV, DRL, DCK, DPW	YZV		
A	2	A1	I	Input
GND	3	B1	—	Ground
NC	1	—	—	Not connected
V _{CC}	5	A2	—	Positive Supply
Y	4	B2	O	Output

(1) NC – No internal connection

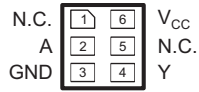
(2) See [Mechanical, Packaging, and Orderable Information](#) for dimensions

SN74LVC1GU04

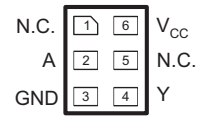
SCES215Y – APRIL 1999 – REVISED DECEMBER 2017

www.ti.com

DSF Package 6-Pin SON Top View



DRY Package 6-Pin SON Top View



YZP Package 6-Pin DSBGA Top View



DNU – Do not use

Pin Functions⁽¹⁾⁽²⁾

NAME	PIN		I/O	DESCRIPTION
	DSF, DRY	YZP		
A	2	B1	I	Input
GND	3	C1	—	Ground
NC	1, 5	A1, B2	—	Not connected
V _{CC}	6	A2	—	Positive Supply
Y	4	C2	O	Output

(1) NC – No internal connection

(2) See [Mechanical, Packaging, and Orderable Information](#) for dimensions

6 Specifications

6.1 Absolute Maximum Ratings

over operating free-air temperature range (unless otherwise noted)⁽¹⁾

		MIN	MAX	UNIT
V _{CC}	Supply voltage	-0.5	6.5	V
V _I	Input voltage ⁽²⁾	-0.5	6.5	V
V _O	Voltage applied to any output in the high or low state ⁽²⁾⁽³⁾	-0.5	V _{CC} + 0.5	V
I _{IK}	Input clamp current	V _I < 0		-50 mA
I _{OK}	Output clamp current	V _O < 0		-50 mA
I _O	Continuous output current		±50	mA
	Continuous current through V _{CC} or GND		±100	mA
T _J	Maximum junction temperature		150	°C
T _{stg}	Storage temperature	-65	150	°C

- (1) Stresses beyond those listed under *Absolute Maximum Ratings* may cause permanent damage to the device. These are stress ratings only, and functional operation of the device at these or any other conditions beyond those indicated under *Recommended Operating Conditions* is not implied. Exposure to absolute-maximum-rated conditions for extended periods may affect device reliability.
- (2) The input and output negative-voltage ratings may be exceeded if the input and output current ratings are observed.
- (3) The value of V_{CC} is provided in *Recommended Operating Conditions*.

6.2 ESD Ratings

		VALUE	UNIT
V _(ESD)	Electrostatic discharge	Human-body model (HBM), per ANSI/ESDA/JEDEC JS-001	±2000
		Charged-device model (CDM), per JEDEC specification JESD22-C101	±1000

6.3 Recommended Operating Conditions

See ⁽¹⁾.

		MIN	MAX	UNIT
V _{CC}	Supply voltage	1.65	5.5	V
V _{IH}	High-level input voltage	I _O = -100 μA		0.75 × V _{CC} V
V _{IL}	Low-level input voltage	I _O = 100 μA		0.25 × V _{CC} V
V _I	Input voltage	0	5.5	V
V _O	Output voltage	0	V _{CC}	V
I _{OH}	High-level output current	V _{CC} = 1.65 V		-4
		V _{CC} = 2.3 V		-8
		V _{CC} = 3 V		-16
		V _{CC} = 4.5 V		-24
		V _{CC} = 4.5 V		-32
I _{OL}	Low-level output current	V _{CC} = 1.65 V		4
		V _{CC} = 2.3 V		8
		V _{CC} = 3 V		16
		V _{CC} = 3 V		24
		V _{CC} = 4.5 V		32
T _A	Operating free-air temperature	-40	125	°C

- (1) All unused inputs of the device must be held at V_{CC} or GND to ensure proper device operation. For more information, see the *Implications of Slow or Floating CMOS Inputs application report*.

6.4 Thermal Information

THERMAL METRIC ⁽¹⁾	SN74LVC1GU04								UNIT
	DBV (SOT-23)	DCK (SC70)	DRL (SOT-5X3)	DRY (SON)	DSF (SON)	DPW (X2SON)	YZV (DSBGA)	YZP (DSBGA)	
	5 PINS	5 PINS	5 PINS	5 PINS	5 PINS	5 PINS	4 PINS	5 PINS	
$R_{\theta JA}$ Junction-to-ambient thermal resistance	231.5	276.1	296.2	369.6	410.3	511	168.2	144.4	°C/W
$R_{\theta JC(top)}$ Junction-to-case (top) thermal resistance	139.4	178.9	137.3	257.6	208.4	241.9	2.1	1.3	°C/W
$R_{\theta JB}$ Junction-to-board thermal resistance	71.1	70.9	145.3	230.8	262.6	374.2	55.9	39.9	°C/W
Ψ_{JT} Junction-to-top characterization parameter	45.2	47	14.7	77.2	36	45	1.1	0.5	°C/W
Ψ_{JB} Junction-to-board characterization parameter	70.7	69.3	145.9	231	262.3	373.3	56.3	39.7	°C/W
$R_{\theta JC(bot)}$ Junction-to-case (bottom) thermal resistance	N/A	N/A	N/A	N/A	N/A	168.0	N/A	N/A	°C/W

- (1) For more information about traditional and new thermal metrics, see the [Semiconductor and IC Package Thermal Metrics application report](#).

6.5 Electrical Characteristics

over recommended operating free-air temperature range, $T_A = -40^\circ\text{C}$ to $+125^\circ\text{C}$ (unless otherwise noted)

PARAMETER	TEST CONDITIONS	MIN	TYP ⁽¹⁾	MAX	UNIT
V_{OH} High-level output voltage	$V_{IL} = 0\text{ V}$, $I_{OH} = -100\ \mu\text{A}$, $V_{CC} = 1.65\text{ V to }5.5\text{ V}$	$V_{CC} - 0.1$			V
	$V_{IL} = 0\text{ V}$, $I_{OH} = -4\text{ mA}$, $V_{CC} = 1.65\text{ V}$	1.2			
	$V_{IL} = 0\text{ V}$, $I_{OH} = -8\text{ mA}$, $V_{CC} = 2.3\text{ V}$	1.9			
	$V_{IL} = 0\text{ V}$, $I_{OH} = -16\text{ mA}$, $V_{CC} = 3\text{ V}$	2.4			
	$V_{IL} = 0\text{ V}$, $I_{OH} = -24\text{ mA}$, $V_{CC} = 3\text{ V}$	2.3			
	$V_{IL} = 0\text{ V}$, $I_{OH} = -32\text{ mA}$, $V_{CC} = 4.5\text{ V}$	3.8			
V_{OL} Low-level output voltage	$V_{IH} = V_{CC}$, $I_{OL} = 100\ \mu\text{A}$, $V_{CC} = 1.65\text{ V to }5.5\text{ V}$	0.1			V
	$V_{IH} = V_{CC}$, $I_{OL} = 4\text{ mA}$, $V_{CC} = 1.65\text{ V}$	0.45			
	$V_{IH} = V_{CC}$, $I_{OL} = 8\text{ mA}$, $V_{CC} = 2.3\text{ V}$	0.3			
	$V_{IH} = V_{CC}$, $I_{OL} = 16\text{ mA}$, $V_{CC} = 3\text{ V}$	0.4			
	$V_{IH} = V_{CC}$, $I_{OL} = 24\text{ mA}$, $V_{CC} = 3\text{ V}$	0.55			
	$V_{IH} = V_{CC}$, $I_{OL} = 32\text{ mA}$, $V_{CC} = 4.5\text{ V}$	0.55			
I_I Input leakage current	A Input: $V_I = 5.5\text{ V or GND}$, $V_{CC} = 0\text{ V to }5.5\text{ V}$	± 5			μA
I_{CC} Supply current	$V_I = 5.5\text{ V or GND}$, $I_O = 0$, $V_{CC} = 1.65\text{ V to }5.5\text{ V}$	10			μA
C_I Input capacitance	$V_I = V_{CC}$ or GND, $V_{CC} = 3.3\text{ V}$, $T_A = -40^\circ\text{C to }85^\circ\text{C}$	7			pF

- (1) All typical values are at $V_{CC} = 3.3\text{ V}$, $T_A = 25^\circ\text{C}$.

6.6 Switching Characteristics: $T_A = -40^{\circ}\text{C}$ to $+85^{\circ}\text{C}$

 over recommended operating free-air temperature range (unless otherwise noted) (See [Figure 2](#))

PARAMETER	TEST CONDITIONS		MIN	MAX	UNIT
t_{pd} Propagation delay	A-to-Y	$V_{CC} = 1.8\text{ V} \pm 0.15\text{ V}$	1.3	5	ns
		$V_{CC} = 2.5\text{ V} \pm 0.2\text{ V}$	1	4	
		$V_{CC} = 3.3\text{ V} \pm 0.3\text{ V}$	1.1	3.7	
		$V_{CC} = 5\text{ V} \pm 0.5\text{ V}$	1	3	

6.7 Switching Characteristics: $T_A = -40^{\circ}\text{C}$ to $+125^{\circ}\text{C}$

 over recommended operating free-air temperature range (unless otherwise noted) (See [Figure 2](#))

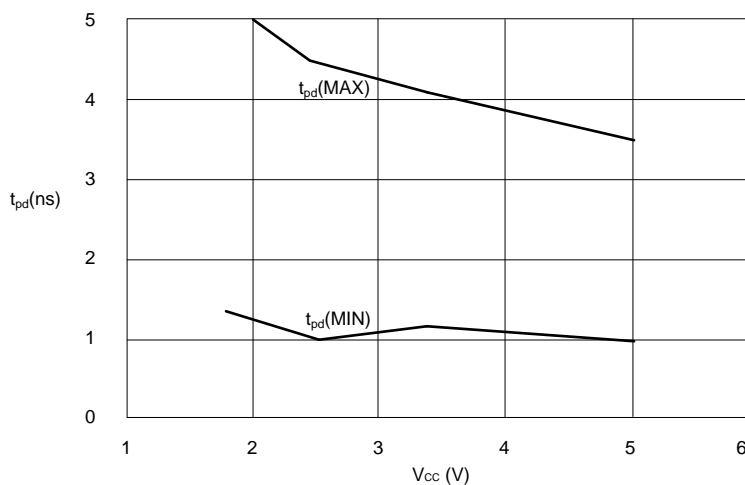
PARAMETER	TEST CONDITIONS		MIN	MAX	UNIT
t_{pd} Propagation delay	A-to-Y	$V_{CC} = 1.8\text{ V} \pm 0.15\text{ V}$	1.3	5.5	ns
		$V_{CC} = 2.5\text{ V} \pm 0.2\text{ V}$	1	4.5	
		$V_{CC} = 3.3\text{ V} \pm 0.3\text{ V}$	1.1	4.2	
		$V_{CC} = 5\text{ V} \pm 0.5\text{ V}$	1	3.5	

6.8 Operating Characteristics

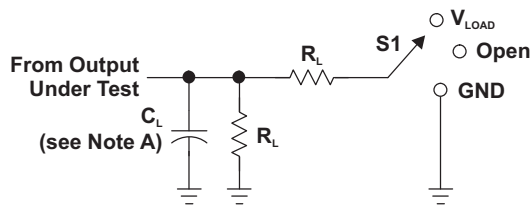
 $T_A = 25^{\circ}\text{C}$

PARAMETER	TEST CONDITIONS		TYP	UNIT
C_{pd} Power dissipation capacitance	$f = 10\text{ MHz}$	$V_{CC} = 1.8\text{ V}$	9	pF
		$V_{CC} = 2.5\text{ V}$	11	
		$V_{CC} = 3.3\text{ V}$	13	
		$V_{CC} = 5\text{ V}$	27	

6.9 Typical Characteristic

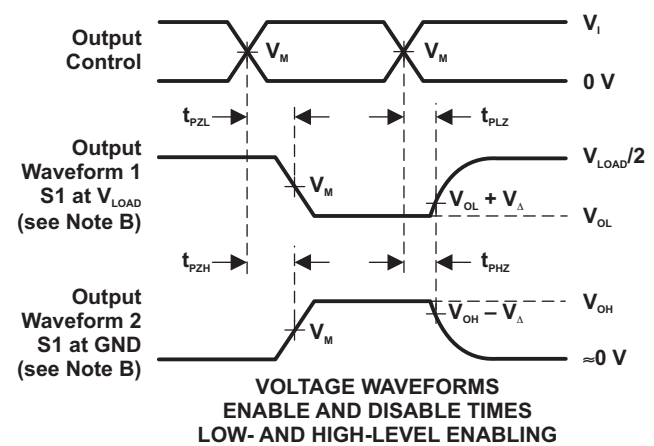
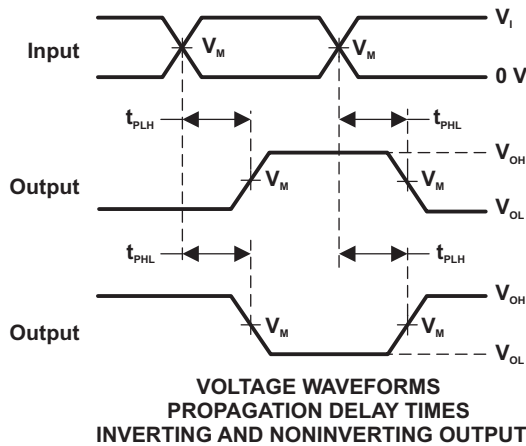
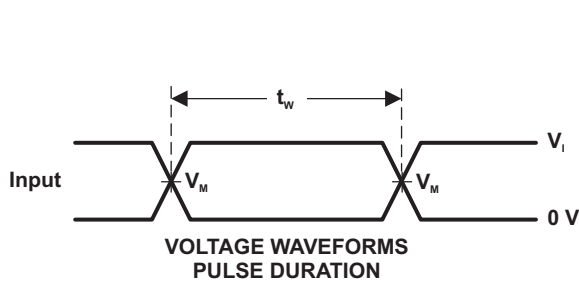

Figure 1. t_{pd} vs V_{CC}

7 Parameter Measurement Information


LOAD CIRCUIT

TEST	S1
t_{PLH}/t_{PHL}	Open
t_{PLZ}/t_{PZL}	V_{LOAD}
t_{PHZ}/t_{PZH}	GND

V_{CC}	INPUTS		V_M	V_{LOAD}	C_L	R_L	V_{Δ}
	V_i	t_r/t_f					
$1.8\text{ V} \pm 0.15\text{ V}$	V_{CC}	$\leq 2\text{ ns}$	$V_{CC}/2$	$2 \times V_{CC}$	30 pF	1 k Ω	0.15 V
$2.5\text{ V} \pm 0.2\text{ V}$	V_{CC}	$\leq 2\text{ ns}$	$V_{CC}/2$	$2 \times V_{CC}$	30 pF	500 Ω	0.15 V
$3.3\text{ V} \pm 0.3\text{ V}$	3 V	$\leq 2.5\text{ ns}$	1.5 V	6 V	50 pF	500 Ω	0.3 V
$5\text{ V} \pm 0.5\text{ V}$	V_{CC}	$\leq 2.5\text{ ns}$	$V_{CC}/2$	$2 \times V_{CC}$	50 pF	500 Ω	0.3 V



- NOTES:
- A. C_L includes probe and jig capacitance.
 - B. Waveform 1 is for an output with internal conditions such that the output is low, except when disabled by the output control. Waveform 2 is for an output with internal conditions such that the output is high, except when disabled by the output control.
 - C. All input pulses are supplied by generators having the following characteristics: $PRR \leq 10\text{ MHz}$, $Z_o = 50\ \Omega$.
 - D. The outputs are measured one at a time, with one transition per measurement.
 - E. t_{PLZ} and t_{PHZ} are the same as t_{dis} .
 - F. t_{PZL} and t_{PZH} are the same as t_{en} .
 - G. t_{PLH} and t_{PHL} are the same as t_{pd} .
 - H. All parameters and waveforms are not applicable to all devices.

Figure 2. Load Circuit and Voltage Waveforms

8 Detailed Description

8.1 Overview

The SN74LVC1GU04 device contains one inverter with an unbuffered output with a maximum sink current of 32 mA.

8.2 Functional Block Diagram

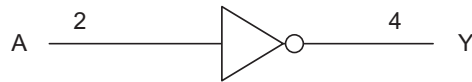


Figure 3. Logic Diagram (Positive Logic)

8.3 Feature Description

8.3.1 Balanced High-Drive CMOS Push-Pull Outputs

A balanced output allows the device to sink and source similar currents. The high-drive capability of this device creates fast edges into light loads, so routing and load conditions must be considered to prevent ringing. Additionally, the outputs of this device are capable of driving larger currents than the device can sustain without being damaged. It is important for the power output of the device to be limited to avoid thermal runaway and damage due to overcurrent. The electrical and thermal limits defined in the [Absolute Maximum Ratings](#) must be followed at all times.

8.3.2 Standard CMOS Inputs

Standard CMOS inputs are high impedance and are typically modeled as a resistor in parallel with the input capacitance given in the [Electrical Characteristics](#). The worst-case resistance is calculated with the maximum input voltage, given in the [Absolute Maximum Ratings](#), and the maximum input leakage current, given in the [Electrical Characteristics](#), using ohm's law ($R = V \div I$).

Signals that are applied to the inputs need to have fast edge rates, as shown by $\Delta t/\Delta v$ in the [Recommended Operating Conditions](#), to avoid excessive current consumption and oscillations. If a slow or noisy input signal is required, a device with a Schmitt-trigger input should be used to condition the input signal prior to the standard CMOS input.

8.3.3 Negative Clamping Diodes

The inputs and outputs to this device have negative clamping diodes as shown in [Figure 4](#).

CAUTION

Voltages beyond the values specified in the [Absolute Maximum Ratings](#) table can cause damage to the device. The input negative-voltage and output voltage ratings may be exceeded if the input and output clamp-current ratings are observed.

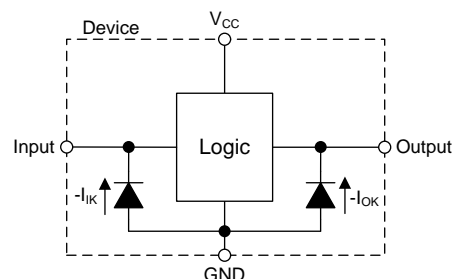


Figure 4. Electrical Placement of Clamping Diodes for Each Input and Output

Feature Description (continued)

8.3.4 Partial Power Down (I_{off})

The inputs and outputs for this device enter a high-impedance state when the supply voltage is 0 V. The maximum leakage into or out of any input or output pin on the device is specified by I_{off} in the [Electrical Characteristics](#).

8.3.5 Over-voltage Tolerant Inputs

Input signals to this device can be driven above the supply voltage so long as they remain below the maximum input voltage value specified in the [Recommended Operating Conditions](#).

8.3.6 Unbuffered Logic

A standard CMOS logic function typically consists of at least three stages: the input inverter, the logic function, and the output inverter. Some devices have multiple stages at the input or output for various reasons. An unbuffered CMOS logic function eliminates the extra input and output stages; the device only contains the required logic function which is directly driven from the inputs and directly drives the outputs.

The unbuffered inverter is commonly used in oscillator circuits because it is less sensitive to parameter changes in the oscillator circuit due to having lower total gain than a buffered equivalent. To learn more about how to use an unbuffered inverter in an oscillator circuit, see [Use of the CMOS Unbuffered Inverter in Oscillator Circuits](#).

8.4 Device Functional Modes

[Table 1](#) lists the functional modes of the SN74LVC1GU04.

Table 1. Function Table

INPUT A	OUTPUT Y
H	L
L	H

9 Application and Implementation

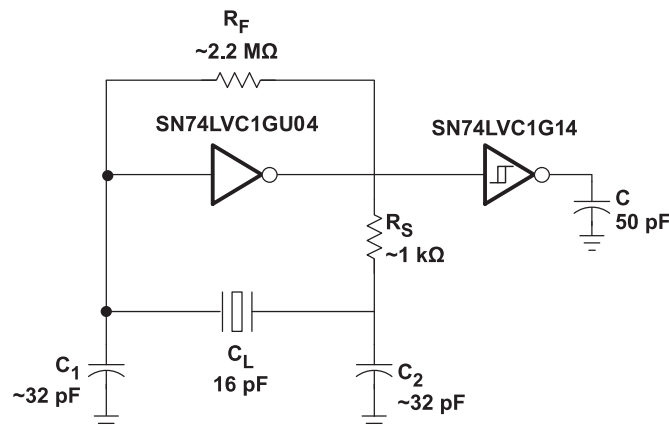
NOTE

Information in the following applications sections is not part of the TI component specification, and TI does not warrant its accuracy or completeness. TI's customers are responsible for determining suitability of components for their purposes. Customers should validate and test their design implementation to confirm system functionality.

9.1 Application Information

The unbuffered inverter is commonly used in oscillator circuits because it is less sensitive to parameter changes in the oscillator circuit due to having lower total gain than a buffered equivalent. An example application circuit is shown in [Figure 5](#). To learn more about how to use an unbuffered inverter in an oscillator circuit, refer to the [Use of the CMOS Unbuffered Inverter in Oscillator Circuits](#) application report.

9.2 Typical Application



Copyright © 2017, Texas Instruments Incorporated

Figure 5. Typical Application Diagram

9.2.1 Design Requirements

This device uses CMOS technology and has balanced output drive. Take care to avoid bus contention because it can drive currents that would exceed maximum limits. The high drive also creates fast edges into light loads, so routing and load conditions should be considered to prevent ringing.

9.2.2 Detailed Design Procedure

To learn more about how to use an unbuffered inverter in an oscillator circuit, refer to the [Use of the CMOS Unbuffered Inverter in Oscillator Circuits](#) application report.

1. Recommended Input Conditions

- Specified high and low levels. See (V_{IH} and V_{IL}) in [Recommended Operating Conditions](#).
- Inputs are overvoltage tolerant allowing them to go as high as (V_I max) in [Recommended Operating Conditions](#) at any valid V_{CC} .

2. Absolute Maximum Output Conditions

- Load currents must not exceed (I_O max) per output and must not exceed (Continuous current through V_{CC} or GND) total current for the part. These limits are located in [Absolute Maximum Ratings](#).
- Outputs must not be pulled above the voltage rated in the [Absolute Maximum Ratings](#).

Typical Application (continued)

9.2.3 Application Curve

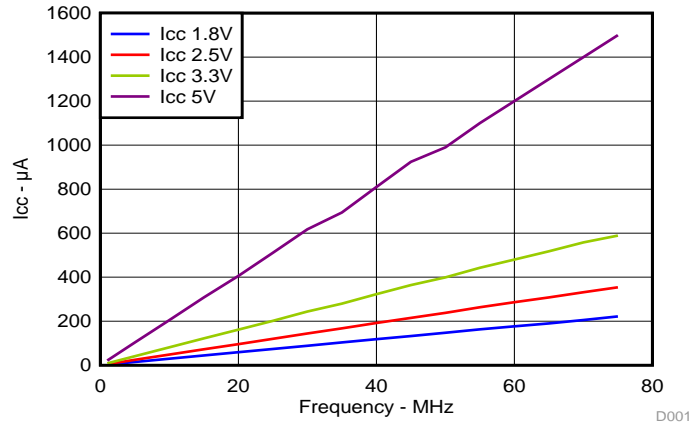


Figure 6. I_{CC} vs Frequency

10 Power Supply Recommendations

The power supply can be any voltage between the minimum and maximum supply voltage rating located in the [Recommended Operating Conditions](#) table.

The V_{CC} pin must have a good bypass capacitor to prevent power disturbance. A 0.1-µF capacitor is recommended, and it is ok to parallel multiple bypass caps to reject different frequencies of noise. 0.1-µF and 1-µF capacitors are commonly used in parallel. The bypass capacitor must be installed as close to the power pin as possible for best results.

11 Layout

11.1 Layout Guidelines

Even low data rate digital signals can contain high-frequency signal components due to fast edge rates. When a printed-circuit board (PCB) trace turns a corner at a 90° angle, a reflection can occur. A reflection occurs primarily because of the change of width of the trace. At the apex of the turn, the trace width increases to 1.414 times the width. This increase upsets the transmission-line characteristics, especially the distributed capacitance and self-inductance of the trace which results in the reflection. Not all PCB traces can be straight and therefore some traces must turn corners. Figure 7 shows progressively better techniques of rounding corners. Only the last example (BEST) maintains constant trace width and minimizes reflections.

An example layout is given in Figure 8 for the DPW (X2SON-5) package. This example layout includes a 0402 (metric) capacitor and uses the measurements found in the example board layout appended to this end of this datasheet. A via of diameter 0.1 mm (3.973 mil) is placed directly in the center of the device. This via can be used to trace out the center pin connection through another board layer, or it can be left out of the layout

11.2 Layout Example

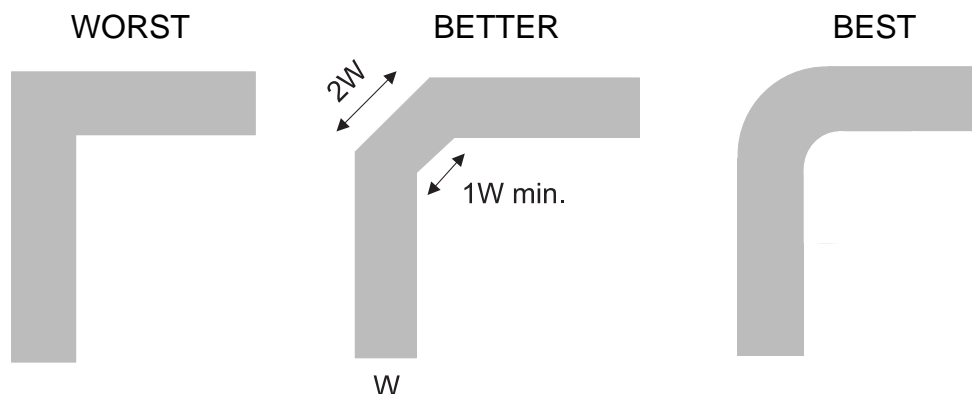


Figure 7. Trace Example

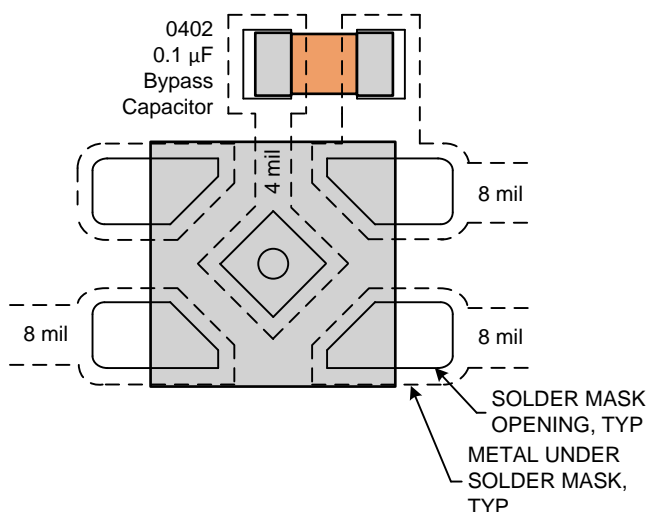


Figure 8. Example Layout With DPW (X2SON-5) Package

12 Device and Documentation Support

12.1 Documentation Support

12.1.1 Related Documentation

For related documentation, see the following:

Texas Instruments, [Implications of Slow or Floating CMOS Inputs application report](#)

12.2 Community Resources

The following links connect to TI community resources. Linked contents are provided "AS IS" by the respective contributors. They do not constitute TI specifications and do not necessarily reflect TI's views; see TI's [Terms of Use](#).

TI E2E™ Online Community *TI's Engineer-to-Engineer (E2E) Community*. Created to foster collaboration among engineers. At e2e.ti.com, you can ask questions, share knowledge, explore ideas and help solve problems with fellow engineers.

Design Support *TI's Design Support* Quickly find helpful E2E forums along with design support tools and contact information for technical support.

12.3 Trademarks

NanoFree, E2E are trademarks of Texas Instruments. All other trademarks are the property of their respective owners.

12.4 Electrostatic Discharge Caution



These devices have limited built-in ESD protection. The leads should be shorted together or the device placed in conductive foam during storage or handling to prevent electrostatic damage to the MOS gates.

12.5 Glossary

[SLYZ022](#) — *TI Glossary*.

This glossary lists and explains terms, acronyms, and definitions.

13 Mechanical, Packaging, and Orderable Information

The following pages include mechanical packaging and orderable information. This information is the most current data available for the designated devices. This data is subject to change without notice and revision of this document. For browser based versions of this data sheet, refer to the left hand navigation.

PACKAGING INFORMATION

Orderable Device	Status (1)	Package Type	Package Drawing	Pins	Package Qty	Eco Plan (2)	Lead finish/ Ball material (6)	MSL Peak Temp (3)	Op Temp (°C)	Device Marking (4/5)	Samples
74LVC1GU04DBVRE4	ACTIVE	SOT-23	DBV	5	3000	RoHS & Green	NIPDAU	Level-1-260C-UNLIM	-40 to 125	CU4F	Samples
74LVC1GU04DBVRG4	ACTIVE	SOT-23	DBV	5	3000	RoHS & Green	NIPDAU	Level-1-260C-UNLIM	-40 to 125	CU4F	Samples
74LVC1GU04DBVTG4	ACTIVE	SOT-23	DBV	5	250	RoHS & Green	NIPDAU	Level-1-260C-UNLIM	-40 to 125	CU4F	Samples
74LVC1GU04DCKRE4	ACTIVE	SC70	DCK	5	3000	RoHS & Green	NIPDAU	Level-1-260C-UNLIM	-40 to 125	CD5 CDS	Samples
74LVC1GU04DCKRG4	ACTIVE	SC70	DCK	5	3000	RoHS & Green	NIPDAU	Level-1-260C-UNLIM	-40 to 125	CD5 CDS	Samples
74LVC1GU04DCKTE4	ACTIVE	SC70	DCK	5	250	TBD	Call TI	Call TI	-40 to 125		Samples
74LVC1GU04DCKTG4	ACTIVE	SC70	DCK	5	250	RoHS & Green	NIPDAU	Level-1-260C-UNLIM	-40 to 125	CD5 CDS	Samples
74LVC1GU04DRLRG4	ACTIVE	SOT-5X3	DRL	5	4000	RoHS & Green	NIPDAUAG	Level-1-260C-UNLIM	-40 to 125	CDR	Samples
SN74LVC1GU04DBVR	ACTIVE	SOT-23	DBV	5	3000	RoHS & Green	NIPDAU SN	Level-1-260C-UNLIM	-40 to 125	(CU45, CU4F, CU4J, CU4R, CU4T) (CU4H, CU4P, CU4S)	Samples
SN74LVC1GU04DBVT	ACTIVE	SOT-23	DBV	5	250	RoHS & Green	NIPDAU SN	Level-1-260C-UNLIM	-40 to 125	(CU45, CU4F, CU4J, CU4R) (CU4H, CU4P, CU4S)	Samples
SN74LVC1GU04DCKR	ACTIVE	SC70	DCK	5	3000	RoHS & Green	NIPDAU SN	Level-1-260C-UNLIM	-40 to 125	(CD5, CDF, CDJ, CD K, CDR, CDT) (CDH, CDP, CDS)	Samples
SN74LVC1GU04DCKT	ACTIVE	SC70	DCK	5	250	RoHS & Green	NIPDAU SN	Level-1-260C-UNLIM	-40 to 125	(CD5, CDF, CDJ, CD K, CDR, CDT) (CDH, CDP, CDS)	Samples
SN74LVC1GU04DPWR	ACTIVE	X2SON	DPW	5	3000	RoHS & Green	NIPDAU	Level-1-260C-UNLIM	-40 to 85	CM	Samples
SN74LVC1GU04DRLR	ACTIVE	SOT-5X3	DRL	5	4000	RoHS & Green	NIPDAUAG	Level-1-260C-UNLIM	-40 to 125	CDR	Samples
SN74LVC1GU04DRY2	ACTIVE	SON	DRY	6	5000	RoHS & Green	NIPDAU NIPDAUAG	Level-1-260C-UNLIM	-40 to 125	CD	Samples

Orderable Device	Status (1)	Package Type	Package Drawing	Pins	Package Qty	Eco Plan (2)	Lead finish/ Ball material (6)	MSL Peak Temp (3)	Op Temp (°C)	Device Marking (4/5)	Samples
SN74LVC1GU04DRYR	ACTIVE	SON	DRY	6	5000	RoHS & Green	NIPDAU NIPDAUAG	Level-1-260C-UNLIM	-40 to 125	CD	Samples
SN74LVC1GU04DSFR	ACTIVE	SON	DSF	6	5000	RoHS & Green	NIPDAU NIPDAUAG	Level-1-260C-UNLIM	-40 to 125	CD	Samples
SN74LVC1GU04YZPR	ACTIVE	DSBGA	YZP	5	3000	RoHS & Green	SNAGCU	Level-1-260C-UNLIM	-40 to 85	CDN	Samples
SN74LVC1GU04YZVR	ACTIVE	DSBGA	YZV	4	3000	RoHS & Green	SNAGCU	Level-1-260C-UNLIM	-40 to 85	CD (7, N)	Samples

(1) The marketing status values are defined as follows:

ACTIVE: Product device recommended for new designs.

LIFEBUY: TI has announced that the device will be discontinued, and a lifetime-buy period is in effect.

NRND: Not recommended for new designs. Device is in production to support existing customers, but TI does not recommend using this part in a new design.

PREVIEW: Device has been announced but is not in production. Samples may or may not be available.

OBsolete: TI has discontinued the production of the device.

(2) **RoHS:** TI defines "RoHS" to mean semiconductor products that are compliant with the current EU RoHS requirements for all 10 RoHS substances, including the requirement that RoHS substance do not exceed 0.1% by weight in homogeneous materials. Where designed to be soldered at high temperatures, "RoHS" products are suitable for use in specified lead-free processes. TI may reference these types of products as "Pb-Free".

RoHS Exempt: TI defines "RoHS Exempt" to mean products that contain lead but are compliant with EU RoHS pursuant to a specific EU RoHS exemption.

Green: TI defines "Green" to mean the content of Chlorine (Cl) and Bromine (Br) based flame retardants meet JS709B low halogen requirements of <=1000ppm threshold. Antimony trioxide based flame retardants must also meet the <=1000ppm threshold requirement.

(3) MSL, Peak Temp. - The Moisture Sensitivity Level rating according to the JEDEC industry standard classifications, and peak solder temperature.

(4) There may be additional marking, which relates to the logo, the lot trace code information, or the environmental category on the device.

(5) Multiple Device Markings will be inside parentheses. Only one Device Marking contained in parentheses and separated by a "-" will appear on a device. If a line is indented then it is a continuation of the previous line and the two combined represent the entire Device Marking for that device.

(6) Lead finish/Ball material - Orderable Devices may have multiple material finish options. Finish options are separated by a vertical ruled line. Lead finish/Ball material values may wrap to two lines if the finish value exceeds the maximum column width.

Important Information and Disclaimer:The information provided on this page represents TI's knowledge and belief as of the date that it is provided. TI bases its knowledge and belief on information provided by third parties, and makes no representation or warranty as to the accuracy of such information. Efforts are underway to better integrate information from third parties. TI has taken and continues to take reasonable steps to provide representative and accurate information but may not have conducted destructive testing or chemical analysis on incoming materials and chemicals. TI and TI suppliers consider certain information to be proprietary, and thus CAS numbers and other limited information may not be available for release.

In no event shall TI's liability arising out of such information exceed the total purchase price of the TI part(s) at issue in this document sold by TI to Customer on an annual basis.

TAPE AND REEL INFORMATION



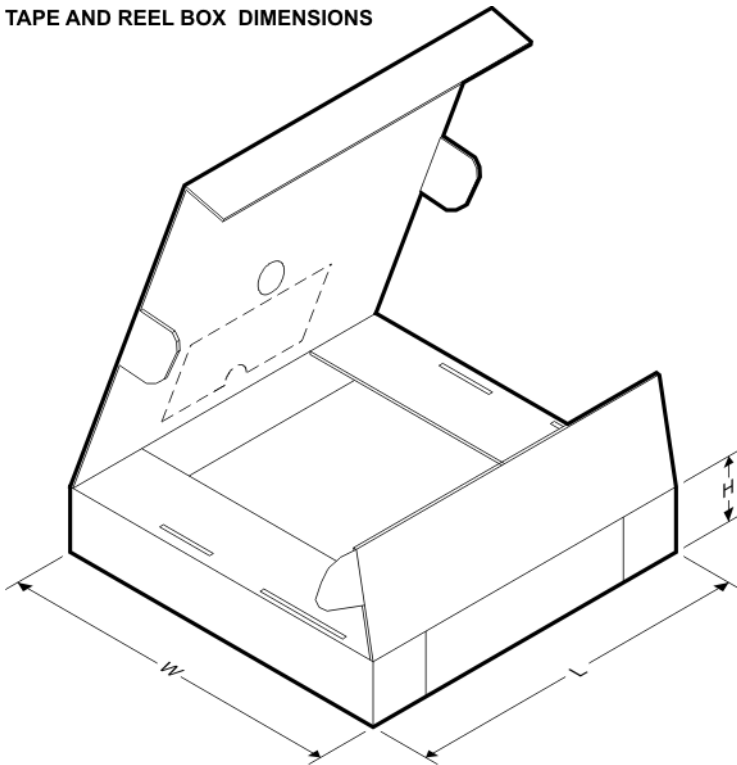
QUADRANT ASSIGNMENTS FOR PIN 1 ORIENTATION IN TAPE



*All dimensions are nominal

Device	Package Type	Package Drawing	Pins	SPQ	Reel Diameter (mm)	Reel Width W1 (mm)	A0 (mm)	B0 (mm)	K0 (mm)	P1 (mm)	W (mm)	Pin1 Quadrant
74LVC1GU04DBVRG4	SOT-23	DBV	5	3000	178.0	9.0	3.23	3.17	1.37	4.0	8.0	Q3
74LVC1GU04DBVTG4	SOT-23	DBV	5	250	178.0	9.0	3.23	3.17	1.37	4.0	8.0	Q3
74LVC1GU04DCKRG4	SC70	DCK	5	3000	178.0	9.2	2.4	2.4	1.22	4.0	8.0	Q3
74LVC1GU04DCKTG4	SC70	DCK	5	250	178.0	9.2	2.4	2.4	1.22	4.0	8.0	Q3
SN74LVC1GU04DBVR	SOT-23	DBV	5	3000	178.0	9.0	3.23	3.17	1.37	4.0	8.0	Q3
SN74LVC1GU04DBVR	SOT-23	DBV	5	3000	180.0	8.4	3.23	3.17	1.37	4.0	8.0	Q3
SN74LVC1GU04DBVR	SOT-23	DBV	5	3000	178.0	9.2	3.3	3.23	1.55	4.0	8.0	Q3
SN74LVC1GU04DBVR	SOT-23	DBV	5	3000	178.0	9.0	3.3	3.2	1.4	4.0	8.0	Q3
SN74LVC1GU04DBVT	SOT-23	DBV	5	250	180.0	8.4	3.23	3.17	1.37	4.0	8.0	Q3
SN74LVC1GU04DBVT	SOT-23	DBV	5	250	178.0	9.0	3.3	3.2	1.4	4.0	8.0	Q3
SN74LVC1GU04DBVT	SOT-23	DBV	5	250	178.0	9.2	3.3	3.23	1.55	4.0	8.0	Q3
SN74LVC1GU04DBVT	SOT-23	DBV	5	250	178.0	9.0	3.23	3.17	1.37	4.0	8.0	Q3
SN74LVC1GU04DCKR	SC70	DCK	5	3000	178.0	9.2	2.4	2.4	1.22	4.0	8.0	Q3
SN74LVC1GU04DCKR	SC70	DCK	5	3000	178.0	9.0	2.4	2.5	1.2	4.0	8.0	Q3
SN74LVC1GU04DCKR	SC70	DCK	5	3000	180.0	8.4	2.47	2.3	1.25	4.0	8.0	Q3
SN74LVC1GU04DCKT	SC70	DCK	5	250	178.0	9.0	2.4	2.5	1.2	4.0	8.0	Q3
SN74LVC1GU04DCKT	SC70	DCK	5	250	178.0	9.2	2.4	2.4	1.22	4.0	8.0	Q3
SN74LVC1GU04DPWR	X2SON	DPW	5	3000	178.0	8.4	0.91	0.91	0.5	2.0	8.0	Q3

Device	Package Type	Package Drawing	Pins	SPQ	Reel Diameter (mm)	Reel Width W1 (mm)	A0 (mm)	B0 (mm)	K0 (mm)	P1 (mm)	W (mm)	Pin1 Quadrant
SN74LVC1GU04DRLR	SOT-5X3	DRL	5	4000	180.0	8.4	1.98	1.78	0.69	4.0	8.0	Q3
SN74LVC1GU04DRY2	SON	DRY	6	5000	180.0	8.4	1.65	1.2	0.7	4.0	8.0	Q3
SN74LVC1GU04DRY2	SON	DRY	6	5000	180.0	9.5	1.6	1.15	0.75	4.0	8.0	Q3
SN74LVC1GU04DRYR	SON	DRY	6	5000	180.0	9.5	1.15	1.6	0.75	4.0	8.0	Q1
SN74LVC1GU04DSFR	SON	DSF	6	5000	180.0	9.5	1.16	1.16	0.5	4.0	8.0	Q2
SN74LVC1GU04YZPR	DSBGA	YZP	5	3000	178.0	9.2	1.02	1.52	0.63	4.0	8.0	Q1
SN74LVC1GU04YZVR	DSBGA	YZV	4	3000	178.0	9.2	1.0	1.0	0.63	4.0	8.0	Q1

TAPE AND REEL BOX DIMENSIONS


*All dimensions are nominal

Device	Package Type	Package Drawing	Pins	SPQ	Length (mm)	Width (mm)	Height (mm)
74LVC1GU04DBVRG4	SOT-23	DBV	5	3000	180.0	180.0	18.0
74LVC1GU04DBVTG4	SOT-23	DBV	5	250	180.0	180.0	18.0
74LVC1GU04DCKRG4	SC70	DCK	5	3000	180.0	180.0	18.0
74LVC1GU04DCKTG4	SC70	DCK	5	250	180.0	180.0	18.0
SN74LVC1GU04DBVR	SOT-23	DBV	5	3000	180.0	180.0	18.0
SN74LVC1GU04DBVR	SOT-23	DBV	5	3000	202.0	201.0	28.0
SN74LVC1GU04DBVR	SOT-23	DBV	5	3000	180.0	180.0	18.0
SN74LVC1GU04DBVR	SOT-23	DBV	5	3000	180.0	180.0	18.0
SN74LVC1GU04DBVT	SOT-23	DBV	5	250	202.0	201.0	28.0
SN74LVC1GU04DBVT	SOT-23	DBV	5	250	180.0	180.0	18.0

Device	Package Type	Package Drawing	Pins	SPQ	Length (mm)	Width (mm)	Height (mm)
SN74LVC1GU04DBVT	SOT-23	DBV	5	250	180.0	180.0	18.0
SN74LVC1GU04DBVT	SOT-23	DBV	5	250	180.0	180.0	18.0
SN74LVC1GU04DCKR	SC70	DCK	5	3000	180.0	180.0	18.0
SN74LVC1GU04DCKR	SC70	DCK	5	3000	180.0	180.0	18.0
SN74LVC1GU04DCKR	SC70	DCK	5	3000	202.0	201.0	28.0
SN74LVC1GU04DCKT	SC70	DCK	5	250	180.0	180.0	18.0
SN74LVC1GU04DCKT	SC70	DCK	5	250	180.0	180.0	18.0
SN74LVC1GU04DPWR	X2SON	DPW	5	3000	205.0	200.0	33.0
SN74LVC1GU04DRLR	SOT-5X3	DRL	5	4000	202.0	201.0	28.0
SN74LVC1GU04DRY2	SON	DRY	6	5000	202.0	201.0	28.0
SN74LVC1GU04DRY2	SON	DRY	6	5000	184.0	184.0	19.0
SN74LVC1GU04DRYR	SON	DRY	6	5000	184.0	184.0	19.0
SN74LVC1GU04DSFR	SON	DSF	6	5000	184.0	184.0	19.0
SN74LVC1GU04YZPR	DSBGA	YZP	5	3000	220.0	220.0	35.0
SN74LVC1GU04YZVR	DSBGA	YZV	4	3000	220.0	220.0	35.0

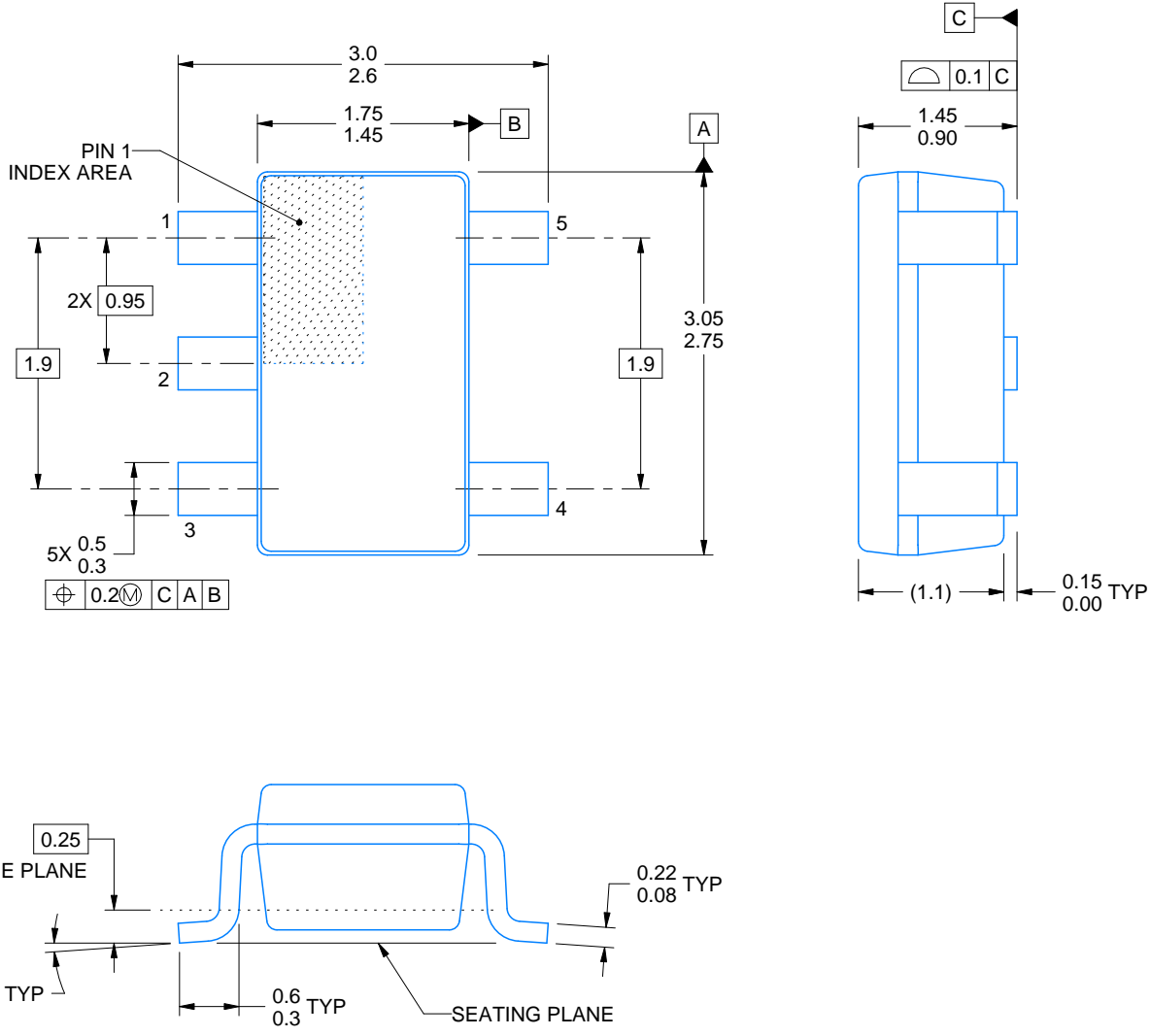
DBV0005A



PACKAGE OUTLINE

SOT-23 - 1.45 mm max height

SMALL OUTLINE TRANSISTOR



4214839/F 06/2021

NOTES:

- 1. All linear dimensions are in millimeters. Any dimensions in parenthesis are for reference only. Dimensioning and tolerancing per ASME Y14.5M.
- 2. This drawing is subject to change without notice.
- 3. Reference JEDEC MO-178.
- 4. Body dimensions do not include mold flash, protrusions, or gate burrs. Mold flash, protrusions, or gate burrs shall not exceed 0.25 mm per side.

EXAMPLE BOARD LAYOUT

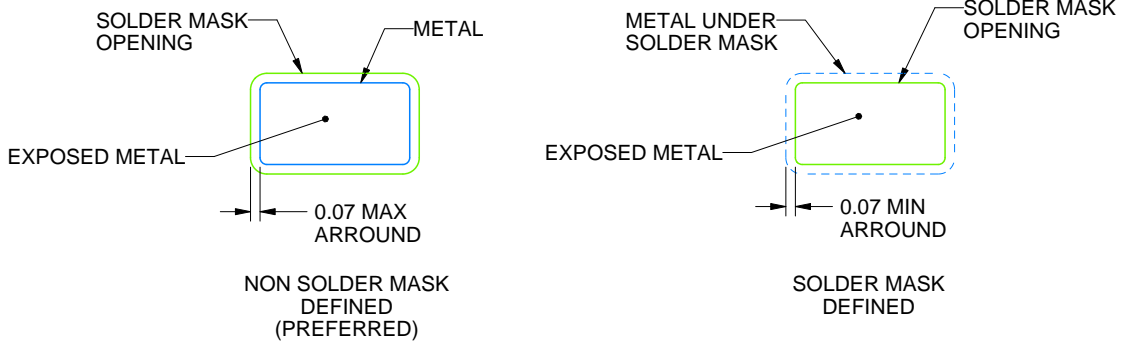
DBV0005A

SOT-23 - 1.45 mm max height

SMALL OUTLINE TRANSISTOR



LAND PATTERN EXAMPLE
EXPOSED METAL SHOWN
SCALE:15X



SOLDER MASK DETAILS

4214839/F 06/2021

NOTES: (continued)

- Publication IPC-7351 may have alternate designs.
- Solder mask tolerances between and around signal pads can vary based on board fabrication site.

EXAMPLE STENCIL DESIGN

DBV0005A

SOT-23 - 1.45 mm max height

SMALL OUTLINE TRANSISTOR



SOLDER PASTE EXAMPLE
BASED ON 0.125 mm THICK STENCIL
SCALE:15X

4214839/F 06/2021

NOTES: (continued)

7. Laser cutting apertures with trapezoidal walls and rounded corners may offer better paste release. IPC-7525 may have alternate design recommendations.
8. Board assembly site may have different recommendations for stencil design.

GENERIC PACKAGE VIEW

DPW 5

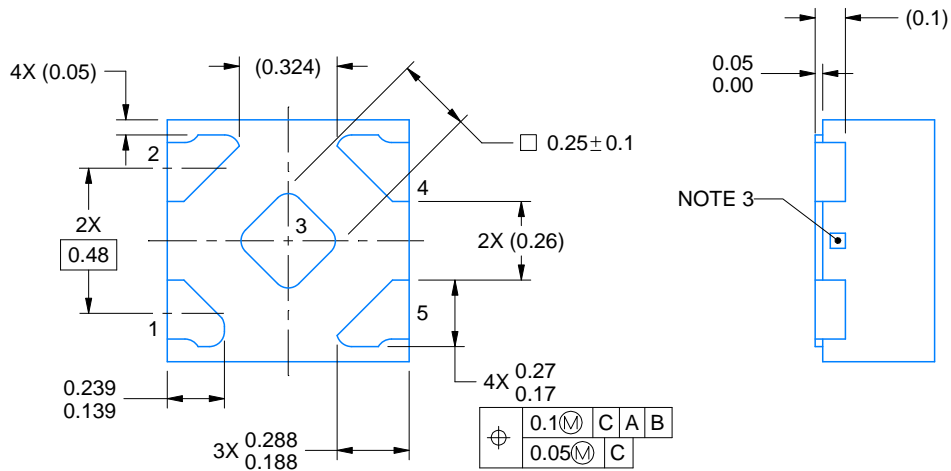
X2SON - 0.4 mm max height

PLASTIC SMALL OUTLINE - NO LEAD



Images above are just a representation of the package family, actual package may vary.
Refer to the product data sheet for package details.

4211218-3/D



4223102/D 03/2022

NOTES:

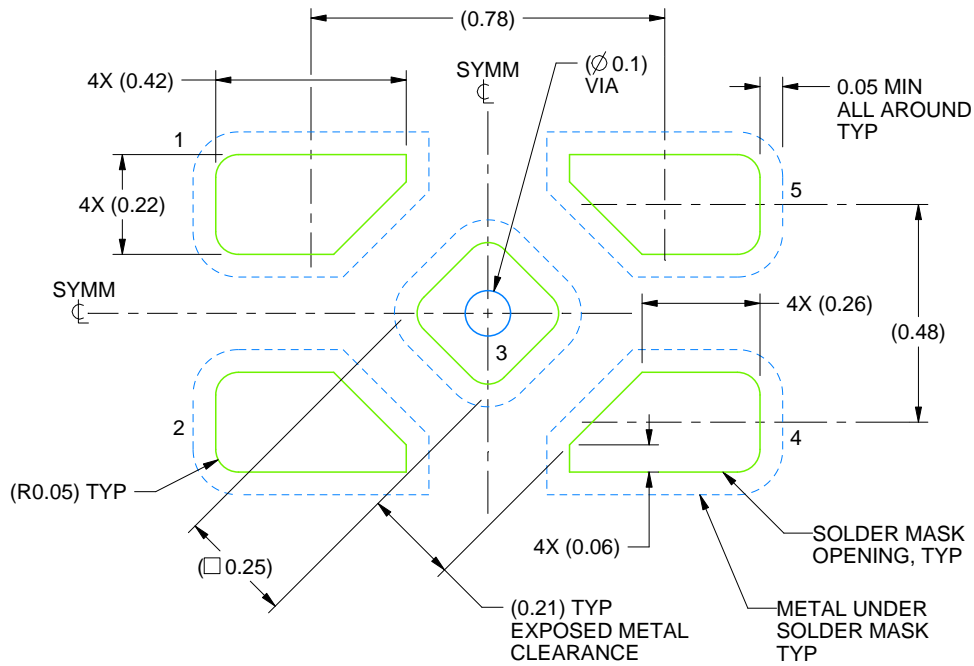
1. All linear dimensions are in millimeters. Any dimensions in parenthesis are for reference only. Dimensioning and tolerancing per ASME Y14.5M.
2. This drawing is subject to change without notice.
3. The size and shape of this feature may vary.

EXAMPLE BOARD LAYOUT

DPW0005A

X2SON - 0.4 mm max height

PLASTIC SMALL OUTLINE - NO LEAD



LAND PATTERN EXAMPLE
SOLDER MASK DEFINED
SCALE:60X

4223102/D 03/2022

NOTES: (continued)

4. This package is designed to be soldered to a thermal pad on the board. For more information, refer to QFN/SON PCB application note in literature No. SLUA271 (www.ti.com/lit/slua271).

EXAMPLE STENCIL DESIGN

DPW0005A

X2SON - 0.4 mm max height

PLASTIC SMALL OUTLINE - NO LEAD



SOLDER PASTE EXAMPLE
BASED ON 0.1 mm THICK STENCIL

EXPOSED PAD 3
92% PRINTED SOLDER COVERAGE BY AREA UNDER PACKAGE
SCALE:100X

4223102/D 03/2022

NOTES: (continued)

5. Laser cutting apertures with trapezoidal walls and rounded corners may offer better paste release. IPC-7525 may have alternate design recommendations.

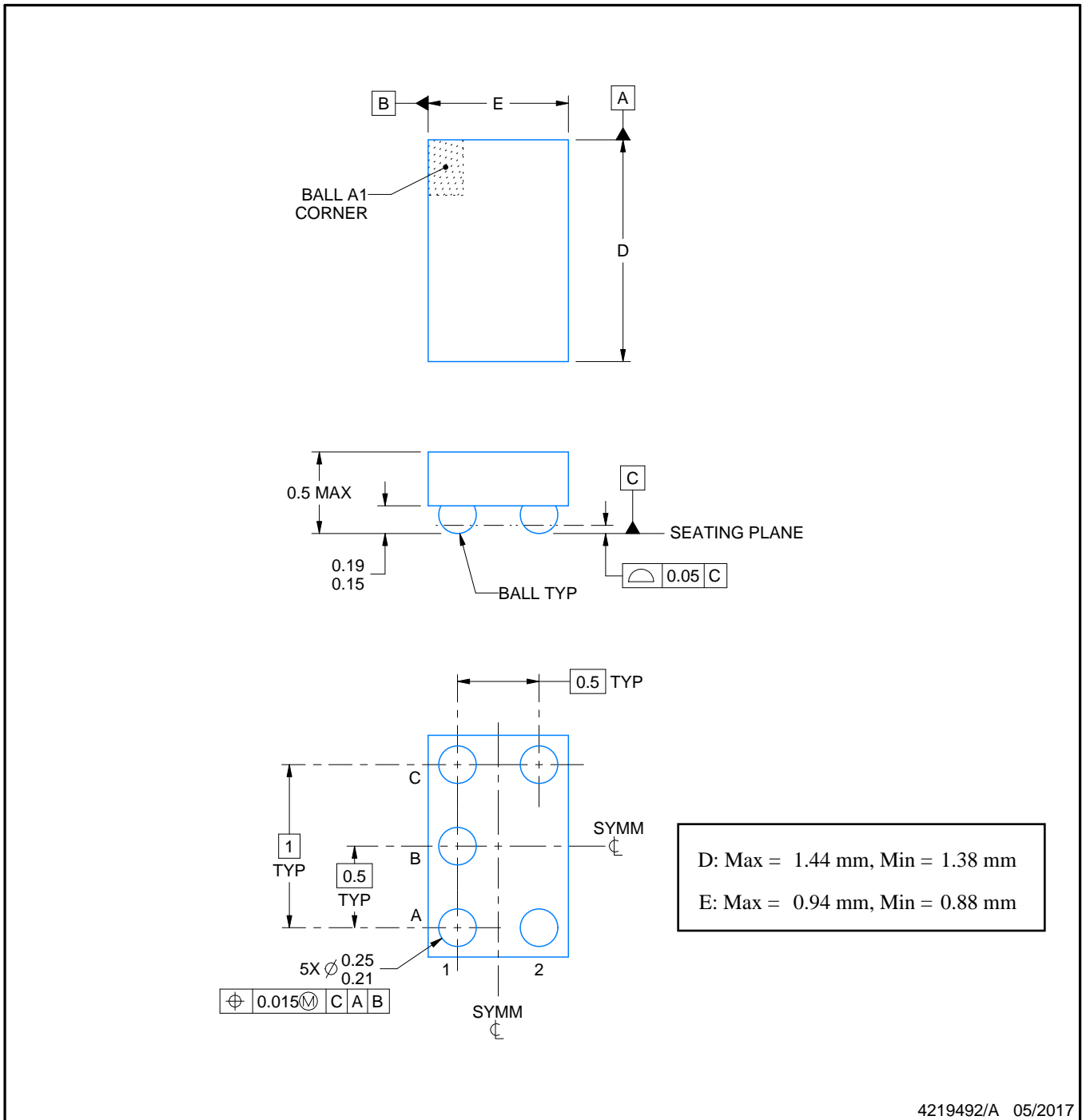
YZP0005



PACKAGE OUTLINE

DSBGA - 0.5 mm max height

DIE SIZE BALL GRID ARRAY



4219492/A 05/2017

NOTES:

- 1. All linear dimensions are in millimeters. Any dimensions in parenthesis are for reference only. Dimensioning and tolerancing per ASME Y14.5M.
- 2. This drawing is subject to change without notice.

EXAMPLE BOARD LAYOUT

YZP0005

DSBGA - 0.5 mm max height

DIE SIZE BALL GRID ARRAY



LAND PATTERN EXAMPLE
SCALE:40X



SOLDER MASK DETAILS
NOT TO SCALE

4219492/A 05/2017

NOTES: (continued)

- Final dimensions may vary due to manufacturing tolerance considerations and also routing constraints. For more information, see Texas Instruments literature number SNVA009 (www.ti.com/lit/snva009).

EXAMPLE STENCIL DESIGN

YZP0005

DSBGA - 0.5 mm max height

DIE SIZE BALL GRID ARRAY



SOLDER PASTE EXAMPLE
BASED ON 0.1 mm THICK STENCIL
SCALE:40X

4219492/A 05/2017

NOTES: (continued)

4. Laser cutting apertures with trapezoidal walls and rounded corners may offer better paste release.

YZV (S-XBGA-N4)

DIE-SIZE BALL GRID ARRAY



- NOTES:
- A. All linear dimensions are in millimeters. Dimensioning and tolerancing per ASME Y14.5M-1994.
 - B. This drawing is subject to change without notice.
 - C. NanoFree™ package configuration.

NanoFree is a trademark of Texas Instruments.

DRL0005A



PACKAGE OUTLINE

SOT - 0.6 mm max height

PLASTIC SMALL OUTLINE



4220753/B 12/2020

NOTES:

1. All linear dimensions are in millimeters. Any dimensions in parenthesis are for reference only. Dimensioning and tolerancing per ASME Y14.5M.
2. This drawing is subject to change without notice.
3. This dimension does not include mold flash, protrusions, or gate burrs. Mold flash, protrusions, or gate burrs shall not exceed 0.15 mm per side.
4. Reference JEDEC registration MO-293 Variation UAAD-1

EXAMPLE BOARD LAYOUT

DRL0005A

SOT - 0.6 mm max height

PLASTIC SMALL OUTLINE



LAND PATTERN EXAMPLE
SCALE:30X



SOLDERMASK DETAILS

4220753/B 12/2020

NOTES: (continued)

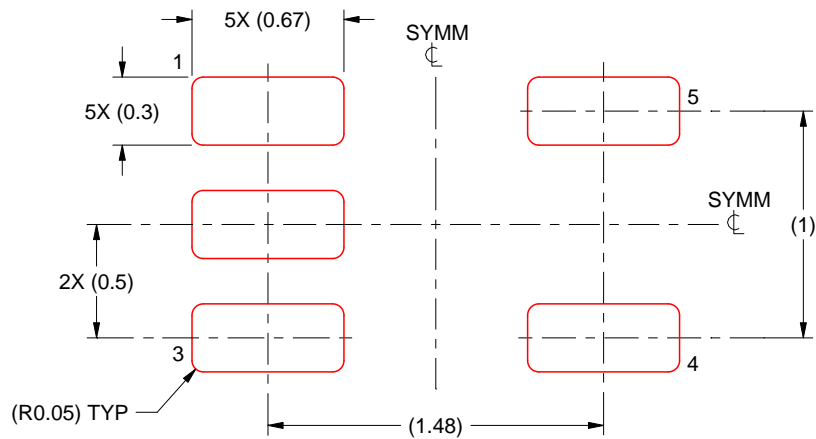
- 5. Publication IPC-7351 may have alternate designs.
- 6. Solder mask tolerances between and around signal pads can vary based on board fabrication site.

EXAMPLE STENCIL DESIGN

DRL0005A

SOT - 0.6 mm max height

PLASTIC SMALL OUTLINE



SOLDER PASTE EXAMPLE
BASED ON 0.1 mm THICK STENCIL
SCALE:30X

4220753/B 12/2020

NOTES: (continued)

7. Laser cutting apertures with trapezoidal walls and rounded corners may offer better paste release. IPC-7525 may have alternate design recommendations.
8. Board assembly site may have different recommendations for stencil design.

DCK (R-PDSO-G5)

PLASTIC SMALL-OUTLINE PACKAGE



- NOTES:
- A. All linear dimensions are in millimeters.
 - B. This drawing is subject to change without notice.
 - C. Body dimensions do not include mold flash or protrusion. Mold flash and protrusion shall not exceed 0.15 per side.
 - D. Falls within JEDEC MO-203 variation AA.

DCK (R-PDSO-G5)

PLASTIC SMALL OUTLINE



- NOTES:
- A. All linear dimensions are in millimeters.
 - B. This drawing is subject to change without notice.
 - C. Customers should place a note on the circuit board fabrication drawing not to alter the center solder mask defined pad.
 - D. Publication IPC-7351 is recommended for alternate designs.
 - E. Laser cutting apertures with trapezoidal walls and also rounding corners will offer better paste release. Customers should contact their board assembly site for stencil design recommendations. Example stencil design based on a 50% volumetric metal load solder paste. Refer to IPC-7525 for other stencil recommendations.

GENERIC PACKAGE VIEW

DRY 6

USON - 0.6 mm max height

PLASTIC SMALL OUTLINE - NO LEAD



Images above are just a representation of the package family, actual package may vary.
Refer to the product data sheet for package details.

4207181/G

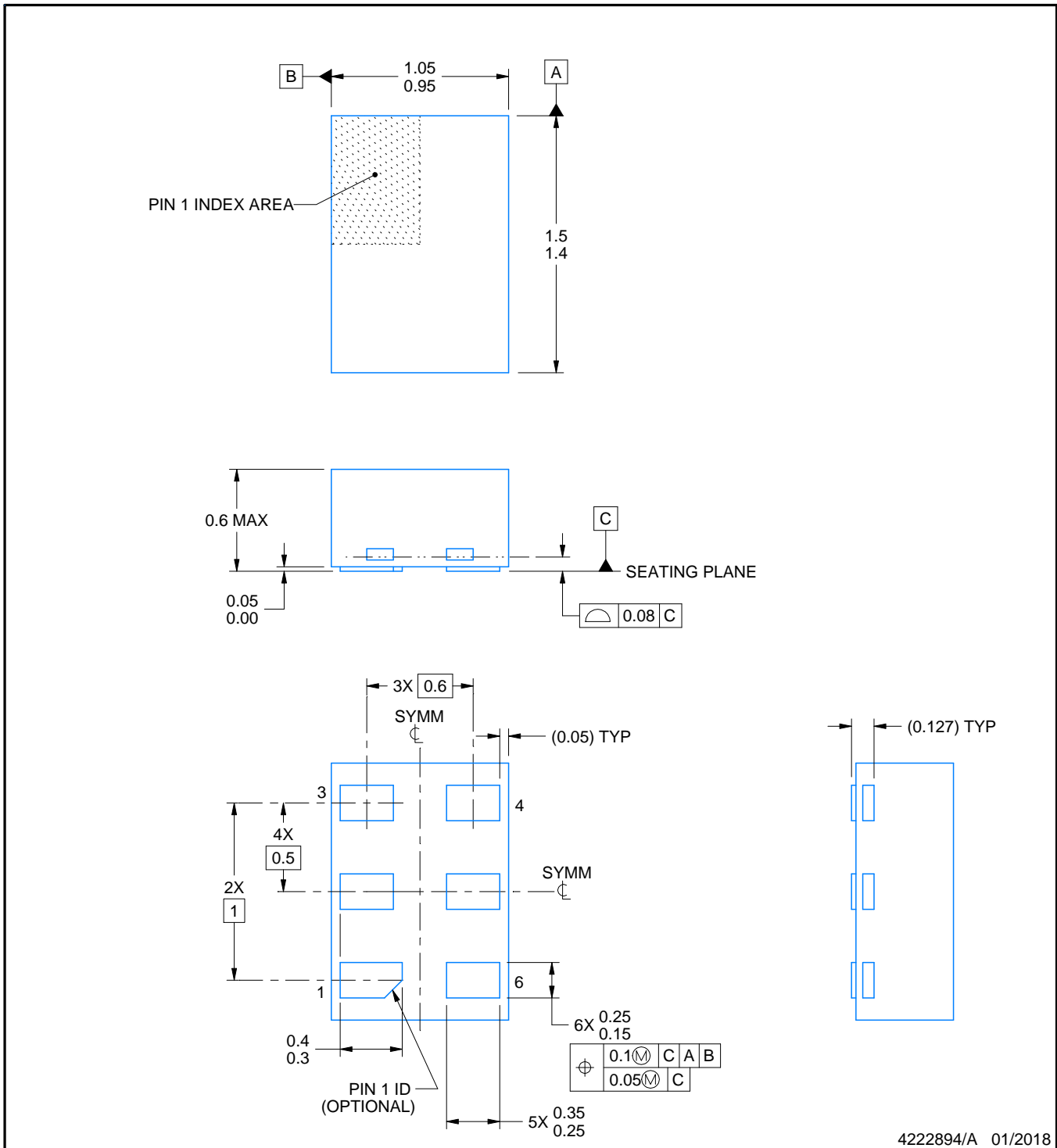
DRY0006A



PACKAGE OUTLINE

USON - 0.6 mm max height

PLASTIC SMALL OUTLINE - NO LEAD



NOTES:

1. All linear dimensions are in millimeters. Any dimensions in parenthesis are for reference only. Dimensioning and tolerancing per ASME Y14.5M.
2. This drawing is subject to change without notice.

EXAMPLE BOARD LAYOUT

DRY0006A

USON - 0.6 mm max height

PLASTIC SMALL OUTLINE - NO LEAD



LAND PATTERN EXAMPLE
1:1 RATIO WITH PKG SOLDER PADS
EXPOSED METAL SHOWN
SCALE:40X



SOLDER MASK DETAILS

4222894/A 01/2018

NOTES: (continued)

3. For more information, see QFN/SON PCB application report in literature No. SLUA271 (www.ti.com/lit/slue271).

EXAMPLE STENCIL DESIGN

DRY0006A

USON - 0.6 mm max height

PLASTIC SMALL OUTLINE - NO LEAD

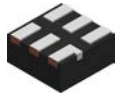


SOLDER PASTE EXAMPLE
BASED ON 0.075 - 0.1 mm THICK STENCIL
SCALE:40X

4222894/A 01/2018

NOTES: (continued)

4. Laser cutting apertures with trapezoidal walls and rounded corners may offer better paste release. IPC-7525 may have alternate design recommendations.



DSF0006A

PACKAGE OUTLINE

X2SON - 0.4 mm max height

PLASTIC SMALL OUTLINE - NO LEAD



NOTES:

1. All linear dimensions are in millimeters. Any dimensions in parenthesis are for reference only. Dimensioning and tolerancing per ASME Y14.5M.
2. This drawing is subject to change without notice.
3. Reference JEDEC registration MO-287, variation X2AAF.

EXAMPLE BOARD LAYOUT

DSF0006A

X2SON - 0.4 mm max height

PLASTIC SMALL OUTLINE - NO LEAD



LAND PATTERN EXAMPLE
EXPOSED METAL SHOWN
SCALE:40X



SOLDER MASK DETAILS

4220597/B 06/2022

NOTES: (continued)

4. For more information, see Texas Instruments literature number SLUA271 (www.ti.com/lit/slua271).

EXAMPLE STENCIL DESIGN

DSF0006A

X2SON - 0.4 mm max height

PLASTIC SMALL OUTLINE - NO LEAD



SOLDER PASTE EXAMPLE
BASED ON 0.09 mm THICK STENCIL

PRINTED SOLDER COVERAGE BY AREA UNDER PACKAGE
SCALE:40X

4220597/B 06/2022

4. Laser cutting apertures with trapezoidal walls and rounded corners may offer better paste release. IPC-7525 may have alternate design recommendations.

IMPORTANT NOTICE AND DISCLAIMER

TI PROVIDES TECHNICAL AND RELIABILITY DATA (INCLUDING DATA SHEETS), DESIGN RESOURCES (INCLUDING REFERENCE DESIGNS), APPLICATION OR OTHER DESIGN ADVICE, WEB TOOLS, SAFETY INFORMATION, AND OTHER RESOURCES "AS IS" AND WITH ALL FAULTS, AND DISCLAIMS ALL WARRANTIES, EXPRESS AND IMPLIED, INCLUDING WITHOUT LIMITATION ANY IMPLIED WARRANTIES OF MERCHANTABILITY, FITNESS FOR A PARTICULAR PURPOSE OR NON-INFRINGEMENT OF THIRD PARTY INTELLECTUAL PROPERTY RIGHTS.

These resources are intended for skilled developers designing with TI products. You are solely responsible for (1) selecting the appropriate TI products for your application, (2) designing, validating and testing your application, and (3) ensuring your application meets applicable standards, and any other safety, security, regulatory or other requirements.

These resources are subject to change without notice. TI grants you permission to use these resources only for development of an application that uses the TI products described in the resource. Other reproduction and display of these resources is prohibited. No license is granted to any other TI intellectual property right or to any third party intellectual property right. TI disclaims responsibility for, and you will fully indemnify TI and its representatives against, any claims, damages, costs, losses, and liabilities arising out of your use of these resources.

TI's products are provided subject to [TI's Terms of Sale](#) or other applicable terms available either on ti.com or provided in conjunction with such TI products. TI's provision of these resources does not expand or otherwise alter TI's applicable warranties or warranty disclaimers for TI products.

TI objects to and rejects any additional or different terms you may have proposed.

Mailing Address: Texas Instruments, Post Office Box 655303, Dallas, Texas 75265
Copyright © 2022, Texas Instruments Incorporated