

TAS2555 End-System Integration Guide

ABSTRACT

This document describes how to integrate the TAS2555 device into an end system.

Contents

1	End-System Integration	2
2	Workflow	2
3	Dump Binary File	3
4	Device Driver Integration	6
5	Tuning and Debugging in System	9

List of Figures

1	System Integration Page.....	2
2	End-System Integration Workflow	2
3	Dumping Binary File – Configuration Selection.....	3
4	Dumping Binary File – Snapshot Selection	3
5	Dumping Binary File – Take a New Snapshot	4
6	Dumping Binary File – Choose Target Device.....	4
7	Dumping Binary File – Enter DDC Name.....	4
8	Factory Test and Calibration	4
9	Summary Page.....	5
10	Dumped Files	6
11	Tuning and Debugging in System	9
12	DDC Selection for Tuning on End System (1 of 2)	10
13	DDC Selection for Tuning on End System (2 of 2)	10

List of Tables

Trademarks

Android is a trademark of Google, Inc.
 All other trademarks are the property of their respective owners.

1 End-System Integration

The System Integration feature is used to dump the binary and coefficients required to program TAS2555 device based on the Tuning Snapshots created in Audio Processing. This feature can also be used to debug/tune audio on Android™ phone.

Figure 1 shows the System Integration page of the TAS2555 application.

NOTE: The PPC3 screenshots and the information provided in this document are based on the PPC3 version 3.1.12.

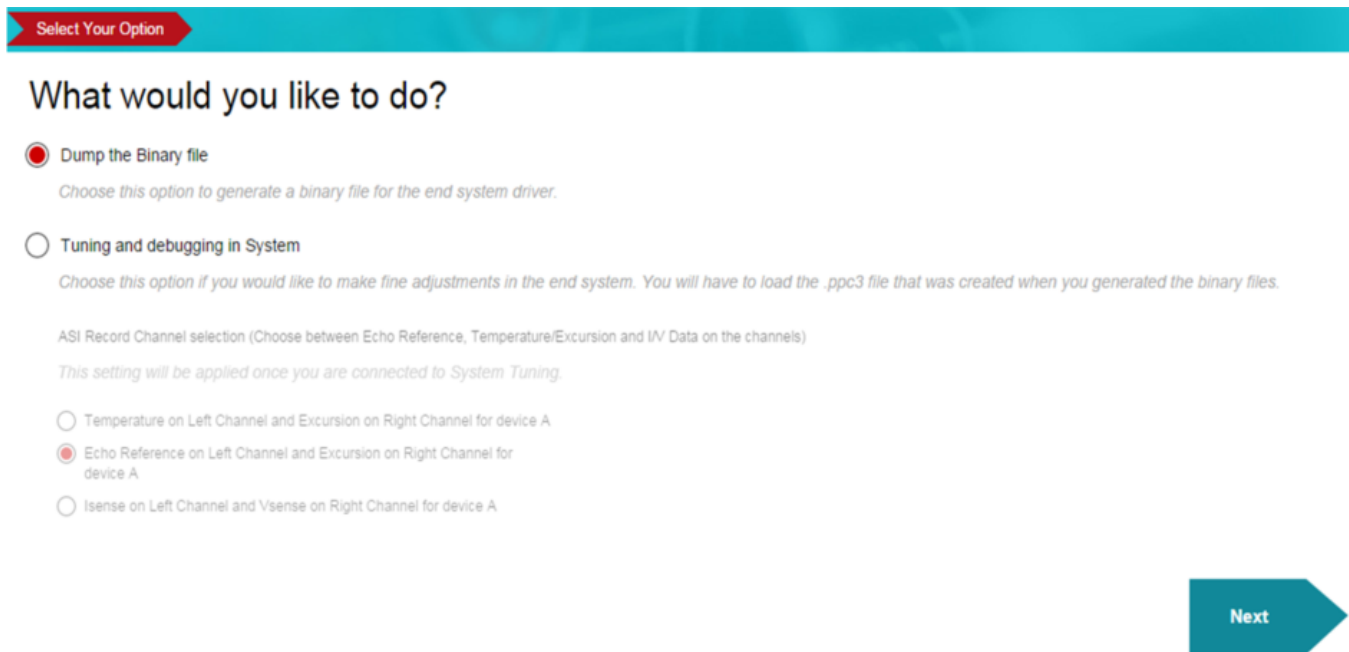
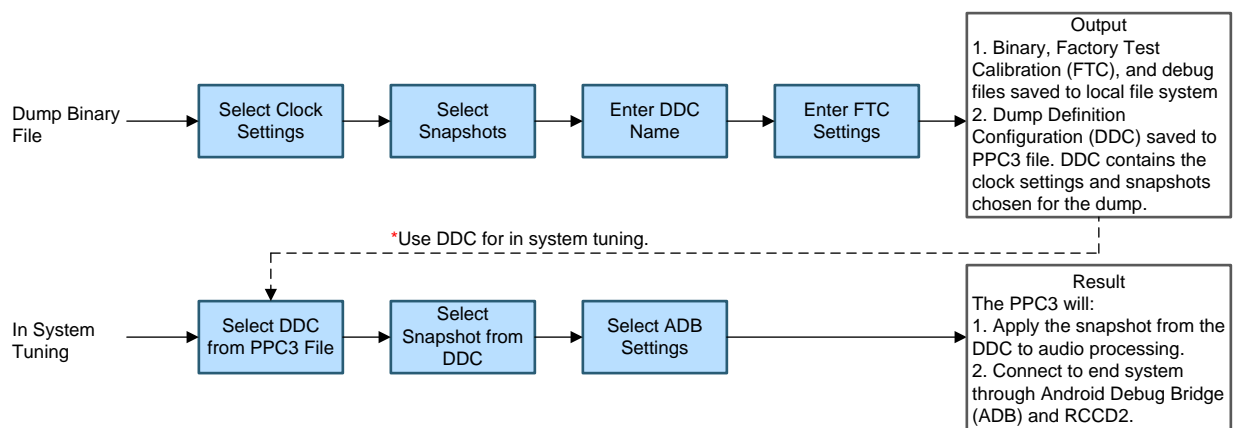

Figure 1. System Integration Page

2 Workflow

Figure 2 shows the workflow in the end-system integration.



*Choosing the correct DDC and snapshot for in system tuning ensures that PPC3 is in the same state as the end system before connecting through ADB and RCCD2.

Figure 2. End-System Integration Workflow

3 Dump Binary File

This section details the dump binary file wizard, the files that will be dumped, and how to use them.

3.1 Dump Binary Wizard

Follow these steps to dump the binary file:

1. Click 'Dump the binary file' option and click 'Next'. Configuration Selection page will appear as shown in Figure 3. In this page the user can choose the Sampling Frequency and Clocks that are available in the End System.

Application	Sampling Frequency	Clock Source	Clock Frequency	Base	
Tuning Mode	48 KHz	BCLK	1.536 MHz	<input checked="" type="radio"/>	
Tuning Mode	16 KHz	MCLK	12.288 MHz	<input type="radio"/>	

Figure 3. Dumping Binary File – Configuration Selection

2. Set the desired configuration values and click Next. The Snapshot Selection wizard appears (see Figure 4).

Snapshot Selection

Choose the snapshot with which the binary file should be created.

Application: Tuning Mode

48 KHz (Base Sampling Frequency)

1 a

16 KHz

1 a

We will be creating a configuration settings (Dump Definition Configuration - DDC) and saving it along with .ppc3 file to enable you to tune in device later. Choose an appropriate name for the DCC settings for which binary files are generated.

Test

Choose path to save generated binary files

dump

Prev Next

Figure 4. Dumping Binary File – Snapshot Selection

3. Choose an existing snapshot from the options available (if any) or take a new snapshot by clicking the Take Snapshot button (shown in Figure 5).

Choose the snapshot with which the binary file should be created.

Application: Tuning Mode

No snapshots available for selection

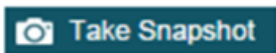

Figure 5. Dumping Binary File – Take a New Snapshot

4. Choose the Base snapshot that becomes the first Tuning Configuration in the End System. This configuration can be set as the boot configuration in the end system.



Figure 6. Dumping Binary File – Choose Target Device

5. Enter the DDC name and path once a snapshot is chosen, then click Next (see Figure 7).

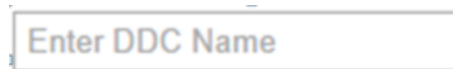

Figure 7. Dumping Binary File – Enter DDC Name

The data captured in the Factory Test and Calibration page generate a <DDC Name>.ftcfg file at the end of the wizard. A device driver on the end system uses the .ftcfg file to run the factory calibration.

Select Your Option
Dump Binary File

Factory Test and Calibration

Characterization Parameters

Re	: 6.7 Ohm	CMWF	: 891 Hz	BI	: 0.814 Tm	Mms	: 0.0667 g
Rtv	: 63.4 KW	Rtm	: 566.7 KW	Rtva	: 136 KW	System Gain(DAC+Ampl)	: 9.35 Volt/F.S
Device Non-linearity	: 1.5 %	Thermal Limit	: 80 Δ°C	PIG	: 1 (dB)	Temperature Coefficient	: 0.0033 K-1
Sampling Frequency	: 16000 Hz						

Pass / Fail Limits

Re High	<input type="text" value="7.975"/> Ohm	Re Low	<input type="text" value="6.525"/> Ohm	F0 High	<input type="text" value="924"/> Hz	F0 Low	<input type="text" value="616"/> Hz
Q High	<input type="text" value="1.704"/>	Q Low	<input type="text" value="1.136"/>	Temperature High	<input type="text" value="40"/> Δ°C	Temperature Low	<input type="text" value="0"/> Δ°C

Speaker Manufacturer Data

Maximum Temperature	<input type="text" value="100"/> °C	Re Tolerance (+/-)	<input type="text" value="10"/> %
---------------------	-------------------------------------	--------------------	-----------------------------------

Prev

Dump

Figure 8. Factory Test and Calibration

Figure 9 shows the result of binary file and associated file generation.

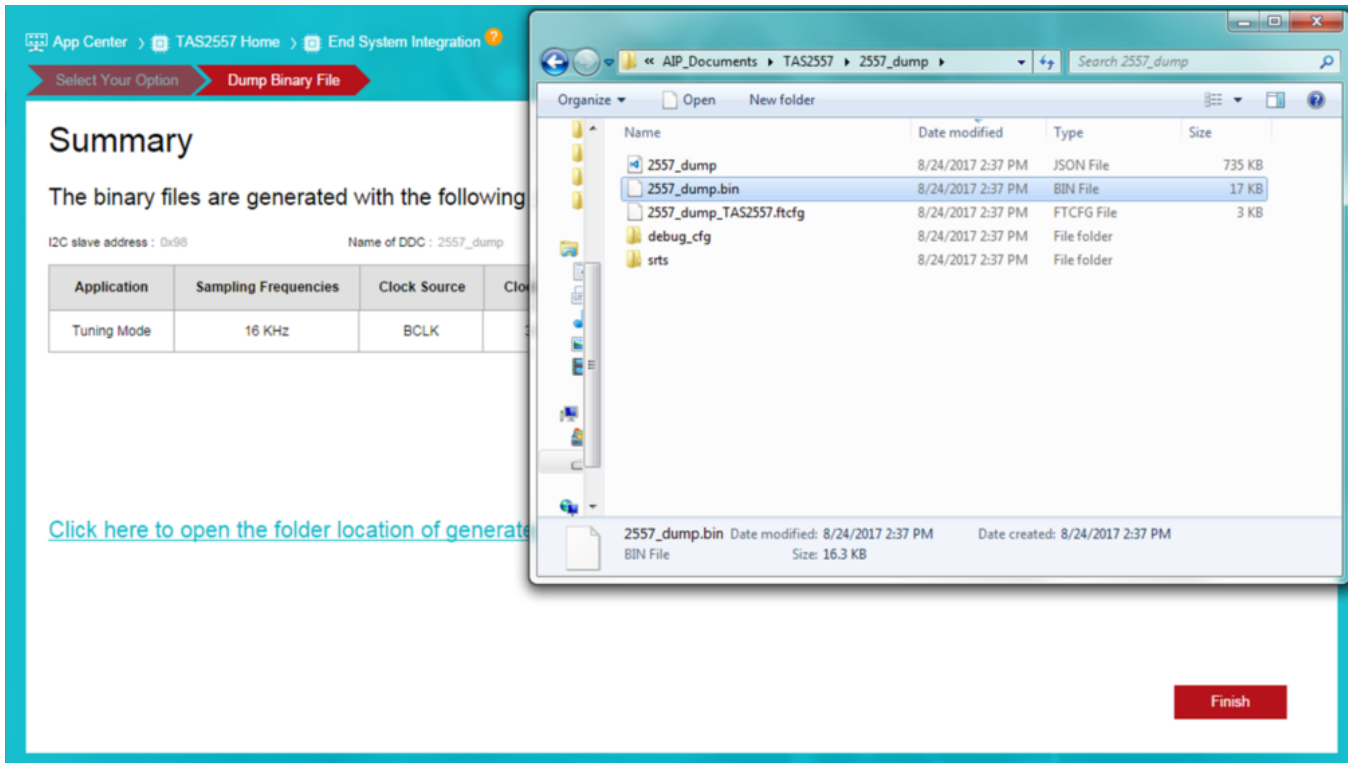

Figure 9. Summary Page

3.2 Overview of Files Dumped by PPC3

Figure 10 shows the dumped files.

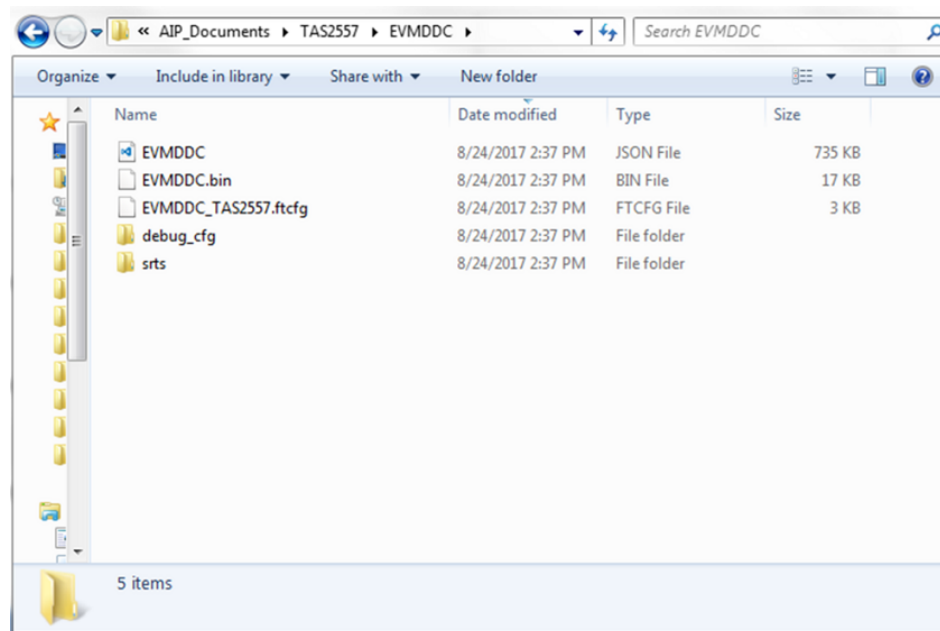

Figure 10. Dumped Files

3.2.1 Description of Files Dumped

3.2.1.1 EVMDDC.bin

The EVMDDC.bin file is recommended to use in platforms with file systems. The file contains all of the information required to program the TAS2555 except power and mute sequences. All Android devices with the TAS2555 use this file format.

3.2.1.2 EVMDDC.ftcfg

Device driver uses this file to get the characterization data of the speaker to run the factory line calibration process on the end system.

3.2.1.3 Debug Files

The following debug files are dumped in addition to the EVMDDC.ftcfg and EVMDDC.bin files: EVMDDC.json, debug_cfg, debug.cfg, and more.

4 Device Driver Integration

This section describes the sequence of programming by the device driver in the end system. The sequence of programming depends on the state in which the end system is currently in. This section lists the sequence of programming for each such state.

Example device driver code is available with TI. Users can use the example driver to port to their platform.

4.1 Case One

Programming the TAS2555 for the first time:

Use case: device initialization during system boot up.

Assume that users are programming configuration 0.

Steps to playback:

1. Hardware reset.
2. Software reset.
3. Download the program that accommodates configuration 0.
EVMDDC_program_0_Tuning Mode.cfg
4. Download the PLL that accommodates configuration 0.
EVMDDC_pll_0_TuningMode_48KHz.cfg
5. Download the predata that accommodates configuration 0.
EVMDDC_configuration_0_TuningMode_48KHz_DEV_A_PRE.cfg
6. Feed the PLL clock. Audio stream may start any time after this step.
7. Power on the TAS2555.
8. Download the post power power up block that accommodates configuration 0.
Configuration 0 does not have a post power up block.
9. Unmute the TAS2555 device.

Steps to sleep:

1. Mute and shutdown the TAS2555 device.

4.2 Case Two

TAS2555 has been programmed and there is no need to change the configuration.

Use case: device power up to play music.

Steps to playback:

1. Feed the PLL clock. Audio stream may start any time after the PLL clock is available.
2. Power on the TAS2555 device.
3. Download the post power up block if present (this should accommodate to the current configuration).
4. Unmute the TAS2555 device.

Steps to sleep:

1. Mute and shut down the TAS2555 device.

4.3 Case Three

Need to change to a new configuration with the same program and same PLL.

Assume users are going to program configuration 1.

Steps to playback:

NOTE: If the music is playing and the TAS2555 device is running, go to step 4.

1. Feed the PLL clock.
2. Power on the TAS2555 device.
3. Download the post power up block that accommodates configuration 1.
Configuration 1 does not have a post power up block.
4. Download coefficient that accommodates configuration 1.
EVMDDC_configuration_1_TuningMode_48KHz_DEV_A_COEFF.cfg

Steps to sleep:

1. Mute and shutdown the TAS2555 device.

4.4 Case Four

Need to change to a new configuration with the same program and different PLL.

Assume users are going to program configuration 2.

If the music is playing and the TAS2555 device is running, mute the shut down the TAS255 device.

1. Download a new PLL that accommodates configuration 2.
EVMDDC_pll_1_TuningMode_44.1KHz.cfg
2. Download new configuration predata that accommodates configuration 2.
EVMDDC_configuration_2_TuningMode_44.1KHz_DEV_A_PRE.cfg
3. Feed the PLL clock.
4. Power on the TAS2555 device.
5. Download the post power up block that accommodates configuration 2.
Configuration 2 does not have a post power up block.
6. Download the coefficient that accommodates configuration 2.
EVMDDC_configuration_2_TuningMode_44.1KHz_DEV_A_COEFF.cfg

Steps to sleep:

1. Mute and shutdown the TAS2555 device.

4.5 Case Five

Need to change to a new configuration with a different program.

For example, switching to ROM mode1.

Assume users are going to program configuration 3.

Steps to playback:

If music is playing and the TAS2555 device is running, mute and shut down the TAS2555 device.

1. Hardware reset.
2. Software reset.
3. Download the program that accommodates configuration 3.
EVMDDC_program_1_ROM1Mode.cfg
4. Download the PLL that accommodates configuration 3.
EVMDDC_pll_2_ROM1Mode_48KHz.cfg
5. Download the configuration predata that accommodates configuration 3.
EVMDDC_configuration_3_ROM!Mode_48KHz_DEV_A_PRE.cfg
6. Feed the PLL clock. Audio stream may start any time after this step.
7. Power on the TAS2555 device.
8. Download the post power up block that accommodates configuration 3.
EVMDDC_configuration_3_ROMMode1_48KHz_POST_POWER_UP.cfg
9. Unmute the TAS2555 device.

Steps to sleep:

1. Mute and shutdown the TAS2555 device.

4.6 Power Management Scripts

See [tas2555-android-driver](#).

4.7 Power On Sequence

p_tas2555_startup_data

4.8 Unmute Sequence

p_tas2555_unmute_data

4.9 Mute and Shutdown Sequence

p_tas2555_shutdown_data

4.10 EVMDDC.bin Parser

See [tas2555-android-driver](#).

fw_parse()

5 Tuning and Debugging in System

With the In System Tuning feature available in PPC3, the user can connect the end system to the PPC3 through an Android Debug Bridge (ADB). Once connected, the user can start tuning audio directly on the end system.

5.1 Download Tuning Data to End System

Use the PPC3 file that contains the Dump Definition Configuration (DDC) used for generating the binary file in [Section 3.1](#). Select Tuning and debugging in System and select the required snapshot in the DDC to tune on the end system. See [Figure 11](#) and [Figure 12](#).

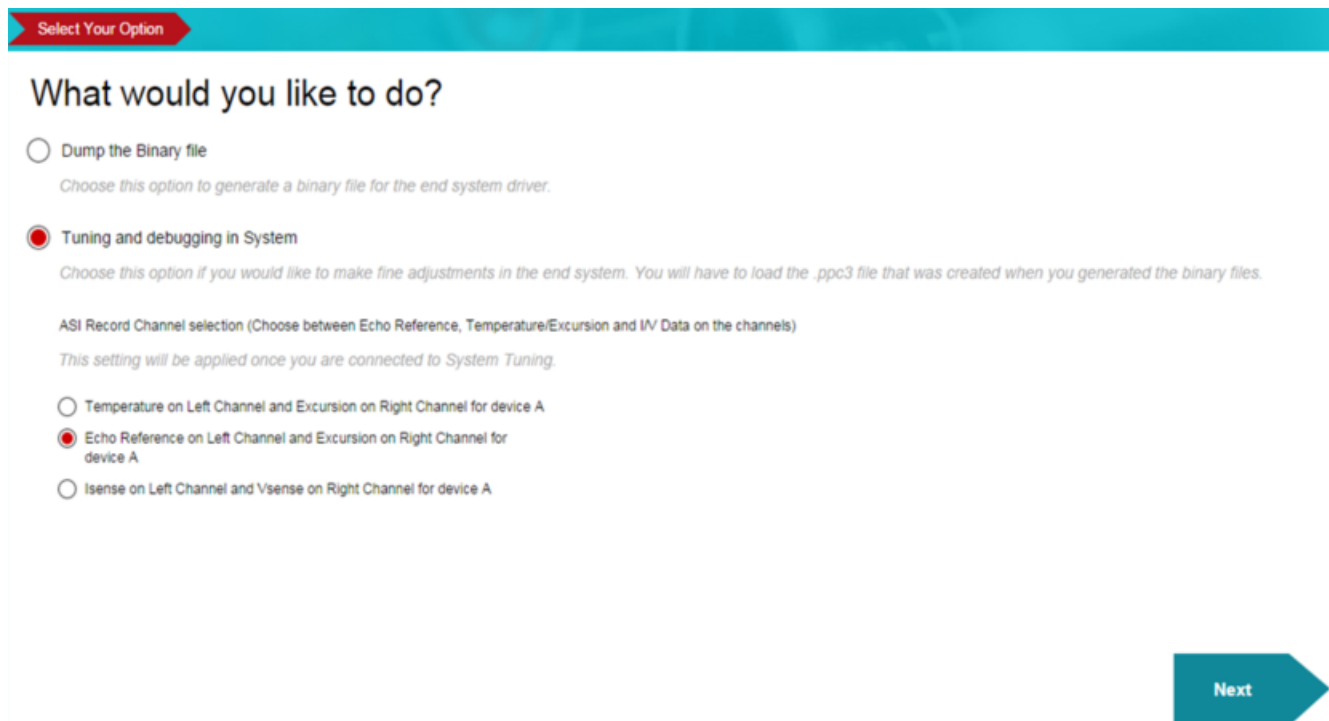

The screenshot shows a dialog box titled "Select Your Option" with a teal header. The main question is "What would you like to do?". There are two radio button options:

- Dump the Binary file
Choose this option to generate a binary file for the end system driver.
- Tuning and debugging in System
Choose this option if you would like to make fine adjustments in the end system. You will have to load the .ppc3 file that was created when you generated the binary files.

Below these options is a section for "ASI Record Channel selection (Choose between Echo Reference, Temperature/Excursion and IV Data on the channels)". A note states: "This setting will be applied once you are connected to System Tuning." There are three radio button options:

- Temperature on Left Channel and Excursion on Right Channel for device A
- Echo Reference on Left Channel and Excursion on Right Channel for device A
- Isense on Left Channel and Vsense on Right Channel for device A

A teal arrow button labeled "Next" is located at the bottom right of the dialog box.

Figure 11. Tuning and Debugging in System

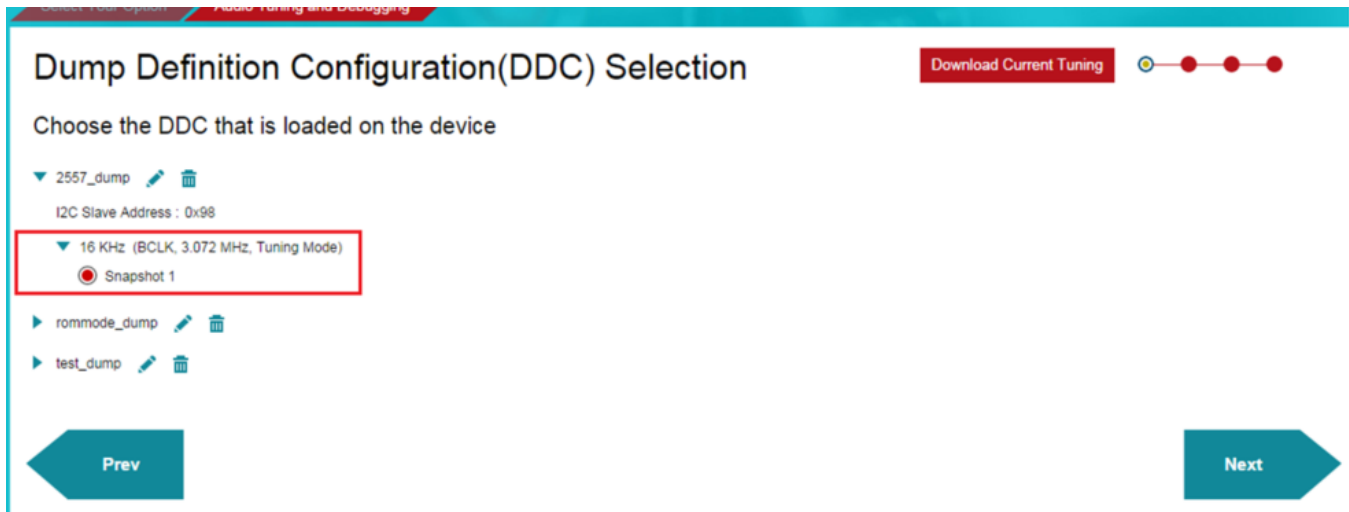

Figure 12. DDC Selection for Tuning on End System (1 of 2)

Alternatively, users can download the current GUI settings to the end system instead of the DDC by clicking on the Download Current Tuning (see Figure 13).

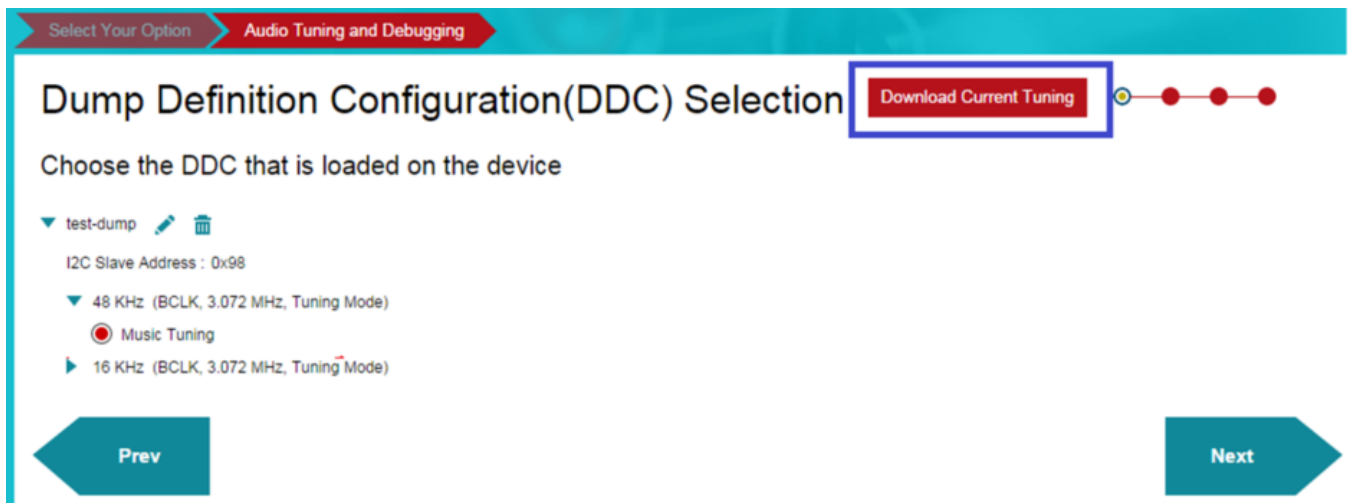

Figure 13. DDC Selection for Tuning on End System (2 of 2)

After selecting one of the options in Figure 13, users can click the Tuning and Audio Processing to tune the end system.

Revision History

NOTE: Page numbers for previous revisions may differ from page numbers in the current version.

Date	Version	Description
September 2017	*	Initial release

IMPORTANT NOTICE FOR TI DESIGN INFORMATION AND RESOURCES

Texas Instruments Incorporated ("TI") technical, application or other design advice, services or information, including, but not limited to, reference designs and materials relating to evaluation modules, (collectively, "TI Resources") are intended to assist designers who are developing applications that incorporate TI products; by downloading, accessing or using any particular TI Resource in any way, you (individually or, if you are acting on behalf of a company, your company) agree to use it solely for this purpose and subject to the terms of this Notice.

TI's provision of TI Resources does not expand or otherwise alter TI's applicable published warranties or warranty disclaimers for TI products, and no additional obligations or liabilities arise from TI providing such TI Resources. TI reserves the right to make corrections, enhancements, improvements and other changes to its TI Resources.

You understand and agree that you remain responsible for using your independent analysis, evaluation and judgment in designing your applications and that you have full and exclusive responsibility to assure the safety of your applications and compliance of your applications (and of all TI products used in or for your applications) with all applicable regulations, laws and other applicable requirements. You represent that, with respect to your applications, you have all the necessary expertise to create and implement safeguards that (1) anticipate dangerous consequences of failures, (2) monitor failures and their consequences, and (3) lessen the likelihood of failures that might cause harm and take appropriate actions. You agree that prior to using or distributing any applications that include TI products, you will thoroughly test such applications and the functionality of such TI products as used in such applications. TI has not conducted any testing other than that specifically described in the published documentation for a particular TI Resource.

You are authorized to use, copy and modify any individual TI Resource only in connection with the development of applications that include the TI product(s) identified in such TI Resource. NO OTHER LICENSE, EXPRESS OR IMPLIED, BY ESTOPPEL OR OTHERWISE TO ANY OTHER TI INTELLECTUAL PROPERTY RIGHT, AND NO LICENSE TO ANY TECHNOLOGY OR INTELLECTUAL PROPERTY RIGHT OF TI OR ANY THIRD PARTY IS GRANTED HEREIN, including but not limited to any patent right, copyright, mask work right, or other intellectual property right relating to any combination, machine, or process in which TI products or services are used. Information regarding or referencing third-party products or services does not constitute a license to use such products or services, or a warranty or endorsement thereof. Use of TI Resources may require a license from a third party under the patents or other intellectual property of the third party, or a license from TI under the patents or other intellectual property of TI.

TI RESOURCES ARE PROVIDED "AS IS" AND WITH ALL FAULTS. TI DISCLAIMS ALL OTHER WARRANTIES OR REPRESENTATIONS, EXPRESS OR IMPLIED, REGARDING TI RESOURCES OR USE THEREOF, INCLUDING BUT NOT LIMITED TO ACCURACY OR COMPLETENESS, TITLE, ANY EPIDEMIC FAILURE WARRANTY AND ANY IMPLIED WARRANTIES OF MERCHANTABILITY, FITNESS FOR A PARTICULAR PURPOSE, AND NON-INFRINGEMENT OF ANY THIRD PARTY INTELLECTUAL PROPERTY RIGHTS.

TI SHALL NOT BE LIABLE FOR AND SHALL NOT DEFEND OR INDEMNIFY YOU AGAINST ANY CLAIM, INCLUDING BUT NOT LIMITED TO ANY INFRINGEMENT CLAIM THAT RELATES TO OR IS BASED ON ANY COMBINATION OF PRODUCTS EVEN IF DESCRIBED IN TI RESOURCES OR OTHERWISE. IN NO EVENT SHALL TI BE LIABLE FOR ANY ACTUAL, DIRECT, SPECIAL, COLLATERAL, INDIRECT, PUNITIVE, INCIDENTAL, CONSEQUENTIAL OR EXEMPLARY DAMAGES IN CONNECTION WITH OR ARISING OUT OF TI RESOURCES OR USE THEREOF, AND REGARDLESS OF WHETHER TI HAS BEEN ADVISED OF THE POSSIBILITY OF SUCH DAMAGES.

You agree to fully indemnify TI and its representatives against any damages, costs, losses, and/or liabilities arising out of your non-compliance with the terms and provisions of this Notice.

This Notice applies to TI Resources. Additional terms apply to the use and purchase of certain types of materials, TI products and services. These include; without limitation, TI's standard terms for semiconductor products (<http://www.ti.com/sc/docs/stdterms.htm>), [evaluation modules](#), and [samples](http://www.ti.com/sc/docs/sampterm.htm) (<http://www.ti.com/sc/docs/sampterm.htm>).

Mailing Address: Texas Instruments, Post Office Box 655303, Dallas, Texas 75265
Copyright © 2017, Texas Instruments Incorporated