

Smart Amp Quick Start Guide

ABSTRACT

This document provides a guide on the steps required to go from speaker selection to production with Texas Instruments' IV Sense or Smart Amp products.

Contents

1	Introduction	2
2	Device Overview	2
3	Speaker Parameters	2
4	Speaker Characterization	3
5	Characterization Results	16
6	Speaker Tuning	17
7	Schematic Review	18
8	Layout Review	20
9	Factory Test and Calibration (FTC) Implementation	23
10	System Integration Guidance	28

Trademarks

Texas Instruments, TI E2E are trademarks of Texas Instruments.
All other trademarks are the property of their respective owners.

1 Introduction

IV Sense amplifiers or Smart Amps from Texas Instruments™ build upon the classic Class-D audio amplifier by adding the ability to real-time monitor the temperature and excursion of the speaker. Typical amplifiers do not have this capability and revert to attenuating the entire audio signal to ensure reliability. This attenuation results in lower sound pressure level (SPL) and overall audio quality. Smart Amp uses the real-time temperature and excursion data to update the speaker model in real-time. This is controlled by an algorithm running in the DSP inside the device. This feedback allows the device to monitor the health of the speaker and optimize the sound quality to enable great audio.

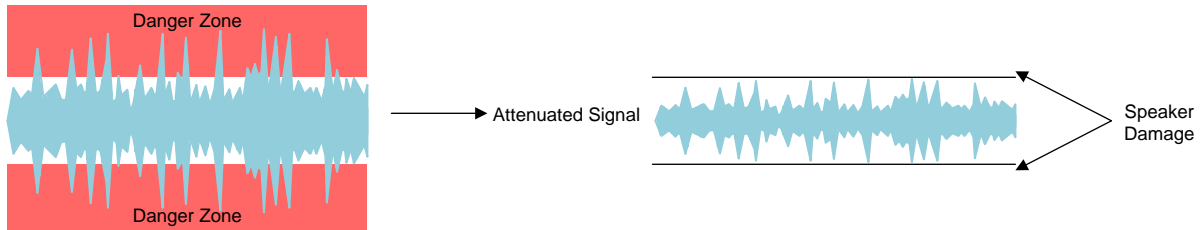

Figure 1. Standard Class-D Audio Amplifiers

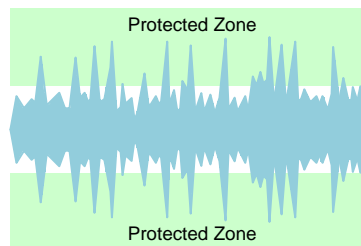

Figure 2. IV Sense Class-D Audio Amplifiers

Smart Amp system:

- System supports continuous speaker modeling
- Output power and peaks constantly optimized for maximum sound and reliability
- Preserving peaks for improved audio clarity
- Excursion headroom used for improving bass

2 Device Overview

One of the first steps in an audio design is to decide which speaker to use. There are many different parameters to look at when making this decision: output power, SPL, size, cost, and more. TI's Smart Amp products work with a wide variety of speakers on the market, and it is important to confirm the following items to ensure highest audio quality:

- Nominal speaker impedance: 4 to 32 Ω
- Resonant frequency: 200 to 1400 Hz

If the speaker follows the above guidelines, it will allow for the highest quality of TI audio at the maximum sound pressure level.

3 Speaker Parameters

It is important to know where to get the speaker parameters and to ensure their accuracy when starting an audio design. For Smart Amp devices, these parameters affect how the algorithm protects the speaker. [Table 1](#) lists where to find the most important speaker parameters. Some of the parameters can be found by using the Learning Board 2 (see [Smart Amplifier Speaker Characterization Board Evaluation Module](#)) characterization, but it is always best to request these details in a data sheet from your speaker vendor.

Table 1. Smart Amp Speaker Parameters

Key Parameters	Obtained From Speaker Vendor Data Sheet	Obtained From Learning Board Characterization
Xmax (mm)	Yes	No
Tmax (°C)	Yes	No
Temperature Coefficient (K ⁻¹)	Yes	No
Sd (cm ²)	Yes	No
Bl	Yes	No
Re (Ω)	Yes	Yes
f0 (Hz)	Yes	Yes
Tolerances of Re	Yes	No
Impedance transfer function	Yes	Yes
Excursion transfer function	Yes	Yes

4 Speaker Characterization

Advanced speaker modeling is essential to maximizing the performance of the selected speaker while still protecting it from damage. The speaker model can be obtained using the characterization process in PPC3 (access can be requested on the Smart Amp product folder on ti.com). TI's Smart Amp algorithm then uses this model to protect the speaker during operation while maintaining the loudest and highest quality audio. This section will walk through how to characterize a speaker in PPC3.

The linear parameters of the speaker can be obtained through the Characterization tab in the PPC3 software. Characterization of the speaker is done using the Learning Board 2 along with the EVM and PPC3 Software.

1. Select Characterization (shown in [Figure 3](#)) and follow the hardware setup shown in [Figure 4](#).

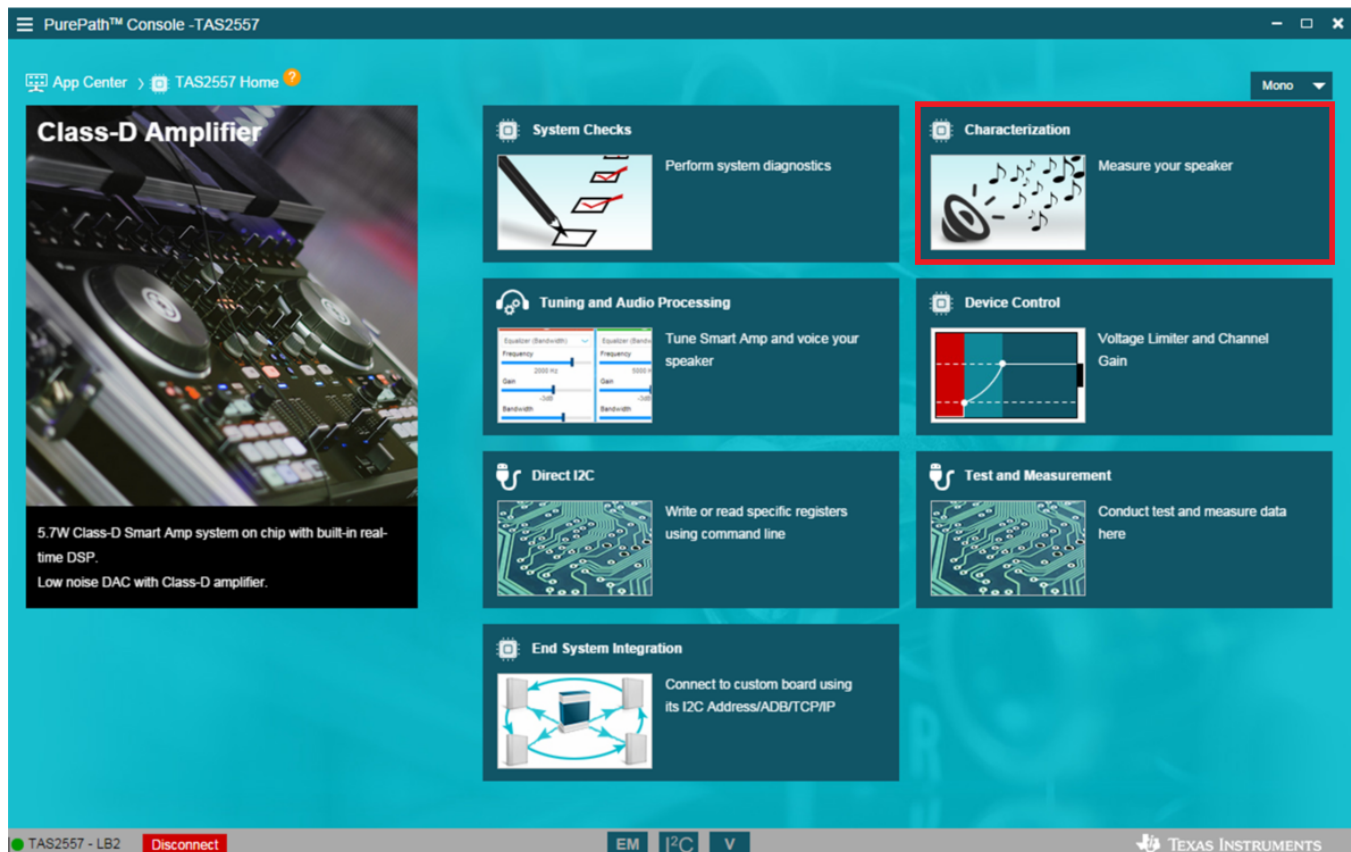

Figure 3. PPC3 Home Page

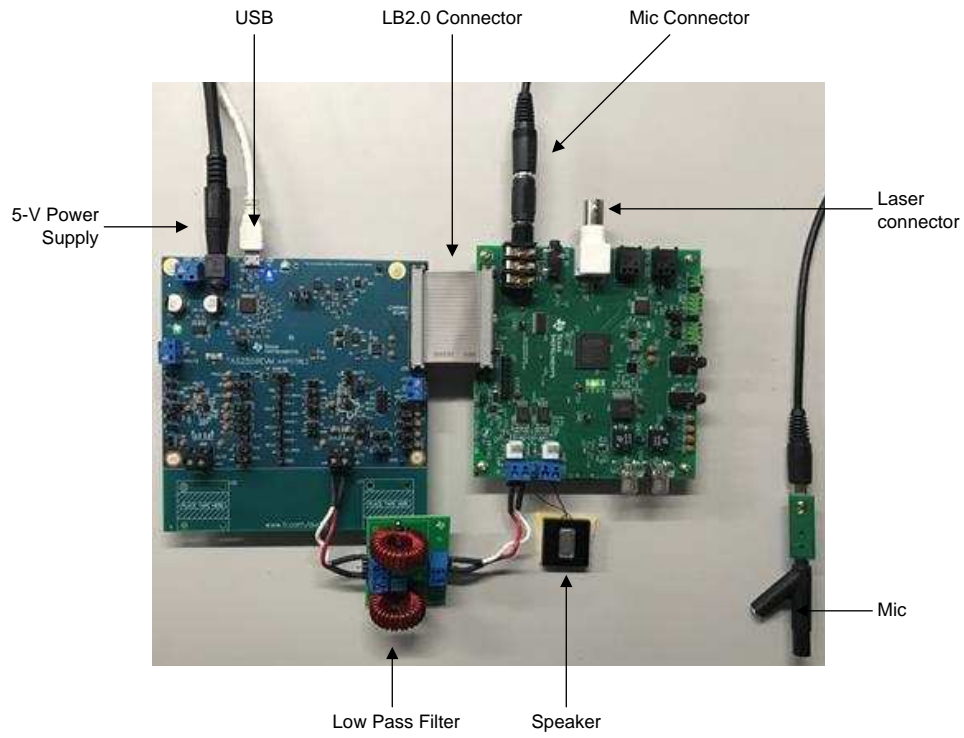

Figure 4. Hardware Setup

NOTE: Verify the direction of the low pass filter that is shown in [Figure 4](#).

- Verify jumper settings are according to the default jumper settings table found in the EVM user guide as listed in [Table 2](#).

Table 2. TAS2557 EVM Default Jumper Settings

Jumper	Setting	Description	Channel
J2	Insert	VBAT 5 V	
J3	Remove	DOUT	1
J4	Insert	DVDD 1.8 V	1
J6	Insert	AVDD 1.8 V	1
J7	Insert	IOVDD setting from J30	1
J9	Remove	SCL and SS	1
J10	Remove	SDA and MOSI	1
J11	Insert	Address Select1	1
J12	Insert	Address Select0	1
J13	Insert	SPI select	1
J14	Remove	IRQ	1
J15	Pin 1-2	SDIN = onboard	1
J16	Pin 1-2	WCLK = onboard	1
J17	Pin 1-2	BCLK = onboard	1
J18	Pin 1-2	MCLK = onboard	1
J19	Pin 1-2	SCL = onboard	1
J20	Pin 1-2	SDA = onboard	1
J22	Remove	Reset	1
J24	Insert	WP = 1, write protect EEPROM	
J25	Remove	DOUT	2
J26	Insert	P1 = 0, select USB for onboard digital audio	
J27	Insert	P0 = 0, select USB for onboard digital audio	
J30	Pin 1-2	IOVDD select = 3.3 V	2
J32	Pin 1-2	SDIN = onboard	2
J33	Pin 1-2	WCLK = onboard	2
J34	Pin 1-2	BCLK = onboard	2
J35	Pin 1-2	MCLK = onboard	2
J36	Pin 1-2	SCL = onboard	2
J37	Pin 1-2	SDA = onboard	2
J38	Insert	DVDD 1.8 V	2
J39	Insert	AVDD 1.8 V	2
J41	Insert	IOVDD setting from J30	2
J42	Remove	Reset	2
J43	Remove	SCL and SS	2
J45	Remove	SDA and MOSI	2
J46	Insert	Address Select1	2
J47	Remove	Address Select0	2
J48	Insert	SPI select	2
J49	Remove	IRQ	2
J51	Insert	ICC = 1, inter-chip communication	
J52	Insert	ICC = 1, inter-chip communication	
J53	Insert	ICC = 1, inter-chip communication	

3. Continue to the Speaker Selection tab once the hardware is set up, then select Microspeaker (Single Driver Closed Box).

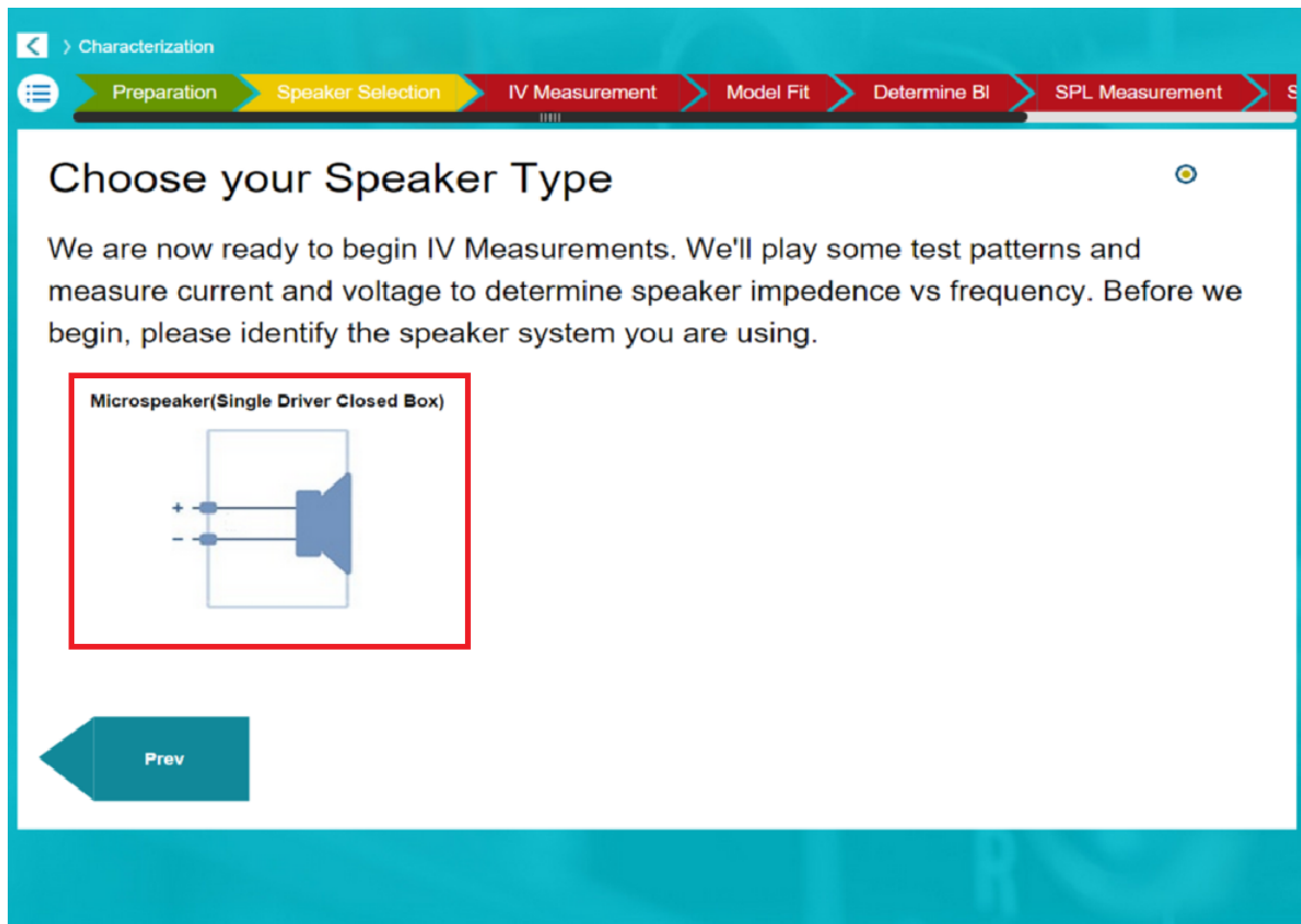

Figure 5. Speaker Selection

- Continue to the IV Measurement tab and select Start IV Measurement once the speakers are connected to the outputs of the Learning Board 2.

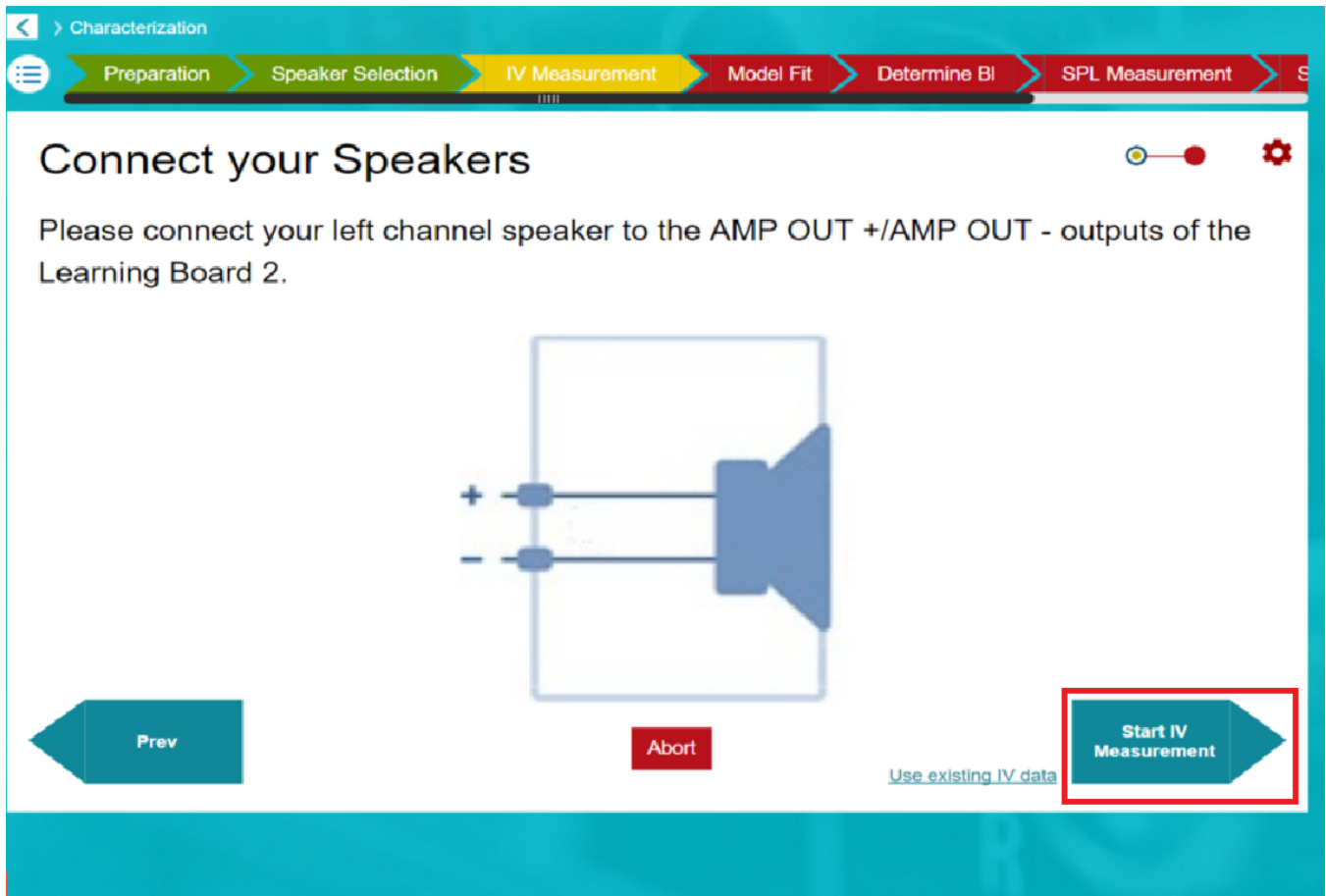

Figure 6. IV Measurement

5. Move on to the Model Fit tab and review the speaker model.

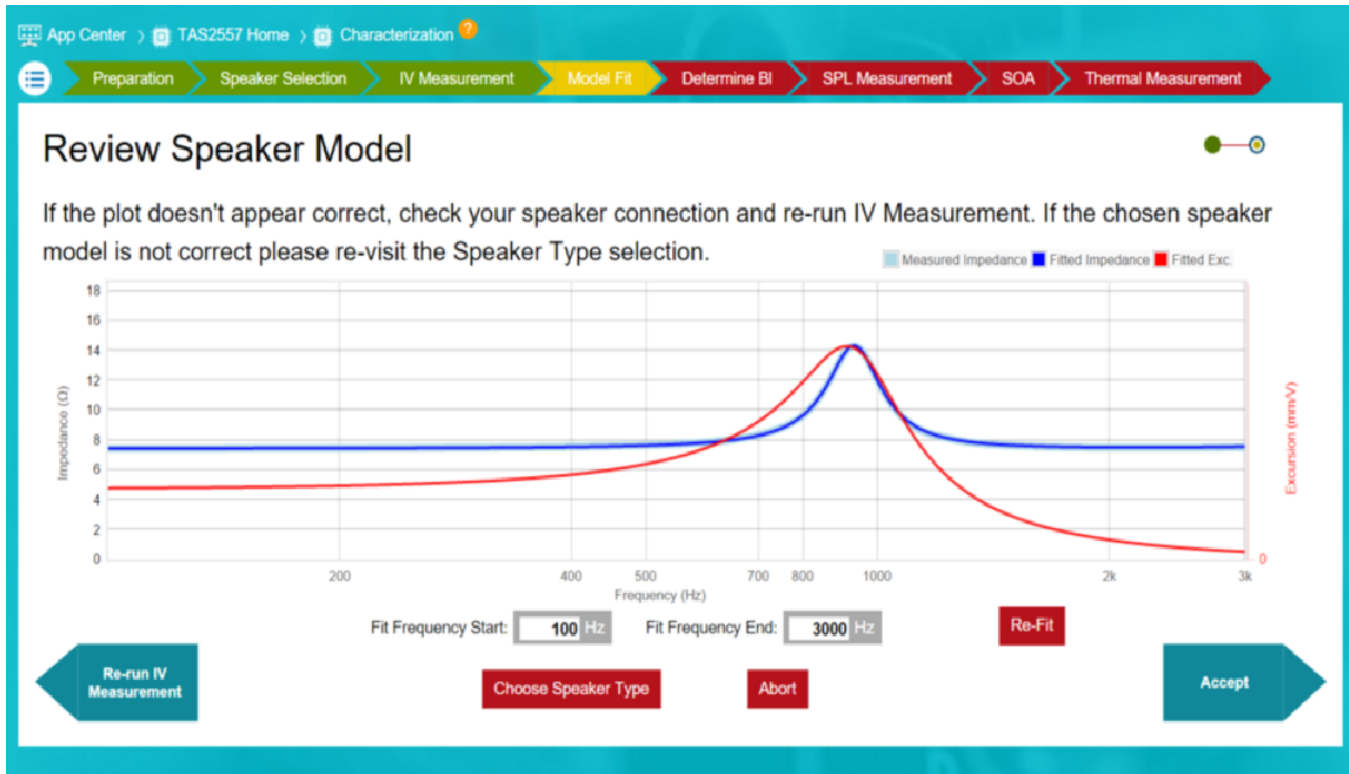

Figure 7. Model Fit

- Continue to the Determine BI step and enter either the speaker area or the diameter of the surround.

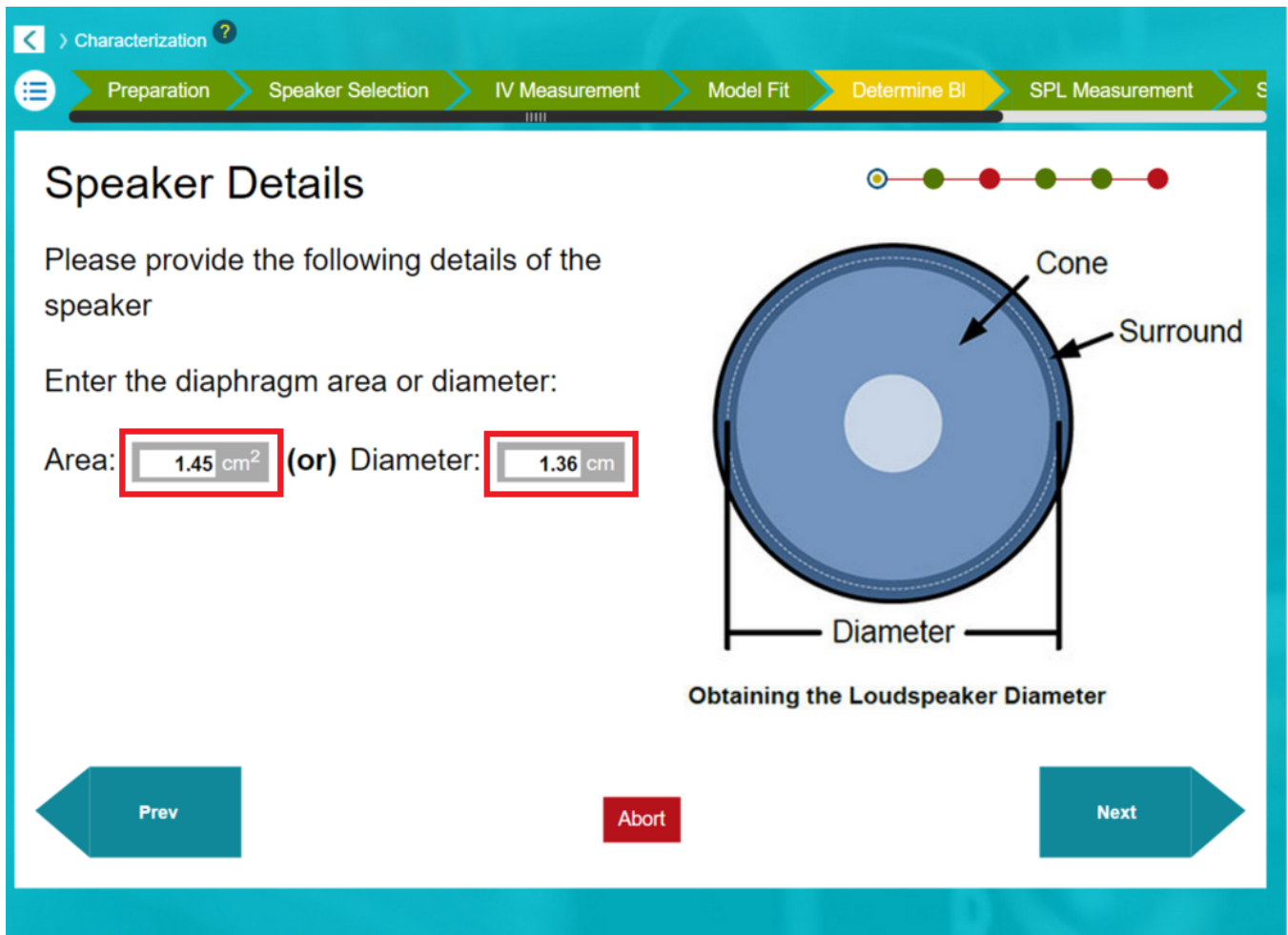

Figure 8. Determine BI

- Continue to the SPL Measurement Tab and select Check Microphone, as shown in Figure 9, to test the microphone and then begin the SPL Measurement to obtain an SPL similar to Figure 10.

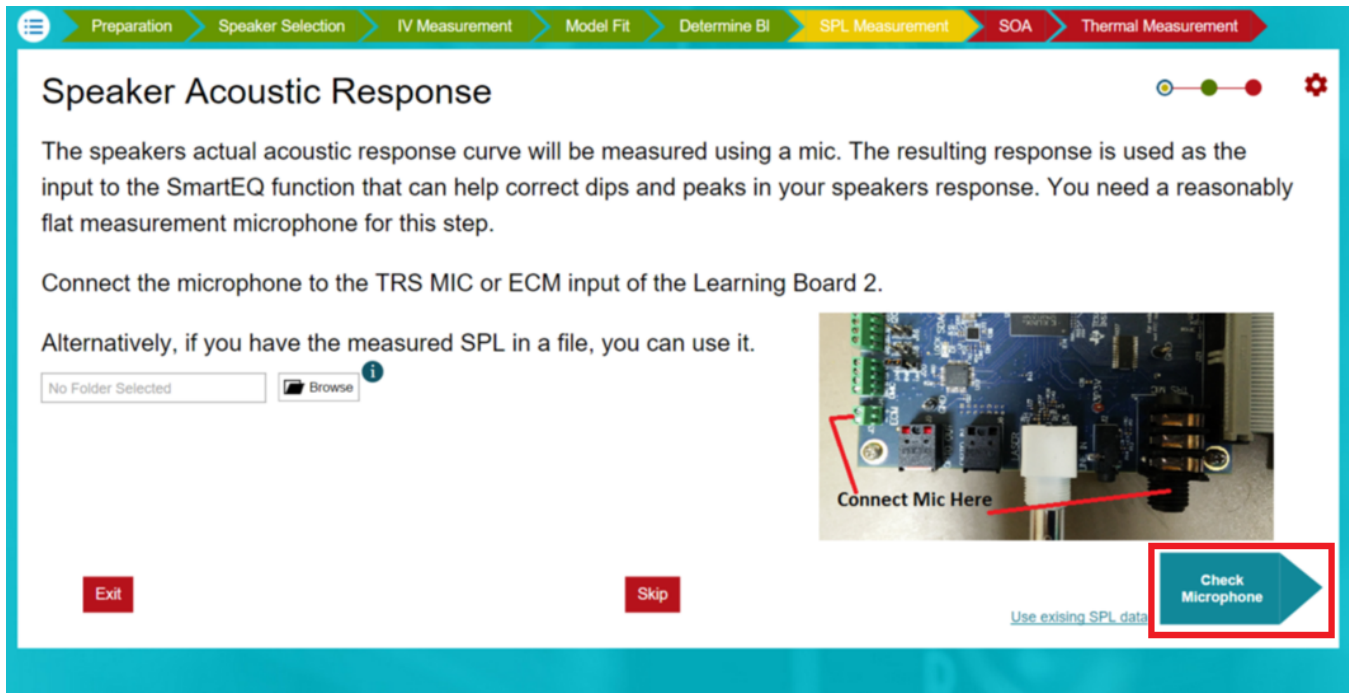

Figure 9. SPL Measurement

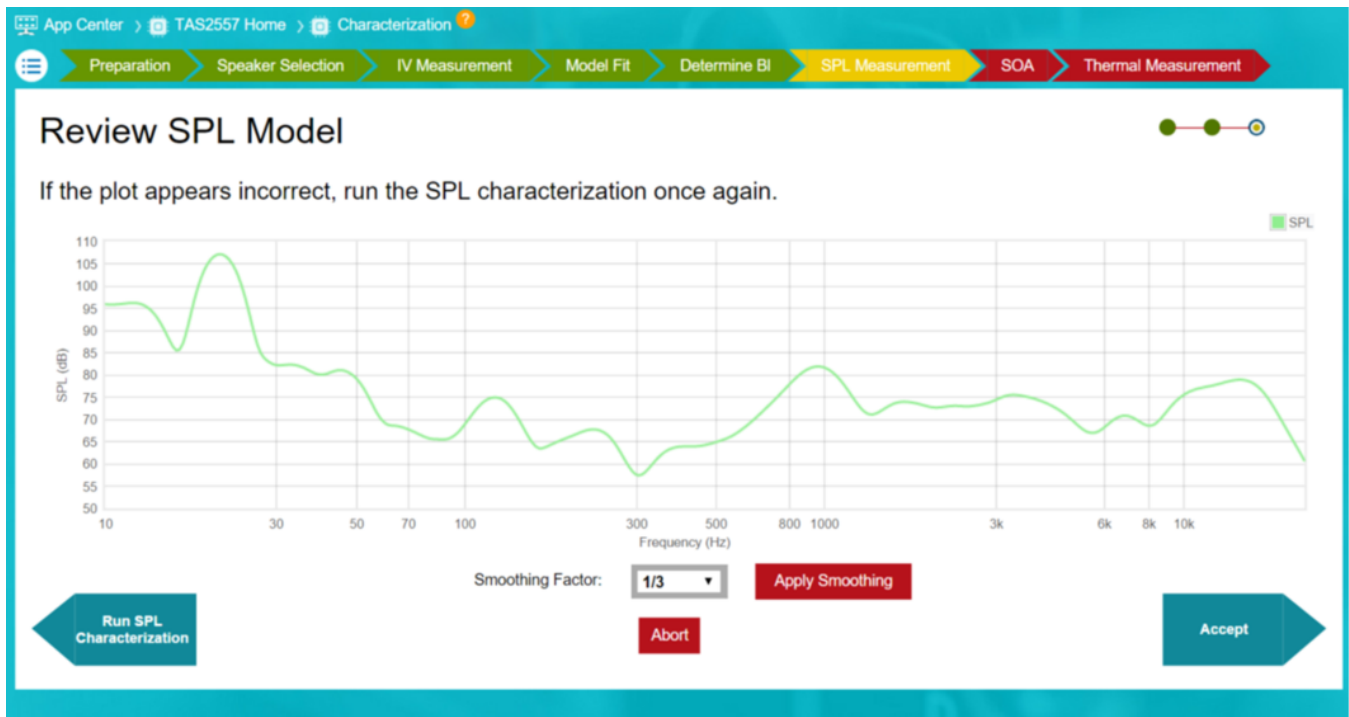

Figure 10. SPL Measurement Plot

- Continue to the Safe Operating Area step and enter the Excursion Limit (X_{MAX}) and the Thermal Limit (delta between speaker T_{MAX} and ambient temperature during the speaker characterization process).

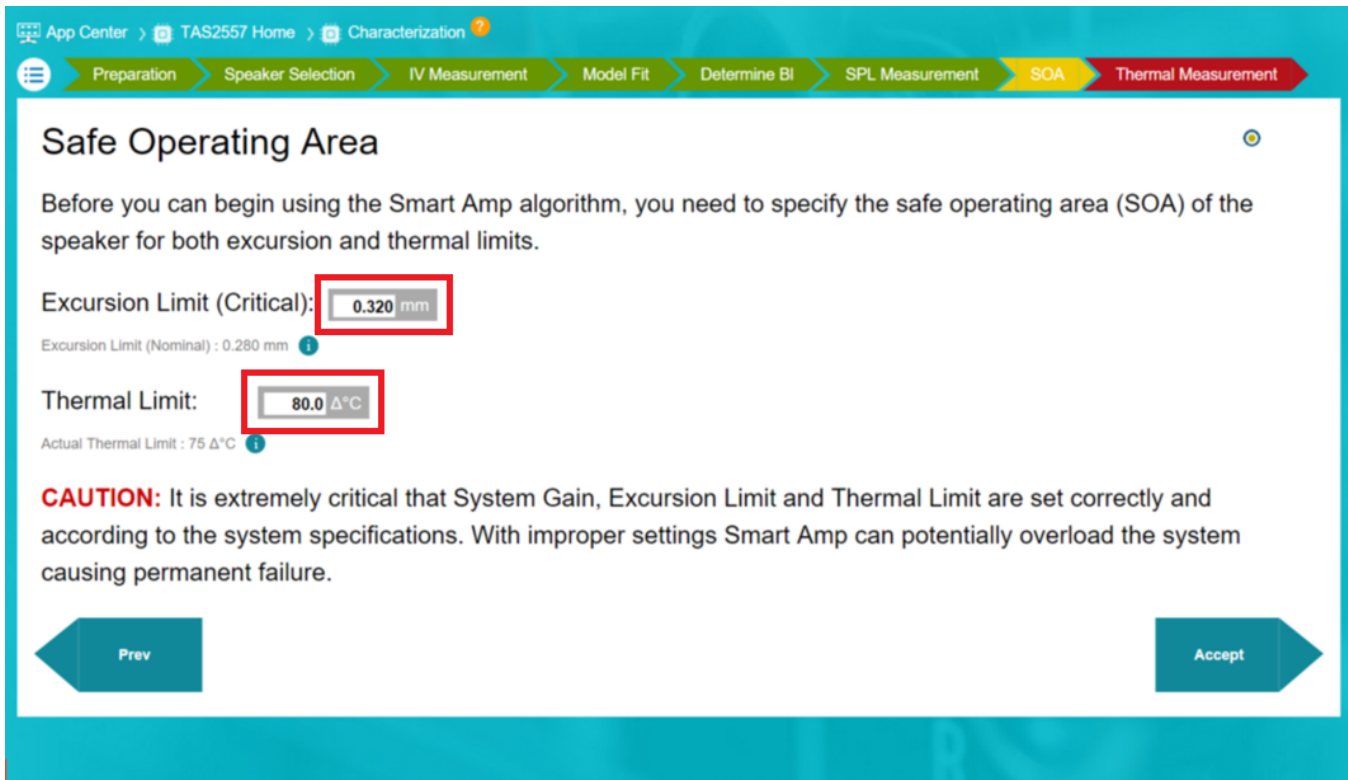

Figure 11. Safe Operating Area

9. Enter the Temperature Coefficient in the Thermal Characterization step Settings panel.
 - For larger speakers, the Controller settling correction and controller gain may need to be increased (seen in [Figure 12](#)). For example, for speakers with a power rating of 1 W, use a controller gain of 0.01, and for speakers with power rating between 2 W to 3 W, change the controller gain to 0.03.
 - Wait 30 minutes before performing the thermal characterization again on the same speaker unit so the speaker coil has time to cool down and reach the ambient temperature gain.

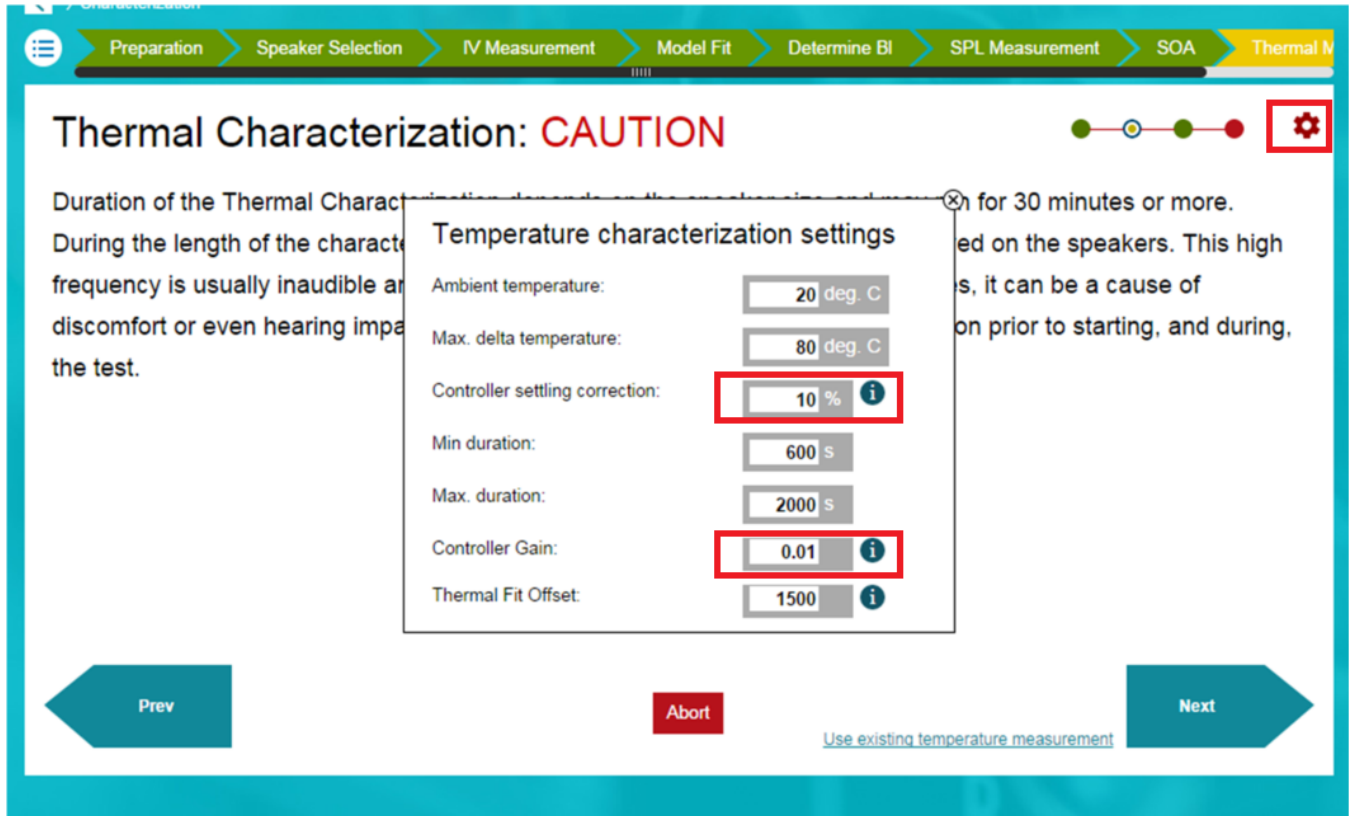

Figure 12. Thermal Characterization Step Settings

- Click on the Start Tuning icon after completing the speaker characterization process. This action directs users to the Tuning and Audio processing page and loads all of the speaker parameters to the TAS25xx (see Figure 13).

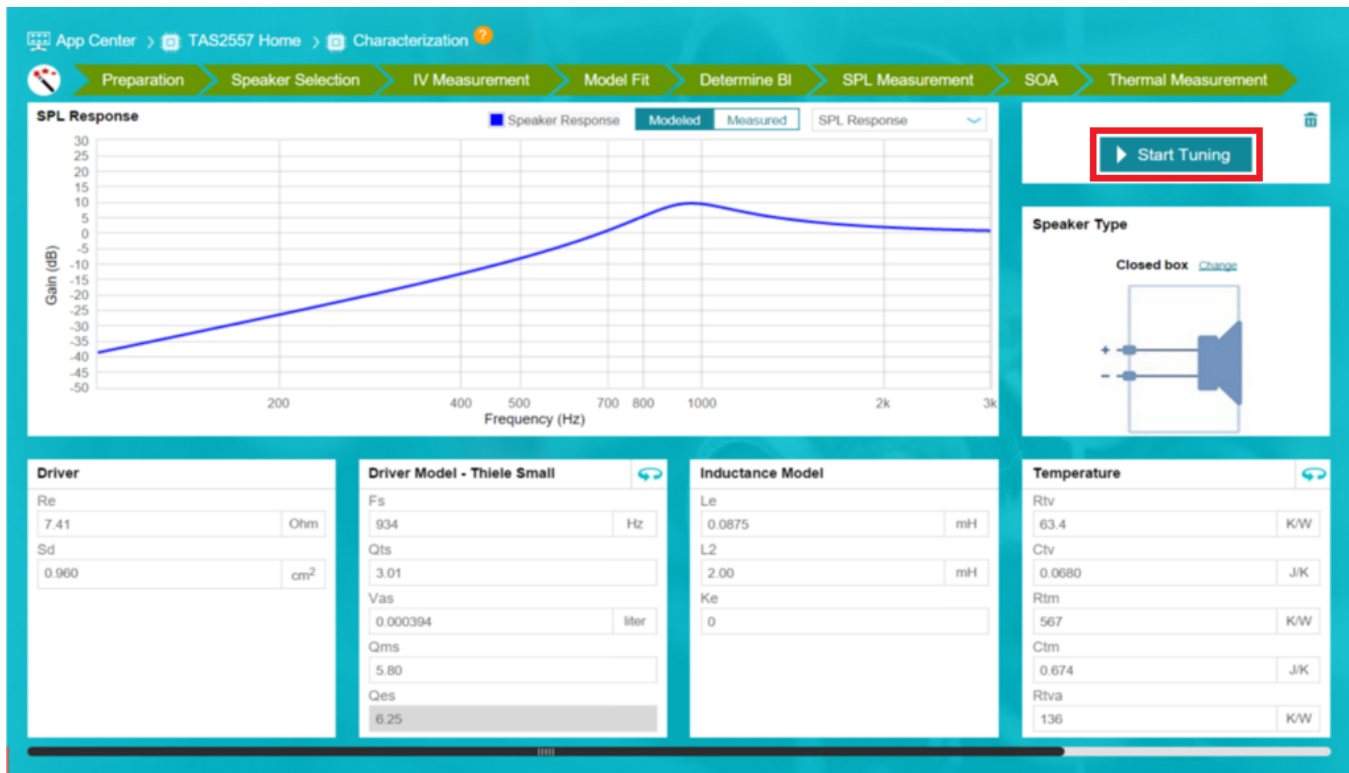

Figure 13. Speaker Characterization Results

The last step before users start tuning the speakers is to perform the speaker normalization. The speaker normalization is part of the Tuning and Audio processing page.

11. Perform the normalization (shown in Figure 14) by selecting Start Calibration (see Figure 15).

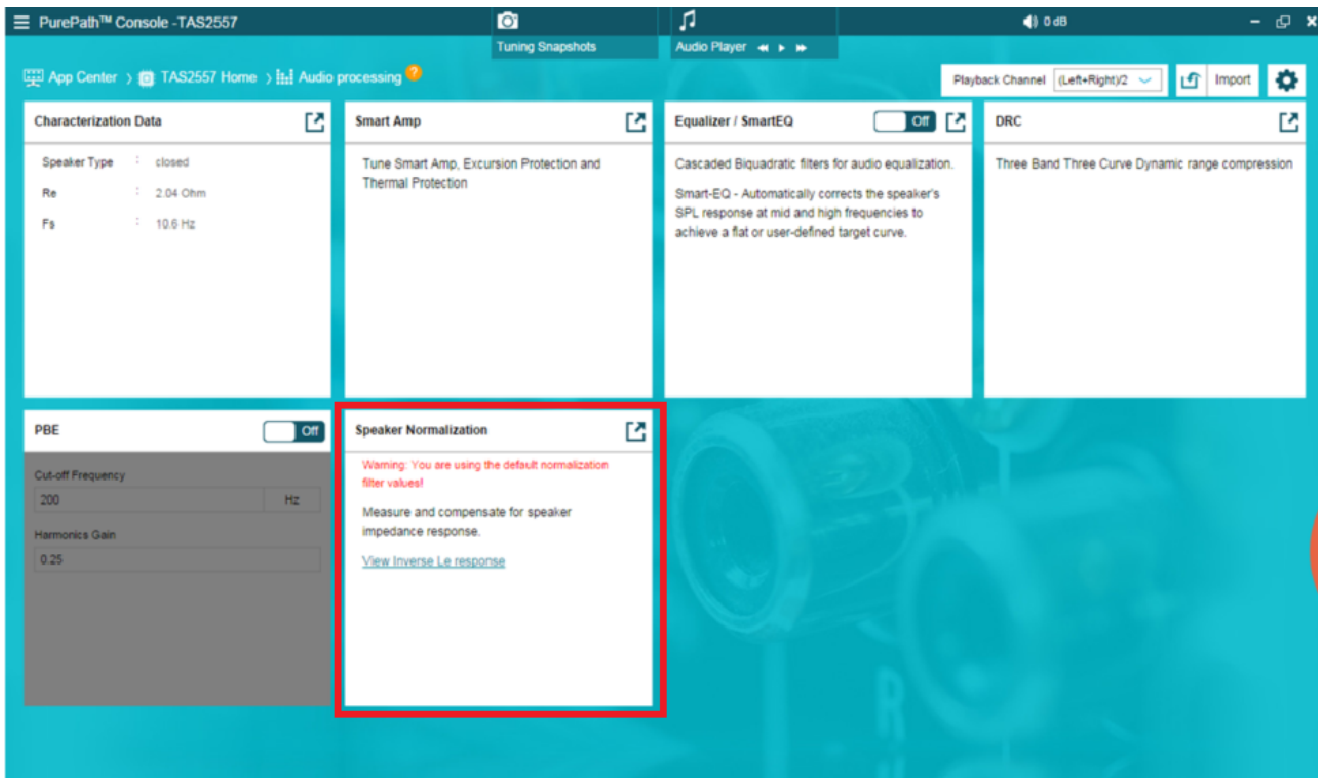

Figure 14. Speaker Normalization in Tuning and Audio Processing

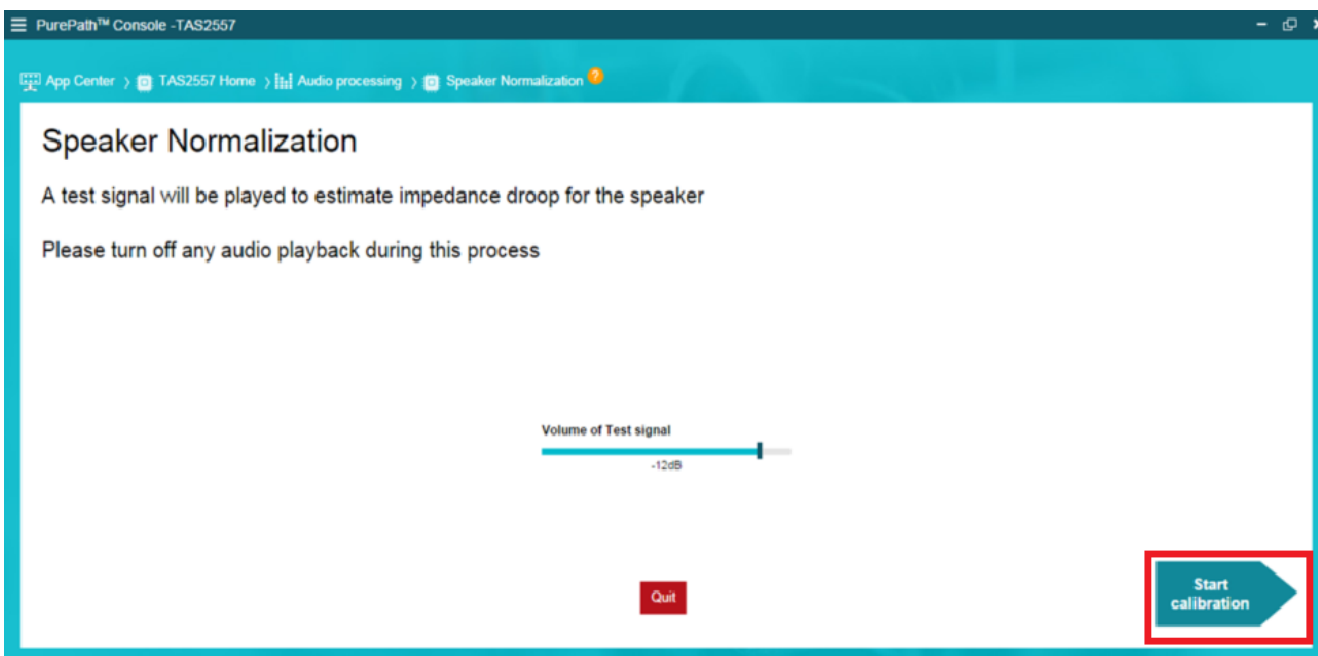

Figure 15. Start Calibration

Once completed, users should obtain a plot like the plot shown in [Figure 16](#).



Figure 16. Speaker Normalization Plot

5 Characterization Results

As discussed in the previous section, the characterization process is critical to properly model the speaker. Characterization results must be reviewed to verify proper speaker modeling.

The results from the characterization process will provide the following 3 plots: Impedance and Excursion, Temperature, and SPL.

- Impedance and Excursion Plot
 - The Impedance and Excursion plot will look similar to [Figure 17](#). In this plot, ensure there is a defined peak at the resonance frequency of the speaker as can be seen circled below. Please also ensure the Impedance plot matches the plot in the speaker data sheet. If the resonance frequency is below the specified value on the speaker data sheet, this could indicate that there is a leak on the speaker box. If there is more than one resonance frequency, it could mean that the speaker box has a port or a passive radiator.

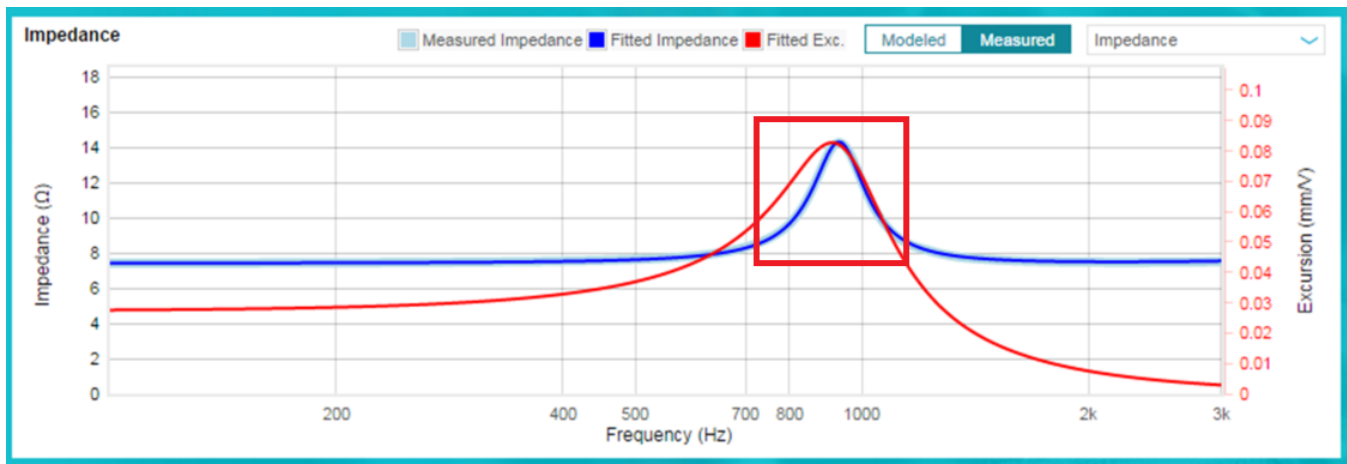

Figure 17. Impedance and Excursion Plot

- Temperature
 - The Temperature Plot from the characterization will look similar to [Figure 18](#). Ensure there the speaker heats up to the maximum temperature of the speaker which is 75°C in [Figure 18](#).

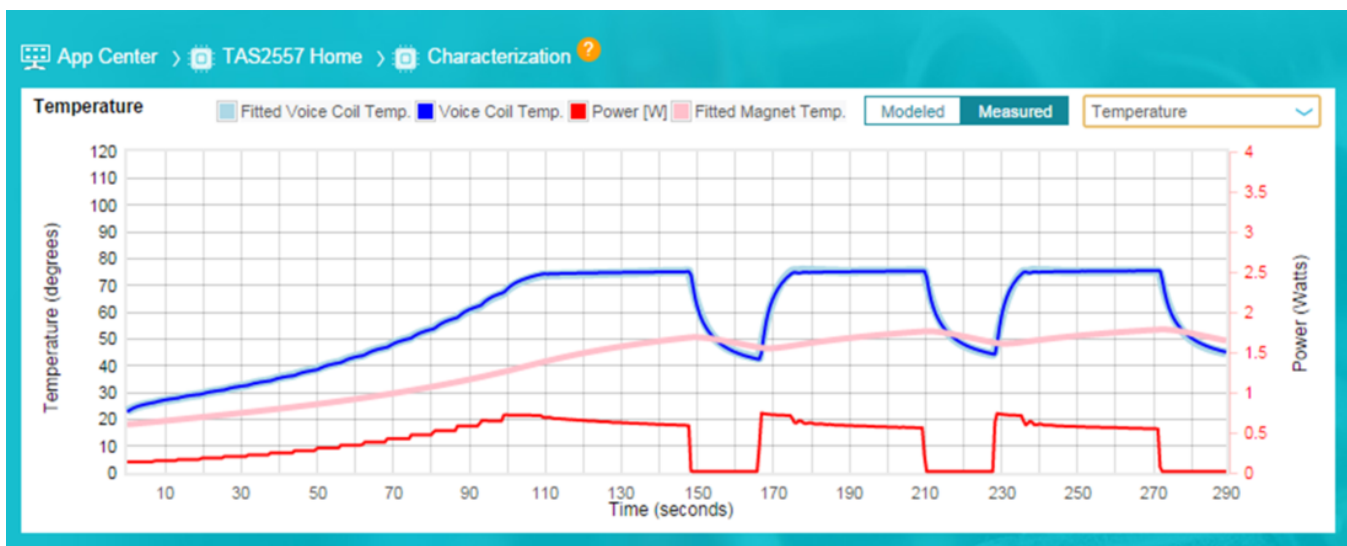

Figure 18. Temperature Plot

- SPL Plot
 - The SPL plot will look similar to the plot in [Figure 19](#). Lower frequencies (< 100 Hz) in the SPL plot show room noise, but they will not be used by the Smart Amp. To ensure the speaker is in a sealed enclosure (closed box), check to see if there is a peak at the resonance frequency of the speakers.

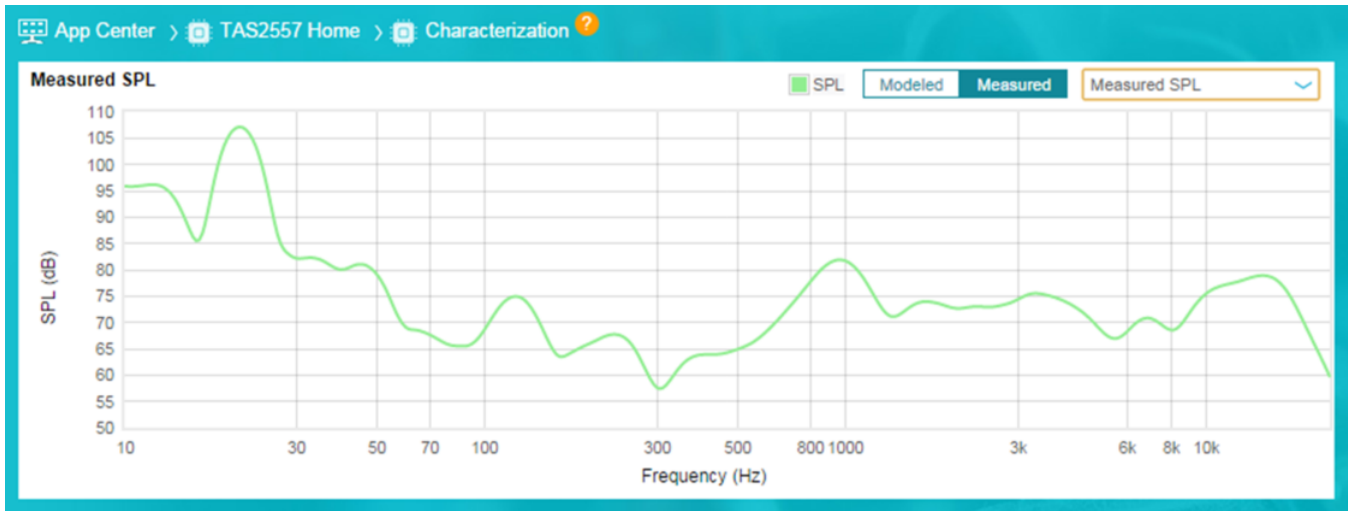

Figure 19. SPL Plot

6 Speaker Tuning

Application specific speaker tuning can be important in order to optimize the sound quality and SPL of a speaker. An example of this may be to have the highest quality sound for voice in a video doorbell or the highest quality of music in a portable speaker. TI's Smart Amp products allow custom speaker tuning all within the PPC3 Software GUI. PPC3 is an easy to use tool that enables speaker tuning using 10 biquads and features like Psychoacoustic Bass Enhancer, and Dynamic Range Compression to mention a few. For more information on the tuning process, please refer to the [Smart Amp Tuning Guide](#).

7 Schematic Review

The following section will provide the typical application of the TAS2557 Smart Amp device along with design tradeoffs to consider when planning the schematic of a Smart Amp product in an audio design.

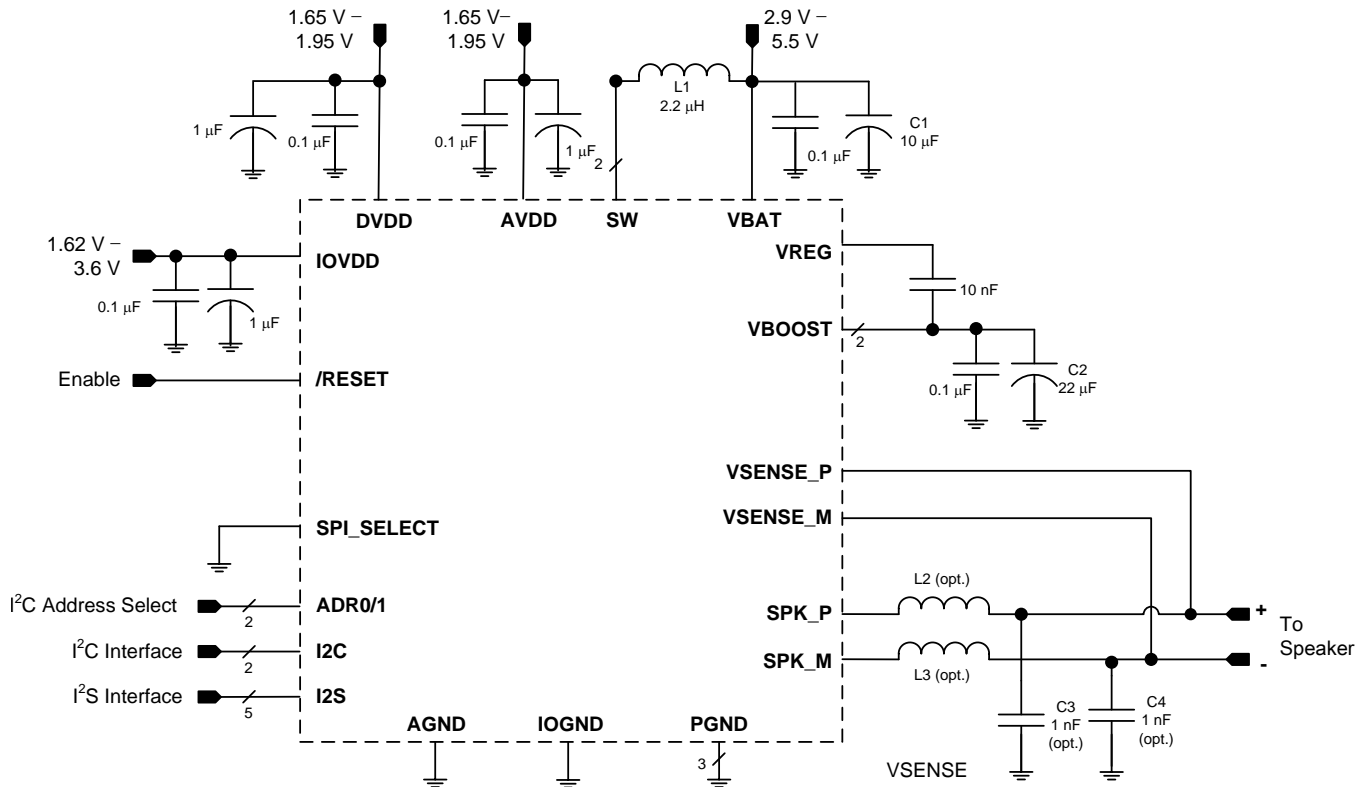

Figure 20. TAS2557 Typical Application

Table 3. Recommended External Components

Component	Description	Specification	MIN	TYP	MAX	Unit
L1	Boost converter inductor	Inductance, 20% tolerance	1	2.2		µH
		Saturation current		3.1		A
L2	EMI filter inductors (optional). These are not recommended because they degrade THD+N performance. The TAS2555 device is a filterless Class-D and does not require these bead inductors.	Impedance at 100 MHz		120		Ω
		DC resistance			0.095	
		DC current				2
L3		Size		0402		µF
C1	Boost converter input capacitor	Capacitance, 20% tolerance	10			µF
C2	Boost converter output capacitor	Type	X5R			
		Capacitance		22	47	µF
		Rated voltage		16		V
		Capacitance at 8.5-V derating		7		µF
C3	EMI filter capacitors (optional; must use L2 and L3 if C3 and C4 are used)	Capacitance		1		nF
C4						

7.1 Design Tradeoffs

- When selecting components, be aware of the derated values of capacitors and inductors and provide headroom for the desired voltage ratings.
 - Capacitors
 - Use capacitors with voltage rating of at least 2x the maximum DC voltage applied to the capacitor. Capacitance may change sharply depending on the applied voltage.
 - Review the temperature dependent characteristics for the capacitor. The capacitance may change with temperature changes.
 - Inductors
 - Verify the inductor rated saturation current meets design specifications.
 - Review the DC current bias dependent characteristics of the inductor. The inductance may change sharply depending on the applied current.
 - Review the frequency dependent characteristics of the inductor. The inductance may change sharply depending on the operating frequency.
- Ferrite bead filter
 - Pay close attention to the set resonance frequency of the filter.
 - Refer to [Filter-Free™ Class-D Audio Amplifiers](#) for more information on this filter.
- Removing decoupling capacitors
 - Removal can cause noise on the supply.
 - Removal can lead to transients that affect THD+N performance of the device.
 - Removal can lead to shutting down the device if transients dip too low and as a result trigger UVLO.
- Boost converter
 - The capacitor and inductor must be within data sheet guidelines to maintain a stable output voltage.
 - Derating of the capacitor and inductor at bias conditions is critical.
- Plan ahead for contingencies on nodes that may require additional filtering. For example, where EMI filters may be needed on amplifier outputs.
- It is recommended to have the schematic reviewed by a local TI resource, or by reaching out on the [TI E2E™ Community](#).

8 Layout Review

It is critical to plan the proper layout and schematic as mentioned in the previous section for the Smart Amp device in your audio design. This section provides typical layout guidelines for the TAS2557 and best practices to keep in mind when creating the layout.

- Place the boost inductor between VBAT and SW close to device terminals with no VIAS between the device terminals and the inductor.
- Place the capacitor between VREG and VBOOST close to device terminals with no VIAS between the device terminals and capacitor.
- Place the capacitor between VBOOST, VBAT, and GND close to device terminals with no VIAS between the device terminals and capacitor.
- Do not use VIAS for traces that carry high current. These include the traces for VBOOST, SW, VBAT, PGND and the speaker SPK_P, SPK_M.
- Use epoxy filled vias for the interior pads.
- Connect VSENSE+, VSENSE– as close as possible to the speaker.
 - VSENSE+, VSENSE– should be connected between the EMI ferrite filter and the speaker if EMI ferrites are used on SPK_P, SPK_M.
- If the analog inputs, IN_M and IN_P are (applicable on TAS2552 and TAS2555 devices):
 - used, analog input traces should be routed symmetrically for true differential performance.
 - used, do not run analog input traces parallel to digital lines.
 - used, they should be AC coupled.
 - not used, they should be grounded.
- Use a ground plane with multiple vias for each terminal to create a low-impedance connection to GND for minimum ground noise.
- Use supply decoupling capacitors as shown and described in [TAS2557 5.7-W Class-D Mono Audio Amplifier with Class-H Boost and Speaker Sense](#) data sheet.
- Place EMI ferrites, if used, close to the device.

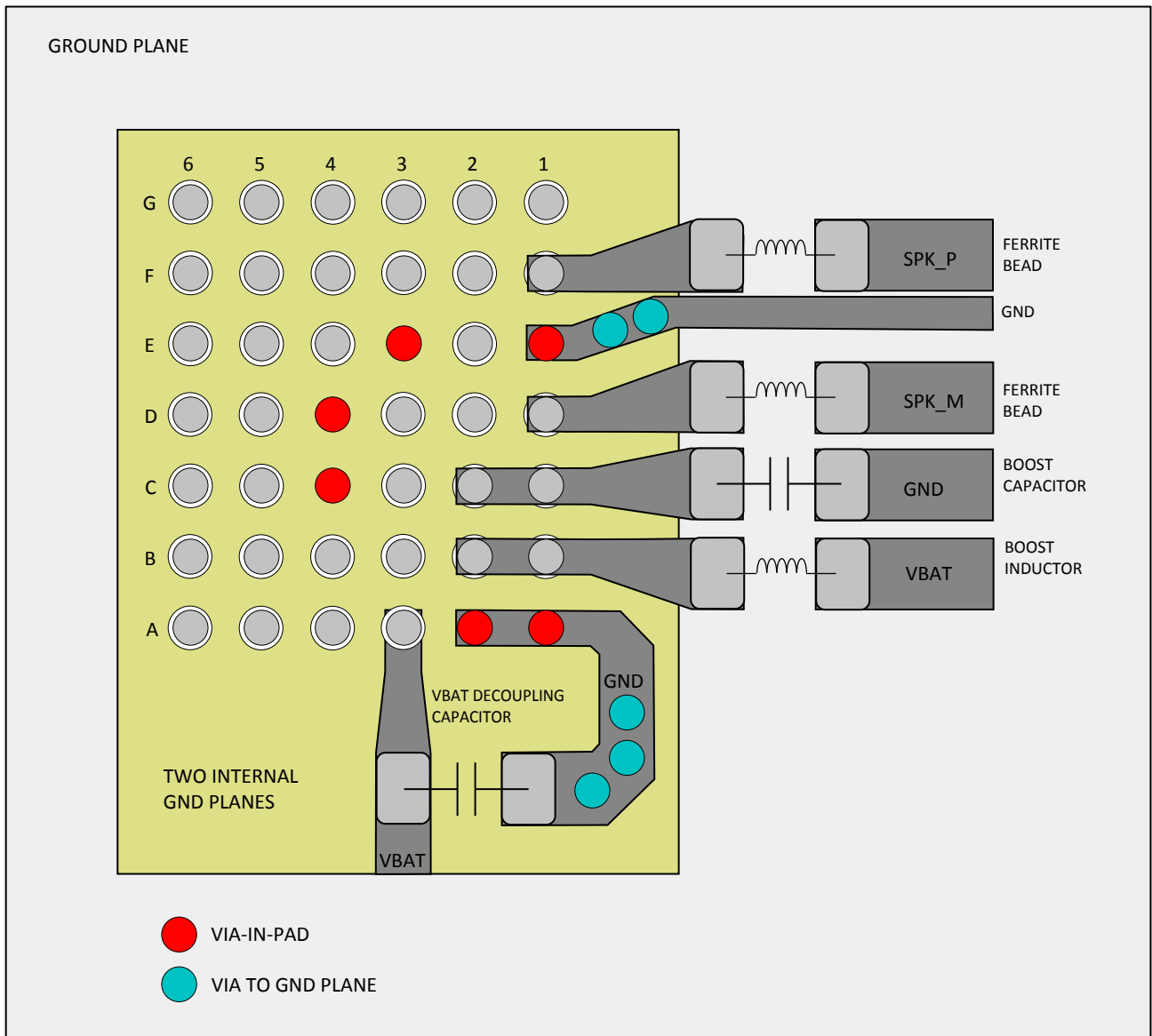

Figure 21. TAS2557 Layout Example

8.1 Best Practices

- Use blind vias and it is recommended to have them epoxy filled (conductive is preferred, but nonconductive is typically okay as long as inductance is $< 1 \mu\text{H}$).
- Boost elements paths should be as short as possible and traces as wide as possible.
- When vias are needed use multiple to reduce impedance.
- Plan ahead for EMI
 - Use clean power supply routing.
 - Traces on switching signals should be as short as possible.
 - Use shielding where possible on digital signals and outputs.
- Plan for proper heat dissipation of the device.
- Use traces that are as large as possible for high current paths (Boost, Power, Output, GND).
- Place the decoupling capacitors as close as possible to the device
- VBOOST, SW, Outputs (OUT+ and OUT–)
 - Route these signals with at least two parallel routes on two different layers along with at least two vias.
 - Use the shortest path possible.
 - Feedback path (VSENSE+ and VSENSE–) from both outputs should be the same length and as far out along the outputs as possible.
- Avoid routing clocks near sensitive analog signals because this can introduce noise into the signals
- Active clocks routed close together may couple into each other causing clocking errors.
- For differential traces, route traces as close as possible and shield where possible.
- Reduce the impedance on VBAT.
- It is recommended to have the layout reviewed by a local TI resource or by reaching out on the [TI E2E Community](#).

9 Factory Test and Calibration (FTC) Implementation

Speaker parameters can vary from the vendor data sheet. This can lead to inaccurate speaker protection in situations where one speaker model is used to fit all speakers. For this reason TI's Smart Amp algorithm can be calibrated to the specific speaker parameters in order to ensure protection of the speaker on a speaker by speaker basis.

The FTC is performed to calibrate the Smart Amp algorithm and protect the speaker from speaker parameter variations. The FTC obtains the speaker R_e , f_0 , Q , and Voice Coil temperature as seen below in step three of FTC Process in [Figure 22](#).

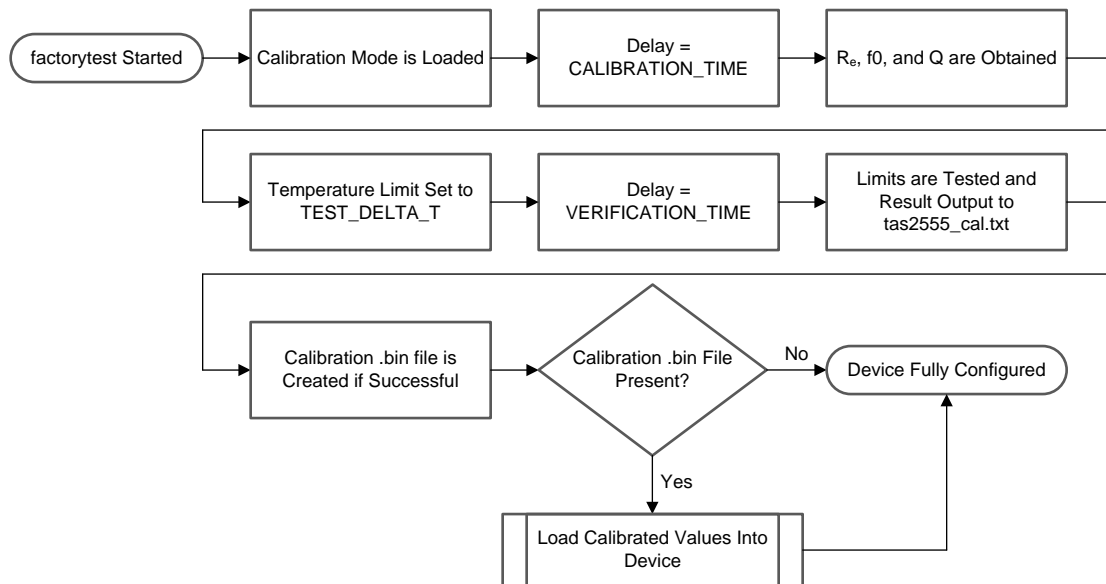

Figure 22. FTC Process Overview

These parameters are then compared against pass/fail limits defined by the customer along with updating the speaker model to the correct R_e as seen in the last step of [Figure 22](#). TI recommends the FTC is performed on all units in order to ensure protection of the speaker. For information on how to implement the FTC in your system please refer to the [TAS2555](#), [TAS2557](#), and [TAS2559 Factory Test and Calibration Guide](#).

9.1 Defining Pass and Fail Limits

The Pass / Fail Limits, which are shown in [Figure 23](#), are defined by the customer.

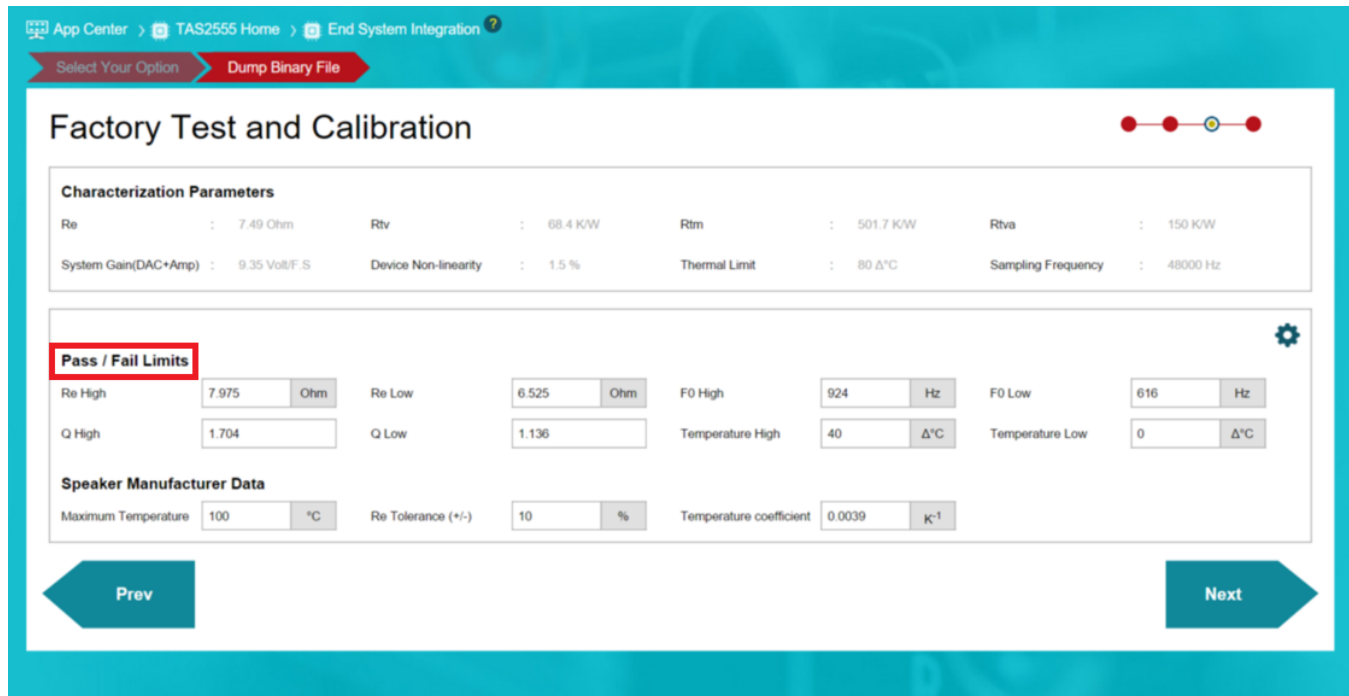

Figure 23. Factory Test and Calibration Step

Some good measures to take when defining these limits are to use the speaker vendor Re variations as the limits for Re while using 6-Sigma as the variation limits for the rest of the speaker parameters. The Re plot below shows a variation limit of ± 0.6 for a 6- Ω speaker with the $\pm 10\%$ variation obtained from the speaker vendor. These limits are shown with the solid black lines at 6.6 and 5.4 (see Figure 24).

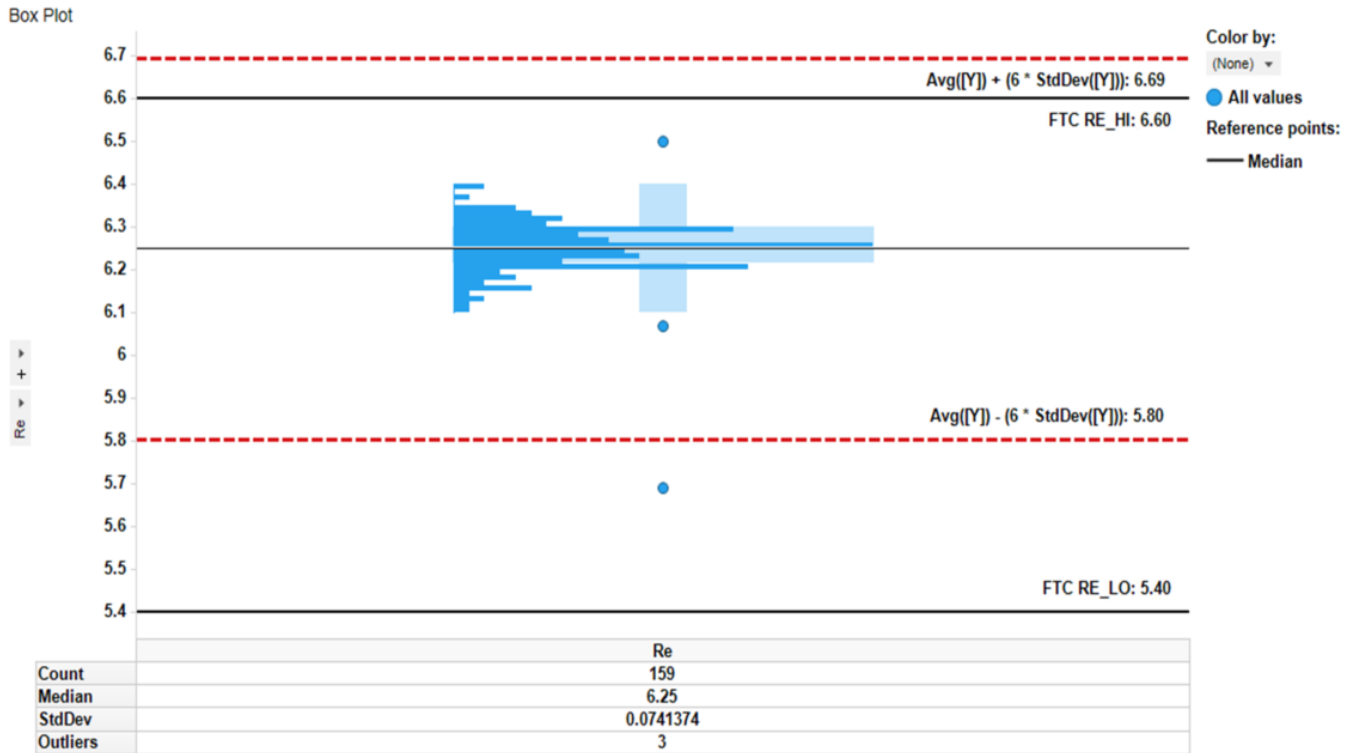

Figure 24. Re Variation Limits

The remainder of the plots show the *Pass / Fail Limits* defined based on the 6-Sigma Distribution (see Figure 25, Figure 26, and Figure 27). These limits are shown by the red dotted lines.

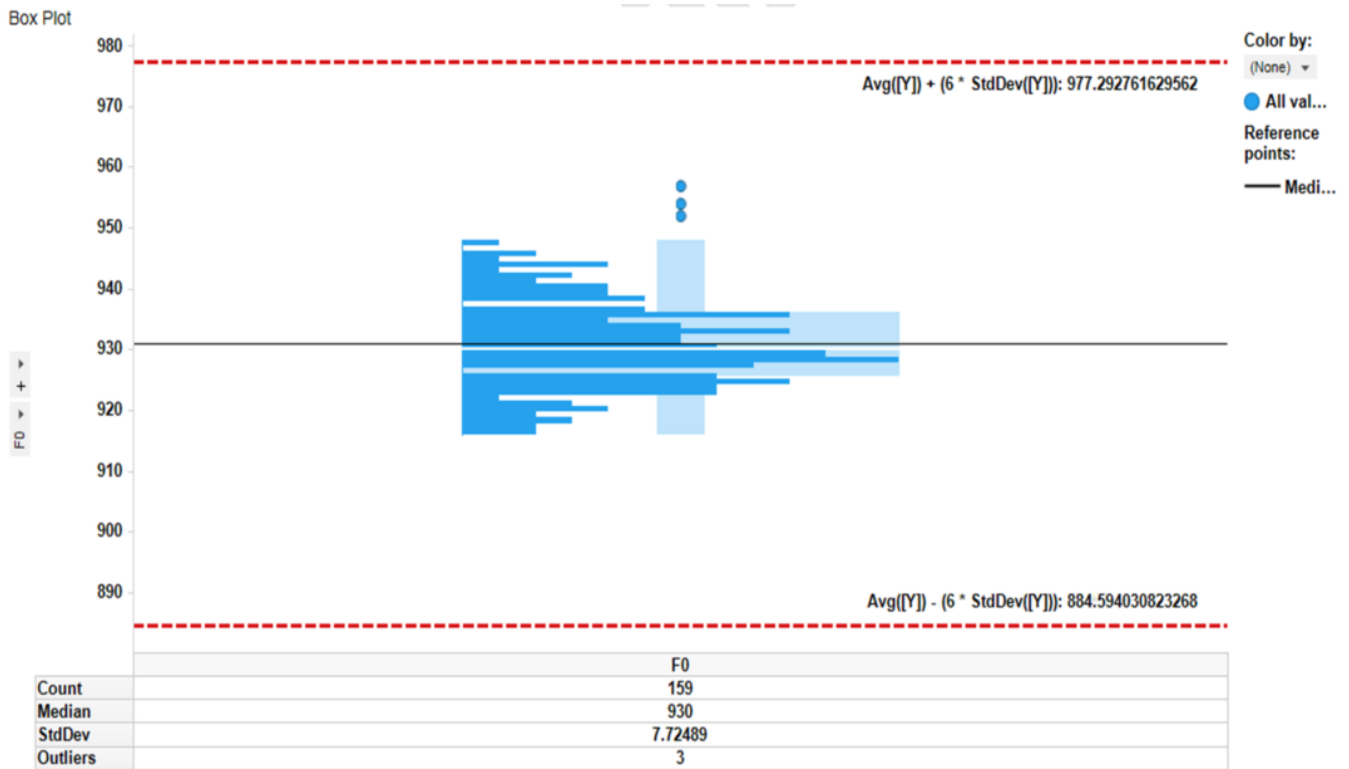

Figure 25. f0 Variation Limits

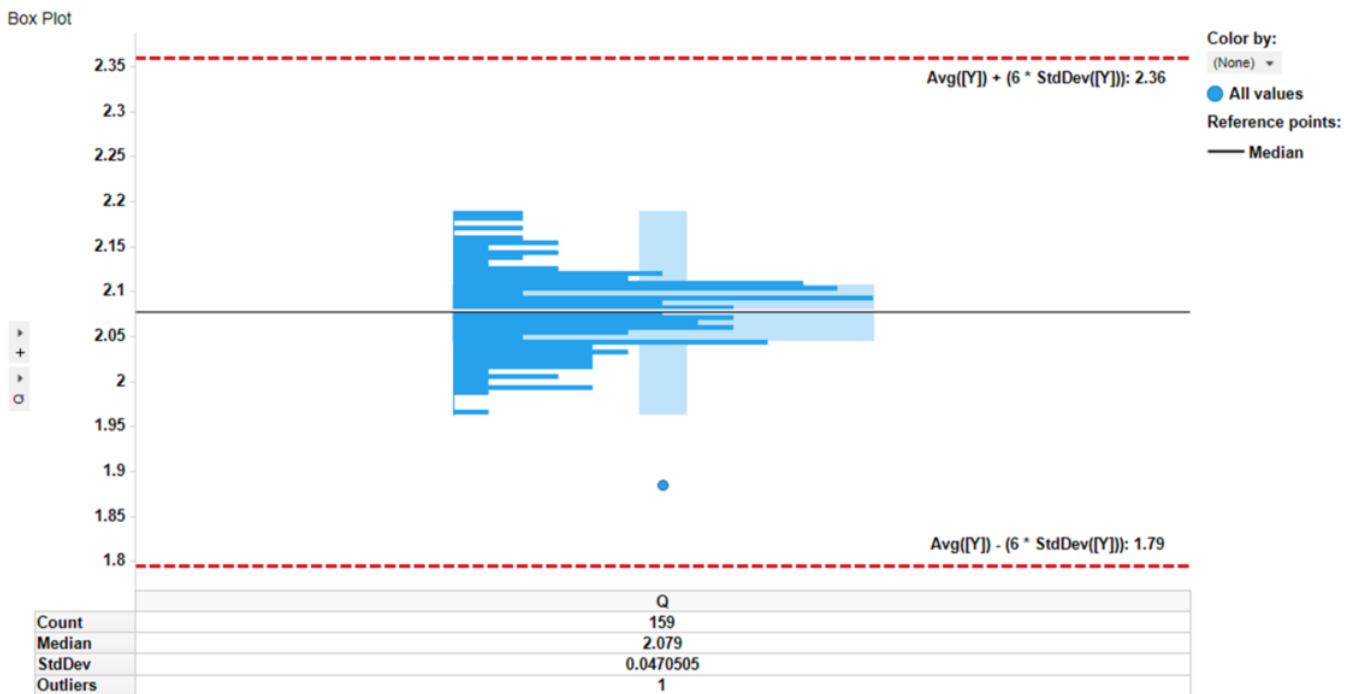

Figure 26. Q Variation Limits

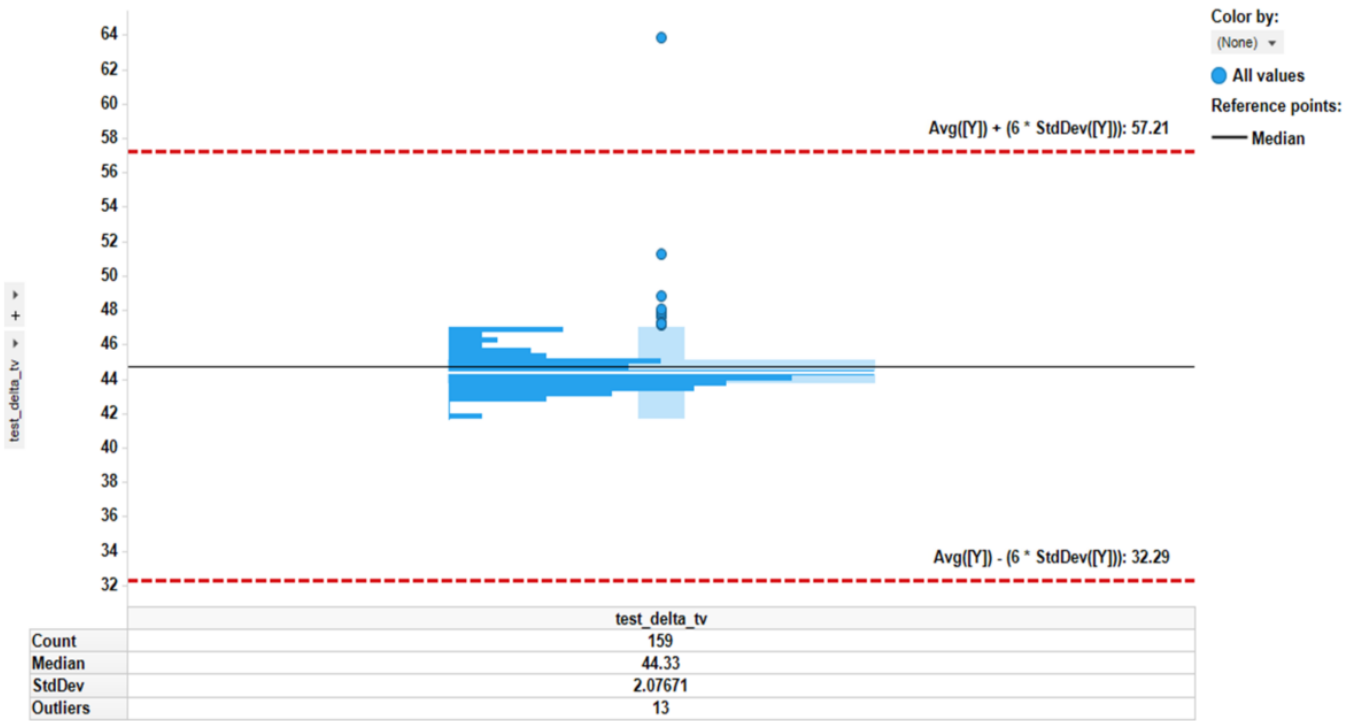

Figure 27. ΔT Variation Limits

10 System Integration Guidance

The End System Integration step creates the final binary file for the end system driver to load. Sample drivers for the end system can be found at the following: 1, 2.

1. Obtain the FTC Pass / Fail Limits from [Section 9.1](#) and select End System Integration in the home page.

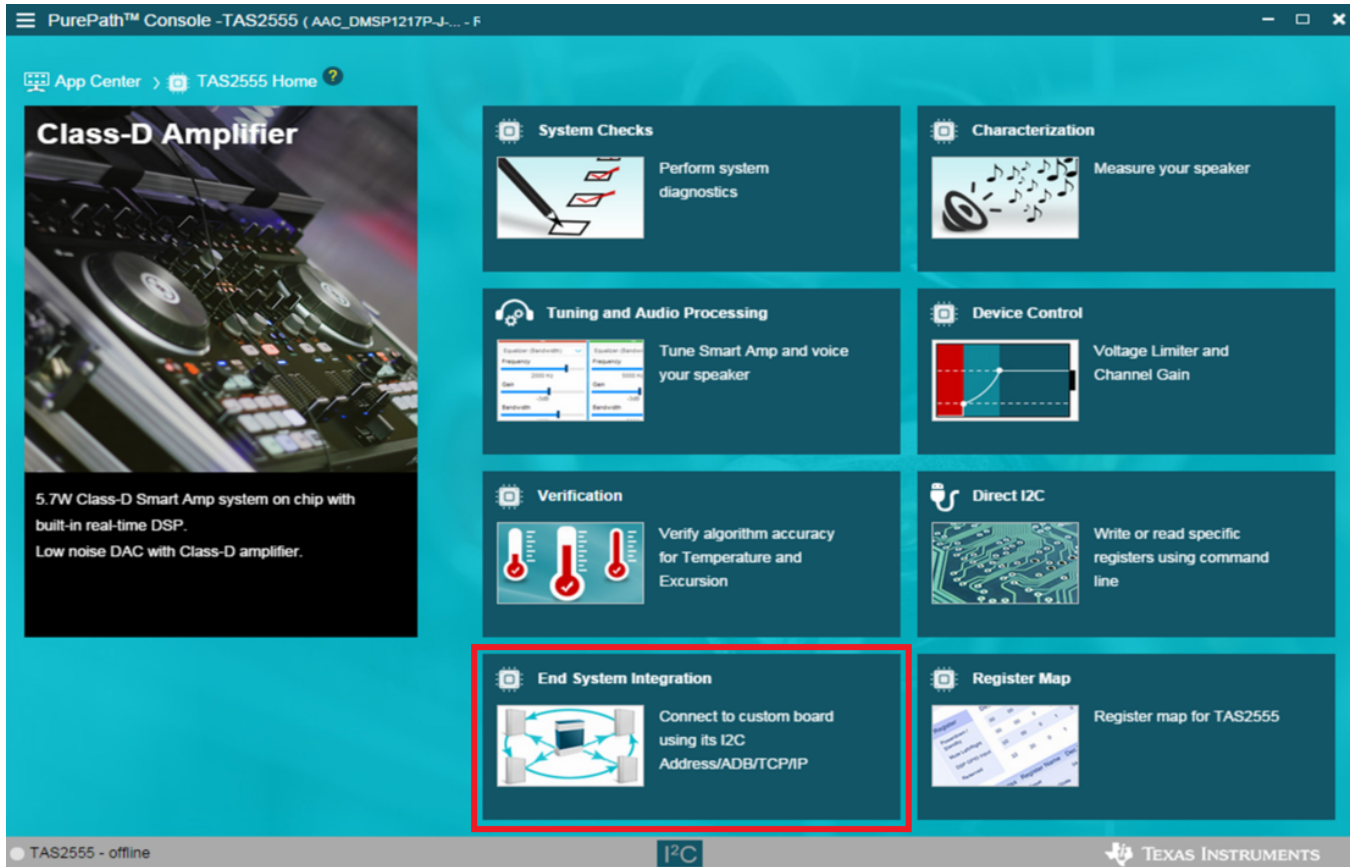

Figure 28. End-System Integration (1 of 2)

2. Select *Dump the Binary File* to continue to the next step (see [Figure 29](#)).

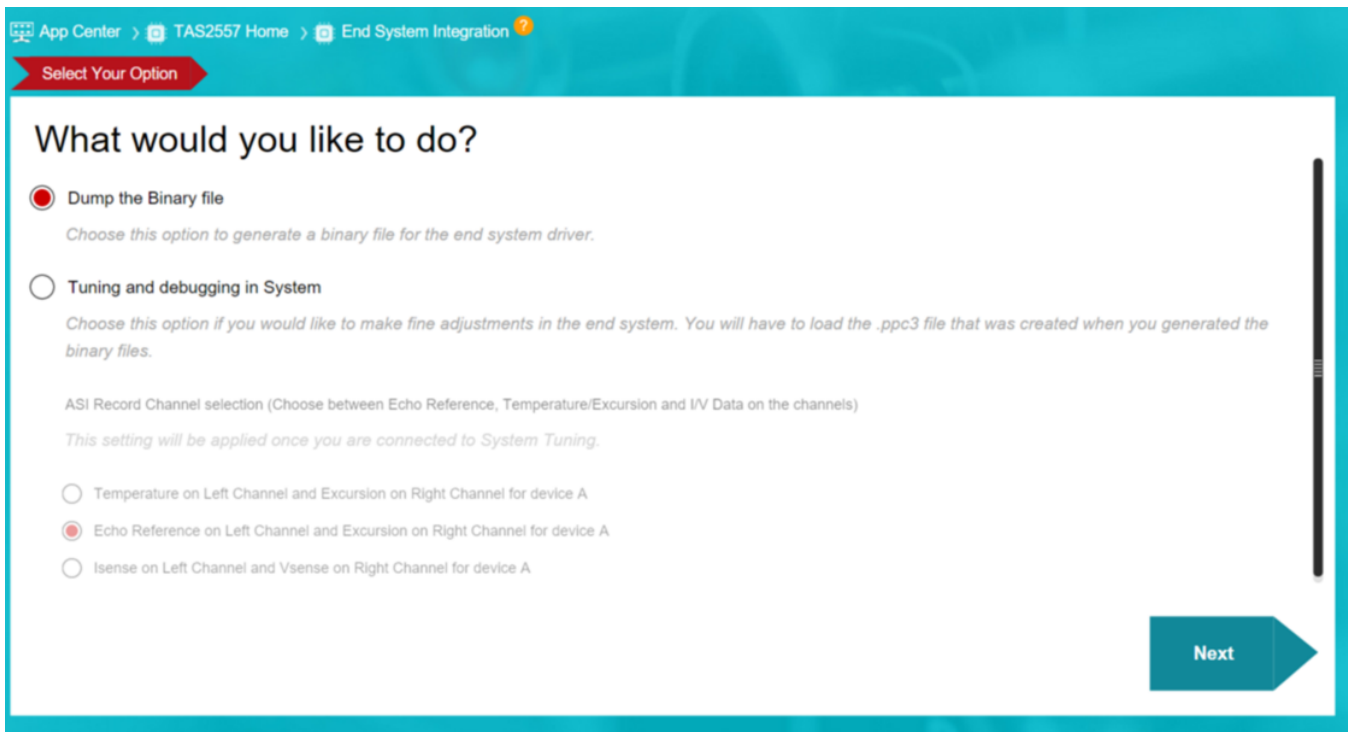

Figure 29. End-System Integration (2 of 2)

3. Select the settings used in the final system, such as: Application, Sampling Frequency, Clock Source, and Clock Frequency. For example, if MCLK is used as the clock source, then this must be selected in the Clock Source section to correctly configure the device.

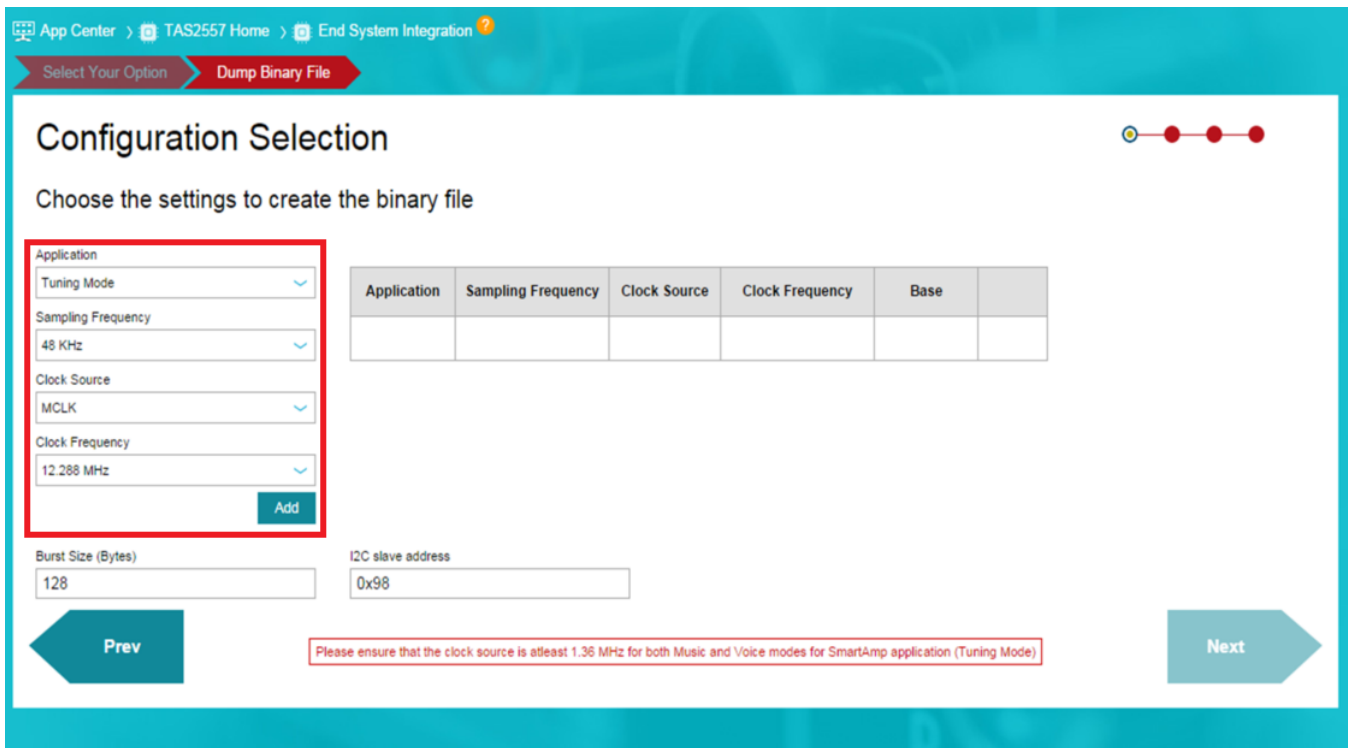

Figure 30. Configuration Selection

4. Save the files to a selected folder after the configuration is selected, then click *Next*.

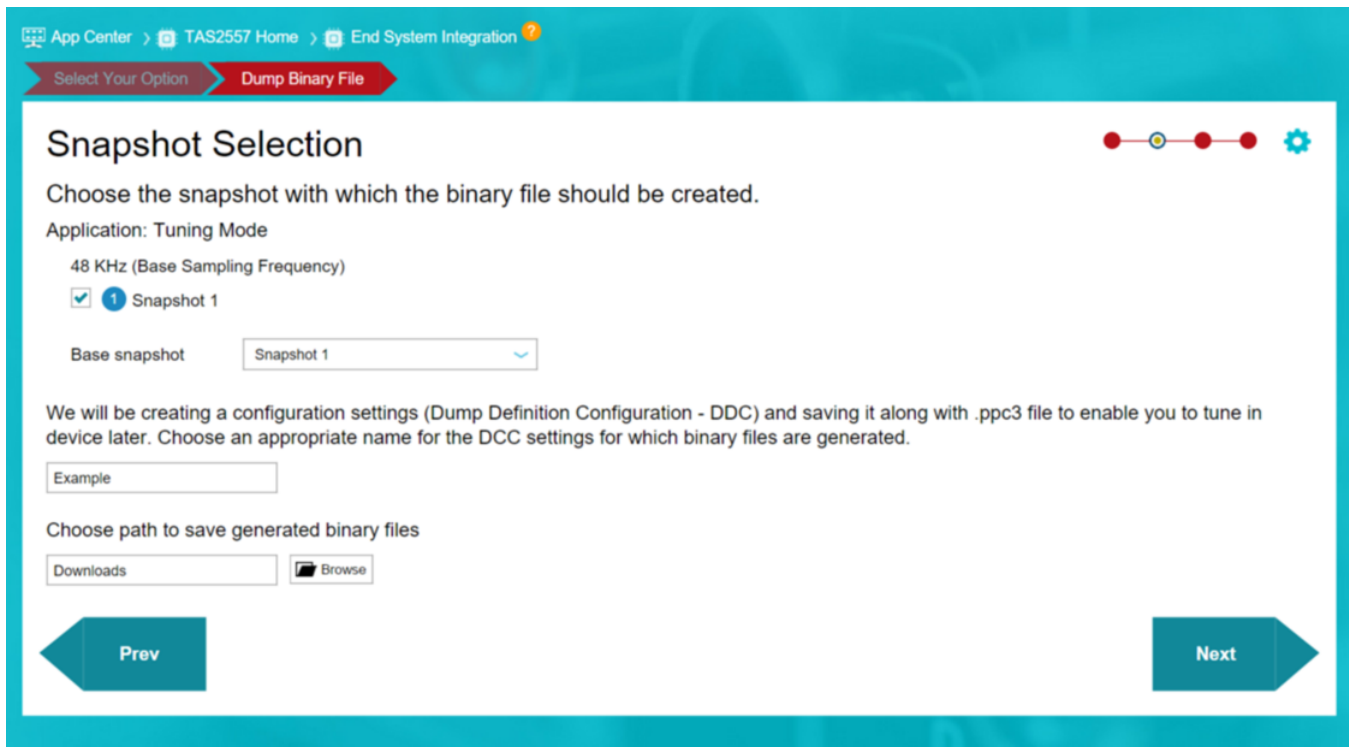

Figure 31. Snapshot Selection

5. Enter the pass and fail limits that were determined in the FTC step, then click *Dump* to dump the final binary files.

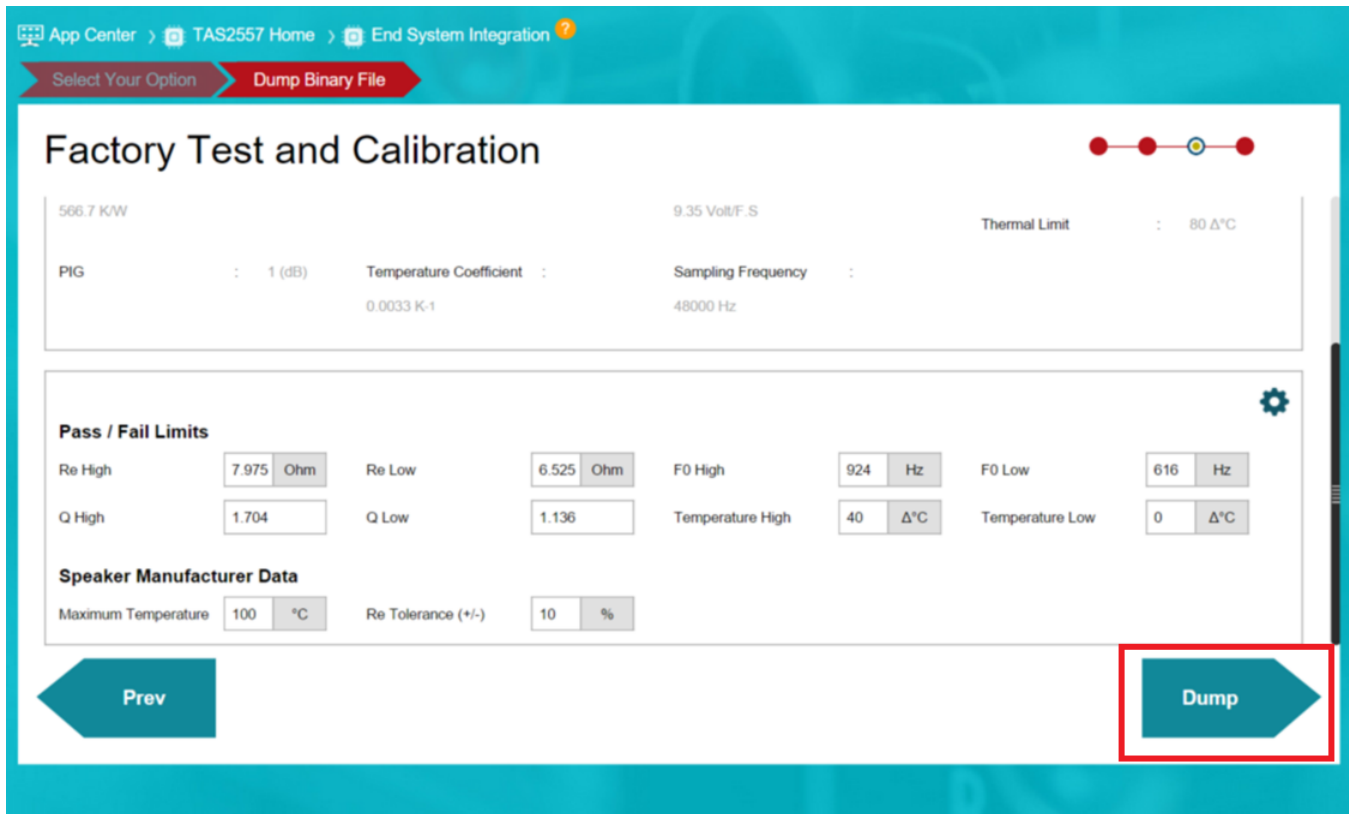

Figure 32. FTC Pass / Fail Limits

For more information on the End System Integration process, refer to [TAS2555 End-System Integration Guide](#) or [TAS2555, TAS2557, and TAS2559 Factory Test and Calibration Guide](#).

The final step of the Smart Amp Process is the End System Integration Step. Once this step is complete, users will be on your way in using TI's Smart Amp devices to drive the audio requirements of the system. Please reach out to TI on the [TI E2E Community](#).

Revision History

NOTE: Page numbers for previous revisions may differ from page numbers in the current version.

Date	Revision	Description
August 2017	*	Initial release

IMPORTANT NOTICE FOR TI DESIGN INFORMATION AND RESOURCES

Texas Instruments Incorporated ("TI") technical, application or other design advice, services or information, including, but not limited to, reference designs and materials relating to evaluation modules, (collectively, "TI Resources") are intended to assist designers who are developing applications that incorporate TI products; by downloading, accessing or using any particular TI Resource in any way, you (individually or, if you are acting on behalf of a company, your company) agree to use it solely for this purpose and subject to the terms of this Notice.

TI's provision of TI Resources does not expand or otherwise alter TI's applicable published warranties or warranty disclaimers for TI products, and no additional obligations or liabilities arise from TI providing such TI Resources. TI reserves the right to make corrections, enhancements, improvements and other changes to its TI Resources.

You understand and agree that you remain responsible for using your independent analysis, evaluation and judgment in designing your applications and that you have full and exclusive responsibility to assure the safety of your applications and compliance of your applications (and of all TI products used in or for your applications) with all applicable regulations, laws and other applicable requirements. You represent that, with respect to your applications, you have all the necessary expertise to create and implement safeguards that (1) anticipate dangerous consequences of failures, (2) monitor failures and their consequences, and (3) lessen the likelihood of failures that might cause harm and take appropriate actions. You agree that prior to using or distributing any applications that include TI products, you will thoroughly test such applications and the functionality of such TI products as used in such applications. TI has not conducted any testing other than that specifically described in the published documentation for a particular TI Resource.

You are authorized to use, copy and modify any individual TI Resource only in connection with the development of applications that include the TI product(s) identified in such TI Resource. NO OTHER LICENSE, EXPRESS OR IMPLIED, BY ESTOPPEL OR OTHERWISE TO ANY OTHER TI INTELLECTUAL PROPERTY RIGHT, AND NO LICENSE TO ANY TECHNOLOGY OR INTELLECTUAL PROPERTY RIGHT OF TI OR ANY THIRD PARTY IS GRANTED HEREIN, including but not limited to any patent right, copyright, mask work right, or other intellectual property right relating to any combination, machine, or process in which TI products or services are used. Information regarding or referencing third-party products or services does not constitute a license to use such products or services, or a warranty or endorsement thereof. Use of TI Resources may require a license from a third party under the patents or other intellectual property of the third party, or a license from TI under the patents or other intellectual property of TI.

TI RESOURCES ARE PROVIDED "AS IS" AND WITH ALL FAULTS. TI DISCLAIMS ALL OTHER WARRANTIES OR REPRESENTATIONS, EXPRESS OR IMPLIED, REGARDING TI RESOURCES OR USE THEREOF, INCLUDING BUT NOT LIMITED TO ACCURACY OR COMPLETENESS, TITLE, ANY EPIDEMIC FAILURE WARRANTY AND ANY IMPLIED WARRANTIES OF MERCHANTABILITY, FITNESS FOR A PARTICULAR PURPOSE, AND NON-INFRINGEMENT OF ANY THIRD PARTY INTELLECTUAL PROPERTY RIGHTS.

TI SHALL NOT BE LIABLE FOR AND SHALL NOT DEFEND OR INDEMNIFY YOU AGAINST ANY CLAIM, INCLUDING BUT NOT LIMITED TO ANY INFRINGEMENT CLAIM THAT RELATES TO OR IS BASED ON ANY COMBINATION OF PRODUCTS EVEN IF DESCRIBED IN TI RESOURCES OR OTHERWISE. IN NO EVENT SHALL TI BE LIABLE FOR ANY ACTUAL, DIRECT, SPECIAL, COLLATERAL, INDIRECT, PUNITIVE, INCIDENTAL, CONSEQUENTIAL OR EXEMPLARY DAMAGES IN CONNECTION WITH OR ARISING OUT OF TI RESOURCES OR USE THEREOF, AND REGARDLESS OF WHETHER TI HAS BEEN ADVISED OF THE POSSIBILITY OF SUCH DAMAGES.

You agree to fully indemnify TI and its representatives against any damages, costs, losses, and/or liabilities arising out of your non-compliance with the terms and provisions of this Notice.

This Notice applies to TI Resources. Additional terms apply to the use and purchase of certain types of materials, TI products and services. These include; without limitation, TI's standard terms for semiconductor products (<http://www.ti.com/sc/docs/stdterms.htm>), [evaluation modules](#), and [samples](http://www.ti.com/sc/docs/sampterm.htm) (<http://www.ti.com/sc/docs/sampterm.htm>).

Mailing Address: Texas Instruments, Post Office Box 655303, Dallas, Texas 75265
Copyright © 2017, Texas Instruments Incorporated