

TAS5782M Process Flows

Andy Liu (AIP)

ABSTRACT

The TAS5782M device has a powerful μ CDSP audio processing core, which supports several selectable process flows. This application report explains details of each process flow.

The TAS5782M process flows with standard processing, feature a few advanced audio processing blocks: *Dynamic Ranger Control (DRC)*, *Automatic Gain Limiter (AGL)*, *Dynamic Parametric Equalizer (DPEQ)* and *Spatializer*. A 3-band DRC + AGL structure limits the output power of the amplifier for three regions while controlling the peaking that can occur in the crossover region during compression. DPEQ dynamically adjusts the equalization curve that is applied to low-level signal and the curve that is applied to high level signals. Spatializer increases the field of sound for a broader and more encompassing audio experience.

TAS5782M process flows with *SmartAmp Processing* replaces traditional continuous power design principles and hardware-based speaker protection methods with algorithms that allow significant increases in peak power output, loudness, and sound quality relative to conventional amplifiers. *Smart Amp* tools allow developers to understand how speakers are performing in the system and then make informed decisions to improve performance. The algorithms, characterization, and tuning tools allow developers to overcome a wide variety of audio challenges.

Contents

| | | |
|---|--|----|
| 1 | General Overview..... | 3 |
| 2 | Process Flows Cross Reference..... | 5 |
| 3 | Process Flow 1 (96 kHz, 2.0 Standard Processing) | 6 |
| 4 | Process Flow 2 (96 kHz, 2.0 SmartAmp Processing)..... | 8 |
| 5 | Process Flow 3 (48 kHz, 2.0 Standard Processing) | 10 |
| 6 | Process Flow 4 (48 kHz, 2.0 SmartAmp Processing) | 12 |
| 7 | Process Flow 5 (48 kHz, 2.1 Standard Processing) | 14 |
| 8 | Process Flow 6 (48 kHz, 2.1 SmartAmp Processing) | 16 |
| 9 | Audio Processing Blocks | 18 |
| 10 | Smart Amp | 32 |
| 11 | Loudspeaker Characterization..... | 36 |
| 12 | Smart Amp Tuning | 39 |
| Appendix A DSP Memory Map..... | | 46 |
| Appendix B Power-Up and Power-Down Sequence | | 87 |

List of Figures

| | | |
|---|---|----|
| 1 | TAS5782M Functional Block Diagram | 3 |
| 2 | Process Flow 1..... | 6 |
| 3 | Process Flow 2..... | 8 |
| 4 | Process Flow 3 | 10 |
| 5 | Process Flow 4 | 12 |
| 6 | Process Flow 5 | 14 |
| 7 | Process Flow 5 | 16 |
| 8 | Input Mixer | 18 |
| 9 | Input Mixer (Basic Tab)..... | 18 |

| | | |
|----|--|----|
| 10 | Input Mixer (Advanced Tab) | 19 |
| 11 | Cascaded BQ Structure | 19 |
| 12 | Equalizer Tuning Window | 20 |
| 13 | Volume..... | 21 |
| 14 | Volume Attack and Decay | 21 |
| 15 | Spatializer Block Diagram | 22 |
| 16 | Spatializer Tuning Window..... | 22 |
| 17 | DPEQ | 23 |
| 18 | DPEQ Tuning Window..... | 24 |
| 19 | Bass Mono Mixer..... | 25 |
| 20 | 3-Band DRC | 25 |
| 21 | DRC Attack and Decay..... | 26 |
| 22 | DRC Tuning Window | 26 |
| 23 | AGL Tuning Window | 27 |
| 24 | AGL Attack and Release | 28 |
| 25 | Crossover Tuning Window | 29 |
| 26 | Phase Delay Tuning Window..... | 30 |
| 27 | Clipper | 30 |
| 28 | Output Crossbar (Basic Tab) | 31 |
| 29 | Output Crossbar (Advanced Tab)..... | 31 |
| 30 | Audio Clip A, 22-dB Peak-to-Average Ratio Source | 32 |
| 31 | Audio Clip B, 9-dB Peak-to-Average Ratio Source | 32 |
| 32 | PurePath™ Smart Amp Block Diagram | 33 |
| 33 | Smart Amp Development Overview | 34 |
| 34 | Smart Amp Tuning Process..... | 39 |
| 35 | Smart Amp Tuning Page | 42 |
| 36 | Power-Up Timing..... | 87 |
| 37 | Power-Down Timing | 88 |

List of Tables

| | | |
|----|--|----|
| 1 | Supported Use Cases..... | 4 |
| 2 | Process Flows 1–4 | 5 |
| 3 | Process Flows 5–6 | 5 |
| 4 | BQ Coefficients Normalization..... | 19 |
| 5 | Recommended Presets Available in the GUI..... | 23 |
| 6 | Bass Enhancement Parameters | 43 |
| 7 | DSP Memory Map for Process Flow 1 — Book 0x8C..... | 46 |
| 8 | DSP Memory Map for Process Flow 2 — Book 0x8C..... | 51 |
| 9 | DSP Memory Map for Process Flow 3 — Book 0x8C..... | 56 |
| 10 | DSP Memory Map for Process Flow 4 — Book 0x8C..... | 63 |
| 11 | DSP Memory Map for Process Flow 5 — Book 0x8C..... | 70 |
| 12 | DSP Memory Map for Process Flow 6 — Book 0x8C..... | 79 |

Trademarks

PurePath is a trademark of Texas Instruments.
All other trademarks are the property of their respective owners.

1 General Overview

In the signal processing path, a μ CDSP audio processing core is placed after the Serial Audio Port and before the Digital-to-Analog Converter (DAC), which precedes the Class D amplifier. This is illustrated in Figure 1.

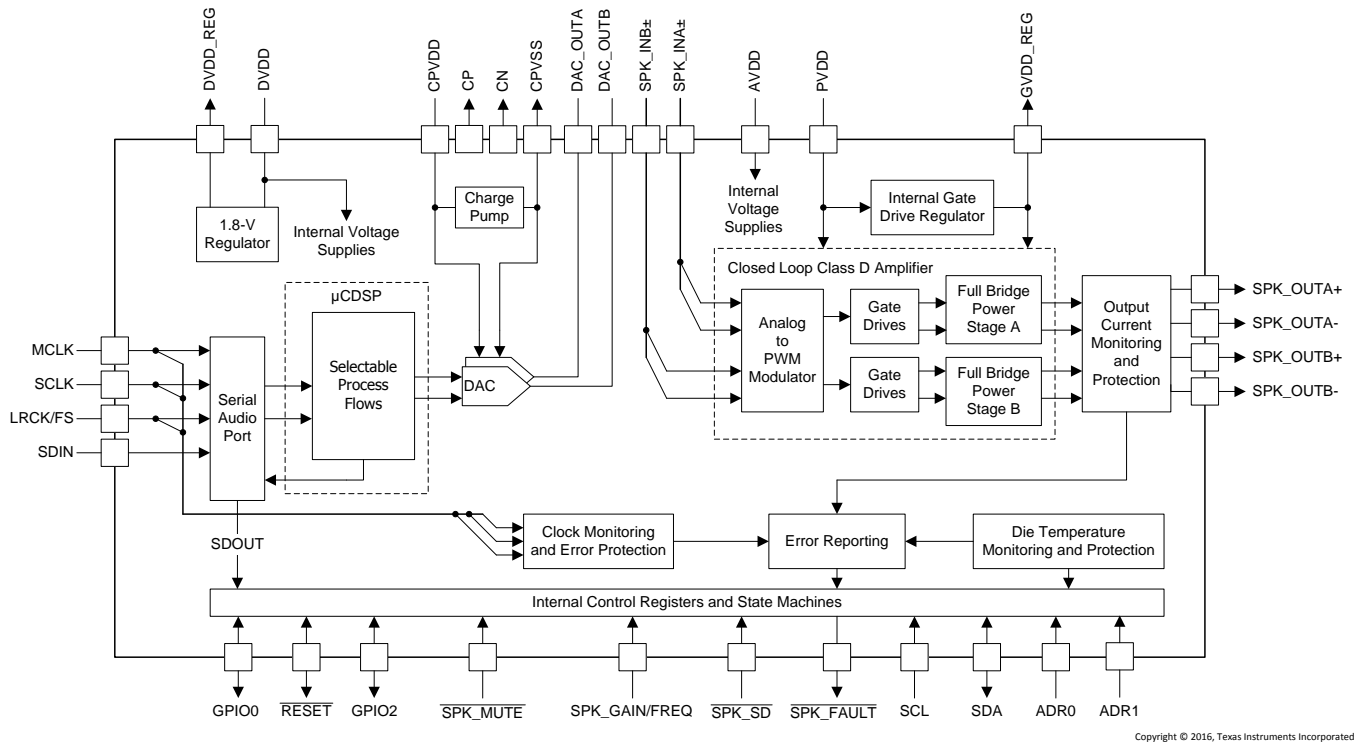

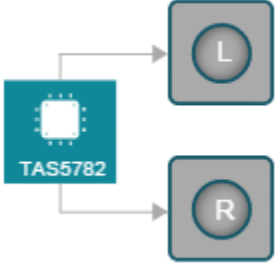
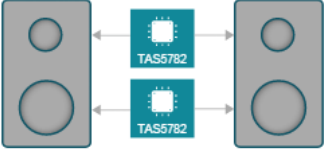
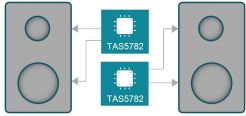
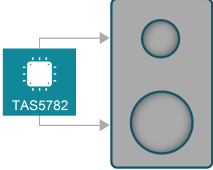
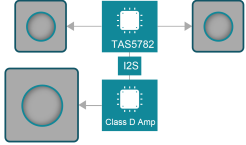

Figure 1. TAS5782M Functional Block Diagram

The μ CDSP processor is thought of as a 2-input and 2-output digital signal processor. The two input channels can come from a TDM stream, or a traditional I²S, left-justified or right-justified serial audio input stream and are presented to the μ CDSP through the serial audio port. The controls that configure the serial audio port to accept various input formats are detailed in the TAS5782M device data sheet (SLASEG8).

1.1 Supported Use Cases

The TAS5782M process flows have been generated based upon several popular configurations, primarily around the number and type of amplified outputs. [Table 1](#) shows the use cases supported by available process flows and PPC3 GUI.

Table 1. Supported Use Cases

| Mode | Also Known As | Amplifier Output Configuration | Symbol in PPC3 GUI |
|------|---------------------|---|---|
| 2.0 | Stereo | One device drives two full-range speakers in stereo. |  |
| 2.2 | Dual stereo | Two devices drive two-way speakers in stereo. One device drives two tweeters and one device drives two woofers. |  |
| 2.2 | Dual stereo | Two devices drive two-way speakers in stereo. One device drives the left speaker and one device drives the right speaker. |  |
| 1.1 | Bi-amped, dual mono | A single input signal is separated into high- and low-frequency content. One BTL output drives a high-frequency transducer and the other drives a low-frequency transducer. |  |
| 2.1 | N/A | One device uses 2.0 mode and a separate device uses mono mode. |  |
| Mono | 0.1 | A single signal, created from one or both of the two input signals sent via a single output created by placing the two output channels in parallel into a single channel, usually to drive more power |  |

2 Process Flows Cross Reference

Table 2 and Table 3 show the processing features of each process flow available in the current PPC3 GUI.

Table 2. Process Flows 1–4

| Feature | Process Flow 1 (96 kHz, 2.0 Standard Processing) | Process Flow 2 (96 kHz, 2.0 SmartAMP Processing) | Process Flow 3 (48 kHz, 2.0 Standard Processing) | Process Flow 4 (48 kHz, 2.0 SmartAMP Processing) |
|--|---|---|---|---|
| Maximum Internal Sample Rate | 96 kHz | 96 kHz | 48 kHz | 48 kHz |
| SRC (2× Decimator) and Auto-detect (96 kHz → 48 kHz or 88.2 kHz to 44.1 kHz) | x | x | √ | √ |
| Supported Input Sample Rates (16 kHz, 32 kHz, 44.1 kHz, 48 kHz, 88.2 kHz and 96 kHz) | √ | √ | √ | √ |
| Biquads for EQ Filtering (Individual Left and Right) | 12 | 12 | 15 | 15 |
| Input Mixer | √ | √ | √ | √ |
| Click and Pop Free Volume | √ | √ | √ | √ |
| Spatializer (Stereo Widening) | x | x | √ | √ |
| Dynamic Biquad | x | x | √ | √ |
| Bass Mono Mixer | x | x | √ | √ |
| 3-Band DRC (2 nd order) | √ | x | √ | x |
| AGL | √ | x | √ | x |
| Smart Excursion, Smart Thermal, and Smart Bass | x | √ | x | √ |
| Output Clipper | √ | √ | √ | √ |

Table 3. Process Flows 5–6

| Feature | Process Flow 5 (48 kHz, 2.1 Standard Processing) | Process Flow 6 (48kHz, 2.1 SmartAMP Processing) |
|---|---|--|
| Maximum Internal Sample Rate | 48 kHz | 48 kHz |
| Supported Input Sample Rates (16 kHz, 32 kHz, 44.1 kHz, and 48 kHz) | √ | √ |
| Biquads for EQ Filtering (Individual Left and Right) | 15 | 15 |
| Input Mixer | √ | √ |
| Click and Pop Free Volume | √ | √ |
| Spatializer (Stereo Widening) | √ | √ |
| Dynamic Biquad | √ | √ |
| Bass Mono Mixer | x | x |
| 3-Band DRC (2 nd order) | √ | x |
| Automatic Gain Limiter | √ | x |
| Smart Excursion, Smart Thermal and Smart Bass | x | √ |
| Output Clipper | √ | √ |

3 Process Flow 1 (96 kHz, 2.0 Standard Processing)

This process flow supports an internal sample rate of 96 kHz and is therefore considered “true” 96 kHz. It is intended for stereo speakers where the 3-band *Dynamic Range Control* (DRC) and AGL will have the same coefficients for left and right. It is possible to tune the left and right Biquads (BQs) in the 12-BQ bank individually between left and right.

Figure 2 depicts the signal path of this flow. The blocks in Figure 2 correspond to the functions found in the PPC3 GUI.

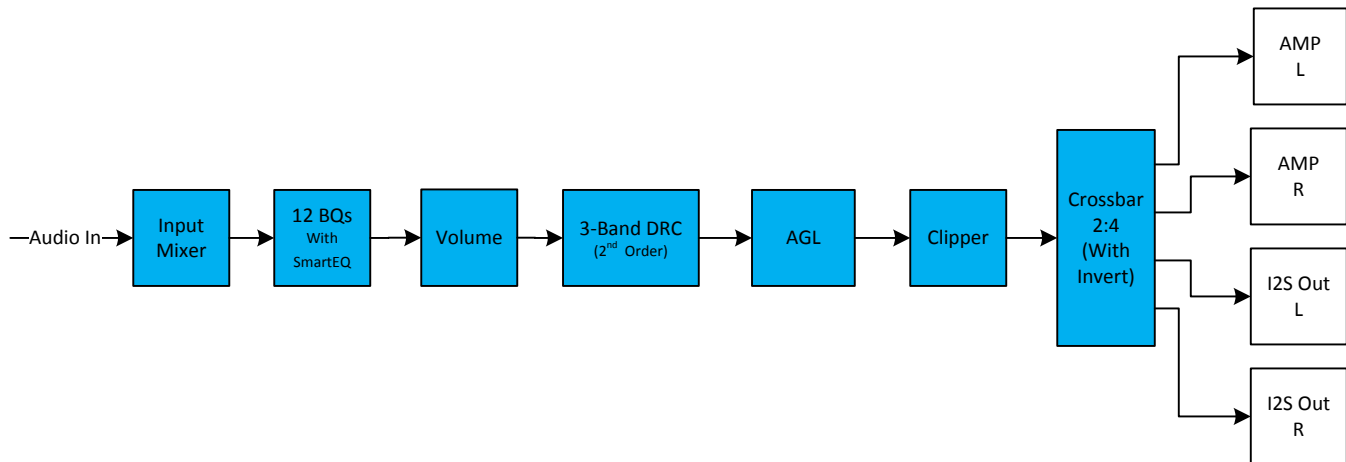

Figure 2. Process Flow 1

3.1 Input Mixer

The input mixer is used to mix the left and right channel input signals. Refer to [Section 9.1](#) for more details.

3.2 Equalizer

The equalizer contains 12 independent filters for both left and right channels. Refer to [Section 9.2](#) for more details.

3.3 Volume

This volume block is click and pop free. Refer to [Section 9.3](#) for more details.

3.4 3-Band DRC

The 3-Band DRC can be used to automatically control the audio signal amplitude or the dynamic range within specified limits. Refer to [Section 9.4](#) for more details.

3.5 AGL

The AGL can also be used to automatically control the audio signal amplitude or dynamic range within specified limits. Refer to [Section 9.5](#) for more details.

3.6 Clipper

A THD boost and fine volume together can be used for clipping. The THD boost block allows the user to programmatically increase the THD by clipping at an operating point earlier than that defined by the supply rails. Refer to [Section 9.11](#) for more details.

3.7 Output Crossbar

The crossbar provides the end user with a very flexible way to control what finally appears on amplifier outputs and I2S SDOOUT. Refer to [Section 9.12](#) for more details.

3.8 DSP Memory Map

Refer to [Section A.1](#) for the details.

4 Process Flow 2 (96 kHz, 2.0 SmartAmp Processing)

This process flow supports an internal sample rate of 96 kHz and is therefore considered “true” 96 kHz. This process flow is similar to process flow 1. The difference is the 3-Band DRC and AGL is removed to free up processing resources for these three components: *SmartBass* with *morphing*, *Excursion Limiter*, and *Thermal Limiter*.

Figure 3 depicts the signal path of this process flow. The blocks in Figure 3 correspond to the functions found in the PPC3 GUI.

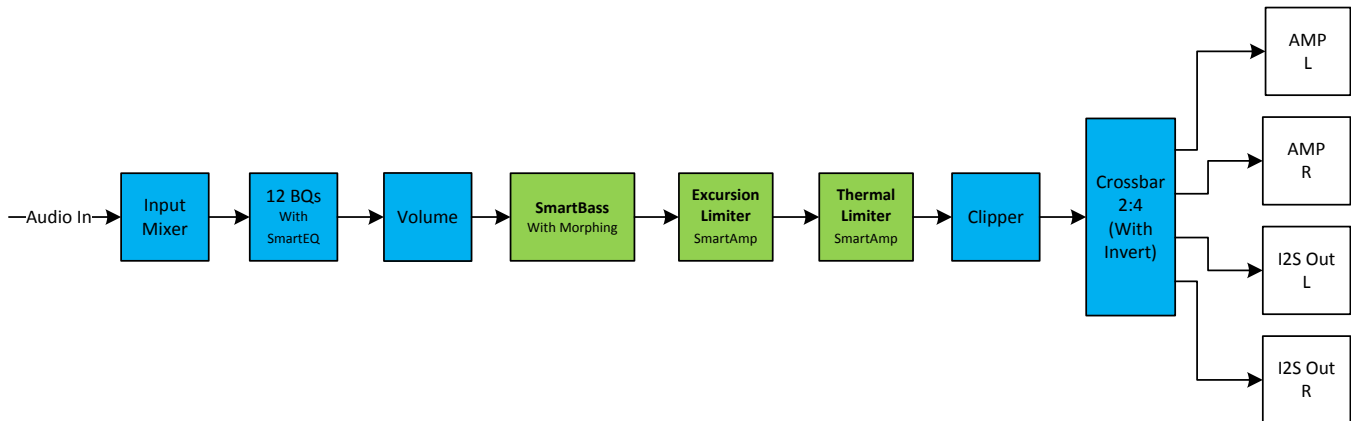

Figure 3. Process Flow 2

4.1 Input Mixer

The input mixer is used to mix the left and right channel input signals. Refer to [Section 9.1](#) for more details.

4.2 Equalizer

The equalizer contains 12 independent filters for both left and right channels. Refer to [Section 9.2](#) for more details.

4.3 Volume

This volume block is click and pop free. Refer to [Section 9.3](#) for more details.

4.4 Smart Bass, Excursion Limiter and Thermal Limiter

Smart Bass is an intelligent *True Bass Alignment* algorithm. *Smart Bass* uses the combination of the speaker model and a desired target response selected by the user to equalize the speaker in the bass region. This target response is critical for the sound character and the user can apply the same target response to very different speakers and get the same sound. Refer to [Section 10](#) to [Section 12](#) for more details.

Based on mechanical, electrical, and acoustical properties of speakers, *Excursion Limiter* and *Thermal Limiter* can predict potentially damaging situations, take timely precautions and therefore protect speakers from over-excursion and overheating.

4.5 Clipper

A THD boost and fine volume together can be used for clipping. The THD boost block allows the user to programmatically increase the THD by clipping at an operating point earlier than that defined by the supply rails. Refer to [Section 9.11](#) for more details.

4.6 Output Crossbar

The crossbar provides the end user with a very flexible way to control what finally appears on amplifier outputs and I2S SDOOUT. Refer to [Section 9.12](#) for more details.

4.7 DSP Memory Map

Refer to [Section A.2](#) for the details.

5 Process Flow 3 (48 kHz, 2.0 Standard Processing)

This process flow supports an internal sample rate of 48 kHz. It can accept both 48- and 96-kHz input sample rate but will down sample the 96 kHz to 48 kHz with a 2× decimator. Compared to the true 96-kHz process flow, this flow will have the same features but will on top of that also support: 2× decimator, 4th order DPEQ, and bass mono mixer.

Figure 4 depicts the signal path of this process flow. The blocks in Figure 4 correspond to the functions found in the PPC3 GUI.

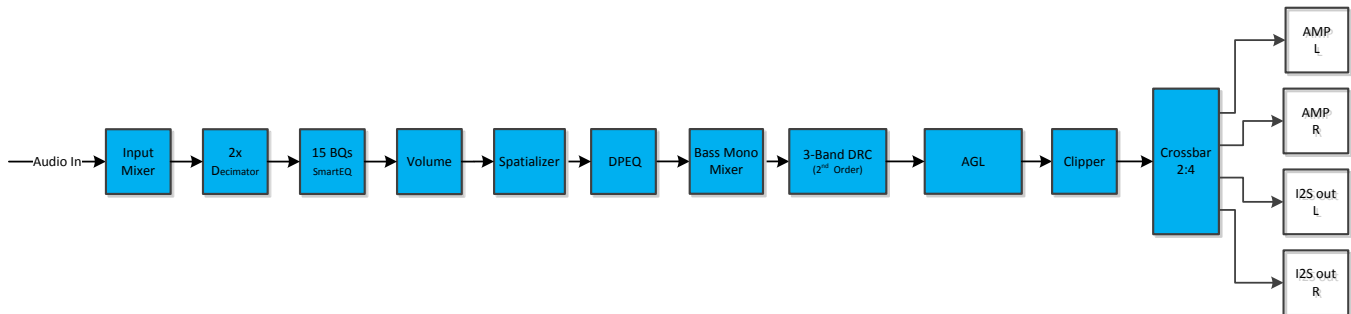

Figure 4. Process Flow 3

5.1 Input Mixer

The input mixer is used to mix the left and right channel input signals. Refer to Section 9.1 for more details.

5.2 Decimator

A decimator is added in order to support the “pseudo 96 kHz” mode. The device will accept 96-kHz sample rate and internally decimate it to 48 kHz for further processing.

5.3 Equalizer

The equalizer contains 15 independent filters for both left and right channels. Refer to Section 9.2 for more details.

5.4 Volume

This volume block is click and pop free. Refer to Section 9.3 for more details.

5.5 Spatializer

Spatializer is a method to increase the field of sound for a broader and more encompassing audio experience. Refer to Section 9.4 for more details.

5.6 DPEQ

The dynamic parametric equalizer is used to mix the audio signals through two signal paths (low level and high level). These two paths are used with separate equalization properties. A third path monitors the incoming audio and determines the thresholds and mixing characteristics between these two paths. Thus, the mix between the two high- and low-level DBE channels is dynamic in nature and depends on the incoming audio. Refer to Section 9.5 for more details.

5.7 Bass Mono Mixer

The bass mono mixer is used to mix left and right channels, effectively creating a mono signal below a configurable frequency on both channels. Refer to Section 9.6 for more details.

5.8 3-Band DRC

The 3-Band DRC can be used to automatically control the audio signal amplitude or the dynamic range within specified limits. Refer to [Section 9.7](#) for more details.

5.9 AGL

The AGL can also be used to automatically control the audio signal amplitude or dynamic range within specified limits. Refer to [Section 9.8](#) for more details.

5.10 Clipper

A THD boost and fine volume together can be used for clipping. The THD boost block allows the user to programmatically increase the THD by clipping at an operating point earlier than that defined by the supply rails. Refer to [Section 9.11](#) for more details.

5.11 Output Crossbar

The crossbar provides the end user with a very flexible way to control what finally appears on amplifier outputs and I2S SDOUT. Refer to [Section 9.12](#) for more details.

5.12 DSP Memory Map

Refer to [Section A.3](#) for the details.

6 Process Flow 4 (48 kHz, 2.0 SmartAmp Processing)

This process flow supports an internal sample rate of 48 kHz. It can accept both 48- and 96-kHz input sample rate but will down sample the 96 kHz to 48 kHz with a 2x decimator.

The process flow is similar to Process Flow 3. The difference is the 3-Band DRC and AGL is removed to free up processing resources for these three components: *SmartBass with morphing*, *Excursion Limiter*, and *Thermal Limiter*.

Figure 5 depicts the signal path of this flow. The blocks in Figure 5 correspond to the functions found in the PPC3 GUI.

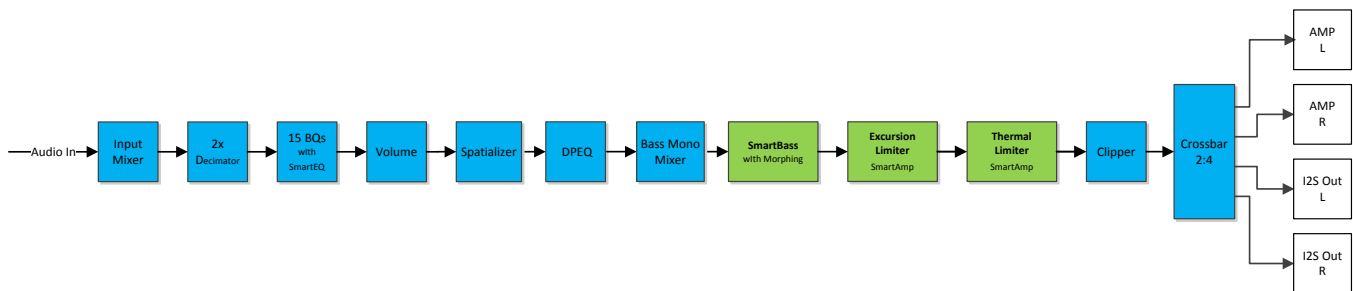

Figure 5. Process Flow 4

6.1 Input Mixer

The input mixer is used to mix the left and right channel input signals. Refer to [Section 9.1](#) for more details.

6.2 Decimator

A decimator is added in order to support the “pseudo 96 kHz” mode. The device will accept 96-kHz sample rate and internally decimate it to 48 kHz for further processing.

6.3 Equalizer

The equalizer contains 15 independent filters for both left and right channels. Refer to [Section 9.2](#) for more details.

6.4 Volume

This volume block is click and pop free. Refer to [Section 9.3](#) for more details.

6.5 Spatializer

Spatializer is a method to increase the field of sound for a broader and more encompassing audio experience. Refer to [Section 9.4](#) for more details.

6.6 DPEQ

The dynamic parametric equalizer is used to mix the audio signals through two signal paths (low level and high level). These two paths are used with separate equalization properties. A third path monitors the incoming audio and determines the thresholds and mixing characteristics between these two paths. Thus, the mix between the two high- and low-level DBE channels is dynamic in nature and depends on the incoming audio. Refer to [Section 9.5](#) for more details.

6.7 Bass Mono Mixer

The bass mono mixer is used to mix left and right channels, effectively creating a mono signal below a configurable frequency on both channels. Refer to [Section 9.6](#) for more details.

6.8 **Smart Bass, Excursion Limiter and Thermal Limiter**

Smart Bass is an intelligent *True Bass Alignment* algorithm. *Smart Bass* uses the combination of the speaker model and a desired target response selected by the user to equalize the speaker in the bass region. This target response is critical for the sound character and the user can apply the same target response to very different speakers and get the same sound. Refer to [Section 10](#) to [Section 12](#) for more details.

Based on mechanical, electrical, and acoustical properties of speakers, *Excursion Limiter* and *Thermal Limiter* can predict potentially damaging situations, take timely precautions and therefore protect speakers from over-excursion and overheating.

6.9 **Clipper**

A THD boost and fine volume together can be used for clipping. The THD boost block allows the user to programmatically increase the THD by clipping at an operating point earlier than that defined by the supply rails. Refer to [Section 9.11](#) for more details.

6.10 **Output Crossbar**

The crossbar provides the end user with a very flexible way to control what finally appears on amplifier outputs and I²S SDOOUT. Refer to [Section 9.12](#) for more details.

6.11 **DSP Memory Map**

Refer to [Section A.4](#) for the details.

7 Process Flow 5 (48 kHz, 2.1 Standard Processing)

This process flow supports an internal sample rate of 48 kHz. This supports 2.1 and 1.1 speaker configurations and therefore supports components for a digital crossover. The 15 BQs can be tuned individually between left and right, but all other components in the stereo path will have the same tuning coefficients for left and right.

Figure 6 depicts the signal path of this flow. The blocks in Figure 6 correspond to the functions found in the PPC3 GUI.

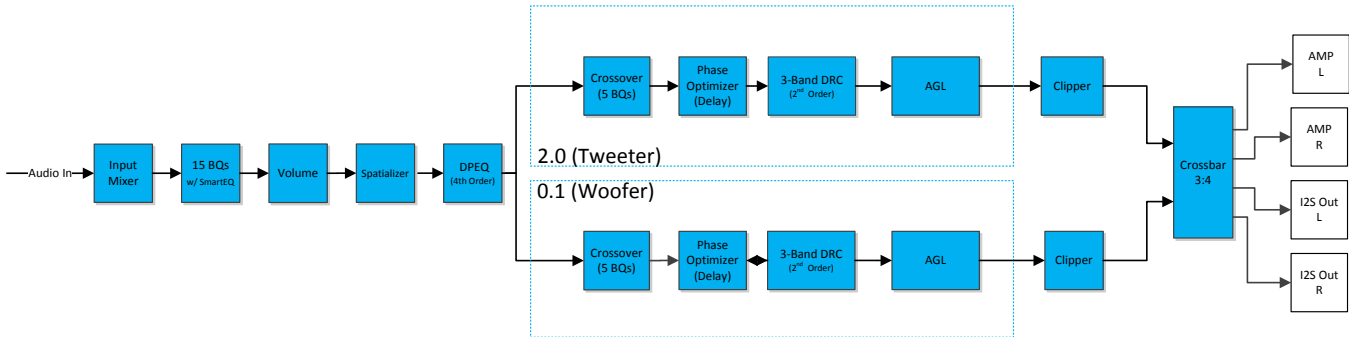

Figure 6. Process Flow 5

7.1 Input Mixer

The input mixer is used to mix the left and right channel input signals. Refer to [Section 9.1](#) for more details.

7.2 Equalizer

The equalizer contains 15 independent filters for both left and right channels. Refer to [Section 9.2](#) for more details.

7.3 Volume

This volume block is click and pop free. Refer to [Section 9.3](#) for more details.

7.4 Spatializer

Spatializer is a method to increase the field of sound for a broader and more encompassing audio experience. Refer to [Section 9.4](#) for more details.

7.5 DPEQ

The dynamic parametric equalizer is used to mix the audio signals through two signal paths (low level and high level). These two paths are used with separate equalization properties. A third path monitors the incoming audio and determines the thresholds and mixing characteristics between these two paths. Thus, the mix between the two high- and low-level channels is dynamic in nature and depends on the incoming audio. Refer to [Section 9.5](#) for more details.

7.6 Crossover

The crossover block is used to set low pass filters on the woofer and high pass filters on the tweeter. Refer to [Section 9.9](#) for more details.

7.7 Phase Optimizer

The phase optimizer allows time aligning the 2.0 (tweeter) path with the 0.1 (woofer) path. Refer to [Section 9.10](#) for more details.

7.8 3-Band DRC

The 3-Band DRC can be used to automatically control the audio signal amplitude or the dynamic range within specified limits. Refer to [Section 9.7](#) for more details.

7.9 AGL

The AGL can also be used to automatically control the audio signal amplitude or dynamic range within specified limits. Refer to [Section 9.8](#) for more details.

7.10 Clipper

The clipper allows the user to programmatically increase the THD by clipping at an operating point earlier than that defined by the supply rails. Refer to [Section 9.11](#) for more details.

7.11 Output Crossbar

The crossbar provides the end user with a very flexible way to control what finally appears on amplifier outputs and I2S SDOUT. Refer to [Section 9.12](#) for more details.

7.12 DSP Memory Map

Refer to [Section A.5](#) for details.

8 Process Flow 6 (48 kHz, 2.1 SmartAmp Processing)

The process flow is similar to [Process Flow 5](#). The difference is the 3-Band DRC and AGL is removed to free up processing resources for these three components: *SmartBass with morphing*, *Excursion Limiter* and *Thermal Limiter*.

[Figure 7](#) depicts the signal path of this flow. The blocks in [Figure 6](#) correspond to the functions found in the PPC3 GUI.

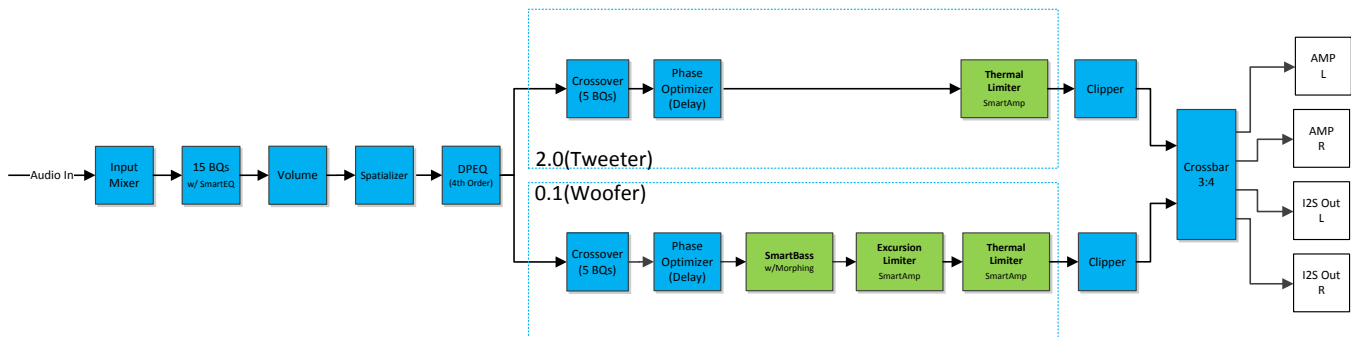

Figure 7. Process Flow 5

8.1 Input Mixer

The input mixer is used to mix the left and right channel input signals. Refer to [Section 9.1](#) for more details.

8.2 Equalizer

The equalizer contains 15 independent filters for both left and right channels. Refer to [Section 9.2](#) for more details.

8.3 Volume

This volume block is click and pop free. Refer to [Section 9.3](#) for more details.

8.4 Spatializer

Spatializer is a method to increase the field of sound for a broader and more encompassing audio experience. Refer to [Section 9.4](#) for more details.

8.5 DPEQ

The dynamic parametric equalizer is used to mix the audio signals through two signal paths (low level and high level). These two paths are used with separate equalization properties. A third path monitors the incoming audio and determines the thresholds and mixing characteristics between these two paths. Thus, the mix between the two high- and low-level channels is dynamic in nature and depends on the incoming audio. Refer to [Section 9.5](#) for more details.

8.6 Crossover

The crossover block is used to set low pass filters on the woofer and high pass filters on the tweeter. Refer to [Section 9.9](#) for more details.

8.7 Phase Optimizer

The phase optimizer allows time aligning the 2.0 (tweeter) path with the 0.1 (woofer) path. Refer to [Section 9.9](#) for more details.

8.8 Smart Bass, Excursion Limiter and Thermal Limiter

Smart Bass is an intelligent True Bass Alignment algorithm. Smart Bass uses the combination of the speaker model and a desired target response selected by the user to equalize the speaker in the bass region. This target response is critical for the sound character and the user can apply the same target response to very different speakers and get the same sound. Refer to Section 10 to 12 for more details.

8.9 Clipper

The clipper allows the user to programmatically increase the THD by clipping at an operating point earlier than that defined by the supply rails. Refer to [Section 9.11](#) for more details.

8.10 Output Crossbar

The crossbar provides the end user with a very flexible way to control what finally appears on amplifier outputs and I2S SDOOUT. Refer to [Section 9.12](#) for more details.

8.11 DSP Memory Map

Refer to [Section A.6](#) for details.

9 Audio Processing Blocks

9.1 Input Mixer

The input mixer can be used to mix the left and right channel input signals as shown in [Figure 8](#). The input mixer has four coefficients, which control the mixing and gains of the input signals.

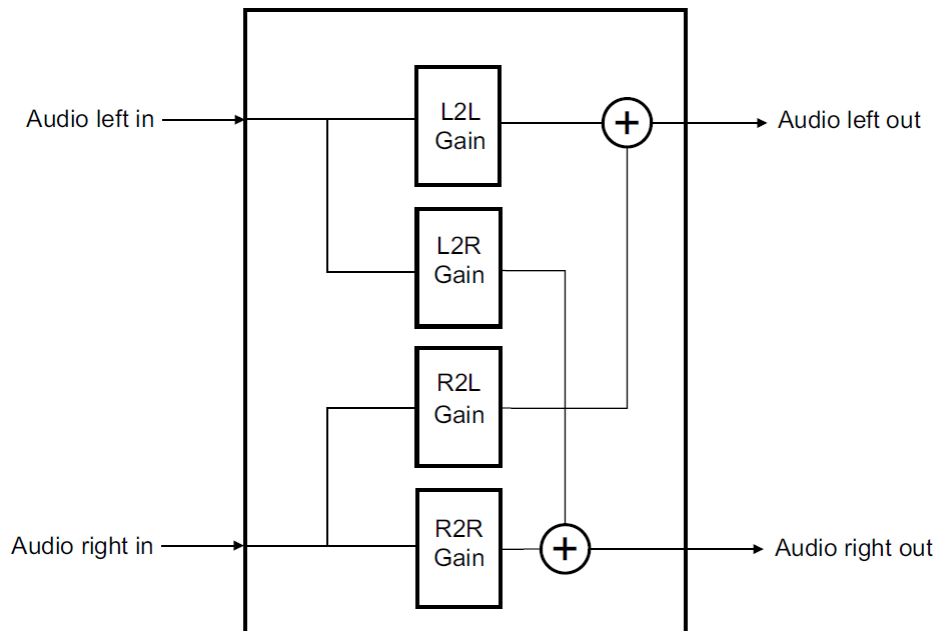

Figure 8. Input Mixer

The *Basic* tab (see [Figure 9](#)) provides the easiest way for configuration in PPC3 GUI.

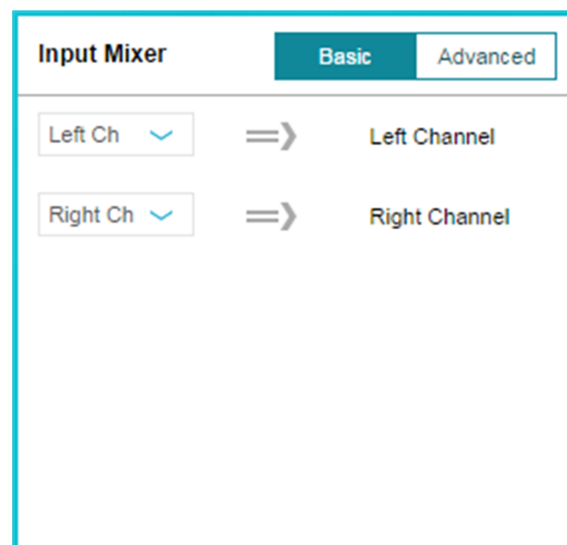

Figure 9. Input Mixer (Basic Tab)

Switch to the *Advanced* tab (see Figure 10) if all the four coefficients need to be adjusted. Note that the four parameters need to be specified in decibels (dB). The *Invert* options will reverse the sign of the gain values.

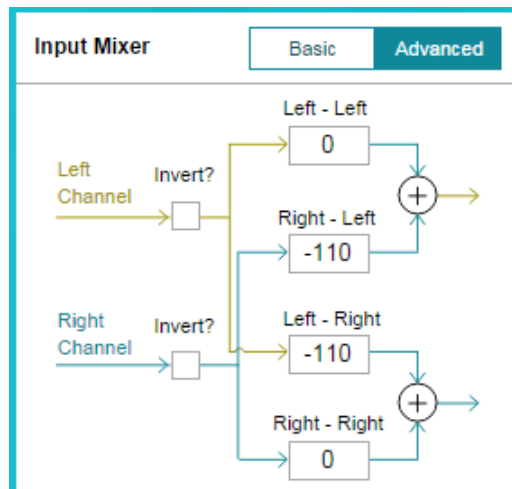

Figure 10. Input Mixer (Advanced Tab)

9.2 Equalizer

The equalizers are implemented using cascaded “direct form 1” BQs structures as shown in Figure 11.

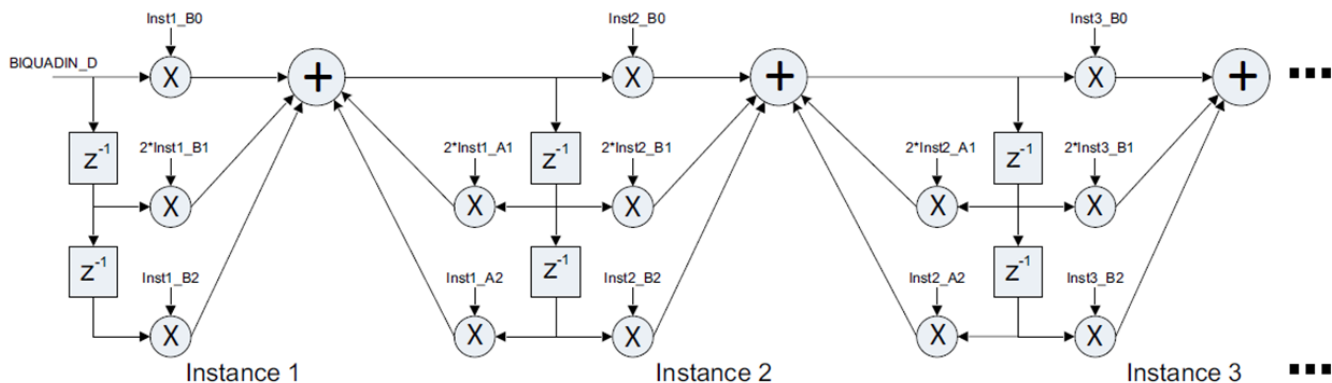

Figure 11. Cascaded BQ Structure

$$H(z) = \frac{b_0 + b_1z^{-1} + b_2z^{-2}}{a_0 + a_1z^{-1} + a_2z^{-2}} \tag{1}$$

All BQ coefficients are normalized with a0 to ensure that a0 is equal to 1. The structure requires 5 BQ coefficients as shown in Table 4. Any BQ with coefficients greater than 1 undergoes gain scaling.

Table 4. BQ Coefficients Normalization

| BQ Coefficient | Coefficient Calculation |
|----------------|-------------------------|
| A0_DSP | b0 / a0 |
| A1_DSP | b1 / (a0 x 2) |
| A2_DSP | b2 / a0 |
| B1_DSP | -a1 / (a0 x 2) |
| B2_DSP | -a2 / a0 |

Depending on the process flow selected, the *Equalizer Tuning* window may contain 12 or 15 independent filters for both left and right channels. They are designed for tuning the frequency response of the overall system. This is where the bulk of the frequency compensation occurs. Complex tuning shapes can be made to compensate for deficiencies in speaker response.

As [Figure 12](#) shows, each filter has quite a few different filter types and can be turned on or off independently. All the changes to these filters are reflected in [Figure 12](#). The composite plot (red) shows the overall frequency response alteration applied to the incoming digital audio data. *Phase*, *Group Delay*, *Impulse Response* and *Pole zero* charts are also available on the right side.



Figure 12. Equalizer Tuning Window

The equalizers for left and right channels are *ganged* by default, but they can be configured independently by deselecting the *Gang* option. **For the first two 96-kHz process flows, the *Gang* option is handled by the GUI but for the two other flows, this is done with a multiplexer, which saves half of the writes in gang mode.**

9.3 Volume

Figure 13 shows the default volume in PPC3 GUI. Note that volume needs to be specified in decibels (dB). Independent volume change for the left and right channels is achieved by deselecting the *Gang* option.



Figure 13. Volume

The volume block is implemented using an alpha filter structure. As Figure 14 shows, when a volume level change is initiated, the volume block will assure a smooth transition to the newly commanded volume level without producing artifacts such as pops and clicks.

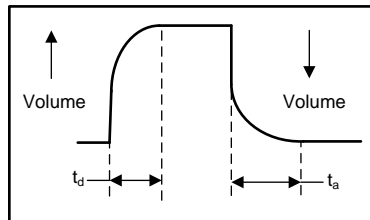

Figure 14. Volume Attack and Decay

9.4 Spatializer

Spatializer is a method to increase the field of sound for a broader and more encompassing audio experience. Here, copies of the left and right channels are subtracted from each other. This creates a signal that removes any audio or instrumentation that is shared by both channels. Next a bandpass filter sets the frequency range for which the effect is active. After which, a level control adjusts the strength of this channel before being reintroduced back into the original left and right channels.

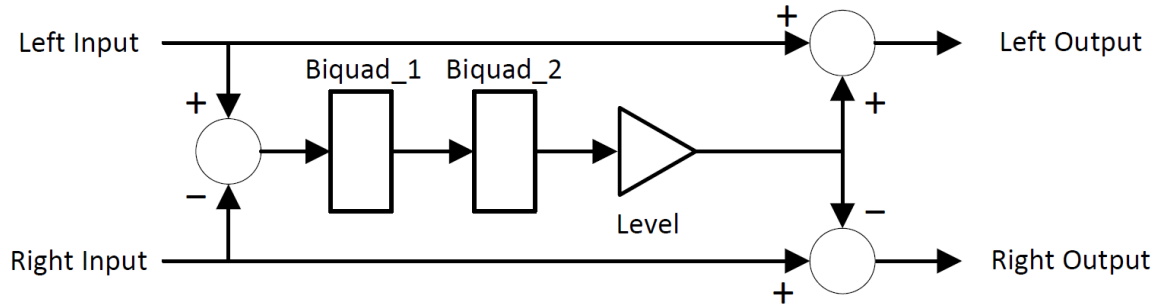

Figure 15. Spatializer Block Diagram

It is generally not recommend extending the bandpass filter below 300 Hz, since low-frequency content often presents itself in both channels. Extending the bandpass too low results in a loss of bass response. Similarly, extending the bandpass too high can create effects similar to reverb which can blur the spatial cues of music.

In the *Spatializer Tuning* window (see Figure 16), the pass band can be set as well as the *Level* which controls the level of the effect.

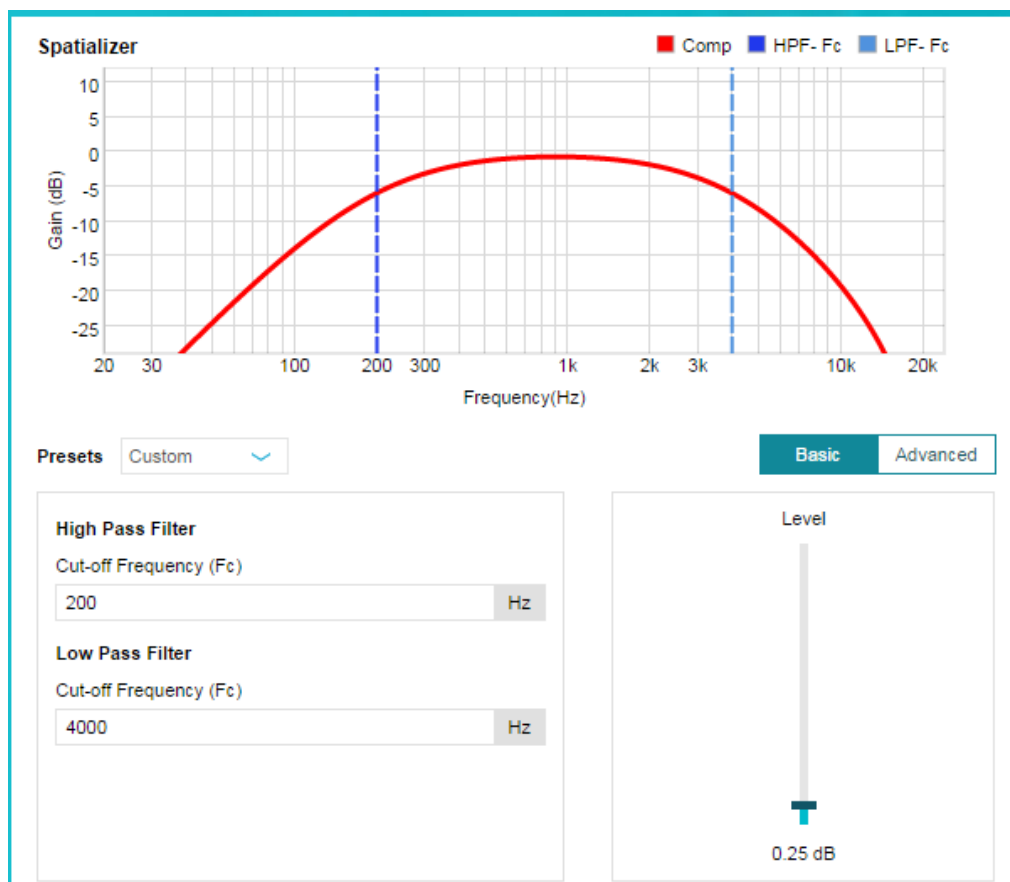

Figure 16. Spatializer Tuning Window

For a given piece of end equipment, it may be helpful to create three *presets* from which to choose. This provides the option of choosing the preferred type of spatializing effect. The three settings can vary both the HPF, LPF, and effect intensity and their settings stored in the system processor to be updated upon a button press from the end user.

Three recommended *presets* are available in the GUI:

Table 5. Recommended Presets Available in the GUI

| Preset | Frequency Range | Level | Comment |
|--------|------------------|-------|---|
| Full | 300 Hz to 20 kHz | 0.75 | Reverberant sounding |
| Medium | 800 Hz to 6 kHz | 0.5 | |
| Low | 4 kHz to 20 kHz | 0.25 | Works well in systems with a flat frequency response up to 16-18 kHz. |

9.5 DPEQ

The dynamic parametric equalizer mixes the audio signals routed through two paths containing two Biquads each based upon the signal level detected by the sense path, as shown in [Figure 17](#).

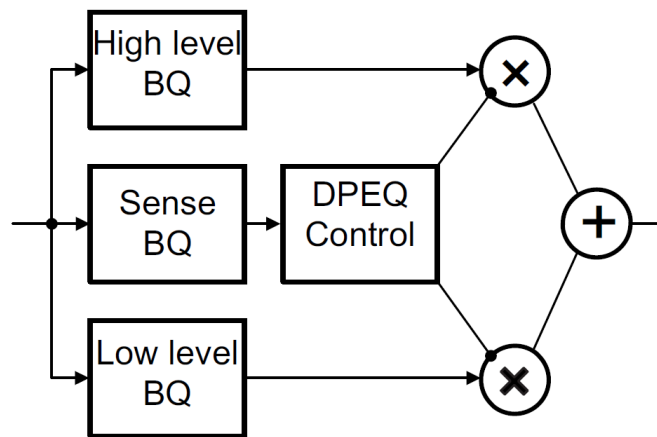

Figure 17. DPEQ

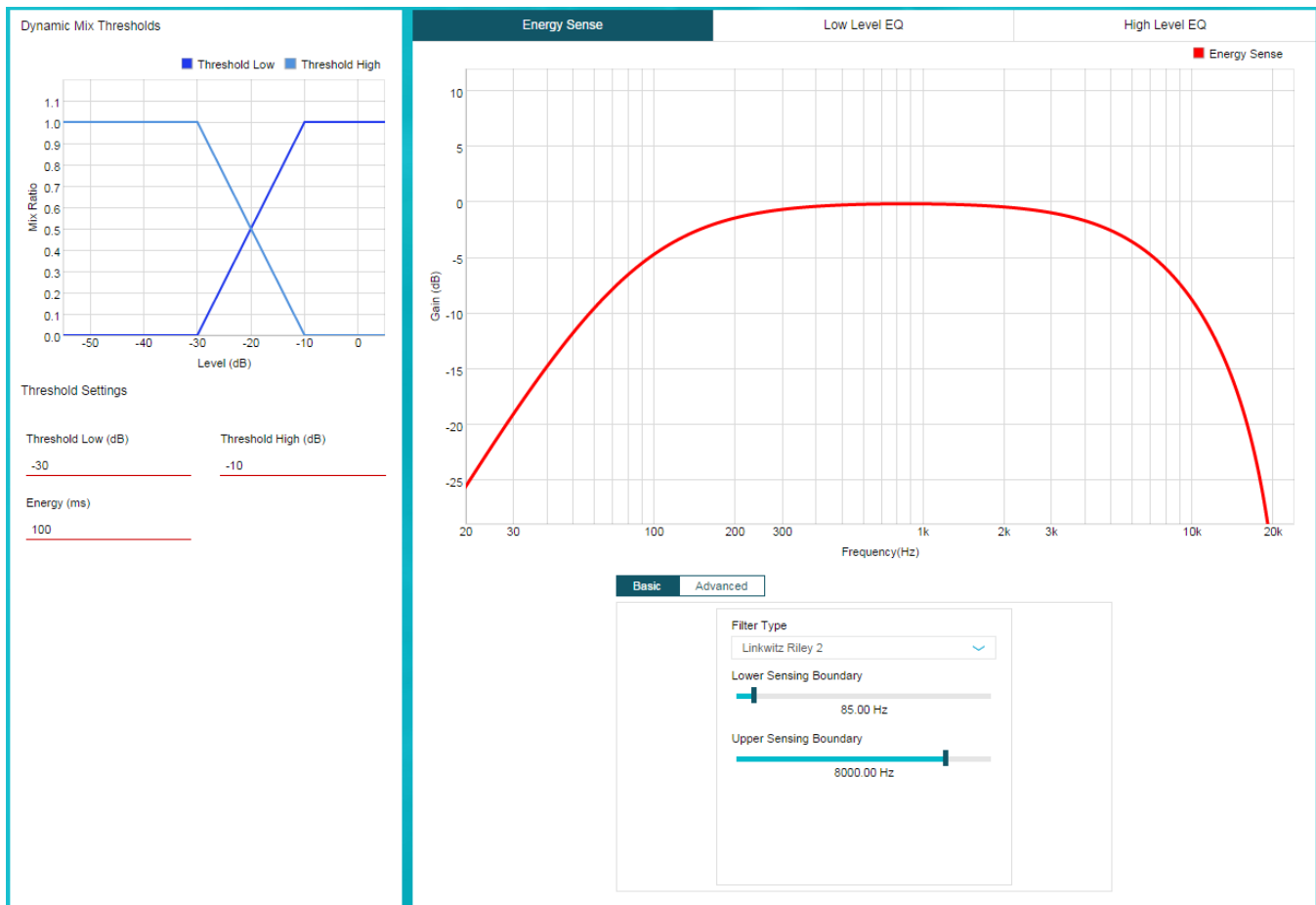

Figure 18. DPEQ Tuning Window

Dynamic Mix Thresholds

The Energy(ms) simply tells the algorithm for how long to average the samples of audio before it determines how it compares to the mixing thresholds. The shorter the time, the faster the mixer reacts to changes in the input signal level. The longer the time, the slower the mixer reacts to changes in level.

The mixing of the two paths (low level and high level) is controlled by setting the *Threshold Low (dB)* and *Threshold High (dB)*. When the averaged signal (as set by the *Energy*) is below the *Threshold Low*, the dynamic mixer sends all of the audio through the low-level path. When the signal is above the *Threshold High*, it is sent through the upper-level path. When the signal is between the two, it is mixed together by the dynamic mixer level.

Energy Sense

The sense path contains 2 configurable Biquads, which can be used to focus the DEQ sensing on a specific frequency bandwidth.

Low Level EQ

The low-level path also has 2 configurable Biquads to establish the EQ curve which the audio is sent through when the time average signal is at a low-level. This fully-functional Biquad can be assigned to several filter types. This determines frequency response when low-level is active based on the *Energy* configuration and the mixing thresholds.

High Level EQ

The high-level path, similar to the low-level path, has 2 Biquads that can set the EQ curve used when the time averaged input signal is above the upper mixing threshold.

9.6 Bass Mono Mixer

Mono Bass Frequency is the cross over point below which the left and right channels are mixed, effectively creating a mono signal below that frequency on both channels. In systems with a common cabinet for left and right drivers this control ensures against the possibility of a drop in the bass level due to phase mismatch between the left and right channel signals. For passive radiator systems with 2 active speakers and 1 passive, the bass mono mixer must be used if a *SmartAmp* processing is selected.

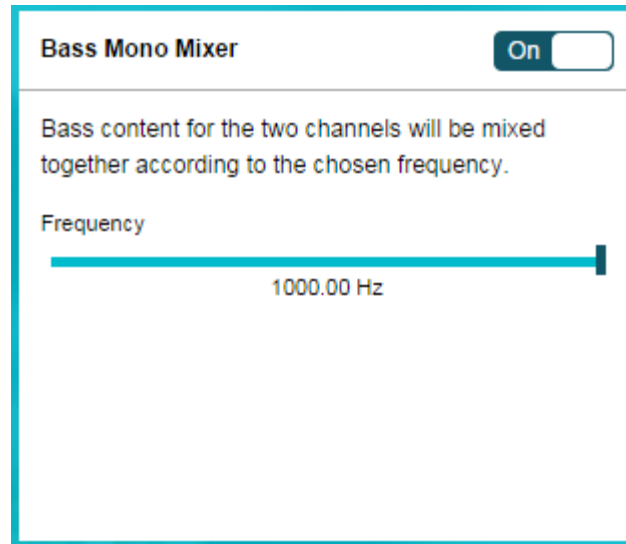

Figure 19. Bass Mono Mixer

9.7 3-Band DRC

The Dynamic Range Control (DRC) is a feed-forward mechanism that can be used to automatically control the audio signal amplitude or the dynamic range within specified limits. The dynamic range control is done by sensing the audio signal level using an estimate of the alpha filter energy then adjusting the gain based on the region and slope parameters that are defined. The 3-Band DRC is shown in Figure 20.

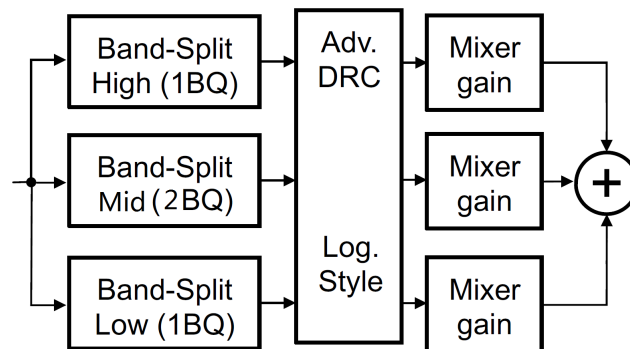

Figure 20. 3-Band DRC

The 3-band DRC is comprised of three DRCs that can be split into three bands using the BQ at the input of each band. The DRC in each band is equipped with individual energy, attack, and decay time constants. The DRC time constants control the transition time of changes and decisions in the DRC gain during compression or expansion. The energy, attack, and decay time constants affect the sensitivity level of the DRC. The shorter the time constant, the more aggressive the DRC response, and vice versa.

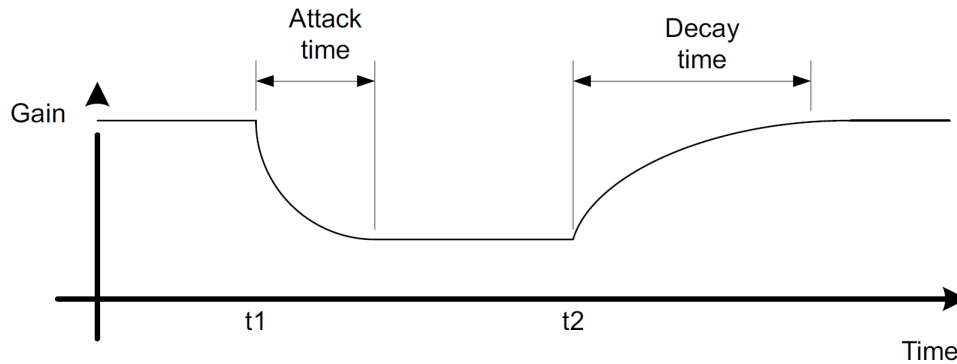

Figure 21. DRC Attack and Decay

This DRC can be used for power limiting and signal compression; therefore, it must be tested with maximum signal levels for the desired application. Use a resistive load for initial testing. However, the speaker used in the end application must be used for final testing and tweaking.



Figure 22. DRC Tuning Window

The *DRC Tuning* window consists of three identical windows for low, mid, and high bands. Each has a DRC curve that offers 3 regions of compression. The points on the DRC curve can be dragged and dropped.

Below each DRC plot, parameters such as threshold, offset, and ratio can be manually typed in for each of the 3 regions. By typing a value and pressing *Enter* on the keyboard, the DRC curve automatically adjusts to the entered parameter.

DRC Time Constant

Change time constants by entering new values for each band.

Attack(ms) determines the attack time of the DRC and *Decay(ms)* determines the release time once the windowed energy band passes. *Energy(ms)* controls the time averaging windowing uses to determine the average signal energy; therefore, where the incoming signal compares to the set DRC curve. It is beneficial to have control over the DRC time constant for a given frequency band to avoid beating tones caused by the DRC attack and the incoming signal frequency.

The mixer gain controls the relative gain of each of the 3 frequency bands after the DRCs when they are mixed together. This is used to attenuate one of the frequency bands relative to the others, if needed.

Make note of the sign of the gain coefficients. Since filters affect phase, a phase reversal or a 180 degree phase shift may be necessary. Use a negative sign on the coefficient to reverse the phase for the second-order LR filter.

Crossover

Configure the frequency range associated with each of the 3 bands used, where the tuning can take place. After tuning, the response is automatically displayed on the right side of the DRC plot. The Crossover configuration has two tabs. In the *Basic* tab, only the filter type and cut-off frequencies need to be determined. Go to the *Advanced* tab if more parameters need to be adjusted.

9.8 AGL

The *Automatic Gain Limiter (AGL)* is a feedback mechanism that can be used to automatically control the audio signal amplitude or dynamic range within specified limits. The automatic gain limiting is done by sensing the audio signal level using an alpha filter energy structure at the output of the AGL then adjusting the gain based on whether the signal level is above or below the defined threshold. Three decisions made by the AGL are engage, disengage, or do nothing. The rate at which the AGL engages or disengages depends on the attack and release settings respectively.

Figure 23 shows the *AGL Tuning* window. By default, the AGL is disabled and it can be enabled by clicking the ON/OFF switch on the top right corner.

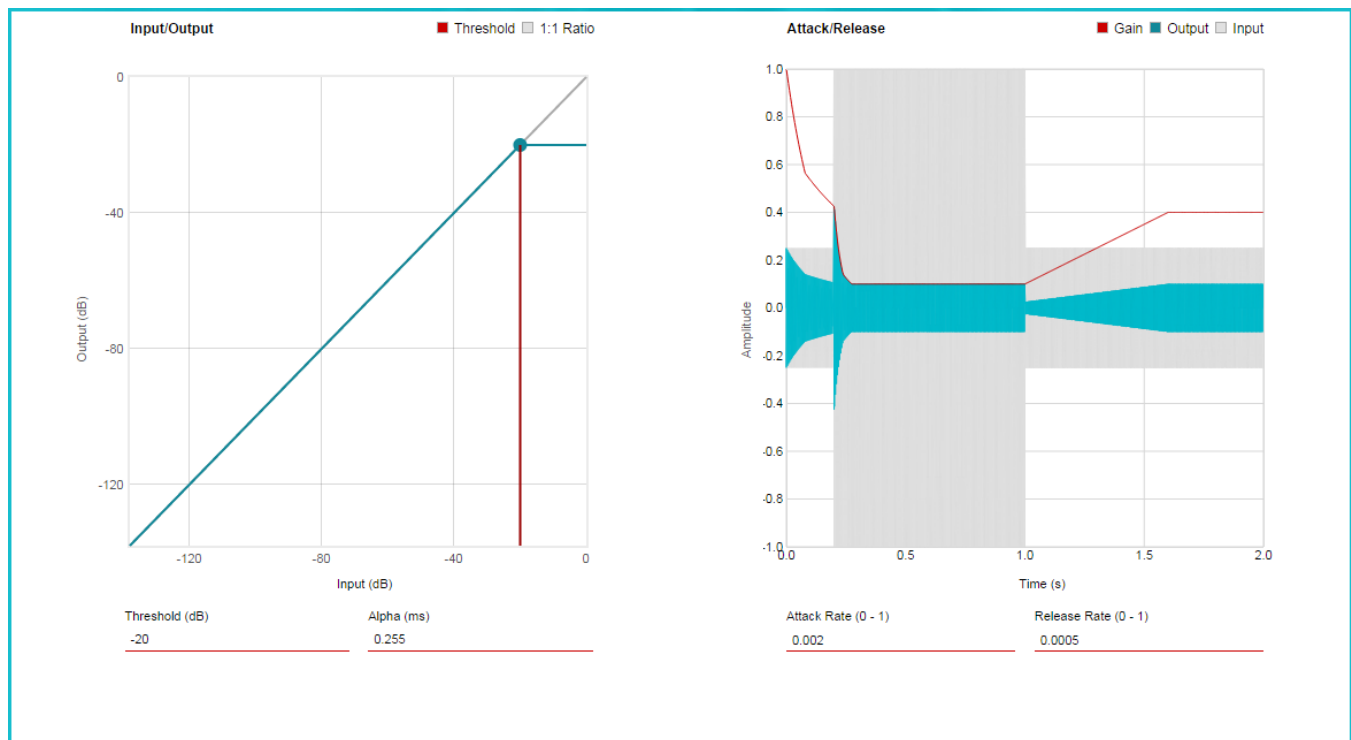

Figure 23. AGL Tuning Window

Threshold (dB)

This parameter sets the threshold at which the compressor will be activated. Lowering the threshold will cause the compression to be activated at lower volume levels. Once the signal exceeds this threshold, compression will be applied.

Alpha(ms)

This parameter configures the sharpness of the compression knee of the AGL.

Attack Rate (0–1)

This parameter controls how quickly compression will be applied to the signal. Higher values will cause the compressor to respond to signals quickly, while lower values will decrease the response time.

Release Rate (0 – 1)

This parameter controls how quickly compression will be removed from the signal as the signal gets quieter. Higher values will cause the compressor to release from signals quickly, while lower values will decrease the release time.

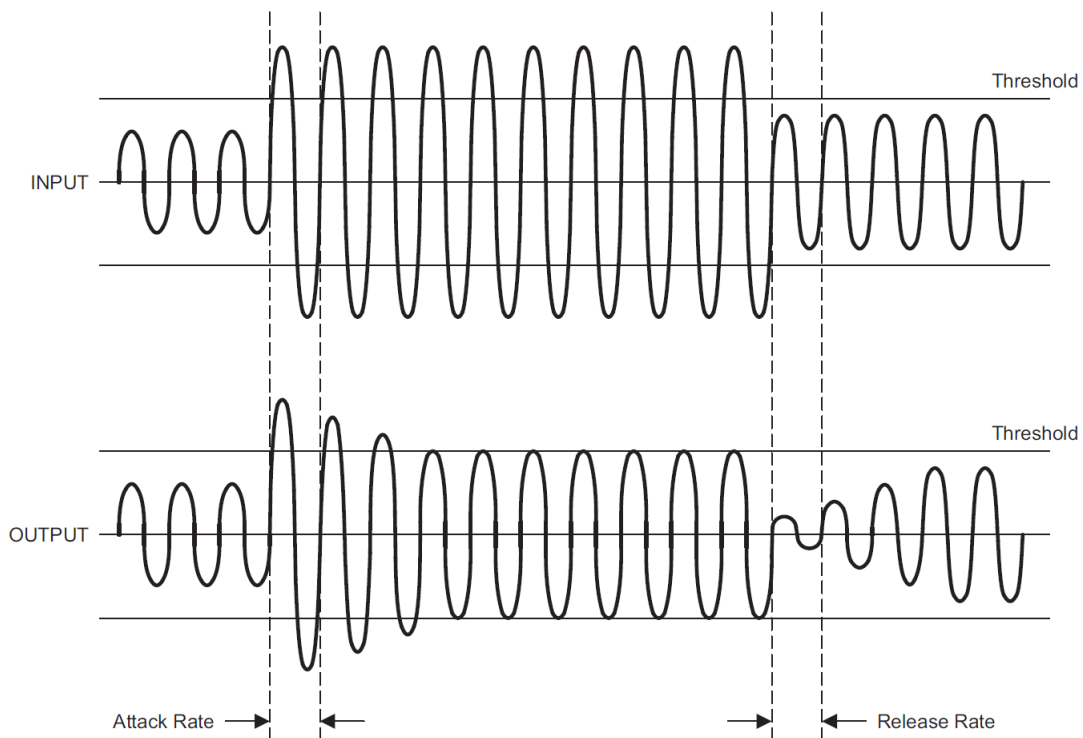

Figure 24. AGL Attack and Release

9.9 Crossover

The major purpose of a digital crossover is to split the frequencies and then send them off to each individual speaker. The crossover is actually a series of filters, which filter out the frequencies that should not go to each speaker. Usually, low pass filters are set on the woofer and high pass filters are set on the tweeter in the crossover.

The plot in [Figure 25](#) in the *Crossover Window* shows the response of the woofer and tweeter with crossover filters in place, and the combined response after crossover tuning. Five BQs are available for woofer and tweeter channel. Fine-tune the filters to get the smoothest response around the crossover frequency. Optimally, the crossover sum curve (dark green) is flat and crossover difference curve (light green) has a large dip. If the opposite is seen, it is necessary to invert the phase of BQ1 for the woofer or tweeter.

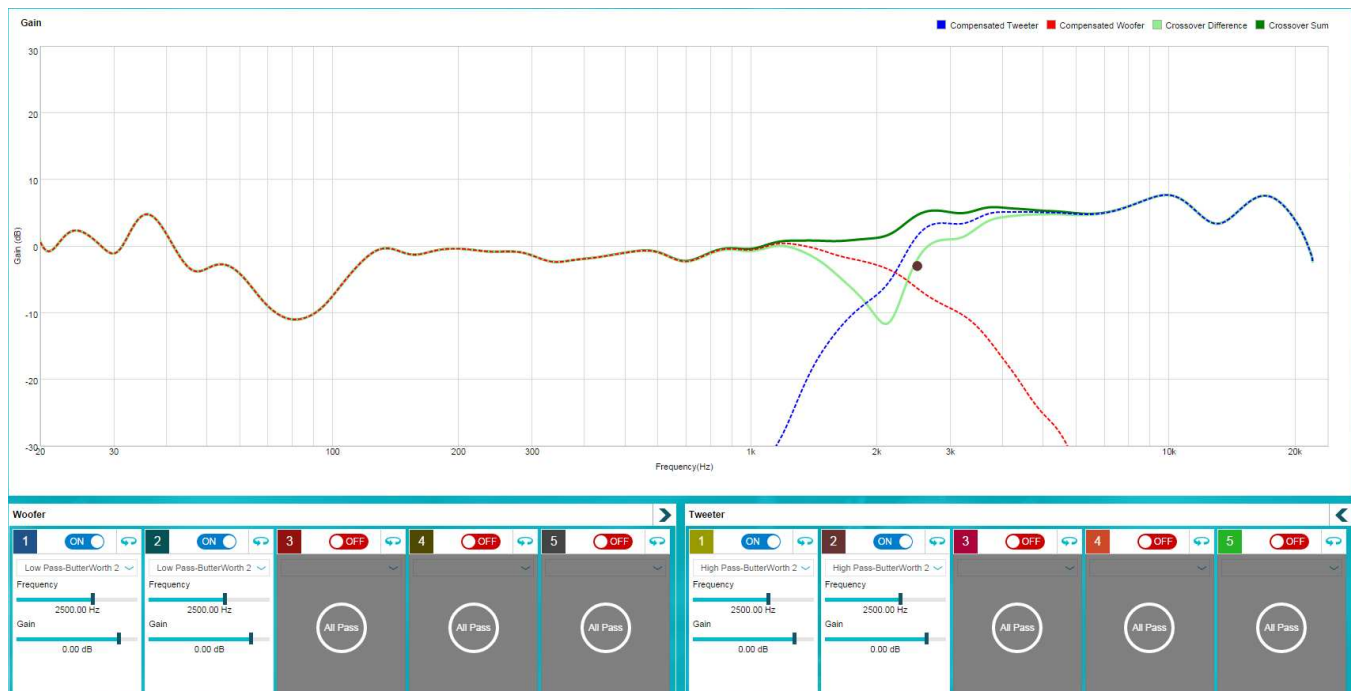



Figure 25. Crossover Tuning Window

9.10 Phase Optimizer

The phase optimizer allows time aligning the 2.0 (tweeter) path with the 0.1 (woofer) path. A programmable phase delay of up to 16 samples can be achieved for both the tweeter and woofer. The

[Phase Delay Tuning Window](#) pops up if the  icon on the top right of the *Crossover Tuning Window* is clicked.

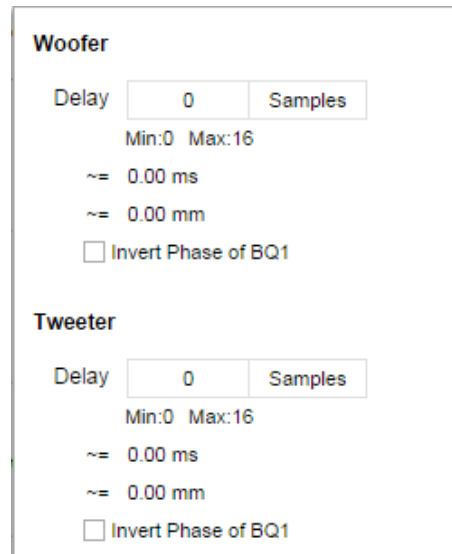

Figure 26. Phase Delay Tuning Window

9.11 Clipper

A clipper can be used to digitally achieve the specified THD levels without voltage clipping. It allows users to achieve the same THD (for example, 10% THD) for different power levels (15 W, 10 W, 5 W) with same PVCC level.

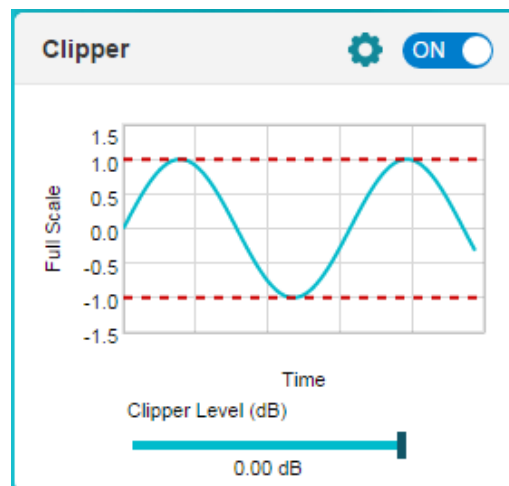

Figure 27. Clipper

Clipper Level

The clipper level controls the signal level at which clipping occurs.

9.12 Output Crossbar

The crossbar provides the end user with a very flexible way to control what finally appears on amplifier outputs and I2S SDOOUT. The *Basic* tab provides the easiest way for configuration. Go to the *Advanced* tab if more parameters need to be adjusted. Note that all the parameters need to be specified in decibels (dB).

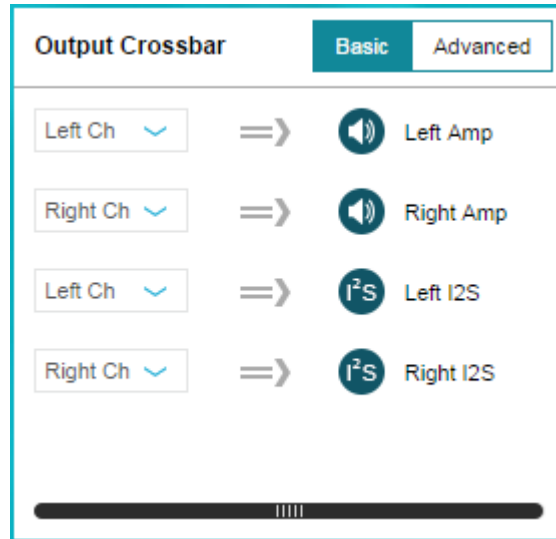

Figure 28. Output Crossbar (Basic Tab)

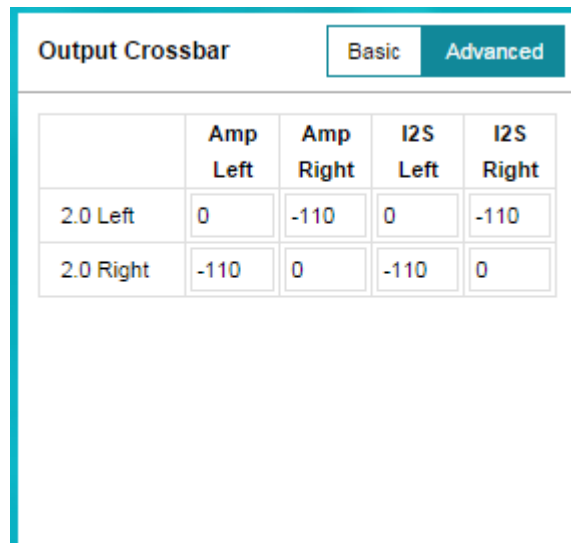

Figure 29. Output Crossbar (Advanced Tab)

10 Smart Amp

Conventional hardware-based speaker protection matches the continuous power output of the audio amplifier with the speaker output rating and sometimes incorporates high-pass filtering to prevent over-excursion.

If the maximum output voltage limit of a traditional system is based on the average power of a full-scale sinusoid, there is risk of voice coil overheating if a square wave is provided as an input. This is due to the fact that a square wave has 6 dB higher average power than a sinusoid of the same peak amplitude as well as having the presence of higher-frequency components. Conservative designs may then have to trade off *sound pressure level* (SPL) with reliability.

More advanced methods to control load power include the use of limiters and dynamic range compressors. These methods can protect the speaker; however, peaks may be clipped or greatly reduced, especially on source material with high peak-to-average ratios (PAR).

PurePath™ Smart Amp replaces hardware-based speaker protection methods with predictive algorithms, speaker characterization tools, and real-time signal monitoring to increase the peak output of the speaker without damage.

Figure 30 and Figure 31 are actual song clips comparing the traditional method (left) against *Smart Amp* (right) to control output power. The dashed lines correspond to the output limit of a traditional system. Note that the average power (Pave) is increased while allowing peaks to cross the output limit.

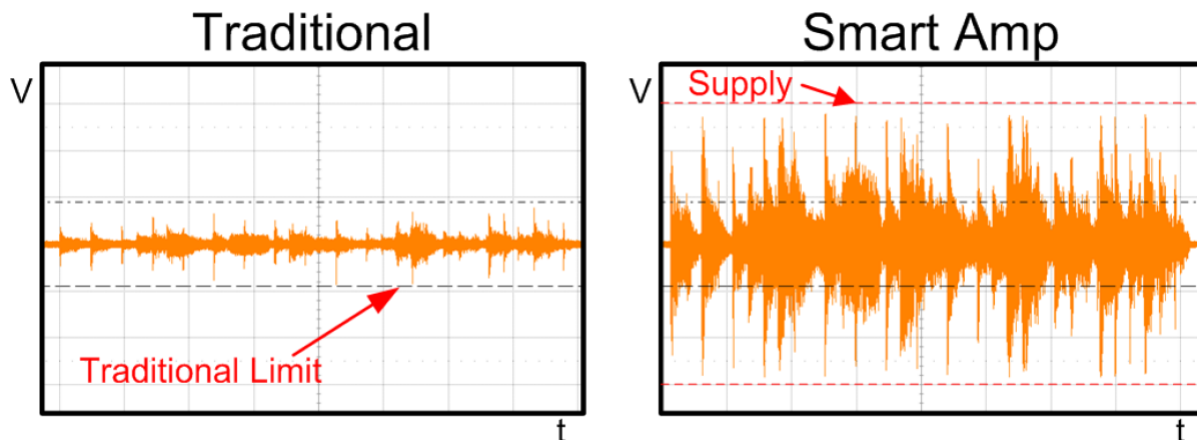

Figure 30. Audio Clip A, 22-dB Peak-to-Average Ratio Source

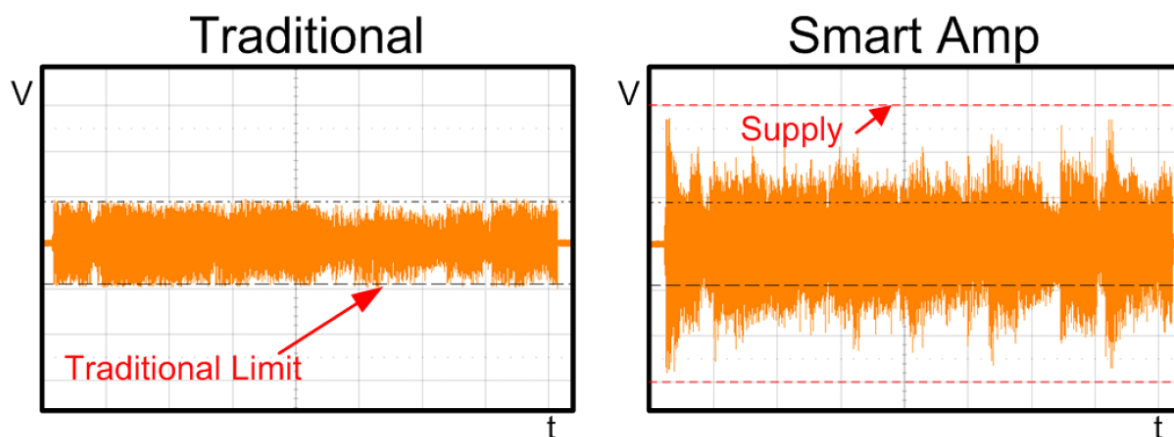

Figure 31. Audio Clip B, 9-dB Peak-to-Average Ratio Source

The first implementation step of *Smart Amp*-based audio solutions is characterizing the speaker with TI's *PurePath Console 3* and the *PurePath Learning Board*. These are powerful, easy-to-use tools designed specifically to simplify system-level characterization, tuning, and implementation. The characterization process creates a digital model of the speaker based on *thermal*, *electro-mechanical* and *acoustic* parameters.

The output of the characterization process is an initial set of coefficients that define the *Safe Operating Area (SOA)* which establishes the boundaries of maximum speaker diaphragm excursion and voice-coil temperature during operation. If the *SOA* is set correctly, the audio engineer need not worry about speaker damage during the audio tuning process – depending on how hard the system is pushed – audio might sound more or less desirable, but speaker safety is ensured if configured properly.

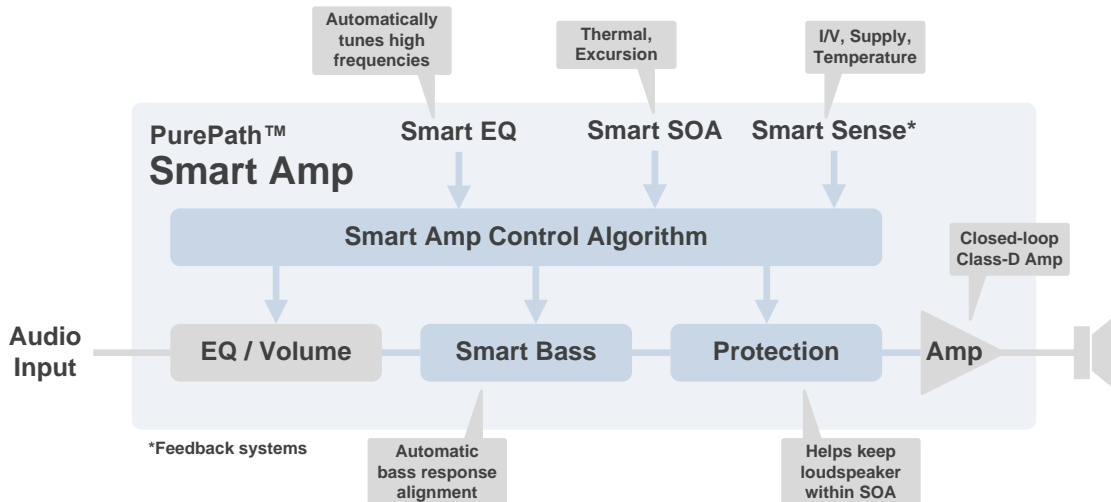
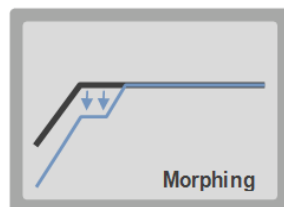
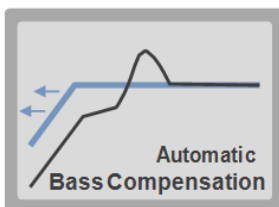

Figure 32. PurePath™ Smart Amp Block Diagram

PurePath Smart Amp technology enables significant sound quality and system reliability improvements while reducing component size and cost. The *PurePath Console 3* GUI and *Learning Board* speaker characterization hardware provide simple configuration of advanced properties fully describing the acoustical, electrical, *thermal* and reliability capabilities of an audio system and simplifying system-level characterization, tuning, and integration.

10.1 Smart Amp Features



Smart Bass

Bass can easily be *extended* into any alignment automatically. As signal amplitude is increased in the bass region, *Smart Bass* automatically *morphs* the response to accommodate for larger excursion.

Smart SPL

High-frequency behavior of the loudspeaker diaphragm cannot be obtained electrically. Similarly, it is difficult to obtain accurate low-frequency acoustical measurements without an expensive anechoic chamber. Smart SPL automatically merges electrical and acoustical measurements to create a *full picture of the SPL response*.

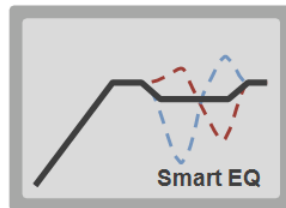
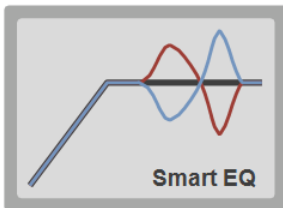
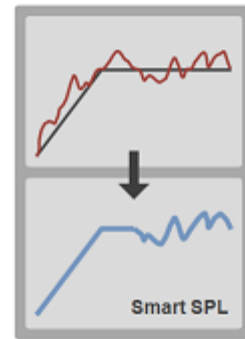

Smart EQ

Automatically and efficiently tunes *high frequencies* to deliver a *flat response* or match a *target curve* in seconds.

Thermal and Excursion Protection

The *Smart Amp* algorithm understands the thermal and excursion limitations of the speaker. This allows to drive it at peak levels much louder than conventional amplifiers while keeping the voice coil temperature and excursion within the specified limits. This results in louder audio playback.

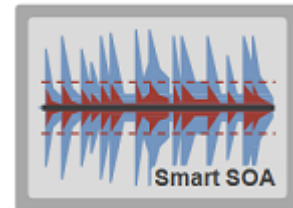

10.2 Smart Amp Development Overview

The following steps summarize *Smart Amp* evaluation, planning, characterization, tuning, and integration:

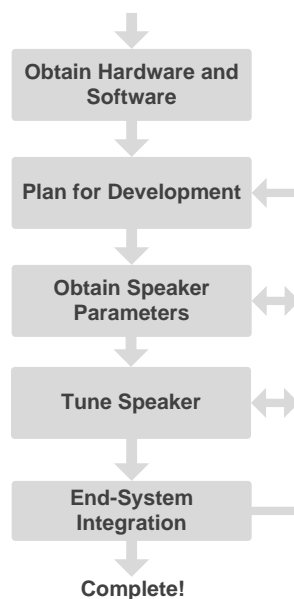

Figure 33. Smart Amp Development Overview

- Step 1. **Obtain Hardware and Software** – Speaker characterization and tuning are performed using the *PurePath Console 3* software. The *TI Learning Board* and the *Smart Amp Target EVM* are needed in order to fully evaluate and develop with *Smart Amp*.
- Step 2. **Plan for Development** – Developing *Smart Amp*-based systems for the first time can be different than working with conventional amplifiers. Information obtained during the speaker characterization process often leads to changes to the speaker or enclosure to maximize output and quality.
- Step 3. **Obtain Speaker Parameters** – The next step is to understand the characteristics of the speaker to be tested. Once a speaker is characterized, the ppc3 file obtained from this step will be used on the next step.
- Step 4. **Tune Speaker** – Once the speaker data is obtained, a speaker can be tuned using the *Target EVM* by importing a ppc3 file.
- Step 5. **End-System Integration** – *Smart Amp* fundamentally shifts how audio systems are designed. Using the *Smart Amp* tool set, a designer gathers an in-depth understanding of speaker *electro-mechanical*, thermal and acoustic parameters. Based on these parameters, *Smart Amp* algorithms deliver high peak voltage and current to the speaker while protecting the speaker from excessive heat or movement. Increased voltage and current levels lead to changes in the system power design. For these reasons, it is important to understand the power supply requirements early in the design.

11 Loudspeaker Characterization

The main objective of the loudspeaker characterization is to obtain the *electro-mechanical* and thermal parameters and establish the SOA of the loudspeaker system. The *electro-mechanical* and thermal parameters are obtained using the *Learning Board*.

The *Learning Board App* has a step-by-step wizard that guides the user through the entire loudspeaker characterization process.

11.1 Characterization Process

To perform a loudspeaker characterization:

1. Connect the *Learning Board* to your PC using the USB cable.
 - a. Provide a power supply
 - b. Do not connect the speakers, yet
2. In *PurePath Console 3*, open the *Learning Board App* and select **New**

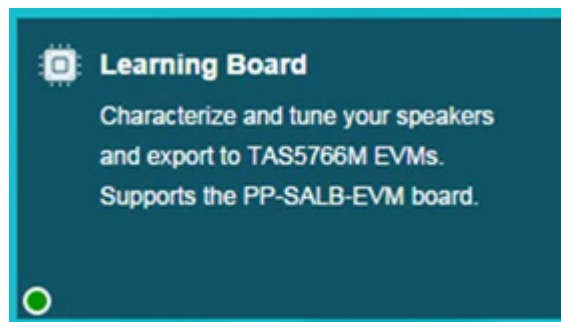

3. If the *Learning Board* is shown as offline, click **Connect**

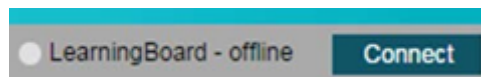

4. Click **Characterization**

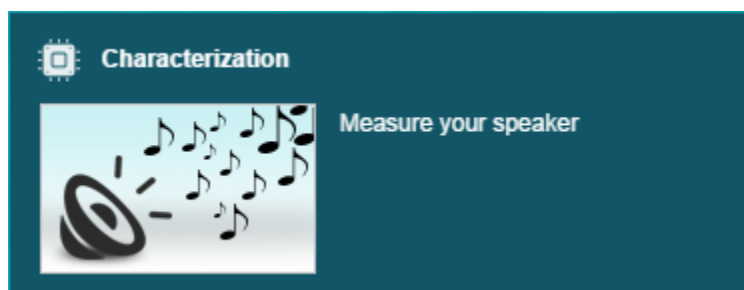

5. Follow the step-by-step wizard until the characterization is complete



6. Once complete, the *Characterization Summary* page is shown

11.2 Characterization Summary Page

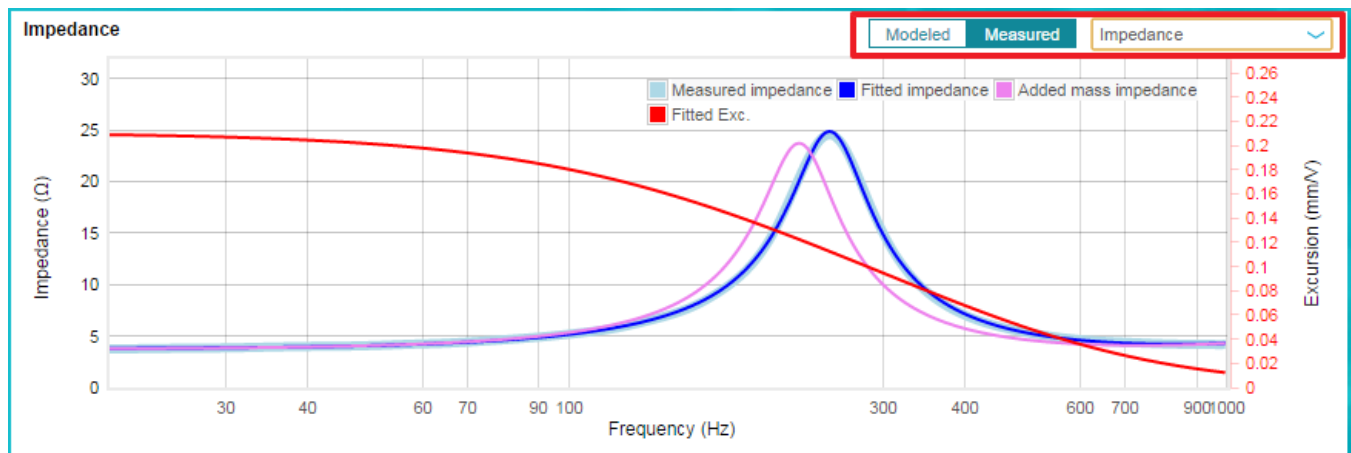
The *Characterization Summary* page shows the results of the loudspeaker characterization. To verify the loudspeaker plots, use the controls on the top of the graph to select between Modeled SPL and Excursion or Measured Impedance, Temperature, and SPL plots.



Driver and enclosure parameters are also shown as well as the established *Safe Operating Area* (SOA).

If desired, click the  button to redo the characterization. The  button will bring back the *Characterization Summary* page.

11.3 Saving a Characterization

The characterization data can be saved by clicking the  button at the *Title Bar* and selecting *Save*. This will output a .ppc3 file. This .ppc3 file can later be imported into the *Target EVM App* for tuning.

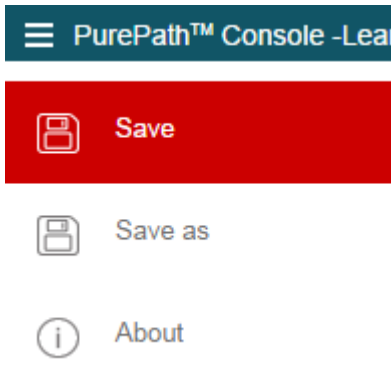

12 Smart Amp Tuning

Tuning is a process involving both subjective and methodical approaches. This section provides guidelines to help establish a baseline to achieve the best possible tuning. The main objectives of the (iterative) audio tuning process, also referred to as ‘voicing’, are:

- Improve bass performance using *Smart Bass* controls by adjusting:
 - Bass Enhancement ([Section 12.2.1](#))
 - Morphing Control ([Section 12.2.2](#))
 - Harmonic Bass Alignment ([Section 12.2.3](#))
- Improve high frequency response using Equalizer

The *Smart Amp Tuning Process* is summarized in [Figure 34](#).

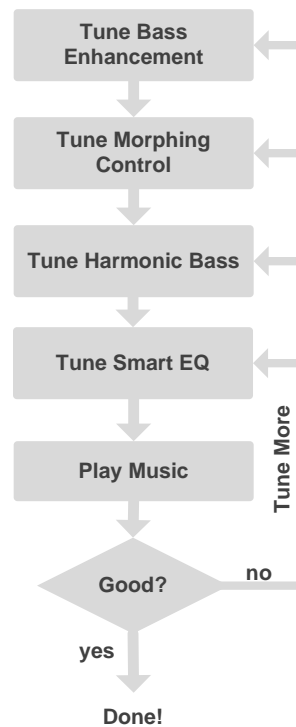

Figure 34. Smart Amp Tuning Process

12.1 Tuning Preparation

Tuning is performed using the TAS5782MEVM:

1. *Connect* the TAS5782MEVM to your PC using the USB cable.
 - Provide a power supply (matching the one to be used in the final system)
 - *Connect* the loudspeaker

- In PurePath Console 3, open the *TAS5782 App*.



- If the board is shown as offline, click **Connect**.

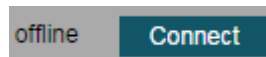

- Click **Tuning and Audio Processing**.

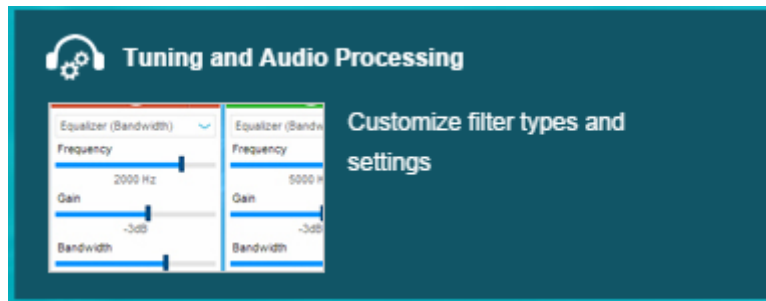

- Select a *SmartAmp Processing* (48k or 96k).

| Feature | Select Audio Mode | | | |
|--|-------------------------------|-------------------------------|-------------------------------|-------------------------------|
| | Standard Processing (2.0 96k) | SmartAmp Processing (2.0 96k) | Standard Processing (2.0 48k) | SmartAmp Processing (2.0 48k) |
| Maximum Internal Sample Rate | 96k | 96k | 48k | 48k |
| SRC (2x Decimator) and Auto-detect 96k->48k or 88.2k->44.1k | ✗ | ✗ | ✓ | ✓ |
| Supported Input Sample Rates 16k, 32k, 44.1k, 48k, 88.2k, 96k | ✓ | ✓ | ✓ | ✓ |
| Biquads for EQ filtering (Individual left/right) | 12 | 12 | 15 | 15 |
| Input Mixer | ✓ | ✓ | ✓ | ✓ |
| Click & Pop Free Volume | ✓ | ✓ | ✓ | ✓ |
| Spatializer (Stereo Widening) | ✗ | ✗ | ✓ | ✓ |
| Dynamic Biquad | ✗ | ✗ | ✓ | ✓ |
| Bass Mono Mixer | ✗ | ✗ | ✓ | ✓ |
| 3 Band DRC (4th order) | ✓ | ✗ | ✓ | ✗ |
| Automatic Gain Limiter | ✓ | ✗ | ✓ | ✗ |
| Smart Excursion, Smart Thermal and Smart Bass Tuning  | ✗ | ✓ | ✗ | ✓ |
| Output Clipper | ✓ | ✓ | ✓ | ✓ |
| | Select | Select | Select | Select |

- Import** the characterization data that was obtained during the Characterization process by clicking the **Import** button.



- Click and perform a **System Calibration**. This process ensures that the *Smart Amp* algorithm is properly scaled based on the amplifier output gain.

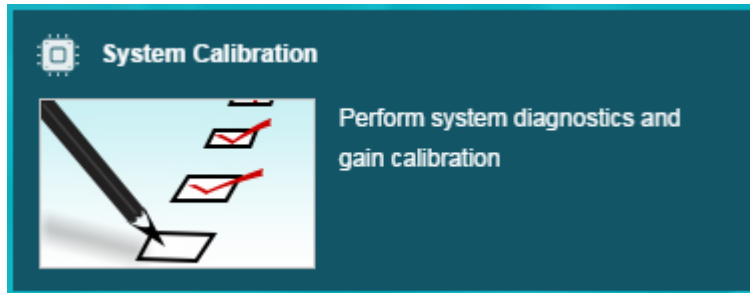

12.2 Smart Bass Tuning

During the characterization process, the low-frequency SPL model of the loudspeaker was obtained. Based on this model, the response is automatically optimized to match popular loudspeaker alignment types (that is Butterworth, Linkwitz-Riley, and so forth). This allows the audio engineer to focus on choosing the desired sound with just a few clicks.

When tuning *Smart Bass* for the first time, it is best to first disable the *Equalizer*.

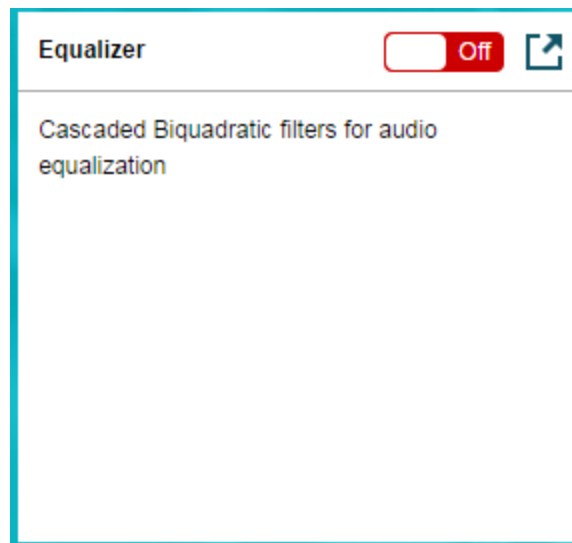

To start tuning *Smart Bass*, enable *Smart Bass* and click the Expand symbol, as shown in the following image.

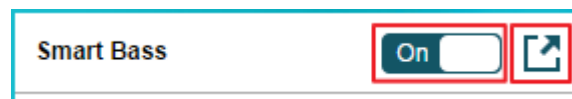

The *Smart Bass Tuning* page has all the controls needed for *Smart Bass* tuning. Several plots (such as Excursion) are provided as an aid to the tuning process.

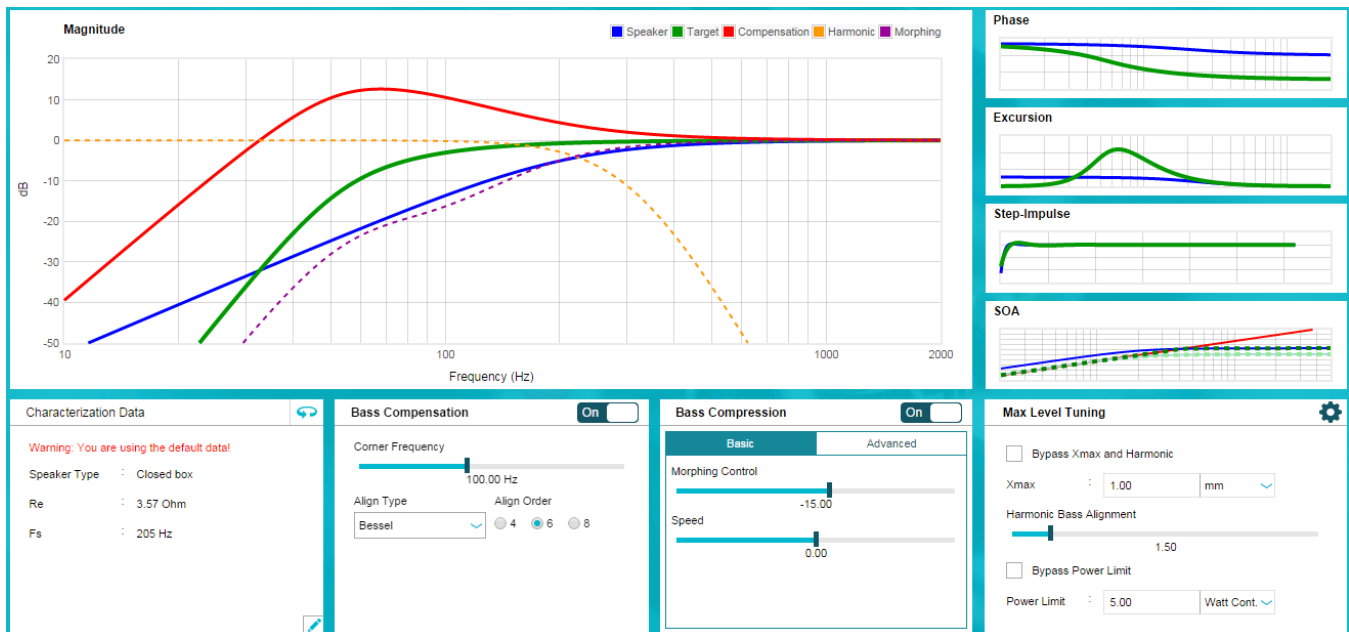
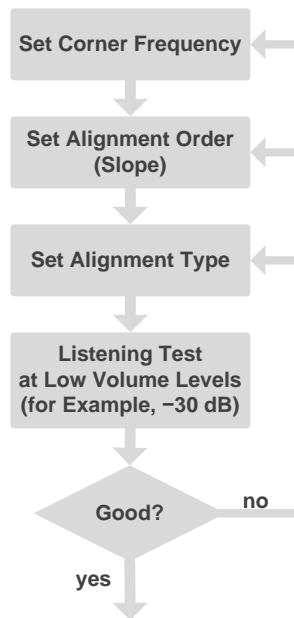

Figure 35. Smart Amp Tuning Page

12.2.1 Bass Enhancement (Low Volume Tuning)

The main objective is to maximize the bass response as much as possible and tune the bass, as desired. During this phase, it is important to listen at low volume levels only – this is to ensure that thermal and mechanical protection systems do not kick-in. Ensure that the *Morphing Control* (Section 12.2.2) is set at maximum during this phase.



Continue to [Section 12.2.2.](#)

Table 6. Bass Enhancement Parameters

| Field | Description |
|------------------|--|
| Corner Frequency | -3-dB point of the target response. Smaller speaker drivers should use higher corner frequency. |
| Order (Slope) | Determines the sharpness of the roll-off towards lower frequencies. For lower corner frequency, choose higher order. |
| Type | Selects the alignment type |

Corner Frequency

The *Corner Frequency* indicates the -3-dB point of a flat response target (indicated by the green curve in the following image). Selecting a proper *Corner Frequency* is important for the overall performance of the speaker system. If the cutoff is set too high, the speaker will have limited bass response. If set too low, energy will be wasted trying to drive frequencies that the speaker will not be able to reproduce and the excursion protection system will be overly active.

TI recommends doing a series of listening tests while adjusting settings.

- Adjust *Corner Frequency* while watching the compensation (red curve) in the response plot window.
- Targeting between a 10- to 20-dB compensation (red curve) often provides the best results.
- Do not exceed the 20-dB line (at least initially).

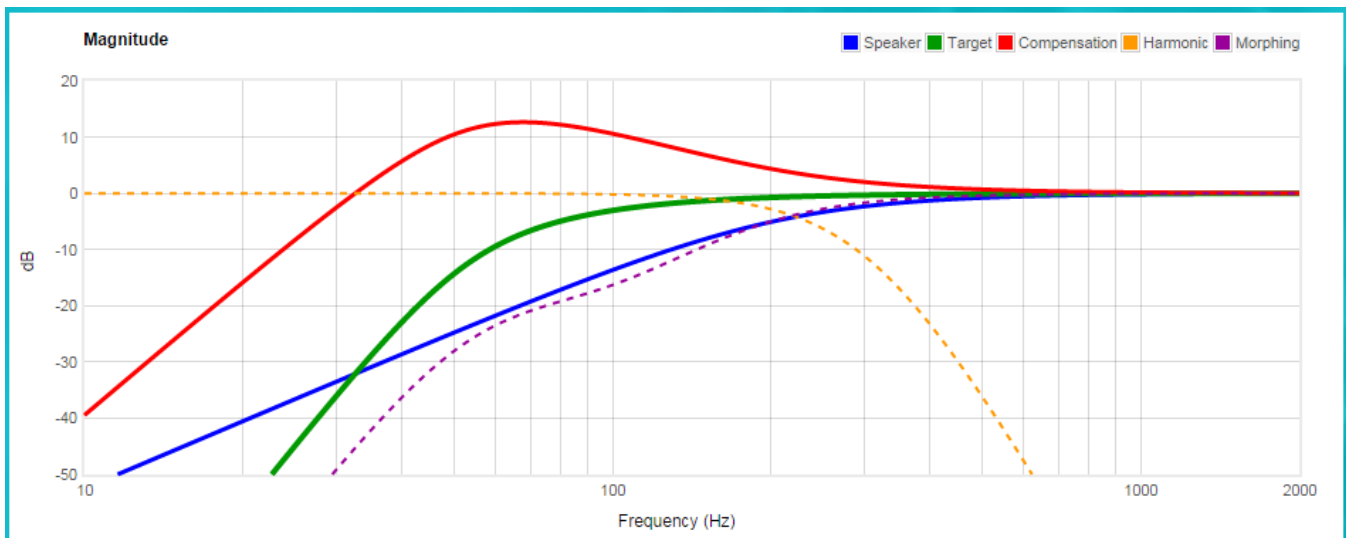

Alignment Order and Type

The *Order and Type* determine the bass roll-off. In other words, it determines what occurs below the corner frequency.



A high-order roll-off cuts bass faster, saving power and limiting speaker excursion that will not produce much SPL. Likewise, *Type* has significant influence on the SPL and energy below the corner frequency.

- Select a higher order if the speaker handles excursion poorly.
- Select a lower order to leave small amounts of low-frequency content in the signal.
- Butterworth is suitable for most applications. For ported or passive radiator systems that can reproduce 60–80 Hz, a Chebyshev alignment works well.

12.2.2 Morphing Control (Mid- to High-Volume Tuning)

Morphing determines the headroom dependent balance between *Bass Enhancement* and *Harmonic Bass Alignment*. As excursion and thermal headroom drops with increase in music loudness, the *Morphing* feature gradually and dynamically reduces bass.

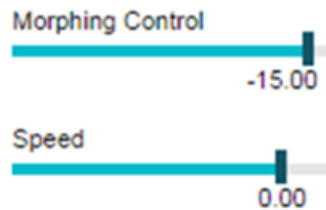

Depending on *Speed* and *Harmonic Alignment* settings, some residue of bass harmonics might remain in the frequency spectrum creating a psychoacoustic bass enhancement effect.

- Audible artifacts indicate too high Morphing setting
- Little but clean bass could indicate that the Morphing setting is too low

From [Section 12.2.1](#)

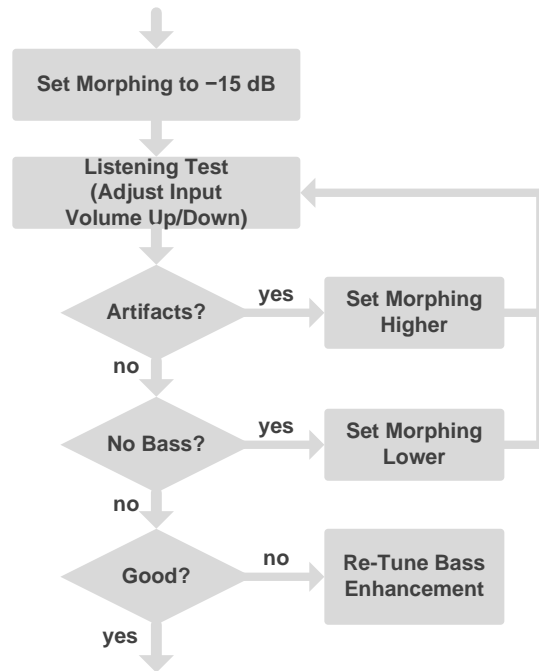

Continue to [Section 12.2.3](#)

NOTE: This is an iterative process! It is important to listen to different types of music and at several volume settings (listening levels).

Morphing Speed (Optional)

The *Morphing Speed* control determines the aggressiveness on which the *Smart Amp* algorithm adapts to a change of headroom.

Speakers react very differently to morphing speed and unfortunately there is no universal guideline for how to tune this for the best setting. TI recommends experimenting with several settings. This setting may also be left at the default value (0).

- Listen to different music types at moderate to high volume levels
- Listen for audible artifacts such as:
 - **Bass region:** distortion, especially with high transients (such as a kick drum)
 - **Mid/high range:** distortion, modulation artifacts

12.2.3 Harmonic Bass Alignment (Mid- to High-Volume Tuning)

The *Harmonic Bass Alignment* control determines the aggressiveness of the excursion protection algorithm as speaker headroom is reduced. Some speakers sound great with an aggressive setting (high value) where other speakers, typically of lower quality, will sound harsh and distorted and will require less aggressive setting (lower value).

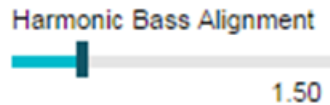

- Listen to different music types at moderate to high volume levels
- Listen for audible artifacts such as:
 - **Bass region:** distortion, especially with high transients (such as a kick drum)
 - **Mid/High range:** distortion

From [Section 12.2.2](#)

To [Section 12.2.1](#)

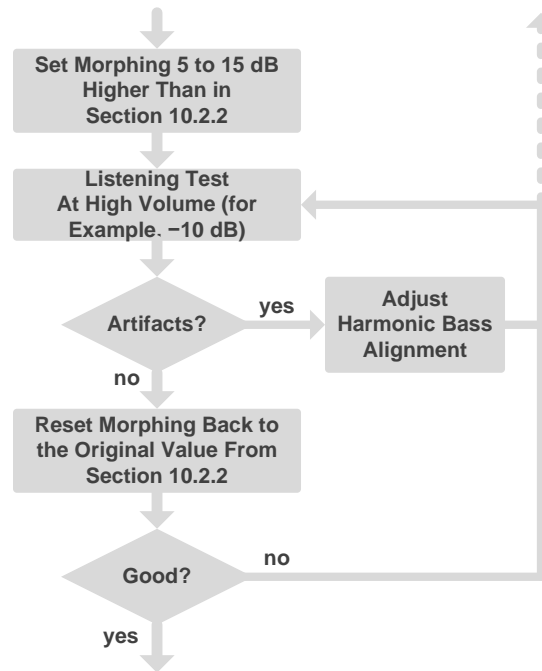

Continue to [Section 12.2.4](#)

12.2.4 Excursion Tuning (Optional)

Depending on the type and quality of the speaker (as characterized in the measurement phase), the *Peak Excursion SOA* setting sometimes needs a post-audio-tuning adjustment for best sound quality. As a typical speaker approaches its *Xmax* the THD tends to rise quickly. This behavior can have an amplifying effect on artifacts.

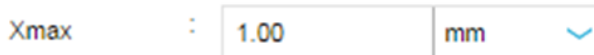

- In the *Max Level Tuning* window, change the peak excursion limit value while you listen to audio.
- Reduce it if there are Artifacts at high volume settings.

From [Section 12.2.3](#)

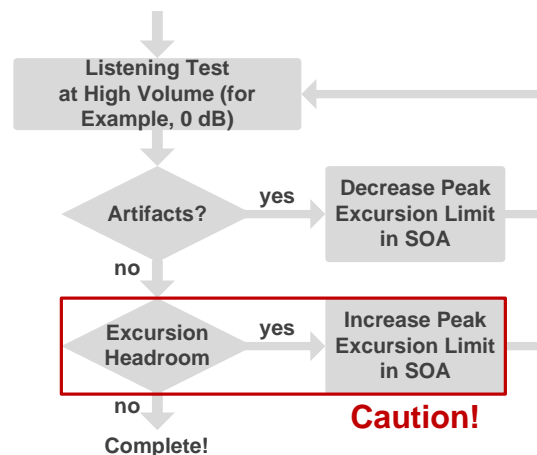

Caution!

DSP Memory Map

A.1 DSP Memory Map for Process Flow 1

Table 7 lists the DSP memory map for process flow 1.

Table 7. DSP Memory Map for Process Flow 1 — Book 0x8C

| Sub Address | Page | Register Name | Number of Bytes/Format | Default Value | Description |
|-----------------------|------|---------------|------------------------|---------------|----------------------|
| DRC 1 BQ | | | | | |
| 0x30 | 0x13 | BQ B0 | 4 / 1.31 | 0x7FFFFFFF | DRC 1 BQ coefficient |
| 0x34 | 0x13 | BQ B1 | 4 / 2.30 | 0x00000000 | DRC 1 BQ coefficient |
| 0x38 | 0x13 | BQ B2 | 4 / 1.31 | 0x00000000 | DRC 1 BQ coefficient |
| 0x3C | 0x13 | BQ A1 | 4 / 2.30 | 0x00000000 | DRC 1 BQ coefficient |
| 0x40 | 0x13 | BQ A2 | 4 / 1.31 | 0x00000000 | DRC 1 BQ coefficient |
| DRC 3 BQ | | | | | |
| 0x58 | 0x13 | BQ B0 | 4 / 1.31 | 0x7FFFFFFF | DRC 3 BQ coefficient |
| 0x5C | 0x13 | BQ B1 | 4 / 2.30 | 0x00000000 | DRC 3 BQ coefficient |
| 0x60 | 0x13 | BQ B2 | 4 / 1.31 | 0x00000000 | DRC 3 BQ coefficient |
| 0x64 | 0x13 | BQ A1 | 4 / 2.30 | 0x00000000 | DRC 3 BQ coefficient |
| 0x68 | 0x13 | BQ A2 | 4 / 1.31 | 0x00000000 | DRC 3 BQ coefficient |
| DRC 2 BQ | | | | | |
| 0x08 | 0x14 | BQ 1 B0 | 4 / 1.31 | 0x7FFFFFFF | DRC 2 BQ coefficient |
| 0x0C | 0x14 | BQ 1 B1 | 4 / 2.30 | 0x00000000 | DRC 2 BQ coefficient |
| 0x10 | 0x14 | BQ 1 B2 | 4 / 1.31 | 0x00000000 | DRC 2 BQ coefficient |
| 0x14 | 0x14 | BQ 1 A1 | 4 / 2.30 | 0x00000000 | DRC 2 BQ coefficient |
| 0x18 | 0x14 | BQ 1 A2 | 4 / 1.31 | 0x00000000 | DRC 2 BQ coefficient |
| 0x1C | 0x14 | BQ 2 B0 | 4 / 1.31 | 0x7FFFFFFF | DRC 2 BQ coefficient |
| 0x20 | 0x14 | BQ 2 B1 | 4 / 2.30 | 0x00000000 | DRC 2 BQ coefficient |
| 0x24 | 0x14 | BQ 2 B2 | 4 / 1.31 | 0x00000000 | DRC 2 BQ coefficient |
| 0x28 | 0x14 | BQ 2 A1 | 4 / 2.30 | 0x00000000 | DRC 2 BQ coefficient |
| 0x2C | 0x14 | BQ 2 A2 | 4 / 1.31 | 0x00000000 | DRC 2 BQ coefficient |
| EQ LEFT 11 BQs | | | | | |
| 0x1C | 0x16 | CH -L BQ 1 B0 | 4 / 1.31 | 0x7FFFFFFF | Left BQ coefficient |
| 0x20 | 0x16 | CH -L BQ 1 B1 | 4 / 2.30 | 0x00000000 | Left BQ coefficient |
| 0x24 | 0x16 | CH -L BQ 1 B2 | 4 / 1.31 | 0x00000000 | Left BQ coefficient |
| 0x28 | 0x16 | CH -L BQ 1 A1 | 4 / 2.30 | 0x00000000 | Left BQ coefficient |
| 0x2C | 0x16 | CH -L BQ 1 A2 | 4 / 1.31 | 0x00000000 | Left BQ coefficient |
| 0x30 | 0x16 | CH -L BQ 2 B0 | 4 / 1.31 | 0x7FFFFFFF | Left BQ coefficient |
| 0x34 | 0x16 | CH -L BQ 2 B1 | 4 / 2.30 | 0x00000000 | Left BQ coefficient |
| 0x38 | 0x16 | CH -L BQ 2 B2 | 4 / 1.31 | 0x00000000 | Left BQ coefficient |
| 0x3C | 0x16 | CH -L BQ 2 A1 | 4 / 2.30 | 0x00000000 | Left BQ coefficient |
| 0x40 | 0x16 | CH -L BQ 2 A2 | 4 / 1.31 | 0x00000000 | Left BQ coefficient |
| 0x44 | 0x16 | CH -L BQ 3 B0 | 4 / 1.31 | 0x7FFFFFFF | Left BQ coefficient |
| 0x48 | 0x16 | CH -L BQ 3 B1 | 4 / 2.30 | 0x00000000 | Left BQ coefficient |
| 0x4C | 0x16 | CH -L BQ 3 B2 | 4 / 1.31 | 0x00000000 | Left BQ coefficient |
| 0x50 | 0x16 | CH -L BQ 3 A1 | 4 / 2.30 | 0x00000000 | Left BQ coefficient |

Table 7. DSP Memory Map for Process Flow 1 — Book 0x8C (continued)

| Sub Address | Page | Register Name | Number of Bytes/Format | Default Value | Description |
|------------------------|------|----------------|------------------------|---------------|--------------------------------|
| 0x54 | 0x16 | CH -L BQ 3 A2 | 4 / 1.31 | 0x00000000 | Left BQ coefficient |
| 0x58 | 0x16 | CH -L BQ 4 B0 | 4 / 1.31 | 0x7FFFFFFF | Left BQ coefficient |
| 0x5C | 0x16 | CH -L BQ 4 B1 | 4 / 2.30 | 0x00000000 | Left BQ coefficient |
| 0x60 | 0x16 | CH -L BQ 4 B2 | 4 / 1.31 | 0x00000000 | Left BQ coefficient |
| 0x64 | 0x16 | CH -L BQ 4 A1 | 4 / 2.30 | 0x00000000 | Left BQ coefficient |
| 0x68 | 0x16 | CH -L BQ 4 A2 | 4 / 1.31 | 0x00000000 | Left BQ coefficient |
| 0x6C | 0x16 | CH -L BQ 5 B0 | 4 / 1.31 | 0x7FFFFFFF | Left BQ coefficient |
| 0x70 | 0x16 | CH -L BQ 5 B1 | 4 / 2.30 | 0x00000000 | Left BQ coefficient |
| 0x74 | 0x16 | CH -L BQ 5 B2 | 4 / 1.31 | 0x00000000 | Left BQ coefficient |
| 0x78 | 0x16 | CH -L BQ 5 A1 | 4 / 2.30 | 0x00000000 | Left BQ coefficient |
| 0x7C | 0x16 | CH -L BQ 5 A2 | 4 / 1.31 | 0x00000000 | Left BQ coefficient |
| 0x08 | 0x17 | CH -L BQ 6 B0 | 4 / 1.31 | 0x7FFFFFFF | Left BQ coefficient |
| 0x0C | 0x17 | CH -L BQ 6 B1 | 4 / 2.30 | 0x00000000 | Left BQ coefficient |
| 0x10 | 0x17 | CH -L BQ 6 B2 | 4 / 1.31 | 0x00000000 | Left BQ coefficient |
| 0x14 | 0x17 | CH -L BQ 6 A1 | 4 / 2.30 | 0x00000000 | Left BQ coefficient |
| 0x18 | 0x17 | CH -LBQ 6 A2 | 4 / 1.31 | 0x00000000 | Left BQ coefficient |
| 0x1C | 0x17 | CH -L BQ 7 B0 | 4 / 1.31 | 0x7FFFFFFF | Left BQ coefficient |
| 0x20 | 0x17 | CH -L BQ 7 B1 | 4 / 2.30 | 0x00000000 | Left BQ coefficient |
| 0x24 | 0x17 | CH -L BQ 7 B2 | 4 / 1.31 | 0x00000000 | Left BQ coefficient |
| 0x28 | 0x17 | CH -L BQ 7 A1 | 4 / 2.30 | 0x00000000 | Left BQ coefficient |
| 0x2C | 0x17 | CH -L BQ 7 A2 | 4 / 1.31 | 0x00000000 | Left BQ coefficient |
| 0x30 | 0x17 | CH -L BQ 8 B0 | 4 / 1.31 | 0x7FFFFFFF | Left BQ coefficient |
| 0x34 | 0x17 | CH -L BQ 8 B1 | 4 / 2.30 | 0x00000000 | Left BQ coefficient |
| 0x38 | 0x17 | CH -L BQ 8 B2 | 4 / 1.31 | 0x00000000 | Left BQ coefficient |
| 0x3C | 0x17 | CH -L BQ 8 A1 | 4 / 2.30 | 0x00000000 | Left BQ coefficient |
| 0x40 | 0x17 | CH -L BQ 8 A2 | 4 / 1.31 | 0x00000000 | Left BQ coefficient |
| 0x44 | 0x17 | CH -L BQ 9 B0 | 4 / 1.31 | 0x7FFFFFFF | Left BQ coefficient |
| 0x48 | 0x17 | CH -L BQ 9 B1 | 4 / 2.30 | 0x00000000 | Left BQ coefficient |
| 0x4C | 0x17 | CH -L BQ 9 B2 | 4 / 1.31 | 0x00000000 | Left BQ coefficient |
| 0x50 | 0x17 | CH -L BQ 9 A1 | 4 / 2.30 | 0x00000000 | Left BQ coefficient |
| 0x54 | 0x17 | CH -L BQ 9 A2 | 4 / 1.31 | 0x00000000 | Left BQ coefficient |
| 0x58 | 0x17 | CH -L BQ 10 B0 | 4 / 1.31 | 0x7FFFFFFF | Left BQ coefficient |
| 0x5C | 0x17 | CH -L BQ 10 B1 | 4 / 2.30 | 0x00000000 | Left BQ coefficient |
| 0x60 | 0x17 | CH -L BQ 10 B2 | 4 / 1.31 | 0x00000000 | Left BQ coefficient |
| 0x64 | 0x17 | CH -L BQ 10 A1 | 4 / 2.30 | 0x00000000 | Left BQ coefficient |
| 0x68 | 0x17 | CH -L BQ 10 A2 | 4 / 1.31 | 0x00000000 | Left BQ coefficient |
| 0x6C | 0x17 | CH -L BQ 11 B0 | 4 / 1.31 | 0x7FFFFFFF | Left BQ coefficient |
| 0x70 | 0x17 | CH -L BQ 11 B1 | 4 / 2.30 | 0x00000000 | Left BQ coefficient |
| 0x74 | 0x17 | CH -L BQ 11 B2 | 4 / 1.31 | 0x00000000 | Left BQ coefficient |
| 0x78 | 0x17 | CH -L BQ 11 A1 | 4 / 2.30 | 0x00000000 | Left BQ coefficient |
| 0x7C | 0x17 | CH -L BQ 11 A2 | 4 / 1.31 | 0x00000000 | Left BQ coefficient |
| LEFT INTGAIN BQ | | | | | |
| 0x08 | 0x18 | CH -L BQ 12 B0 | 4 / 5.27 | 0x08000000 | Left gain scale BQ coefficient |
| 0x0C | 0x18 | CH -L BQ 12 B1 | 4 / 6.26 | 0x00000000 | Left gain scale BQ coefficient |
| 0x10 | 0x18 | CH -L BQ 12 B2 | 4 / 5.27 | 0x00000000 | Left gain scale BQ coefficient |
| 0x14 | 0x18 | CH -L BQ 12 A1 | 4 / 2.30 | 0x00000000 | Left gain scale BQ coefficient |
| 0x18 | 0x18 | CH -L BQ 12 A2 | 4 / 1.31 | 0x00000000 | Left gain scale BQ coefficient |
| EQ RIGHT 11 BQs | | | | | |
| 0x58 | 0x18 | CH -R BQ 1 B0 | 4 / 1.31 | 0x7FFFFFFF | Right BQ coefficient |
| 0x5C | 0x18 | CH -R BQ 1 B1 | 4 / 2.30 | 0x00000000 | Right BQ coefficient |
| 0x60 | 0x18 | CH -R BQ 1 B2 | 4 / 1.31 | 0x00000000 | Right BQ coefficient |

Table 7. DSP Memory Map for Process Flow 1 — Book 0x8C (continued)

| Sub Address | Page | Register Name | Number of Bytes/Format | Default Value | Description |
|-------------|------|----------------|------------------------|---------------|----------------------|
| 0x64 | 0x18 | CH -R BQ 1 A1 | 4 / 2.30 | 0x00000000 | Right BQ coefficient |
| 0x68 | 0x18 | CH -R BQ 1 A2 | 4 / 1.31 | 0x00000000 | Right BQ coefficient |
| 0x6C | 0x18 | CH -R BQ 2 B0 | 4 / 1.31 | 0x7FFFFFFF | Right BQ coefficient |
| 0x70 | 0x18 | CH -R BQ 2 B1 | 4 / 2.30 | 0x00000000 | Right BQ coefficient |
| 0x74 | 0x18 | CH -R BQ 2 B2 | 4 / 1.31 | 0x00000000 | Right BQ coefficient |
| 0x78 | 0x18 | CH -R BQ 2 A1 | 4 / 2.30 | 0x00000000 | Right BQ coefficient |
| 0x7C | 0x18 | CH -R BQ 2 A2 | 4 / 1.31 | 0x00000000 | Right BQ coefficient |
| 0x08 | 0x19 | CH -R BQ 3 B0 | 4 / 1.31 | 0x7FFFFFFF | Right BQ coefficient |
| 0x0C | 0x19 | CH -R BQ 3 B1 | 4 / 2.30 | 0x00000000 | Right BQ coefficient |
| 0x10 | 0x19 | CH -R BQ 3 B2 | 4 / 1.31 | 0x00000000 | Right BQ coefficient |
| 0x14 | 0x19 | CH -R BQ 3 A1 | 4 / 2.30 | 0x00000000 | Right BQ coefficient |
| 0x18 | 0x19 | CH -R BQ 3 A2 | 4 / 1.31 | 0x00000000 | Right BQ coefficient |
| 0x1C | 0x19 | CH -R BQ 4 B0 | 4 / 1.31 | 0x7FFFFFFF | Right BQ coefficient |
| 0x20 | 0x19 | CH -R BQ 4 B1 | 4 / 2.30 | 0x00000000 | Right BQ coefficient |
| 0x24 | 0x19 | CH -R BQ 4 B2 | 4 / 1.31 | 0x00000000 | Right BQ coefficient |
| 0x28 | 0x19 | CH -R BQ 4 A1 | 4 / 2.30 | 0x00000000 | Right BQ coefficient |
| 0x2C | 0x19 | CH -R BQ 4 A2 | 4 / 1.31 | 0x00000000 | Right BQ coefficient |
| 0x30 | 0x19 | CH -R BQ 5 B0 | 4 / 1.31 | 0x7FFFFFFF | Right BQ coefficient |
| 0x34 | 0x19 | CH -R BQ 5 B1 | 4 / 2.30 | 0x00000000 | Right BQ coefficient |
| 0x38 | 0x19 | CH -R BQ 5 B2 | 4 / 1.31 | 0x00000000 | Right BQ coefficient |
| 0x3C | 0x19 | CH -R BQ 5 A1 | 4 / 2.30 | 0x00000000 | Right BQ coefficient |
| 0x40 | 0x19 | CH -R BQ 5 A2 | 4 / 1.31 | 0x00000000 | Right BQ coefficient |
| 0x44 | 0x19 | CH -R BQ 6 B0 | 4 / 1.31 | 0x7FFFFFFF | Right BQ coefficient |
| 0x48 | 0x19 | CH -R BQ 6 B1 | 4 / 2.30 | 0x00000000 | Right BQ coefficient |
| 0x4C | 0x19 | CH -R BQ 6 B2 | 4 / 1.31 | 0x00000000 | Right BQ coefficient |
| 0x50 | 0x19 | CH -R BQ 6 A1 | 4 / 2.30 | 0x00000000 | Right BQ coefficient |
| 0x54 | 0x19 | CH -R BQ 6 A2 | 4 / 1.31 | 0x00000000 | Right BQ coefficient |
| 0x58 | 0x19 | CH -R BQ 7 B0 | 4 / 1.31 | 0x7FFFFFFF | Right BQ coefficient |
| 0x5C | 0x19 | CH -R BQ 7 B1 | 4 / 2.30 | 0x00000000 | Right BQ coefficient |
| 0x60 | 0x19 | CH -R BQ 7 B2 | 4 / 1.31 | 0x00000000 | Right BQ coefficient |
| 0x64 | 0x19 | CH -R BQ 7 A1 | 4 / 2.30 | 0x00000000 | Right BQ coefficient |
| 0x68 | 0x19 | CH -R BQ 7 A2 | 4 / 1.31 | 0x00000000 | Right BQ coefficient |
| 0x6C | 0x19 | CH -R BQ 8 B0 | 4 / 1.31 | 0x7FFFFFFF | Right BQ coefficient |
| 0x70 | 0x19 | CH -R BQ 8 B1 | 4 / 2.30 | 0x00000000 | Right BQ coefficient |
| 0x74 | 0x19 | CH -R BQ 8 B2 | 4 / 1.31 | 0x00000000 | Right BQ coefficient |
| 0x78 | 0x19 | CH -R BQ 8 A1 | 4 / 2.30 | 0x00000000 | Right BQ coefficient |
| 0x7C | 0x19 | CH -R BQ 8 A2 | 4 / 1.31 | 0x00000000 | Right BQ coefficient |
| 0x08 | 0x1A | CH -R BQ 9 B0 | 4 / 1.31 | 0x7FFFFFFF | Right BQ coefficient |
| 0x0C | 0x1A | CH -R BQ 9 B1 | 4 / 2.30 | 0x00000000 | Right BQ coefficient |
| 0x10 | 0x1A | CH -R BQ 9 B2 | 4 / 1.31 | 0x00000000 | Right BQ coefficient |
| 0x14 | 0x1A | CH -R BQ 9 A1 | 4 / 2.30 | 0x00000000 | Right BQ coefficient |
| 0x18 | 0x1A | CH -R BQ 9 A2 | 4 / 1.31 | 0x00000000 | Right BQ coefficient |
| 0x1C | 0x1A | CH -R BQ 10 B0 | 4 / 1.31 | 0x7FFFFFFF | Right BQ coefficient |
| 0x20 | 0x1A | CH -R BQ 10 B1 | 4 / 2.30 | 0x00000000 | Right BQ coefficient |
| 0x24 | 0x1A | CH -R BQ 10 B2 | 4 / 1.31 | 0x00000000 | Right BQ coefficient |
| 0x28 | 0x1A | CH -R BQ 10 A1 | 4 / 2.30 | 0x00000000 | Right BQ coefficient |
| 0x2C | 0x1A | CH -R BQ 10 A2 | 4 / 1.31 | 0x00000000 | Right BQ coefficient |
| 0x30 | 0x1A | CH -R BQ 11 B0 | 4 / 1.31 | 0x7FFFFFFF | Right BQ coefficient |
| 0x34 | 0x1A | CH -R BQ 11 B1 | 4 / 2.30 | 0x00000000 | Right BQ coefficient |
| 0x38 | 0x1A | CH -R BQ 11 B2 | 4 / 1.31 | 0x00000000 | Right BQ coefficient |
| 0x3C | 0x1A | CH -R BQ 11 A1 | 4 / 2.30 | 0x00000000 | Right BQ coefficient |

Table 7. DSP Memory Map for Process Flow 1 — Book 0x8C (continued)

| Sub Address | Page | Register Name | Number of Bytes/Format | Default Value | Description |
|----------------------------|------|------------------------|------------------------|---------------|--------------------------------------|
| 0x40 | 0x1A | CH -R BQ 11 A2 | 4 / 1.31 | 0x00000000 | Right BQ coefficient |
| Right INTGAIN BQ | | | | | |
| 0x44 | 0x1A | CH -R BQ 12 B0 | 4 / 5.27 | 0x08000000 | Right gain scale BQ coefficient |
| 0x48 | 0x1A | CH -R BQ 12 B1 | 4 / 6.26 | 0x00000000 | Right gain scale BQ coefficient |
| 0x4C | 0x1A | CH -R BQ 12 B2 | 4 / 5.27 | 0x00000000 | Right gain scale BQ coefficient |
| 0x50 | 0x1A | CH -R BQ 12 A1 | 4 / 2.30 | 0x00000000 | Right gain scale BQ coefficient |
| 0x54 | 0x1A | CH -R BQ 12 A2 | 4 / 1.31 | 0x00000000 | Right gain scale BQ coefficient |
| Volume Alpha Filter | | | | | |
| 0x58 | 0x1A | Softening Filter Alpha | 4 / 1.31 | 0x00A7264A | Volume time constant |
| DRC 1 | | | | | |
| 0x6C | 0x1A | DRC1 Energy | 4 / 1.31 | 0x7FFFFFFF | DRC1 Energy Time constant |
| 0x70 | 0x1A | DRC1 Attack | 4 / 1.31 | 0x7FFFFFFF | DRC1 Attack Time constant |
| 0x74 | 0x1A | DRC1 Decay | 4 / 1.31 | 0x7FFFFFFF | DRC1 Decay Time constant |
| 0x78 | 0x1A | K0_1 | 4 / 9.23 | 0x00000000 | DRC1 Region 1 Slope (comp/Exp) |
| 0x7C | 0x1A | K1_1 | 4 / 9.23 | 0x00000000 | DRC1 Region 2 Slope (comp/Exp) |
| 0x08 | 0x1B | K2_1 | 4 / 9.23 | 0x00000000 | DRC1 Region 3 Slope (comp/Exp) |
| 0x0C | 0x1B | T1_1 | 4 / 9.23 | 0xE7000000 | DRC1 Threshold 1 |
| 0x10 | 0x1B | T2_1 | 4 / 9.23 | 0xFE800000 | DRC1 Threshold 2 |
| 0x14 | 0x1B | off1_1 | 4 / 9.23 | 0x00000000 | DRC1 Offset 1 |
| 0x18 | 0x1B | off2_1 | 4 / 9.23 | 0x00000000 | DRC1 Offset 2 |
| DRC 2 | | | | | |
| 0x1C | 0x1B | DRC2 Energy | 4 / 1.31 | 0x7FFFFFFF | DRC2 Energy Time constant |
| 0x20 | 0x1B | DRC2 Attack | 4 / 1.31 | 0x7FFFFFFF | DRC2 Attack Time constant |
| 0x24 | 0x1B | DRC2 Decay | 4 / 1.31 | 0x7FFFFFFF | DRC2 Decay Time constant |
| 0x28 | 0x1B | k0_2 | 4 / 9.23 | 0x00000000 | DRC2 Region 1 Slope (comp/Exp) |
| 0x2C | 0x1B | k1_2 | 4 / 9.23 | 0x00000000 | DRC2 Region 2 Slope (comp/Exp) |
| 0x30 | 0x1B | k2_2 | 4 / 9.23 | 0x00000000 | DRC2 Region 3 Slope (comp/Exp) |
| 0x34 | 0x1B | t1_2 | 4 / 9.23 | 0xE7000000 | DRC2 Threshold 1 |
| 0x38 | 0x1B | t2_2 | 4 / 9.23 | 0xFE800000 | DRC2 Threshold 2 |
| 0x3C | 0x1B | off1_2 | 4 / 9.23 | 0x00000000 | DRC2 Offset 1 |
| 0x40 | 0x1B | off2_2 | 4 / 9.23 | 0x00000000 | DRC2 Offset 2 |
| DRC 3 | | | | | |
| 0x44 | 0x1B | DRC3 Energy | 4 / 1.31 | 0x7FFFFFFF | DRC3 Energy Time constant |
| 0x48 | 0x1B | DRC3 Attack | 4 / 1.31 | 0x7FFFFFFF | DRC3 Attack Time constant |
| 0x4C | 0x1B | DRC3 Decay | 4 / 1.31 | 0x7FFFFFFF | DRC3 Decay Time constant |
| 0x50 | 0x1B | k0_3 | 4 / 9.23 | 0x00000000 | DRC3 Region 1 Slope (comp/Exp) |
| 0x54 | 0x1B | k1_3 | 4 / 9.23 | 0x00000000 | DRC3 Region 2 Slope (comp/Exp) |
| 0x58 | 0x1B | k1_3 | 4 / 9.23 | 0x00000000 | DRC3 Region 3 Slope (comp/Exp) |
| 0x5C | 0x1B | t1_3 | 4 / 9.23 | 0xE7000000 | DRC3 Threshold 1 |
| 0x60 | 0x1B | t2_3 | 4 / 9.23 | 0xFE800000 | DRC3 Threshold 2 |
| 0x64 | 0x1B | off1_3 | 4 / 9.23 | 0x00000000 | DRC3 Offset 1 |
| 0x68 | 0x1B | off2_3 | 4 / 9.23 | 0x00000000 | DRC3 Offset 2 |
| THD Clipper | | | | | |
| 0x2C | 0x1D | CH-LR THD Boost | 4 / 9.23 | 0x00800000 | THD LR Channel pre-scale coefficient |
| 0x34 | 0x1D | CH-L Fine Volume | 4 / 2.30 | 0x3FFFFFFF | THD L Channel post-scale coefficient |
| 0x38 | 0x1D | CH-R Fine Volume | 4 / 2.30 | 0x3FFFFFFF | THD R Channel post-scale coefficient |
| DRC Mixer Gain | | | | | |
| 0x40 | 0x1D | DRC 1 Mixer Gain | 4 / 9.23 | 0x00800000 | DRC 1 Mixer Gain coefficient |
| 0x44 | 0x1D | DRC 2 Mixer Gain | 4 / 9.23 | 0x00000000 | DRC 2 Mixer Gain coefficient |
| 0x48 | 0x1D | DRC 3 Mixer Gain | 4 / 9.23 | 0x00000000 | DRC 3 Mixer Gain coefficient |

Table 7. DSP Memory Map for Process Flow 1 — Book 0x8C (continued)

| Sub Address | Page | Register Name | Number of Bytes/Format | Default Value | Description |
|-------------------------|------|--------------------------|------------------------|---------------|--------------------------------------|
| Input Mixer | | | | | |
| 0x5C | 0x1D | Left to Left | 4 / 9.23 | 0x00800000 | Left Channel Mixer Left Input Gain |
| 0x60 | 0x1D | Right to Left | 4 / 9.23 | 0x00000000 | Left Channel Mixer Right Input Gain |
| 0x64 | 0x1D | Left to Right | 4 / 9.23 | 0x00000000 | Right Channel Mixer Left Input Gain |
| 0x68 | 0x1D | Right to Right | 4 / 9.23 | 0x00800000 | Right Channel Mixer Right Input Gain |
| Output Cross Bar | | | | | |
| 0x14 | 0x1E | Digital Left from Left | 4 / 9.23 | 0x00800000 | I2S Left output gain from left |
| 0x18 | 0x1E | Digital Left from Right | 4 / 9.23 | 0x00000000 | I2S Left output gain from Right |
| 0x20 | 0x1E | Digital Right from Left | 4 / 9.23 | 0x00000000 | I2S Right output gain from left |
| 0x24 | 0x1E | Digital Right from Right | 4 / 9.23 | 0x00800000 | I2S Right output gain from Right |
| 0x2C | 0x1E | Analog Left from Left | 4 / 9.23 | 0x00800000 | Analog Left output gain from left |
| 0x30 | 0x1E | Analog Left from Right | 4 / 9.23 | 0x00000000 | Analog Left output gain from Right |
| 0x38 | 0x1E | Analog Right from Left | 4 / 9.23 | 0x00000000 | Analog Right output gain from left |
| 0x3C | 0x1E | Analog Right from Right | 4 / 9.23 | 0x00800000 | Analog Right output gain from Right |
| Volume Control | | | | | |
| 0x44 | 0x1E | CH-L Volume | 4 / 9.23 | 0x00800000 | Left Channel volume coefficient |
| 0x48 | 0x1E | CH-R Volume | 4 / 9.23 | 0x00800000 | Right Channel volume coefficient |
| AGL | | | | | |
| 0x14 | 0x1F | Attack Threshold | 4 / 1.31 | 0x40000000 | Threshold linear |
| 0x18 | 0x1F | Softening Filter Alpha | 4 / 1.31 | 0x06153BD1 | AGL Alpha Time constant |
| 0x1C | 0x1F | Attack Rate | 4 / 1.31 | 0x0001B4E8 | AGL Attack Time constant |
| 0x20 | 0x1F | AGL Enable | 4 / 1.31 | 0x40000000 | AGL Enable flag |
| 0x28 | 0x1F | Softening Filter Omega | 4 / 1.31 | 0x79EAC42F | AGL Omega Time constant |
| 0x2C | 0x1F | Release Rate | 4 / 1.31 | 0x00002BB1 | AGL Release Time constant |

A.2 DSP Memory Map for Process Flow 2

Table 8 lists the DSP memory map for process flow 2.

Table 8. DSP Memory Map for Process Flow 2 — Book 0x8C

| Sub Address | Page | Register Name | Number of Bytes/Format | Default Value | Description |
|-----------------------|------|----------------|------------------------|---------------|---------------------|
| EQ LEFT 11 BQs | | | | | |
| 0x1C | 0x16 | CH -L BQ 1 B0 | 4 / 1.31 | 0x7FFFFFFF | Left BQ coefficient |
| 0x20 | 0x16 | CH -L BQ 1 B1 | 4 / 2.30 | 0x00000000 | Left BQ coefficient |
| 0x24 | 0x16 | CH -L BQ 1 B2 | 4 / 1.31 | 0x00000000 | Left BQ coefficient |
| 0x28 | 0x16 | CH -L BQ 1 A1 | 4 / 2.30 | 0x00000000 | Left BQ coefficient |
| 0x2C | 0x16 | CH -L BQ 1 A2 | 4 / 1.31 | 0x00000000 | Left BQ coefficient |
| 0x30 | 0x16 | CH -L BQ 2 B0 | 4 / 1.31 | 0x7FFFFFFF | Left BQ coefficient |
| 0x34 | 0x16 | CH -L BQ 2 B1 | 4 / 2.30 | 0x00000000 | Left BQ coefficient |
| 0x38 | 0x16 | CH -L BQ 2 B2 | 4 / 1.31 | 0x00000000 | Left BQ coefficient |
| 0x3C | 0x16 | CH -L BQ 2 A1 | 4 / 2.30 | 0x00000000 | Left BQ coefficient |
| 0x40 | 0x16 | CH -L BQ 2 A2 | 4 / 1.31 | 0x00000000 | Left BQ coefficient |
| 0x44 | 0x16 | CH -L BQ 3 B0 | 4 / 1.31 | 0x7FFFFFFF | Left BQ coefficient |
| 0x48 | 0x16 | CH -L BQ 3 B1 | 4 / 2.30 | 0x00000000 | Left BQ coefficient |
| 0x4C | 0x16 | CH -L BQ 3 B2 | 4 / 1.31 | 0x00000000 | Left BQ coefficient |
| 0x50 | 0x16 | CH -L BQ 3 A1 | 4 / 2.30 | 0x00000000 | Left BQ coefficient |
| 0x54 | 0x16 | CH -L BQ 3 A2 | 4 / 1.31 | 0x00000000 | Left BQ coefficient |
| 0x58 | 0x16 | CH -L BQ 4 B0 | 4 / 1.31 | 0x7FFFFFFF | Left BQ coefficient |
| 0x5C | 0x16 | CH -L BQ 4 B1 | 4 / 2.30 | 0x00000000 | Left BQ coefficient |
| 0x60 | 0x16 | CH -L BQ 4 B2 | 4 / 1.31 | 0x00000000 | Left BQ coefficient |
| 0x64 | 0x16 | CH -L BQ 4 A1 | 4 / 2.30 | 0x00000000 | Left BQ coefficient |
| 0x68 | 0x16 | CH -L BQ 4 A2 | 4 / 1.31 | 0x00000000 | Left BQ coefficient |
| 0x6C | 0x16 | CH -L BQ 5 B0 | 4 / 1.31 | 0x7FFFFFFF | Left BQ coefficient |
| 0x70 | 0x16 | CH -L BQ 5 B1 | 4 / 2.30 | 0x00000000 | Left BQ coefficient |
| 0x74 | 0x16 | CH -L BQ 5 B2 | 4 / 1.31 | 0x00000000 | Left BQ coefficient |
| 0x78 | 0x16 | CH -L BQ 5 A1 | 4 / 2.30 | 0x00000000 | Left BQ coefficient |
| 0x7C | 0x16 | CH -L BQ 5 A2 | 4 / 1.31 | 0x00000000 | Left BQ coefficient |
| 0x08 | 0x17 | CH -L BQ 6 B0 | 4 / 1.31 | 0x7FFFFFFF | Left BQ coefficient |
| 0x0C | 0x17 | CH -L BQ 6 B1 | 4 / 2.30 | 0x00000000 | Left BQ coefficient |
| 0x10 | 0x17 | CH -L BQ 6 B2 | 4 / 1.31 | 0x00000000 | Left BQ coefficient |
| 0x14 | 0x17 | CH -L BQ 6 A1 | 4 / 2.30 | 0x00000000 | Left BQ coefficient |
| 0x18 | 0x17 | CH -LBQ 6 A2 | 4 / 1.31 | 0x00000000 | Left BQ coefficient |
| 0x1C | 0x17 | CH -L BQ 7 B0 | 4 / 1.31 | 0x7FFFFFFF | Left BQ coefficient |
| 0x20 | 0x17 | CH -L BQ 7 B1 | 4 / 2.30 | 0x00000000 | Left BQ coefficient |
| 0x24 | 0x17 | CH -L BQ 7 B2 | 4 / 1.31 | 0x00000000 | Left BQ coefficient |
| 0x28 | 0x17 | CH -L BQ 7 A1 | 4 / 2.30 | 0x00000000 | Left BQ coefficient |
| 0x2C | 0x17 | CH -L BQ 7 A2 | 4 / 1.31 | 0x00000000 | Left BQ coefficient |
| 0x30 | 0x17 | CH -L BQ 8 B0 | 4 / 1.31 | 0x7FFFFFFF | Left BQ coefficient |
| 0x34 | 0x17 | CH -L BQ 8 B1 | 4 / 2.30 | 0x00000000 | Left BQ coefficient |
| 0x38 | 0x17 | CH -L BQ 8 B2 | 4 / 1.31 | 0x00000000 | Left BQ coefficient |
| 0x3C | 0x17 | CH -L BQ 8 A1 | 4 / 2.30 | 0x00000000 | Left BQ coefficient |
| 0x40 | 0x17 | CH -L BQ 8 A2 | 4 / 1.31 | 0x00000000 | Left BQ coefficient |
| 0x44 | 0x17 | CH -L BQ 9 B0 | 4 / 1.31 | 0x7FFFFFFF | Left BQ coefficient |
| 0x48 | 0x17 | CH -L BQ 9 B1 | 4 / 2.30 | 0x00000000 | Left BQ coefficient |
| 0x4C | 0x17 | CH -L BQ 9 B2 | 4 / 1.31 | 0x00000000 | Left BQ coefficient |
| 0x50 | 0x17 | CH -L BQ 9 A1 | 4 / 2.30 | 0x00000000 | Left BQ coefficient |
| 0x54 | 0x17 | CH -L BQ 9 A2 | 4 / 1.31 | 0x00000000 | Left BQ coefficient |
| 0x58 | 0x17 | CH -L BQ 10 B0 | 4 / 1.31 | 0x7FFFFFFF | Left BQ coefficient |
| 0x5C | 0x17 | CH -L BQ 10 B1 | 4 / 2.30 | 0x00000000 | Left BQ coefficient |

Table 8. DSP Memory Map for Process Flow 2 — Book 0x8C (continued)

| Sub Address | Page | Register Name | Number of Bytes/Format | Default Value | Description |
|------------------------|------|----------------|------------------------|---------------|--------------------------------|
| 0x60 | 0x17 | CH -L BQ 10 B2 | 4 / 1.31 | 0x00000000 | Left BQ coefficient |
| 0x64 | 0x17 | CH -L BQ 10 A1 | 4 / 2.30 | 0x00000000 | Left BQ coefficient |
| 0x68 | 0x17 | CH -L BQ 10 A2 | 4 / 1.31 | 0x00000000 | Left BQ coefficient |
| 0x6C | 0x17 | CH -L BQ 11 B0 | 4 / 1.31 | 0x7FFFFFFF | Left BQ coefficient |
| 0x70 | 0x17 | CH -L BQ 11 B1 | 4 / 2.30 | 0x00000000 | Left BQ coefficient |
| 0x74 | 0x17 | CH -L BQ 11 B2 | 4 / 1.31 | 0x00000000 | Left BQ coefficient |
| 0x78 | 0x17 | CH -L BQ 11 A1 | 4 / 2.30 | 0x00000000 | Left BQ coefficient |
| 0x7C | 0x17 | CH -L BQ 11 A2 | 4 / 1.31 | 0x00000000 | Left BQ coefficient |
| LEFT INTGAIN BQ | | | | | |
| 0x08 | 0x18 | CH -L BQ 12 B0 | 4 / 5.27 | 0x08000000 | Left gain scale BQ coefficient |
| 0x0C | 0x18 | CH -L BQ 12 B1 | 4 / 6.26 | 0x00000000 | Left gain scale BQ coefficient |
| 0x10 | 0x18 | CH -L BQ 12 B2 | 4 / 5.27 | 0x00000000 | Left gain scale BQ coefficient |
| 0x14 | 0x18 | CH -L BQ 12 A1 | 4 / 2.30 | 0x00000000 | Left gain scale BQ coefficient |
| 0x18 | 0x18 | CH -L BQ 12 A2 | 4 / 1.31 | 0x00000000 | Left gain scale BQ coefficient |
| EQ RIGHT 11 BQs | | | | | |
| 0x58 | 0x18 | CH -R BQ 1 B0 | 4 / 1.31 | 0x7FFFFFFF | Right BQ coefficient |
| 0x5C | 0x18 | CH -R BQ 1 B1 | 4 / 2.30 | 0x00000000 | Right BQ coefficient |
| 0x60 | 0x18 | CH -R BQ 1 B2 | 4 / 1.31 | 0x00000000 | Right BQ coefficient |
| 0x64 | 0x18 | CH -R BQ 1 A1 | 4 / 2.30 | 0x00000000 | Right BQ coefficient |
| 0x68 | 0x18 | CH -R BQ 1 A2 | 4 / 1.31 | 0x00000000 | Right BQ coefficient |
| 0x6C | 0x18 | CH -R BQ 2 B0 | 4 / 1.31 | 0x7FFFFFFF | Right BQ coefficient |
| 0x70 | 0x18 | CH -R BQ 2 B1 | 4 / 2.30 | 0x00000000 | Right BQ coefficient |
| 0x74 | 0x18 | CH -R BQ 2 B2 | 4 / 1.31 | 0x00000000 | Right BQ coefficient |
| 0x78 | 0x18 | CH -R BQ 2 A1 | 4 / 2.30 | 0x00000000 | Right BQ coefficient |
| 0x7C | 0x18 | CH -R BQ 2 A2 | 4 / 1.31 | 0x00000000 | Right BQ coefficient |
| 0x08 | 0x19 | CH -R BQ 3 B0 | 4 / 1.31 | 0x7FFFFFFF | Right BQ coefficient |
| 0x0C | 0x19 | CH -R BQ 3 B1 | 4 / 2.30 | 0x00000000 | Right BQ coefficient |
| 0x10 | 0x19 | CH -R BQ 3 B2 | 4 / 1.31 | 0x00000000 | Right BQ coefficient |
| 0x14 | 0x19 | CH -R BQ 3 A1 | 4 / 2.30 | 0x00000000 | Right BQ coefficient |
| 0x18 | 0x19 | CH -R BQ 3 A2 | 4 / 1.31 | 0x00000000 | Right BQ coefficient |
| 0x1C | 0x19 | CH -R BQ 4 B0 | 4 / 1.31 | 0x7FFFFFFF | Right BQ coefficient |
| 0x20 | 0x19 | CH -R BQ 4 B1 | 4 / 2.30 | 0x00000000 | Right BQ coefficient |
| 0x24 | 0x19 | CH -R BQ 4 B2 | 4 / 1.31 | 0x00000000 | Right BQ coefficient |
| 0x28 | 0x19 | CH -R BQ 4 A1 | 4 / 2.30 | 0x00000000 | Right BQ coefficient |
| 0x2C | 0x19 | CH -R BQ 4 A2 | 4 / 1.31 | 0x00000000 | Right BQ coefficient |
| 0x30 | 0x19 | CH -R BQ 5 B0 | 4 / 1.31 | 0x7FFFFFFF | Right BQ coefficient |
| 0x34 | 0x19 | CH -R BQ 5 B1 | 4 / 2.30 | 0x00000000 | Right BQ coefficient |
| 0x38 | 0x19 | CH -R BQ 5 B2 | 4 / 1.31 | 0x00000000 | Right BQ coefficient |
| 0x3C | 0x19 | CH -R BQ 5 A1 | 4 / 2.30 | 0x00000000 | Right BQ coefficient |
| 0x40 | 0x19 | CH -R BQ 5 A2 | 4 / 1.31 | 0x00000000 | Right BQ coefficient |
| 0x44 | 0x19 | CH -R BQ 6 B0 | 4 / 1.31 | 0x7FFFFFFF | Right BQ coefficient |
| 0x48 | 0x19 | CH -R BQ 6 B1 | 4 / 2.30 | 0x00000000 | Right BQ coefficient |
| 0x4C | 0x19 | CH -R BQ 6 B2 | 4 / 1.31 | 0x00000000 | Right BQ coefficient |
| 0x50 | 0x19 | CH -R BQ 6 A1 | 4 / 2.30 | 0x00000000 | Right BQ coefficient |
| 0x54 | 0x19 | CH -R BQ 6 A2 | 4 / 1.31 | 0x00000000 | Right BQ coefficient |
| 0x58 | 0x19 | CH -R BQ 7 B0 | 4 / 1.31 | 0x7FFFFFFF | Right BQ coefficient |
| 0x5C | 0x19 | CH -R BQ 7 B1 | 4 / 2.30 | 0x00000000 | Right BQ coefficient |
| 0x60 | 0x19 | CH -R BQ 7 B2 | 4 / 1.31 | 0x00000000 | Right BQ coefficient |
| 0x64 | 0x19 | CH -R BQ 7 A1 | 4 / 2.30 | 0x00000000 | Right BQ coefficient |
| 0x68 | 0x19 | CH -R BQ 7 A2 | 4 / 1.31 | 0x00000000 | Right BQ coefficient |
| 0x6C | 0x19 | CH -R BQ 8 B0 | 4 / 1.31 | 0x7FFFFFFF | Right BQ coefficient |

Table 8. DSP Memory Map for Process Flow 2 — Book 0x8C (continued)

| Sub Address | Page | Register Name | Number of Bytes/Format | Default Value | Description |
|----------------------------|------|--------------------------|------------------------|---------------|--------------------------------------|
| 0x70 | 0x19 | CH -R BQ 8 B1 | 4 / 2.30 | 0x00000000 | Right BQ coefficient |
| 0x74 | 0x19 | CH -R BQ 8 B2 | 4 / 1.31 | 0x00000000 | Right BQ coefficient |
| 0x78 | 0x19 | CH -R BQ 8 A1 | 4 / 2.30 | 0x00000000 | Right BQ coefficient |
| 0x7C | 0x19 | CH -R BQ 8 A2 | 4 / 1.31 | 0x00000000 | Right BQ coefficient |
| 0x08 | 0x1A | CH -R BQ 9 B0 | 4 / 1.31 | 0x7FFFFFFF | Right BQ coefficient |
| 0x0C | 0x1A | CH -R BQ 9 B1 | 4 / 2.30 | 0x00000000 | Right BQ coefficient |
| 0x10 | 0x1A | CH -R BQ 9 B2 | 4 / 1.31 | 0x00000000 | Right BQ coefficient |
| 0x14 | 0x1A | CH -R BQ 9 A1 | 4 / 2.30 | 0x00000000 | Right BQ coefficient |
| 0x18 | 0x1A | CH -R BQ 9 A2 | 4 / 1.31 | 0x00000000 | Right BQ coefficient |
| 0x1C | 0x1A | CH -R BQ 10 B0 | 4 / 1.31 | 0x7FFFFFFF | Right BQ coefficient |
| 0x20 | 0x1A | CH -R BQ 10 B1 | 4 / 2.30 | 0x00000000 | Right BQ coefficient |
| 0x24 | 0x1A | CH -R BQ 10 B2 | 4 / 1.31 | 0x00000000 | Right BQ coefficient |
| 0x28 | 0x1A | CH -R BQ 10 A1 | 4 / 2.30 | 0x00000000 | Right BQ coefficient |
| 0x2C | 0x1A | CH -R BQ 10 A2 | 4 / 1.31 | 0x00000000 | Right BQ coefficient |
| 0x30 | 0x1A | CH -R BQ 11 B0 | 4 / 1.31 | 0x7FFFFFFF | Right BQ coefficient |
| 0x34 | 0x1A | CH -R BQ 11 B1 | 4 / 2.30 | 0x00000000 | Right BQ coefficient |
| 0x38 | 0x1A | CH -R BQ 11 B2 | 4 / 1.31 | 0x00000000 | Right BQ coefficient |
| 0x3C | 0x1A | CH -R BQ 11 A1 | 4 / 2.30 | 0x00000000 | Right BQ coefficient |
| 0x40 | 0x1A | CH -R BQ 11 A2 | 4 / 1.31 | 0x00000000 | Right BQ coefficient |
| RIGHT INTGAIN BQ | | | | | |
| 0x44 | 0x1A | CH -R BQ 12 B0 | 4 / 5.27 | 0x08000000 | Right gain scale BQ coefficient |
| 0x48 | 0x1A | CH -R BQ 12 B1 | 4 / 6.26 | 0x00000000 | Right gain scale BQ coefficient |
| 0x4C | 0x1A | CH -R BQ 12 B2 | 4 / 5.27 | 0x00000000 | Right gain scale BQ coefficient |
| 0x50 | 0x1A | CH -R BQ 12 A1 | 4 / 2.30 | 0x00000000 | Right gain scale BQ coefficient |
| 0x54 | 0x1A | CH -R BQ 12 A2 | 4 / 1.31 | 0x00000000 | Right gain scale BQ coefficient |
| VOLUME ALPHA FILTER | | | | | |
| 0x58 | 0x1A | Softening Filter Alpha | 4 / 1.31 | 0x00A7264A | Volume time constant |
| THD CLIPPER | | | | | |
| 0x2C | 0x1D | CH-LR THD Boost | 4 / 9.23 | 0x00800000 | THD LR Channel pre-scale coefficient |
| 0x34 | 0x1D | CH-L Fine Volume | 4 / 2.30 | 0x3FFFFFFF | THD L Channel post-scale coefficient |
| 0x38 | 0x1D | CH-R Fine Volume | 4 / 2.30 | 0x3FFFFFFF | THD R Channel post-scale coefficient |
| INPUT MIXER | | | | | |
| 0x5C | 0x1D | Left to Left | 4 / 9.23 | 0x00800000 | Left Channel Mixer Left Input Gain |
| 0x60 | 0x1D | Right to Left | 4 / 9.23 | 0x00000000 | Left Channel Mixer Right Input Gain |
| 0x64 | 0x1D | Left to Right | 4 / 9.23 | 0x00000000 | Right Channel Mixer Left Input Gain |
| 0x68 | 0x1D | Right to Right | 4 / 9.23 | 0x00800000 | Right Channel Mixer Right Input Gain |
| OUTPUT CROSS BAR | | | | | |
| 0x14 | 0x1E | Digital Left from Left | 4 / 9.23 | 0x00800000 | I2S Left output gain from left |
| 0x18 | 0x1E | Digital Left from Right | 4 / 9.23 | 0x00000000 | I2S Left output gain from Right |
| 0x20 | 0x1E | Digital Right from Left | 4 / 9.23 | 0x00000000 | I2S Right output gain from left |
| 0x24 | 0x1E | Digital Right from Right | 4 / 9.23 | 0x00800000 | I2S Right output gain from Right |
| 0x2C | 0x1E | Analog Left from Left | 4 / 9.23 | 0x00800000 | Analog Left output gain from left |
| 0x30 | 0x1E | Analog Left from Right | 4 / 9.23 | 0x00000000 | Analog Left output gain from Right |
| 0x38 | 0x1E | Analog Right from Left | 4 / 9.23 | 0x00000000 | Analog Right output gain from left |
| 0x3C | 0x1E | Analog Right from Right | 4 / 9.23 | 0x00800000 | Analog Right output gain from Right |
| VOLUME CONTROL | | | | | |
| 0x44 | 0x1E | CH-L Volume | 4 / 9.23 | 0x00800000 | Left Channel volume coefficient |
| 0x48 | 0x1E | CH-R Volume | 4 / 9.23 | 0x00800000 | Right Channel volume coefficient |

Table 8. DSP Memory Map for Process Flow 2 — Book 0x8C (continued)

| Sub Address | Page | Register Name | Number of Bytes/Format | Default Value | Description |
|-------------------------------|------|-----------------|------------------------|---------------|------------------------------------|
| THERMAL PROTECT ENERGY | | | | | |
| 0x34 | 0x1F | Thermal | 4 / - | 0x00A7264A | Generated by GUI |
| MORPHING CONTROL | | | | | |
| 0x38 | 0x1F | CH-L Gain scale | 4 / 9.23 | 0x00800000 | Morphing Left Channel Gain |
| 0x3C | 0x1F | CH-R Gain scale | 4 / 9.23 | 0x00800000 | Morphing Right Channel Gain |
| 0x40 | 0x1F | Morphing Energy | 4 / 1.31 | 0x001C7019 | Morphing Energy Time constant |
| 0x44 | 0x1F | Morphing Attack | 4 / 1.31 | 0x0012F61A | Morphing Attack Time constant |
| 0x48 | 0x1F | Morphing Decay | 4 / 1.31 | 0x00065258 | Morphing Decay Time constant |
| 0x4C | 0x1F | Morphing K0_1 | 4 / 9.23 | 0x00000000 | Morphing Region 1 Slope (comp/Exp) |
| 0x50 | 0x1F | Morphing K1_1 | 4 / 9.23 | 0x00000000 | Morphing Region 2 Slope (comp/Exp) |
| 0x54 | 0x1F | Morphing K2_1 | 4 / 9.23 | 0x00000000 | Morphing Region 3 Slope (comp/Exp) |
| 0x58 | 0x1F | Morphing T1_1 | 4 / 9.23 | 0xF75C28F6 | Morphing Threshold 1 |
| 0x5C | 0x1F | Morphing T2_1 | 4 / 9.23 | 0xFCC2D8C5 | Morphing Threshold 2 |
| 0x60 | 0x1F | Morphing off1_1 | 4 / 9.23 | 0x00000000 | Morphing Offset 1 |
| 0x64 | 0x1F | Morphing off2_1 | 4 / 9.23 | 0x00000000 | Morphing Offset 2 |
| EXCURSION | | | | | |
| 0x68 | 0x1F | Excursion | 4 / - | 0x00000000 | Generated by GUI |
| 0x6C | 0x1F | Excursion | 4 / - | 0x00000000 | Generated by GUI |
| 0x70 | 0x1F | Excursion | 4 / - | 0x00000000 | Generated by GUI |
| 0x74 | 0x1F | Excursion | 4 / - | 0x00000000 | Generated by GUI |
| 0x78 | 0x1F | Excursion | 4 / - | 0x00000000 | Generated by GUI |
| 0x7C | 0x1F | Excursion | 4 / - | 0x00000000 | Generated by GUI |
| 0x08 | 0x20 | Excursion | 4 / - | 0x00000000 | Generated by GUI |
| 0x0C | 0x20 | Excursion | 4 / - | 0x00000000 | Generated by GUI |
| 0x10 | 0x20 | Excursion | 4 / - | 0x00000000 | Generated by GUI |
| 0x14 | 0x20 | Excursion | 4 / - | 0x00000000 | Generated by GUI |
| 0x18 | 0x20 | Excursion | 4 / - | 0x00000000 | Generated by GUI |
| 0x1C | 0x20 | Excursion | 4 / - | 0x00000000 | Generated by GUI |
| 0x20 | 0x20 | Excursion | 4 / - | 0x00000000 | Generated by GUI |
| 0x24 | 0x20 | Excursion | 4 / - | 0x00000000 | Generated by GUI |
| 0x28 | 0x20 | Excursion | 4 / - | 0x00000000 | Generated by GUI |
| 0x2C | 0x20 | Excursion | 4 / - | 0x00000000 | Generated by GUI |
| 0x30 | 0x20 | Excursion | 4 / - | 0x00000000 | Generated by GUI |
| 0x34 | 0x20 | Excursion | 4 / - | 0x00000000 | Generated by GUI |
| 0x38 | 0x20 | Excursion | 4 / - | 0x00000000 | Generated by GUI |
| 0x3C | 0x20 | Excursion | 4 / - | 0x00000000 | Generated by GUI |
| 0x40 | 0x20 | Excursion | 4 / - | 0x00000000 | Generated by GUI |
| 0x44 | 0x20 | Excursion | 4 / - | 0x00000000 | Generated by GUI |
| 0x48 | 0x20 | Excursion | 4 / - | 0x00000000 | Generated by GUI |
| 0x4C | 0x20 | Excursion | 4 / - | 0x00000000 | Generated by GUI |
| 0x50 | 0x20 | Excursion | 4 / - | 0x00000000 | Generated by GUI |
| 0x54 | 0x20 | Excursion | 4 / - | 0x00000000 | Generated by GUI |
| 0x58 | 0x20 | Excursion | 4 / - | 0x00000000 | Generated by GUI |
| 0x5C | 0x20 | Excursion | 4 / - | 0x00000000 | Generated by GUI |
| 0x60 | 0x20 | Excursion | 4 / - | 0x00000000 | Generated by GUI |
| 0x64 | 0x20 | Excursion | 4 / - | 0x00000000 | Generated by GUI |
| 0x68 | 0x20 | Excursion | 4 / - | 0x7FFFFFFF | Generated by GUI |
| 0x6C | 0x20 | Excursion | 4 / - | 0x00000000 | Generated by GUI |
| 0x70 | 0x20 | Excursion | 4 / - | 0x00000000 | Generated by GUI |
| 0x74 | 0x20 | Excursion | 4 / - | 0x00000000 | Generated by GUI |
| 0x78 | 0x20 | Excursion | 4 / - | 0x00000000 | Generated by GUI |

Table 8. DSP Memory Map for Process Flow 2 — Book 0x8C (continued)

| Sub Address | Page | Register Name | Number of Bytes/Format | Default Value | Description |
|----------------------------------|------|---------------|------------------------|---------------|---------------------------------------|
| 0x7C | 0x20 | Excursion | 4 / - | 0x7FFFFFFF | Generated by GUI |
| 0x08 | 0x21 | Excursion | 4 / - | 0x00000000 | Generated by GUI |
| 0x0C | 0x21 | Excursion | 4 / - | 0x00000000 | Generated by GUI |
| 0x10 | 0x21 | Excursion | 4 / - | 0x00000000 | Generated by GUI |
| 0x14 | 0x21 | Excursion | 4 / - | 0x00000000 | Generated by GUI |
| 0x18 | 0x21 | Excursion | 4 / - | 0x7FFFFFFF | Generated by GUI |
| 0x1C | 0x21 | Excursion | 4 / - | 0xFF18B74D | Generated by GUI |
| 0x20 | 0x21 | Excursion | 4 / - | 0x00800000 | Generated by GUI |
| MORPHING BQs | | | | | |
| 0x24 | 0x21 | CH-L BQ 1 B0 | 4 / 1.31 | 0x7FFFFFFF | Left Channel Morphing BQ coefficient |
| 0x28 | 0x21 | CH-L BQ 1 B1 | 4 / 2.30 | 0x00000000 | Left Channel Morphing BQ coefficient |
| 0x2C | 0x21 | CH-L BQ 1 B2 | 4 / 1.31 | 0x00000000 | Left Channel Morphing BQ coefficient |
| 0x30 | 0x21 | CH-L BQ 1 A1 | 4 / 2.30 | 0x00000000 | Left Channel Morphing BQ coefficient |
| 0x34 | 0x21 | CH-L BQ 1 A2 | 4 / 1.31 | 0x00000000 | Left Channel Morphing BQ coefficient |
| 0x38 | 0x21 | CH-L BQ 2 B0 | 4 / 1.31 | 0x7FFFFFFF | Left Channel Morphing BQ coefficient |
| 0x3C | 0x21 | CH-L BQ 2 B1 | 4 / 2.30 | 0x00000000 | Left Channel Morphing BQ coefficient |
| 0x40 | 0x21 | CH-L BQ 2 B2 | 4 / 1.31 | 0x00000000 | Left Channel Morphing BQ coefficient |
| 0x44 | 0x21 | CH-L BQ 2 A1 | 4 / 2.30 | 0x00000000 | Left Channel Morphing BQ coefficient |
| 0x48 | 0x21 | CH-L BQ 2 A2 | 4 / 1.31 | 0x00000000 | Left Channel Morphing BQ coefficient |
| 0x4C | 0x21 | CH-R BQ 1 B0 | 4 / 1.31 | 0x7FFFFFFF | Right Channel Morphing BQ coefficient |
| 0x50 | 0x21 | CH-R BQ 1 B1 | 4 / 2.30 | 0x00000000 | Right Channel Morphing BQ coefficient |
| 0x54 | 0x21 | CH-R BQ 1 B2 | 4 / 1.31 | 0x00000000 | Right Channel Morphing BQ coefficient |
| 0x58 | 0x21 | CH-R BQ 1 A1 | 4 / 2.30 | 0x00000000 | Right Channel Morphing BQ coefficient |
| 0x5C | 0x21 | CH-R BQ 1 A2 | 4 / 1.31 | 0x00000000 | Right Channel Morphing BQ coefficient |
| 0x60 | 0x21 | CH-R BQ 2 B0 | 4 / 1.31 | 0x7FFFFFFF | Right Channel Morphing BQ coefficient |
| 0x64 | 0x21 | CH-R BQ 2 B1 | 4 / 2.30 | 0x00000000 | Right Channel Morphing BQ coefficient |
| 0x68 | 0x21 | CH-R BQ 2 B2 | 4 / 1.31 | 0x00000000 | Right Channel Morphing BQ coefficient |
| 0x6C | 0x21 | CH-R BQ 2 A1 | 4 / 2.30 | 0x00000000 | Right Channel Morphing BQ coefficient |
| 0x70 | 0x21 | CH-R BQ 2 A2 | 4 / 1.31 | 0x00000000 | Right Channel Morphing BQ coefficient |
| THERMAL PROTECT THRESHOLD | | | | | |
| 0x74 | 0x21 | Thermal | 4 / - | 0x7FFFFFFF | Generated by GUI |

A.3 DSP Memory Map for Process Flow 3

Table 9 lists the DSP memory map for process flow 3.

Table 9. DSP Memory Map for Process Flow 3 — Book 0x8C

| Sub Address | Page | Register Name | Number of Bytes/Format | Default Value | Description |
|-------------------------------|------|----------------|------------------------|---------------|-----------------------------|
| BASS MONO MIXER | | | | | |
| 0x58 | 0x11 | BQ 1 B0 | 4 / 1.31 | 0x7FFFFFFF | Main Channel BQ coefficient |
| 0x5C | 0x11 | BQ 1 B1 | 4 / 2.30 | 0x00000000 | Main Channel BQ coefficient |
| 0x60 | 0x11 | BQ 1 B2 | 4 / 1.31 | 0x00000000 | Main Channel BQ coefficient |
| 0x64 | 0x11 | BQ 1 A1 | 4 / 2.30 | 0x00000000 | Main Channel BQ coefficient |
| 0x68 | 0x11 | BQ 1 A2 | 4 / 1.31 | 0x00000000 | Main Channel BQ coefficient |
| 0x44 | 0x12 | CH-Sub BQ 1 B0 | 4 / 1.31 | 0x7FFFFFFF | Sub Channel BQ coefficient |
| 0x48 | 0x12 | CH-Sub BQ 1 B1 | 4 / 2.30 | 0x00000000 | Sub Channel BQ coefficient |
| 0x4C | 0x12 | CH-Sub BQ 1 B2 | 4 / 1.31 | 0x00000000 | Sub Channel BQ coefficient |
| 0x50 | 0x12 | CH-Sub BQ 1 A1 | 4 / 2.30 | 0x00000000 | Sub Channel BQ coefficient |
| 0x54 | 0x12 | CH-Sub BQ 1 A2 | 4 / 1.31 | 0x00000000 | Sub Channel BQ coefficient |
| DRC 1 BQ | | | | | |
| 0x30 | 0x13 | BQ B0 | 4 / 1.31 | 0x7FFFFFFF | DRC 1 BQ coefficient |
| 0x34 | 0x13 | BQ B1 | 4 / 2.30 | 0x00000000 | DRC 1 BQ coefficient |
| 0x38 | 0x13 | BQ B2 | 4 / 1.31 | 0x00000000 | DRC 1 BQ coefficient |
| 0x3C | 0x13 | BQ A1 | 4 / 2.30 | 0x00000000 | DRC 1 BQ coefficient |
| 0x40 | 0x13 | BQ A2 | 4 / 1.31 | 0x00000000 | DRC 1 BQ coefficient |
| DRC 3 BQ | | | | | |
| 0x58 | 0x13 | BQ B0 | 4 / 1.31 | 0x7FFFFFFF | DRC 3 BQ coefficient |
| 0x5C | 0x13 | BQ B1 | 4 / 2.30 | 0x00000000 | DRC 3 BQ coefficient |
| 0x60 | 0x13 | BQ B2 | 4 / 1.31 | 0x00000000 | DRC 3 BQ coefficient |
| 0x64 | 0x13 | BQ A1 | 4 / 2.30 | 0x00000000 | DRC 3 BQ coefficient |
| 0x68 | 0x13 | BQ A2 | 4 / 1.31 | 0x00000000 | DRC 3 BQ coefficient |
| DRC 2 BQ | | | | | |
| 0x08 | 0x14 | BQ 1 B0 | 4 / 1.31 | 0x7FFFFFFF | DRC 2 BQ coefficient |
| 0x0C | 0x14 | BQ 1 B1 | 4 / 2.30 | 0x00000000 | DRC 2 BQ coefficient |
| 0x10 | 0x14 | BQ 1 B2 | 4 / 1.31 | 0x00000000 | DRC 2 BQ coefficient |
| 0x14 | 0x14 | BQ 1 A1 | 4 / 2.30 | 0x00000000 | DRC 2 BQ coefficient |
| 0x18 | 0x14 | BQ 1 A2 | 4 / 1.31 | 0x00000000 | DRC 2 BQ coefficient |
| 0x1C | 0x14 | BQ 2 B0 | 4 / 1.31 | 0x7FFFFFFF | DRC 2 BQ coefficient |
| 0x20 | 0x14 | BQ 2 B1 | 4 / 2.30 | 0x00000000 | DRC 2 BQ coefficient |
| 0x24 | 0x14 | BQ 2 B2 | 4 / 1.31 | 0x00000000 | DRC 2 BQ coefficient |
| 0x28 | 0x14 | BQ 2 A1 | 4 / 2.30 | 0x00000000 | DRC 2 BQ coefficient |
| 0x2C | 0x14 | BQ 2 A2 | 4 / 1.31 | 0x00000000 | DRC 2 BQ coefficient |
| DPEQ SENSE BQ | | | | | |
| 0x58 | 0x14 | BQ 1 B0 | 4 / 1.31 | 0x7FFFFFFF | DPEQ sense BQ coefficient |
| 0x5C | 0x14 | BQ 1 B1 | 4 / 2.30 | 0x00000000 | DPEQ sense BQ coefficient |
| 0x60 | 0x14 | BQ 1 B2 | 4 / 1.31 | 0x00000000 | DPEQ sense BQ coefficient |
| 0x64 | 0x14 | BQ 1 A1 | 4 / 2.30 | 0x00000000 | DPEQ sense BQ coefficient |
| 0x68 | 0x14 | BQ 1 A2 | 4 / 1.31 | 0x00000000 | DPEQ sense BQ coefficient |
| 0x6C | 0x14 | BQ 2 B0 | 4 / 1.31 | 0x7FFFFFFF | DPEQ sense BQ coefficient |
| 0x70 | 0x14 | BQ 2 B1 | 4 / 2.30 | 0x00000000 | DPEQ sense BQ coefficient |
| 0x74 | 0x14 | BQ 2 B2 | 4 / 1.31 | 0x00000000 | DPEQ sense BQ coefficient |
| 0x78 | 0x14 | BQ 2 A1 | 4 / 2.30 | 0x00000000 | DPEQ sense BQ coefficient |
| 0x7C | 0x14 | BQ 2 A2 | 4 / 1.31 | 0x00000000 | DPEQ sense BQ coefficient |
| DPEQ LOW LEVEL PATH BQ | | | | | |
| 0x08 | 0x15 | BQ 1 B0 | 4 / 1.31 | 0x7FFFFFFF | DPEQ low BQ coefficient |
| 0x0C | 0x15 | BQ 1 B1 | 4 / 2.30 | 0x00000000 | DPEQ low BQ coefficient |

Table 9. DSP Memory Map for Process Flow 3 — Book 0x8C (continued)

| Sub Address | Page | Register Name | Number of Bytes/Format | Default Value | Description |
|--------------------------------|------|---------------|------------------------|---------------|--------------------------|
| 0x10 | 0x15 | BQ 1 B2 | 4 / 1.31 | 0x00000000 | DPEQ low BQ coefficient |
| 0x14 | 0x15 | BQ 1 A1 | 4 / 2.30 | 0x00000000 | DPEQ low BQ coefficient |
| 0x18 | 0x15 | BQ 1 A2 | 4 / 1.31 | 0x00000000 | DPEQ low BQ coefficient |
| 0x1C | 0x15 | BQ 2 B0 | 4 / 1.31 | 0x7FFFFFFF | DPEQ low BQ coefficient |
| 0x20 | 0x15 | BQ 2 B1 | 4 / 2.30 | 0x00000000 | DPEQ low BQ coefficient |
| 0x24 | 0x15 | BQ 2 B2 | 4 / 1.31 | 0x00000000 | DPEQ low BQ coefficient |
| 0x28 | 0x15 | BQ 2 A1 | 4 / 2.30 | 0x00000000 | DPEQ low BQ coefficient |
| 0x2C | 0x15 | BQ 2 A2 | 4 / 1.31 | 0x00000000 | DPEQ low BQ coefficient |
| DPEQ HIGH LEVEL PATH BQ | | | | | |
| 0x30 | 0x15 | BQ 1 B0 | 4 / 1.31 | 0x7FFFFFFF | DPEQ high BQ coefficient |
| 0x34 | 0x15 | BQ 1 B1 | 4 / 2.30 | 0x00000000 | DPEQ high BQ coefficient |
| 0x38 | 0x15 | BQ 1 B2 | 4 / 1.31 | 0x00000000 | DPEQ high BQ coefficient |
| 0x3C | 0x15 | BQ 1 A1 | 4 / 2.30 | 0x00000000 | DPEQ high BQ coefficient |
| 0x40 | 0x15 | BQ 1 A2 | 4 / 1.31 | 0x00000000 | DPEQ high BQ coefficient |
| 0x44 | 0x15 | BQ 2 B0 | 4 / 1.31 | 0x7FFFFFFF | DPEQ high BQ coefficient |
| 0x48 | 0x15 | BQ 2 B1 | 4 / 2.30 | 0x00000000 | DPEQ high BQ coefficient |
| 0x4C | 0x15 | BQ 2 B2 | 4 / 1.31 | 0x00000000 | DPEQ high BQ coefficient |
| 0x50 | 0x15 | BQ 2 A1 | 4 / 2.30 | 0x00000000 | DPEQ high BQ coefficient |
| 0x54 | 0x15 | BQ 2 A2 | 4 / 1.31 | 0x00000000 | DPEQ high BQ coefficient |
| EQ LEFT 14 BQs | | | | | |
| 0x58 | 0x15 | CH -L BQ 1 B0 | 4 / 1.31 | 0x7FFFFFFF | Left BQ coefficient |
| 0x5C | 0x15 | CH -L BQ 1 B1 | 4 / 2.30 | 0x00000000 | Left BQ coefficient |
| 0x60 | 0x15 | CH -L BQ 1 B2 | 4 / 1.31 | 0x00000000 | Left BQ coefficient |
| 0x64 | 0x15 | CH -L BQ 1 A1 | 4 / 2.30 | 0x00000000 | Left BQ coefficient |
| 0x68 | 0x15 | CH -L BQ 1 A2 | 4 / 1.31 | 0x00000000 | Left BQ coefficient |
| 0x6C | 0x15 | CH -L BQ 2 B0 | 4 / 1.31 | 0x7FFFFFFF | Left BQ coefficient |
| 0x70 | 0x15 | CH -L BQ 2 B1 | 4 / 2.30 | 0x00000000 | Left BQ coefficient |
| 0x74 | 0x15 | CH -L BQ 2 B2 | 4 / 1.31 | 0x00000000 | Left BQ coefficient |
| 0x78 | 0x15 | CH -L BQ 2 A1 | 4 / 2.30 | 0x00000000 | Left BQ coefficient |
| 0x7C | 0x15 | CH -L BQ 2 A2 | 4 / 1.31 | 0x00000000 | Left BQ coefficient |
| 0x08 | 0x16 | CH -L BQ 3 B0 | 4 / 1.31 | 0x7FFFFFFF | Left BQ coefficient |
| 0x0C | 0x16 | CH -L BQ 3 B1 | 4 / 2.30 | 0x00000000 | Left BQ coefficient |
| 0x10 | 0x16 | CH -L BQ 3 B2 | 4 / 1.31 | 0x00000000 | Left BQ coefficient |
| 0x14 | 0x16 | CH -L BQ 3 A1 | 4 / 2.30 | 0x00000000 | Left BQ coefficient |
| 0x18 | 0x16 | CH -L BQ 3 A2 | 4 / 1.31 | 0x00000000 | Left BQ coefficient |
| 0x1C | 0x16 | CH -L BQ 4 B0 | 4 / 1.31 | 0x7FFFFFFF | Left BQ coefficient |
| 0x20 | 0x16 | CH -L BQ 4 B1 | 4 / 2.30 | 0x00000000 | Left BQ coefficient |
| 0x24 | 0x16 | CH -L BQ 4 B2 | 4 / 1.31 | 0x00000000 | Left BQ coefficient |
| 0x28 | 0x16 | CH -L BQ 4 A1 | 4 / 2.30 | 0x00000000 | Left BQ coefficient |
| 0x2C | 0x16 | CH -L BQ 4 A2 | 4 / 1.31 | 0x00000000 | Left BQ coefficient |
| 0x30 | 0x16 | CH -L BQ 5 B0 | 4 / 1.31 | 0x7FFFFFFF | Left BQ coefficient |
| 0x34 | 0x16 | CH -L BQ 5 B1 | 4 / 2.30 | 0x00000000 | Left BQ coefficient |
| 0x38 | 0x16 | CH -L BQ 5 B2 | 4 / 1.31 | 0x00000000 | Left BQ coefficient |
| 0x3C | 0x16 | CH -L BQ 5 A1 | 4 / 2.30 | 0x00000000 | Left BQ coefficient |
| 0x40 | 0x16 | CH -L BQ 5 A2 | 4 / 1.31 | 0x00000000 | Left BQ coefficient |
| 0x44 | 0x16 | CH -L BQ 6 B0 | 4 / 1.31 | 0x7FFFFFFF | Left BQ coefficient |
| 0x48 | 0x16 | CH -L BQ 6 B1 | 4 / 2.30 | 0x00000000 | Left BQ coefficient |
| 0x4C | 0x16 | CH -L BQ 6 B2 | 4 / 1.31 | 0x00000000 | Left BQ coefficient |
| 0x50 | 0x16 | CH -L BQ 6 A1 | 4 / 2.30 | 0x00000000 | Left BQ coefficient |
| 0x54 | 0x16 | CH -LBQ 6 A2 | 4 / 1.31 | 0x00000000 | Left BQ coefficient |
| 0x58 | 0x16 | CH -L BQ 7 B0 | 4 / 1.31 | 0x7FFFFFFF | Left BQ coefficient |

Table 9. DSP Memory Map for Process Flow 3 — Book 0x8C (continued)

| Sub Address | Page | Register Name | Number of Bytes/Format | Default Value | Description |
|------------------------|------|----------------|------------------------|---------------|--------------------------------|
| 0x5C | 0x16 | CH -L BQ 7 B1 | 4 / 2.30 | 0x00000000 | Left BQ coefficient |
| 0x60 | 0x16 | CH -L BQ 7 B2 | 4 / 1.31 | 0x00000000 | Left BQ coefficient |
| 0x64 | 0x16 | CH -L BQ 7 A1 | 4 / 2.30 | 0x00000000 | Left BQ coefficient |
| 0x68 | 0x16 | CH -L BQ 7 A2 | 4 / 1.31 | 0x00000000 | Left BQ coefficient |
| 0x6C | 0x16 | CH -L BQ 8 B0 | 4 / 1.31 | 0x7FFFFFFF | Left BQ coefficient |
| 0x70 | 0x16 | CH -L BQ 8 B1 | 4 / 2.30 | 0x00000000 | Left BQ coefficient |
| 0x74 | 0x16 | CH -L BQ 8 B2 | 4 / 1.31 | 0x00000000 | Left BQ coefficient |
| 0x78 | 0x16 | CH -L BQ 8 A1 | 4 / 2.30 | 0x00000000 | Left BQ coefficient |
| 0x7C | 0x16 | CH -L BQ 8 A2 | 4 / 1.31 | 0x00000000 | Left BQ coefficient |
| 0x08 | 0x17 | CH -L BQ 9 B0 | 4 / 1.31 | 0x7FFFFFFF | Left BQ coefficient |
| 0x0C | 0x17 | CH -L BQ 9 B1 | 4 / 2.30 | 0x00000000 | Left BQ coefficient |
| 0x10 | 0x17 | CH -L BQ 9 B2 | 4 / 1.31 | 0x00000000 | Left BQ coefficient |
| 0x14 | 0x17 | CH -L BQ 9 A1 | 4 / 2.30 | 0x00000000 | Left BQ coefficient |
| 0x18 | 0x17 | CH -L BQ 9 A2 | 4 / 1.31 | 0x00000000 | Left BQ coefficient |
| 0x1C | 0x17 | CH -L BQ 10 B0 | 4 / 1.31 | 0x7FFFFFFF | Left BQ coefficient |
| 0x20 | 0x17 | CH -L BQ 10 B1 | 4 / 2.30 | 0x00000000 | Left BQ coefficient |
| 0x24 | 0x17 | CH -L BQ 10 B2 | 4 / 1.31 | 0x00000000 | Left BQ coefficient |
| 0x28 | 0x17 | CH -L BQ 10 A1 | 4 / 2.30 | 0x00000000 | Left BQ coefficient |
| 0x2C | 0x17 | CH -L BQ 10 A2 | 4 / 1.31 | 0x00000000 | Left BQ coefficient |
| 0x30 | 0x17 | CH -L BQ 11 B0 | 4 / 1.31 | 0x7FFFFFFF | Left BQ coefficient |
| 0x34 | 0x17 | CH -L BQ 11 B1 | 4 / 2.30 | 0x00000000 | Left BQ coefficient |
| 0x38 | 0x17 | CH -L BQ 11 B2 | 4 / 1.31 | 0x00000000 | Left BQ coefficient |
| 0x3C | 0x17 | CH -L BQ 11 A1 | 4 / 2.30 | 0x00000000 | Left BQ coefficient |
| 0x40 | 0x17 | CH -L BQ 11 A2 | 4 / 1.31 | 0x00000000 | Left BQ coefficient |
| 0x44 | 0x17 | CH -L BQ 12 B0 | 4 / 1.31 | 0x7FFFFFFF | Left BQ coefficient |
| 0x48 | 0x17 | CH -L BQ 12 B1 | 4 / 2.30 | 0x00000000 | Left BQ coefficient |
| 0x4C | 0x17 | CH -L BQ 12 B2 | 4 / 1.31 | 0x00000000 | Left BQ coefficient |
| 0x50 | 0x17 | CH -L BQ 12 A1 | 4 / 2.30 | 0x00000000 | Left BQ coefficient |
| 0x54 | 0x17 | CH -L BQ 12 A2 | 4 / 1.31 | 0x00000000 | Left BQ coefficient |
| 0x58 | 0x17 | CH -L BQ 13 B0 | 4 / 1.31 | 0x7FFFFFFF | Left BQ coefficient |
| 0x5C | 0x17 | CH -L BQ 13 B1 | 4 / 2.30 | 0x00000000 | Left BQ coefficient |
| 0x60 | 0x17 | CH -L BQ 13 B2 | 4 / 1.31 | 0x00000000 | Left BQ coefficient |
| 0x64 | 0x17 | CH -L BQ 13 A1 | 4 / 2.30 | 0x00000000 | Left BQ coefficient |
| 0x68 | 0x17 | CH -L BQ 13 A2 | 4 / 1.31 | 0x00000000 | Left BQ coefficient |
| 0x6C | 0x17 | CH -L BQ 14 B0 | 4 / 1.31 | 0x7FFFFFFF | Left BQ coefficient |
| 0x70 | 0x17 | CH -L BQ 14 B1 | 4 / 2.30 | 0x00000000 | Left BQ coefficient |
| 0x74 | 0x17 | CH -L BQ 14 B2 | 4 / 1.31 | 0x00000000 | Left BQ coefficient |
| 0x78 | 0x17 | CH -L BQ 14 A1 | 4 / 2.30 | 0x00000000 | Left BQ coefficient |
| 0x7C | 0x17 | CH -L BQ 14 A2 | 4 / 1.31 | 0x00000000 | Left BQ coefficient |
| LEFT INTGAIN BQ | | | | | |
| 0x08 | 0x18 | CH -L BQ 15 B0 | 4 / 5.27 | 0x08000000 | Left gain scale BQ coefficient |
| 0x0C | 0x18 | CH -L BQ 15 B1 | 4 / 6.26 | 0x00000000 | Left gain scale BQ coefficient |
| 0x10 | 0x18 | CH -L BQ 15 B2 | 4 / 5.27 | 0x00000000 | Left gain scale BQ coefficient |
| 0x14 | 0x18 | CH -L BQ 15 A1 | 4 / 2.30 | 0x00000000 | Left gain scale BQ coefficient |
| 0x18 | 0x18 | CH -L BQ 15 A2 | 4 / 1.31 | 0x00000000 | Left gain scale BQ coefficient |
| EQ RIGHT 14 BQs | | | | | |
| 0x1C | 0x18 | CH -R BQ 1 B0 | 4 / 1.31 | 0x7FFFFFFF | Right BQ coefficient |
| 0x20 | 0x18 | CH -R BQ 1 B1 | 4 / 2.30 | 0x00000000 | Right BQ coefficient |
| 0x24 | 0x18 | CH -R BQ 1 B2 | 4 / 1.31 | 0x00000000 | Right BQ coefficient |
| 0x28 | 0x18 | CH -R BQ 1 A1 | 4 / 2.30 | 0x00000000 | Right BQ coefficient |
| 0x2C | 0x18 | CH -R BQ 1 A2 | 4 / 1.31 | 0x00000000 | Right BQ coefficient |

Table 9. DSP Memory Map for Process Flow 3 — Book 0x8C (continued)

| Sub Address | Page | Register Name | Number of Bytes/Format | Default Value | Description |
|-------------|------|----------------|------------------------|---------------|----------------------|
| 0x30 | 0x18 | CH -R BQ 2 B0 | 4 / 1.31 | 0x7FFFFFFF | Right BQ coefficient |
| 0x34 | 0x18 | CH -R BQ 2 B1 | 4 / 2.30 | 0x00000000 | Right BQ coefficient |
| 0x38 | 0x18 | CH -R BQ 2 B2 | 4 / 1.31 | 0x00000000 | Right BQ coefficient |
| 0x3C | 0x18 | CH -R BQ 2 A1 | 4 / 2.30 | 0x00000000 | Right BQ coefficient |
| 0x40 | 0x18 | CH -R BQ 2 A2 | 4 / 1.31 | 0x00000000 | Right BQ coefficient |
| 0x44 | 0x18 | CH -R BQ 3 B0 | 4 / 1.31 | 0x7FFFFFFF | Right BQ coefficient |
| 0x48 | 0x18 | CH -R BQ 3 B1 | 4 / 2.30 | 0x00000000 | Right BQ coefficient |
| 0x4C | 0x18 | CH -R BQ 3 B2 | 4 / 1.31 | 0x00000000 | Right BQ coefficient |
| 0x50 | 0x18 | CH -R BQ 3 A1 | 4 / 2.30 | 0x00000000 | Right BQ coefficient |
| 0x54 | 0x18 | CH -R BQ 3 A2 | 4 / 1.31 | 0x00000000 | Right BQ coefficient |
| 0x58 | 0x18 | CH -R BQ 4 B0 | 4 / 1.31 | 0x7FFFFFFF | Right BQ coefficient |
| 0x5C | 0x18 | CH -R BQ 4 B1 | 4 / 2.30 | 0x00000000 | Right BQ coefficient |
| 0x60 | 0x18 | CH -R BQ 4 B2 | 4 / 1.31 | 0x00000000 | Right BQ coefficient |
| 0x64 | 0x18 | CH -R BQ 4 A1 | 4 / 2.30 | 0x00000000 | Right BQ coefficient |
| 0x68 | 0x18 | CH -R BQ 4 A2 | 4 / 1.31 | 0x00000000 | Right BQ coefficient |
| 0x6C | 0x18 | CH -R BQ 5 B0 | 4 / 1.31 | 0x7FFFFFFF | Right BQ coefficient |
| 0x70 | 0x18 | CH -R BQ 5 B1 | 4 / 2.30 | 0x00000000 | Right BQ coefficient |
| 0x74 | 0x18 | CH -R BQ 5 B2 | 4 / 1.31 | 0x00000000 | Right BQ coefficient |
| 0x78 | 0x18 | CH -R BQ 5 A1 | 4 / 2.30 | 0x00000000 | Right BQ coefficient |
| 0x7C | 0x18 | CH -R BQ 5 A2 | 4 / 1.31 | 0x00000000 | Right BQ coefficient |
| 0x08 | 0x19 | CH -R BQ 6 B0 | 4 / 1.31 | 0x7FFFFFFF | Right BQ coefficient |
| 0x0C | 0x19 | CH -R BQ 6 B1 | 4 / 2.30 | 0x00000000 | Right BQ coefficient |
| 0x10 | 0x19 | CH -R BQ 6 B2 | 4 / 1.31 | 0x00000000 | Right BQ coefficient |
| 0x14 | 0x19 | CH -R BQ 6 A1 | 4 / 2.30 | 0x00000000 | Right BQ coefficient |
| 0x18 | 0x19 | CH -R BQ 6 A2 | 4 / 1.31 | 0x00000000 | Right BQ coefficient |
| 0x1C | 0x19 | CH -R BQ 7 B0 | 4 / 1.31 | 0x7FFFFFFF | Right BQ coefficient |
| 0x20 | 0x19 | CH -R BQ 7 B1 | 4 / 2.30 | 0x00000000 | Right BQ coefficient |
| 0x24 | 0x19 | CH -R BQ 7 B2 | 4 / 1.31 | 0x00000000 | Right BQ coefficient |
| 0x28 | 0x19 | CH -R BQ 7 A1 | 4 / 2.30 | 0x00000000 | Right BQ coefficient |
| 0x2C | 0x19 | CH -R BQ 7 A2 | 4 / 1.31 | 0x00000000 | Right BQ coefficient |
| 0x30 | 0x19 | CH -R BQ 8 B0 | 4 / 1.31 | 0x7FFFFFFF | Right BQ coefficient |
| 0x34 | 0x19 | CH -R BQ 8 B1 | 4 / 2.30 | 0x00000000 | Right BQ coefficient |
| 0x38 | 0x19 | CH -R BQ 8 B2 | 4 / 1.31 | 0x00000000 | Right BQ coefficient |
| 0x3C | 0x19 | CH -R BQ 8 A1 | 4 / 2.30 | 0x00000000 | Right BQ coefficient |
| 0x40 | 0x19 | CH -R BQ 8 A2 | 4 / 1.31 | 0x00000000 | Right BQ coefficient |
| 0x44 | 0x19 | CH -R BQ 9 B0 | 4 / 1.31 | 0x7FFFFFFF | Right BQ coefficient |
| 0x48 | 0x19 | CH -R BQ 9 B1 | 4 / 2.30 | 0x00000000 | Right BQ coefficient |
| 0x4C | 0x19 | CH -R BQ 9 B2 | 4 / 1.31 | 0x00000000 | Right BQ coefficient |
| 0x50 | 0x19 | CH -R BQ 9 A1 | 4 / 2.30 | 0x00000000 | Right BQ coefficient |
| 0x54 | 0x19 | CH -R BQ 9 A2 | 4 / 1.31 | 0x00000000 | Right BQ coefficient |
| 0x58 | 0x19 | CH -R BQ 10 B0 | 4 / 1.31 | 0x7FFFFFFF | Right BQ coefficient |
| 0x5C | 0x19 | CH -R BQ 10 B1 | 4 / 2.30 | 0x00000000 | Right BQ coefficient |
| 0x60 | 0x19 | CH -R BQ 10 B2 | 4 / 1.31 | 0x00000000 | Right BQ coefficient |
| 0x64 | 0x19 | CH -R BQ 10 A1 | 4 / 2.30 | 0x00000000 | Right BQ coefficient |
| 0x68 | 0x19 | CH -R BQ 10 A2 | 4 / 1.31 | 0x00000000 | Right BQ coefficient |
| 0x6C | 0x19 | CH -R BQ 11 B0 | 4 / 1.31 | 0x7FFFFFFF | Right BQ coefficient |
| 0x70 | 0x19 | CH -R BQ 11 B1 | 4 / 2.30 | 0x00000000 | Right BQ coefficient |
| 0x74 | 0x19 | CH -R BQ 11 B2 | 4 / 1.31 | 0x00000000 | Right BQ coefficient |
| 0x78 | 0x19 | CH -R BQ 11 A1 | 4 / 2.30 | 0x00000000 | Right BQ coefficient |
| 0x7C | 0x19 | CH -R BQ 11 A2 | 4 / 1.31 | 0x00000000 | Right BQ coefficient |
| 0x08 | 0x1A | CH -R BQ 12 B0 | 4 / 1.31 | 0x7FFFFFFF | Right BQ coefficient |

Table 9. DSP Memory Map for Process Flow 3 — Book 0x8C (continued)

| Sub Address | Page | Register Name | Number of Bytes/Format | Default Value | Description |
|----------------------------|------|------------------------|------------------------|---------------|---------------------------------|
| 0x0C | 0x1A | CH -R BQ 12 B1 | 4 / 2.30 | 0x00000000 | Right BQ coefficient |
| 0x10 | 0x1A | CH -R BQ 12 B2 | 4 / 1.31 | 0x00000000 | Right BQ coefficient |
| 0x14 | 0x1A | CH -R BQ 12 A1 | 4 / 2.30 | 0x00000000 | Right BQ coefficient |
| 0x18 | 0x1A | CH -R BQ 12 A2 | 4 / 1.31 | 0x00000000 | Right BQ coefficient |
| 0x1C | 0x1A | CH -R BQ 13 B0 | 4 / 1.31 | 0x7FFFFFFF | Right BQ coefficient |
| 0x20 | 0x1A | CH -R BQ 13 B1 | 4 / 2.30 | 0x00000000 | Right BQ coefficient |
| 0x24 | 0x1A | CH -R BQ 13 B2 | 4 / 1.31 | 0x00000000 | Right BQ coefficient |
| 0x28 | 0x1A | CH -R BQ 13 A1 | 4 / 2.30 | 0x00000000 | Right BQ coefficient |
| 0x2C | 0x1A | CH -R BQ 13 A2 | 4 / 1.31 | 0x00000000 | Right BQ coefficient |
| 0x30 | 0x1A | CH -R BQ 14 B0 | 4 / 1.31 | 0x7FFFFFFF | Right BQ coefficient |
| 0x34 | 0x1A | CH -R BQ 14 B1 | 4 / 2.30 | 0x00000000 | Right BQ coefficient |
| 0x38 | 0x1A | CH -R BQ 14 B2 | 4 / 1.31 | 0x00000000 | Right BQ coefficient |
| 0x3C | 0x1A | CH -R BQ 14 A1 | 4 / 2.30 | 0x00000000 | Right BQ coefficient |
| 0x40 | 0x1A | CH -R BQ 14 A2 | 4 / 1.31 | 0x00000000 | Right BQ coefficient |
| RIGHT INTGAIN BQ | | | | | |
| 0x44 | 0x1A | CH -R BQ 15 B0 | 4 / 5.27 | 0x08000000 | Right gain scale BQ coefficient |
| 0x48 | 0x1A | CH -R BQ 15 B1 | 4 / 6.26 | 0x00000000 | Right gain scale BQ coefficient |
| 0x4C | 0x1A | CH -R BQ 15 B2 | 4 / 5.27 | 0x00000000 | Right gain scale BQ coefficient |
| 0x50 | 0x1A | CH -R BQ 15 A1 | 4 / 2.30 | 0x00000000 | Right gain scale BQ coefficient |
| 0x54 | 0x1A | CH -R BQ 15 A2 | 4 / 1.31 | 0x00000000 | Right gain scale BQ coefficient |
| VOLUME ALPHA FILTER | | | | | |
| 0x58 | 0x1A | Softening Filter Alpha | 4 / 1.31 | 0x00A7264A | Volume time constant |
| PSEUDO 96K | | | | | |
| 0x5C | 0x1A | pseudo96k | 4 / 32.0 | 0x00000000 | Pseudo 96k flag |
| DRC 1 | | | | | |
| 0x6C | 0x1A | DRC1 Energy | 4 / 1.31 | 0x7FFFFFFF | DRC1 Energy Time constant |
| 0x70 | 0x1A | DRC1 Attack | 4 / 1.31 | 0x7FFFFFFF | DRC1 Attack Time constant |
| 0x74 | 0x1A | DRC1 Decay | 4 / 1.31 | 0x7FFFFFFF | DRC1 Decay Time constant |
| 0x78 | 0x1A | K0_1 | 4 / 9.23 | 0x00000000 | DRC1 Region 1 Slope (comp/Exp) |
| 0x7C | 0x1A | K1_1 | 4 / 9.23 | 0x00000000 | DRC1 Region 2 Slope (comp/Exp) |
| 0x08 | 0x1B | K2_1 | 4 / 9.23 | 0x00000000 | DRC1 Region 3 Slope (comp/Exp) |
| 0x0C | 0x1B | T1_1 | 4 / 9.23 | 0xE7000000 | DRC1 Threshold 1 |
| 0x10 | 0x1B | T2_1 | 4 / 9.23 | 0xFE800000 | DRC1 Threshold 2 |
| 0x14 | 0x1B | off1_1 | 4 / 9.23 | 0x00000000 | DRC1 Offset 1 |
| 0x18 | 0x1B | off2_1 | 4 / 9.23 | 0x00000000 | DRC1 Offset 2 |
| DRC 2 | | | | | |
| 0x1C | 0x1B | DRC2 Energy | 4 / 1.31 | 0x7FFFFFFF | DRC2 Energy Time constant |
| 0x20 | 0x1B | DRC2 Attack | 4 / 1.31 | 0x7FFFFFFF | DRC2 Attack Time constant |
| 0x24 | 0x1B | DRC2 Decay | 4 / 1.31 | 0x7FFFFFFF | DRC2 Decay Time constant |
| 0x28 | 0x1B | k0_2 | 4 / 9.23 | 0x00000000 | DRC2 Region 1 Slope (comp/Exp) |
| 0x2C | 0x1B | k1_2 | 4 / 9.23 | 0x00000000 | DRC2 Region 2 Slope (comp/Exp) |
| 0x30 | 0x1B | k2_2 | 4 / 9.23 | 0x00000000 | DRC2 Region 3 Slope (comp/Exp) |
| 0x34 | 0x1B | t1_2 | 4 / 9.23 | 0xE7000000 | DRC2 Threshold 1 |
| 0x38 | 0x1B | t2_2 | 4 / 9.23 | 0xFE800000 | DRC2 Threshold 2 |
| 0x3C | 0x1B | off1_2 | 4 / 9.23 | 0x00000000 | DRC2 Offset 1 |
| 0x40 | 0x1B | off2_2 | 4 / 9.23 | 0x00000000 | DRC2 Offset 2 |
| DRC 3 | | | | | |
| 0x44 | 0x1B | DRC3 Energy | 4 / 1.31 | 0x7FFFFFFF | DRC3 Energy Time constant |
| 0x48 | 0x1B | DRC3 Attack | 4 / 1.31 | 0x7FFFFFFF | DRC3 Attack Time constant |
| 0x4C | 0x1B | DRC3 Decay | 4 / 1.31 | 0x7FFFFFFF | DRC3 Decay Time constant |
| 0x50 | 0x1B | k0_3 | 4 / 9.23 | 0x00000000 | DRC3 Region 1 Slope (comp/Exp) |

Table 9. DSP Memory Map for Process Flow 3 — Book 0x8C (continued)

| Sub Address | Page | Register Name | Number of Bytes/Format | Default Value | Description |
|----------------------------|------|--------------------------|------------------------|---------------|--------------------------------------|
| 0x54 | 0x1B | k1_3 | 4 / 9.23 | 0x00000000 | DRC3 Region 2 Slope (comp/Exp) |
| 0x58 | 0x1B | k1_3 | 4 / 9.23 | 0x00000000 | DRC3 Region 3 Slope (comp/Exp) |
| 0x5C | 0x1B | t1_3 | 4 / 9.23 | 0xE7000000 | DRC3 Threshold 1 |
| 0x60 | 0x1B | t2_3 | 4 / 9.23 | 0xFE800000 | DRC3 Threshold 2 |
| 0x64 | 0x1B | off1_3 | 4 / 9.23 | 0x00000000 | DRC3 Offset 1 |
| 0x68 | 0x1B | off2_3 | 4 / 9.23 | 0x00000000 | DRC3 Offset 2 |
| SPATIALIZER BQs | | | | | |
| 0x6C | 0x1C | BQ 1 B0 | 4 / 1.31 | 0x7FFFFFFF | Spatializer BQ coefficient |
| 0x70 | 0x1C | BQ 1 B1 | 4 / 2.30 | 0x00000000 | Spatializer BQ coefficient |
| 0x74 | 0x1C | BQ 1 B2 | 4 / 1.31 | 0x00000000 | Spatializer BQ coefficient |
| 0x78 | 0x1C | BQ 1 A1 | 4 / 2.30 | 0x00000000 | Spatializer BQ coefficient |
| 0x7C | 0x1C | BQ 1 A2 | 4 / 1.31 | 0x00000000 | Spatializer BQ coefficient |
| 0x08 | 0x1D | BQ 2 B0 | 4 / 1.31 | 0x7FFFFFFF | Spatializer BQ coefficient |
| 0x0C | 0x1D | BQ 2 B1 | 4 / 2.30 | 0x00000000 | Spatializer BQ coefficient |
| 0x10 | 0x1D | BQ 2 B2 | 4 / 1.31 | 0x00000000 | Spatializer BQ coefficient |
| 0x14 | 0x1D | BQ 2 A1 | 4 / 2.30 | 0x00000000 | Spatializer BQ coefficient |
| 0x18 | 0x1D | BQ 2 A2 | 4 / 1.31 | 0x00000000 | Spatializer BQ coefficient |
| DPEQ CONTROL | | | | | |
| 0x1C | 0x1D | Alpha | 4 / 1.31 | 0x02DEAD00 | DPEQ Sense Energy Time constant |
| 0x20 | 0x1D | Gain | 4 / 1.31 | 0x74013901 | DPEQ Threshold Gain |
| 0x24 | 0x1D | Offset | 4 / 1.31 | 0x0020C49B | DPEQ Threshold Offset |
| SUB CHANNEL CONTROL | | | | | |
| 0x28 | 0x1D | No Sub | 4 / 32.0 | 0x00000001 | Sub Channel Flag |
| THD CLIPPER | | | | | |
| 0x2C | 0x1D | CH-LR THD Boost | 4 / 9.23 | 0x00800000 | THD LR Channel pre-scale coefficient |
| 0x34 | 0x1D | CH-L Fine Volume | 4 / 2.30 | 0x3FFFFFFF | THD L Channel post-scale coefficient |
| 0x38 | 0x1D | CH-R Fine Volume | 4 / 2.30 | 0x3FFFFFFF | THD R Channel post-scale coefficient |
| DRC MIXER GAIN | | | | | |
| 0x40 | 0x1D | DRC 1 Mixer Gain | 4 / 9.23 | 0x00800000 | DRC 1 Mixer Gain coefficient |
| 0x44 | 0x1D | DRC 2 Mixer Gain | 4 / 9.23 | 0x00000000 | DRC 2 Mixer Gain coefficient |
| 0x48 | 0x1D | DRC 3 Mixer Gain | 4 / 9.23 | 0x00000000 | DRC 3 Mixer Gain coefficient |
| GANG EQ | | | | | |
| 0x58 | 0x1D | Gang LR EQ | 4 / 32.0 | 0x00000000 | Gang Left and Right EQ flag |
| INPUT MIXER | | | | | |
| 0x5C | 0x1D | Left to Left | 4 / 9.23 | 0x00800000 | Left Channel Mixer Left Input Gain |
| 0x60 | 0x1D | Right to Left | 4 / 9.23 | 0x00000000 | Left Channel Mixer Right Input Gain |
| 0x64 | 0x1D | Left to Right | 4 / 9.23 | 0x00000000 | Right Channel Mixer Left Input Gain |
| 0x68 | 0x1D | Right to Right | 4 / 9.23 | 0x00800000 | Right Channel Mixer Right Input Gain |
| SPATIALIZER LEVEL | | | | | |
| 0x10 | 0x1E | Spatializer Level | 4 / 9.23 | 0x00000000 | Spatializer Level coefficient |
| OUTPUT CROSS BAR | | | | | |
| 0x14 | 0x1E | Digital Left from Left | 4 / 9.23 | 0x00800000 | I2S Left output gain from left |
| 0x18 | 0x1E | Digital Left from Right | 4 / 9.23 | 0x00000000 | I2S Left output gain from Right |
| 0x20 | 0x1E | Digital Right from Left | 4 / 9.23 | 0x00000000 | I2S Right output gain from left |
| 0x24 | 0x1E | Digital Right from Right | 4 / 9.23 | 0x00800000 | I2S Right output gain from Right |
| 0x2C | 0x1E | Analog Left from Left | 4 / 9.23 | 0x00800000 | Analog Left output gain from left |
| 0x30 | 0x1E | Analog Left from Right | 4 / 9.23 | 0x00000000 | Analog Left output gain from Right |
| 0x38 | 0x1E | Analog Right from Left | 4 / 9.23 | 0x00000000 | Analog Right output gain from left |
| 0x3C | 0x1E | Analog Right from Right | 4 / 9.23 | 0x00800000 | Analog Right output gain from Right |

Table 9. DSP Memory Map for Process Flow 3 — Book 0x8C (continued)

| Sub Address | Page | Register Name | Number of Bytes/Format | Default Value | Description |
|------------------------|------|------------------------|------------------------|---------------|----------------------------------|
| VOLUME CONTROL | | | | | |
| 0x44 | 0x1E | CH-L Volume | 4 / 9.23 | 0x00800000 | Left Channel volume coefficient |
| 0x48 | 0x1E | CH-R Volume | 4 / 9.23 | 0x00800000 | Right Channel volume coefficient |
| DPEQ GAIN SCALE | | | | | |
| 0x50 | 0x1E | DPEQ Sense Scale | 4 / 2.30 | 0x40000000 | DPEQ Sense Input Gain |
| 0x54 | 0x1E | DPEQ Low Scale | 4 / 6.26 | 0x04000000 | DPEQ Low Input Gain |
| 0x58 | 0x1E | DPEQ High Scale | 4 / 6.26 | 0x04000000 | DPEQ High Input Gain |
| AGL | | | | | |
| 0x14 | 0x1F | Attack Threshold | 4 / 1.31 | 0x40000000 | Threshold linear |
| 0x18 | 0x1F | Softening Filter Alpha | 4 / 1.31 | 0x06153BD1 | AGL Alpha Time constant |
| 0x1C | 0x1F | Attack Rate | 4 / 1.31 | 0x0001B4E8 | AGL Attack Time constant |
| 0x20 | 0x1F | AGL Enable | 4 / 1.31 | 0x40000000 | AGL Enable flag |
| 0x28 | 0x1F | Softening Filter Omega | 4 / 1.31 | 0x79EAC42F | AGL Omega Time constant |
| 0x2C | 0x1F | Release Rate | 4 / 1.31 | 0x00002BB1 | AGL Release Time constant |

A.4 DSP Memory Map for Process Flow 4

Table 10 lists the DSP memory map for process flow 4.

Table 10. DSP Memory Map for Process Flow 4 — Book 0x8C

| Sub Address | Page | Register Name | Number of Bytes/Format | Default Value | Description |
|--------------------------------|------|----------------|------------------------|---------------|-----------------------------|
| BASS MONO MIXER | | | | | |
| 0x58 | 0x11 | BQ 1 B0 | 4 / 1.31 | 0x7FFFFFFF | Main Channel BQ coefficient |
| 0x5C | 0x11 | BQ 1 B1 | 4 / 2.30 | 0x00000000 | Main Channel BQ coefficient |
| 0x60 | 0x11 | BQ 1 B2 | 4 / 1.31 | 0x00000000 | Main Channel BQ coefficient |
| 0x64 | 0x11 | BQ 1 A1 | 4 / 2.30 | 0x00000000 | Main Channel BQ coefficient |
| 0x68 | 0x11 | BQ 1 A2 | 4 / 1.31 | 0x00000000 | Main Channel BQ coefficient |
| 0x44 | 0x12 | CH-Sub BQ 1 B0 | 4 / 1.31 | 0x7FFFFFFF | Sub Channel BQ coefficient |
| 0x48 | 0x12 | CH-Sub BQ 1 B1 | 4 / 2.30 | 0x00000000 | Sub Channel BQ coefficient |
| 0x4C | 0x12 | CH-Sub BQ 1 B2 | 4 / 1.31 | 0x00000000 | Sub Channel BQ coefficient |
| 0x50 | 0x12 | CH-Sub BQ 1 A1 | 4 / 2.30 | 0x00000000 | Sub Channel BQ coefficient |
| 0x54 | 0x12 | CH-Sub BQ 1 A2 | 4 / 1.31 | 0x00000000 | Sub Channel BQ coefficient |
| DPEQ SENSE BQ | | | | | |
| 0x58 | 0x14 | BQ 1 B0 | 4 / 1.31 | 0x7FFFFFFF | DPEQ sense BQ coefficient |
| 0x5C | 0x14 | BQ 1 B1 | 4 / 2.30 | 0x00000000 | DPEQ sense BQ coefficient |
| 0x60 | 0x14 | BQ 1 B2 | 4 / 1.31 | 0x00000000 | DPEQ sense BQ coefficient |
| 0x64 | 0x14 | BQ 1 A1 | 4 / 2.30 | 0x00000000 | DPEQ sense BQ coefficient |
| 0x68 | 0x14 | BQ 1 A2 | 4 / 1.31 | 0x00000000 | DPEQ sense BQ coefficient |
| 0x6C | 0x14 | BQ 2 B0 | 4 / 1.31 | 0x7FFFFFFF | DPEQ sense BQ coefficient |
| 0x70 | 0x14 | BQ 2 B1 | 4 / 2.30 | 0x00000000 | DPEQ sense BQ coefficient |
| 0x74 | 0x14 | BQ 2 B2 | 4 / 1.31 | 0x00000000 | DPEQ sense BQ coefficient |
| 0x78 | 0x14 | BQ 2 A1 | 4 / 2.30 | 0x00000000 | DPEQ sense BQ coefficient |
| 0x7C | 0x14 | BQ 2 A2 | 4 / 1.31 | 0x00000000 | DPEQ sense BQ coefficient |
| DPEQ LOW LEVEL PATH BQ | | | | | |
| 0x08 | 0x15 | BQ 1 B0 | 4 / 1.31 | 0x7FFFFFFF | DPEQ low BQ coefficient |
| 0x0C | 0x15 | BQ 1 B1 | 4 / 2.30 | 0x00000000 | DPEQ low BQ coefficient |
| 0x10 | 0x15 | BQ 1 B2 | 4 / 1.31 | 0x00000000 | DPEQ low BQ coefficient |
| 0x14 | 0x15 | BQ 1 A1 | 4 / 2.30 | 0x00000000 | DPEQ low BQ coefficient |
| 0x18 | 0x15 | BQ 1 A2 | 4 / 1.31 | 0x00000000 | DPEQ low BQ coefficient |
| 0x1C | 0x15 | BQ 2 B0 | 4 / 1.31 | 0x7FFFFFFF | DPEQ low BQ coefficient |
| 0x20 | 0x15 | BQ 2 B1 | 4 / 2.30 | 0x00000000 | DPEQ low BQ coefficient |
| 0x24 | 0x15 | BQ 2 B2 | 4 / 1.31 | 0x00000000 | DPEQ low BQ coefficient |
| 0x28 | 0x15 | BQ 2 A1 | 4 / 2.30 | 0x00000000 | DPEQ low BQ coefficient |
| 0x2C | 0x15 | BQ 2 A2 | 4 / 1.31 | 0x00000000 | DPEQ low BQ coefficient |
| DPEQ HIGH LEVEL PATH BQ | | | | | |
| 0x30 | 0x15 | BQ 1 B0 | 4 / 1.31 | 0x7FFFFFFF | DPEQ high BQ coefficient |
| 0x34 | 0x15 | BQ 1 B1 | 4 / 2.30 | 0x00000000 | DPEQ high BQ coefficient |
| 0x38 | 0x15 | BQ 1 B2 | 4 / 1.31 | 0x00000000 | DPEQ high BQ coefficient |
| 0x3C | 0x15 | BQ 1 A1 | 4 / 2.30 | 0x00000000 | DPEQ high BQ coefficient |
| 0x40 | 0x15 | BQ 1 A2 | 4 / 1.31 | 0x00000000 | DPEQ high BQ coefficient |
| 0x44 | 0x15 | BQ 2 B0 | 4 / 1.31 | 0x7FFFFFFF | DPEQ high BQ coefficient |
| 0x48 | 0x15 | BQ 2 B1 | 4 / 2.30 | 0x00000000 | DPEQ high BQ coefficient |
| 0x4C | 0x15 | BQ 2 B2 | 4 / 1.31 | 0x00000000 | DPEQ high BQ coefficient |
| 0x50 | 0x15 | BQ 2 A1 | 4 / 2.30 | 0x00000000 | DPEQ high BQ coefficient |
| 0x54 | 0x15 | BQ 2 A2 | 4 / 1.31 | 0x00000000 | DPEQ high BQ coefficient |
| EQ LEFT 14 BQs | | | | | |
| 0x58 | 0x15 | CH -L BQ 1 B0 | 4 / 1.31 | 0x7FFFFFFF | Left BQ coefficient |
| 0x5C | 0x15 | CH -L BQ 1 B1 | 4 / 2.30 | 0x00000000 | Left BQ coefficient |
| 0x60 | 0x15 | CH -L BQ 1 B2 | 4 / 1.31 | 0x00000000 | Left BQ coefficient |

Table 10. DSP Memory Map for Process Flow 4 — Book 0x8C (continued)

| Sub Address | Page | Register Name | Number of Bytes/Format | Default Value | Description |
|-------------|------|----------------|------------------------|---------------|---------------------|
| 0x64 | 0x15 | CH -L BQ 1 A1 | 4 / 2.30 | 0x00000000 | Left BQ coefficient |
| 0x68 | 0x15 | CH -L BQ 1 A2 | 4 / 1.31 | 0x00000000 | Left BQ coefficient |
| 0x6C | 0x15 | CH -L BQ 2 B0 | 4 / 1.31 | 0x7FFFFFFF | Left BQ coefficient |
| 0x70 | 0x15 | CH -L BQ 2 B1 | 4 / 2.30 | 0x00000000 | Left BQ coefficient |
| 0x74 | 0x15 | CH -L BQ 2 B2 | 4 / 1.31 | 0x00000000 | Left BQ coefficient |
| 0x78 | 0x15 | CH -L BQ 2 A1 | 4 / 2.30 | 0x00000000 | Left BQ coefficient |
| 0x7C | 0x15 | CH -L BQ 2 A2 | 4 / 1.31 | 0x00000000 | Left BQ coefficient |
| 0x08 | 0x16 | CH -L BQ 3 B0 | 4 / 1.31 | 0x7FFFFFFF | Left BQ coefficient |
| 0x0C | 0x16 | CH -L BQ 3 B1 | 4 / 2.30 | 0x00000000 | Left BQ coefficient |
| 0x10 | 0x16 | CH -L BQ 3 B2 | 4 / 1.31 | 0x00000000 | Left BQ coefficient |
| 0x14 | 0x16 | CH -L BQ 3 A1 | 4 / 2.30 | 0x00000000 | Left BQ coefficient |
| 0x18 | 0x16 | CH -L BQ 3 A2 | 4 / 1.31 | 0x00000000 | Left BQ coefficient |
| 0x1C | 0x16 | CH -L BQ 4 B0 | 4 / 1.31 | 0x7FFFFFFF | Left BQ coefficient |
| 0x20 | 0x16 | CH -L BQ 4 B1 | 4 / 2.30 | 0x00000000 | Left BQ coefficient |
| 0x24 | 0x16 | CH -L BQ 4 B2 | 4 / 1.31 | 0x00000000 | Left BQ coefficient |
| 0x28 | 0x16 | CH -L BQ 4 A1 | 4 / 2.30 | 0x00000000 | Left BQ coefficient |
| 0x2C | 0x16 | CH -L BQ 4 A2 | 4 / 1.31 | 0x00000000 | Left BQ coefficient |
| 0x30 | 0x16 | CH -L BQ 5 B0 | 4 / 1.31 | 0x7FFFFFFF | Left BQ coefficient |
| 0x34 | 0x16 | CH -L BQ 5 B1 | 4 / 2.30 | 0x00000000 | Left BQ coefficient |
| 0x38 | 0x16 | CH -L BQ 5 B2 | 4 / 1.31 | 0x00000000 | Left BQ coefficient |
| 0x3C | 0x16 | CH -L BQ 5 A1 | 4 / 2.30 | 0x00000000 | Left BQ coefficient |
| 0x40 | 0x16 | CH -L BQ 5 A2 | 4 / 1.31 | 0x00000000 | Left BQ coefficient |
| 0x44 | 0x16 | CH -L BQ 6 B0 | 4 / 1.31 | 0x7FFFFFFF | Left BQ coefficient |
| 0x48 | 0x16 | CH -L BQ 6 B1 | 4 / 2.30 | 0x00000000 | Left BQ coefficient |
| 0x4C | 0x16 | CH -L BQ 6 B2 | 4 / 1.31 | 0x00000000 | Left BQ coefficient |
| 0x50 | 0x16 | CH -L BQ 6 A1 | 4 / 2.30 | 0x00000000 | Left BQ coefficient |
| 0x54 | 0x16 | CH -LBQ 6 A2 | 4 / 1.31 | 0x00000000 | Left BQ coefficient |
| 0x58 | 0x16 | CH -L BQ 7 B0 | 4 / 1.31 | 0x7FFFFFFF | Left BQ coefficient |
| 0x5C | 0x16 | CH -L BQ 7 B1 | 4 / 2.30 | 0x00000000 | Left BQ coefficient |
| 0x60 | 0x16 | CH -L BQ 7 B2 | 4 / 1.31 | 0x00000000 | Left BQ coefficient |
| 0x64 | 0x16 | CH -L BQ 7 A1 | 4 / 2.30 | 0x00000000 | Left BQ coefficient |
| 0x68 | 0x16 | CH -L BQ 7 A2 | 4 / 1.31 | 0x00000000 | Left BQ coefficient |
| 0x6C | 0x16 | CH -L BQ 8 B0 | 4 / 1.31 | 0x7FFFFFFF | Left BQ coefficient |
| 0x70 | 0x16 | CH -L BQ 8 B1 | 4 / 2.30 | 0x00000000 | Left BQ coefficient |
| 0x74 | 0x16 | CH -L BQ 8 B2 | 4 / 1.31 | 0x00000000 | Left BQ coefficient |
| 0x78 | 0x16 | CH -L BQ 8 A1 | 4 / 2.30 | 0x00000000 | Left BQ coefficient |
| 0x7C | 0x16 | CH -L BQ 8 A2 | 4 / 1.31 | 0x00000000 | Left BQ coefficient |
| 0x08 | 0x17 | CH -L BQ 9 B0 | 4 / 1.31 | 0x7FFFFFFF | Left BQ coefficient |
| 0x0C | 0x17 | CH -L BQ 9 B1 | 4 / 2.30 | 0x00000000 | Left BQ coefficient |
| 0x10 | 0x17 | CH -L BQ 9 B2 | 4 / 1.31 | 0x00000000 | Left BQ coefficient |
| 0x14 | 0x17 | CH -L BQ 9 A1 | 4 / 2.30 | 0x00000000 | Left BQ coefficient |
| 0x18 | 0x17 | CH -L BQ 9 A2 | 4 / 1.31 | 0x00000000 | Left BQ coefficient |
| 0x1C | 0x17 | CH -L BQ 10 B0 | 4 / 1.31 | 0x7FFFFFFF | Left BQ coefficient |
| 0x20 | 0x17 | CH -L BQ 10 B1 | 4 / 2.30 | 0x00000000 | Left BQ coefficient |
| 0x24 | 0x17 | CH -L BQ 10 B2 | 4 / 1.31 | 0x00000000 | Left BQ coefficient |
| 0x28 | 0x17 | CH -L BQ 10 A1 | 4 / 2.30 | 0x00000000 | Left BQ coefficient |
| 0x2C | 0x17 | CH -L BQ 10 A2 | 4 / 1.31 | 0x00000000 | Left BQ coefficient |
| 0x30 | 0x17 | CH -L BQ 11 B0 | 4 / 1.31 | 0x7FFFFFFF | Left BQ coefficient |
| 0x34 | 0x17 | CH -L BQ 11 B1 | 4 / 2.30 | 0x00000000 | Left BQ coefficient |
| 0x38 | 0x17 | CH -L BQ 11 B2 | 4 / 1.31 | 0x00000000 | Left BQ coefficient |
| 0x3C | 0x17 | CH -L BQ 11 A1 | 4 / 2.30 | 0x00000000 | Left BQ coefficient |

Table 10. DSP Memory Map for Process Flow 4 — Book 0x8C (continued)

| Sub Address | Page | Register Name | Number of Bytes/Format | Default Value | Description |
|------------------------|------|----------------|------------------------|---------------|--------------------------------|
| 0x40 | 0x17 | CH -L BQ 11 A2 | 4 / 1.31 | 0x00000000 | Left BQ coefficient |
| 0x44 | 0x17 | CH -L BQ 12 B0 | 4 / 1.31 | 0x7FFFFFFF | Left BQ coefficient |
| 0x48 | 0x17 | CH -L BQ 12 B1 | 4 / 2.30 | 0x00000000 | Left BQ coefficient |
| 0x4C | 0x17 | CH -L BQ 12 B2 | 4 / 1.31 | 0x00000000 | Left BQ coefficient |
| 0x50 | 0x17 | CH -L BQ 12 A1 | 4 / 2.30 | 0x00000000 | Left BQ coefficient |
| 0x54 | 0x17 | CH -L BQ 12 A2 | 4 / 1.31 | 0x00000000 | Left BQ coefficient |
| 0x58 | 0x17 | CH -L BQ 13 B0 | 4 / 1.31 | 0x7FFFFFFF | Left BQ coefficient |
| 0x5C | 0x17 | CH -L BQ 13 B1 | 4 / 2.30 | 0x00000000 | Left BQ coefficient |
| 0x60 | 0x17 | CH -L BQ 13 B2 | 4 / 1.31 | 0x00000000 | Left BQ coefficient |
| 0x64 | 0x17 | CH -L BQ 13 A1 | 4 / 2.30 | 0x00000000 | Left BQ coefficient |
| 0x68 | 0x17 | CH -L BQ 13 A2 | 4 / 1.31 | 0x00000000 | Left BQ coefficient |
| 0x6C | 0x17 | CH -L BQ 14 B0 | 4 / 1.31 | 0x7FFFFFFF | Left BQ coefficient |
| 0x70 | 0x17 | CH -L BQ 14 B1 | 4 / 2.30 | 0x00000000 | Left BQ coefficient |
| 0x74 | 0x17 | CH -L BQ 14 B2 | 4 / 1.31 | 0x00000000 | Left BQ coefficient |
| 0x78 | 0x17 | CH -L BQ 14 A1 | 4 / 2.30 | 0x00000000 | Left BQ coefficient |
| 0x7C | 0x17 | CH -L BQ 14 A2 | 4 / 1.31 | 0x00000000 | Left BQ coefficient |
| LEFT INTGAIN BQ | | | | | |
| 0x08 | 0x18 | CH -L BQ 15 B0 | 4 / 5.27 | 0x08000000 | Left gain scale BQ coefficient |
| 0x0C | 0x18 | CH -L BQ 15 B1 | 4 / 6.26 | 0x00000000 | Left gain scale BQ coefficient |
| 0x10 | 0x18 | CH -L BQ 15 B2 | 4 / 5.27 | 0x00000000 | Left gain scale BQ coefficient |
| 0x14 | 0x18 | CH -L BQ 15 A1 | 4 / 2.30 | 0x00000000 | Left gain scale BQ coefficient |
| 0x18 | 0x18 | CH -L BQ 15 A2 | 4 / 1.31 | 0x00000000 | Left gain scale BQ coefficient |
| EQ RIGHT 14 BQs | | | | | |
| 0x1C | 0x18 | CH -R BQ 1 B0 | 4 / 1.31 | 0x7FFFFFFF | Right BQ coefficient |
| 0x20 | 0x18 | CH -R BQ 1 B1 | 4 / 2.30 | 0x00000000 | Right BQ coefficient |
| 0x24 | 0x18 | CH -R BQ 1 B2 | 4 / 1.31 | 0x00000000 | Right BQ coefficient |
| 0x28 | 0x18 | CH -R BQ 1 A1 | 4 / 2.30 | 0x00000000 | Right BQ coefficient |
| 0x2C | 0x18 | CH -R BQ 1 A2 | 4 / 1.31 | 0x00000000 | Right BQ coefficient |
| 0x30 | 0x18 | CH -R BQ 2 B0 | 4 / 1.31 | 0x7FFFFFFF | Right BQ coefficient |
| 0x34 | 0x18 | CH -R BQ 2 B1 | 4 / 2.30 | 0x00000000 | Right BQ coefficient |
| 0x38 | 0x18 | CH -R BQ 2 B2 | 4 / 1.31 | 0x00000000 | Right BQ coefficient |
| 0x3C | 0x18 | CH -R BQ 2 A1 | 4 / 2.30 | 0x00000000 | Right BQ coefficient |
| 0x40 | 0x18 | CH -R BQ 2 A2 | 4 / 1.31 | 0x00000000 | Right BQ coefficient |
| 0x44 | 0x18 | CH -R BQ 3 B0 | 4 / 1.31 | 0x7FFFFFFF | Right BQ coefficient |
| 0x48 | 0x18 | CH -R BQ 3 B1 | 4 / 2.30 | 0x00000000 | Right BQ coefficient |
| 0x4C | 0x18 | CH -R BQ 3 B2 | 4 / 1.31 | 0x00000000 | Right BQ coefficient |
| 0x50 | 0x18 | CH -R BQ 3 A1 | 4 / 2.30 | 0x00000000 | Right BQ coefficient |
| 0x54 | 0x18 | CH -R BQ 3 A2 | 4 / 1.31 | 0x00000000 | Right BQ coefficient |
| 0x58 | 0x18 | CH -R BQ 4 B0 | 4 / 1.31 | 0x7FFFFFFF | Right BQ coefficient |
| 0x5C | 0x18 | CH -R BQ 4 B1 | 4 / 2.30 | 0x00000000 | Right BQ coefficient |
| 0x60 | 0x18 | CH -R BQ 4 B2 | 4 / 1.31 | 0x00000000 | Right BQ coefficient |
| 0x64 | 0x18 | CH -R BQ 4 A1 | 4 / 2.30 | 0x00000000 | Right BQ coefficient |
| 0x68 | 0x18 | CH -R BQ 4 A2 | 4 / 1.31 | 0x00000000 | Right BQ coefficient |
| 0x6C | 0x18 | CH -R BQ 5 B0 | 4 / 1.31 | 0x7FFFFFFF | Right BQ coefficient |
| 0x70 | 0x18 | CH -R BQ 5 B1 | 4 / 2.30 | 0x00000000 | Right BQ coefficient |
| 0x74 | 0x18 | CH -R BQ 5 B2 | 4 / 1.31 | 0x00000000 | Right BQ coefficient |
| 0x78 | 0x18 | CH -R BQ 5 A1 | 4 / 2.30 | 0x00000000 | Right BQ coefficient |
| 0x7C | 0x18 | CH -R BQ 5 A2 | 4 / 1.31 | 0x00000000 | Right BQ coefficient |
| 0x08 | 0x19 | CH -R BQ 6 B0 | 4 / 1.31 | 0x7FFFFFFF | Right BQ coefficient |
| 0x0C | 0x19 | CH -R BQ 6 B1 | 4 / 2.30 | 0x00000000 | Right BQ coefficient |
| 0x10 | 0x19 | CH -R BQ 6 B2 | 4 / 1.31 | 0x00000000 | Right BQ coefficient |

Table 10. DSP Memory Map for Process Flow 4 — Book 0x8C (continued)

| Sub Address | Page | Register Name | Number of Bytes/Format | Default Value | Description |
|----------------------------|------|------------------------|------------------------|---------------|---------------------------------|
| 0x14 | 0x19 | CH -R BQ 6 A1 | 4 / 2.30 | 0x00000000 | Right BQ coefficient |
| 0x18 | 0x19 | CH -R BQ 6 A2 | 4 / 1.31 | 0x00000000 | Right BQ coefficient |
| 0x1C | 0x19 | CH -R BQ 7 B0 | 4 / 1.31 | 0x7FFFFFFF | Right BQ coefficient |
| 0x20 | 0x19 | CH -R BQ 7 B1 | 4 / 2.30 | 0x00000000 | Right BQ coefficient |
| 0x24 | 0x19 | CH -R BQ 7 B2 | 4 / 1.31 | 0x00000000 | Right BQ coefficient |
| 0x28 | 0x19 | CH -R BQ 7 A1 | 4 / 2.30 | 0x00000000 | Right BQ coefficient |
| 0x2C | 0x19 | CH -R BQ 7 A2 | 4 / 1.31 | 0x00000000 | Right BQ coefficient |
| 0x30 | 0x19 | CH -R BQ 8 B0 | 4 / 1.31 | 0x7FFFFFFF | Right BQ coefficient |
| 0x34 | 0x19 | CH -R BQ 8 B1 | 4 / 2.30 | 0x00000000 | Right BQ coefficient |
| 0x38 | 0x19 | CH -R BQ 8 B2 | 4 / 1.31 | 0x00000000 | Right BQ coefficient |
| 0x3C | 0x19 | CH -R BQ 8 A1 | 4 / 2.30 | 0x00000000 | Right BQ coefficient |
| 0x40 | 0x19 | CH -R BQ 8 A2 | 4 / 1.31 | 0x00000000 | Right BQ coefficient |
| 0x44 | 0x19 | CH -R BQ 9 B0 | 4 / 1.31 | 0x7FFFFFFF | Right BQ coefficient |
| 0x48 | 0x19 | CH -R BQ 9 B1 | 4 / 2.30 | 0x00000000 | Right BQ coefficient |
| 0x4C | 0x19 | CH -R BQ 9 B2 | 4 / 1.31 | 0x00000000 | Right BQ coefficient |
| 0x50 | 0x19 | CH -R BQ 9 A1 | 4 / 2.30 | 0x00000000 | Right BQ coefficient |
| 0x54 | 0x19 | CH -R BQ 9 A2 | 4 / 1.31 | 0x00000000 | Right BQ coefficient |
| 0x58 | 0x19 | CH -R BQ 10 B0 | 4 / 1.31 | 0x7FFFFFFF | Right BQ coefficient |
| 0x5C | 0x19 | CH -R BQ 10 B1 | 4 / 2.30 | 0x00000000 | Right BQ coefficient |
| 0x60 | 0x19 | CH -R BQ 10 B2 | 4 / 1.31 | 0x00000000 | Right BQ coefficient |
| 0x64 | 0x19 | CH -R BQ 10 A1 | 4 / 2.30 | 0x00000000 | Right BQ coefficient |
| 0x68 | 0x19 | CH -R BQ 10 A2 | 4 / 1.31 | 0x00000000 | Right BQ coefficient |
| 0x6C | 0x19 | CH -R BQ 11 B0 | 4 / 1.31 | 0x7FFFFFFF | Right BQ coefficient |
| 0x70 | 0x19 | CH -R BQ 11 B1 | 4 / 2.30 | 0x00000000 | Right BQ coefficient |
| 0x74 | 0x19 | CH -R BQ 11 B2 | 4 / 1.31 | 0x00000000 | Right BQ coefficient |
| 0x78 | 0x19 | CH -R BQ 11 A1 | 4 / 2.30 | 0x00000000 | Right BQ coefficient |
| 0x7C | 0x19 | CH -R BQ 11 A2 | 4 / 1.31 | 0x00000000 | Right BQ coefficient |
| 0x08 | 0x1A | CH -R BQ 12 B0 | 4 / 1.31 | 0x7FFFFFFF | Right BQ coefficient |
| 0x0C | 0x1A | CH -R BQ 12 B1 | 4 / 2.30 | 0x00000000 | Right BQ coefficient |
| 0x10 | 0x1A | CH -R BQ 12 B2 | 4 / 1.31 | 0x00000000 | Right BQ coefficient |
| 0x14 | 0x1A | CH -R BQ 12 A1 | 4 / 2.30 | 0x00000000 | Right BQ coefficient |
| 0x18 | 0x1A | CH -R BQ 12 A2 | 4 / 1.31 | 0x00000000 | Right BQ coefficient |
| 0x1C | 0x1A | CH -R BQ 13 B0 | 4 / 1.31 | 0x7FFFFFFF | Right BQ coefficient |
| 0x20 | 0x1A | CH -R BQ 13 B1 | 4 / 2.30 | 0x00000000 | Right BQ coefficient |
| 0x24 | 0x1A | CH -R BQ 13 B2 | 4 / 1.31 | 0x00000000 | Right BQ coefficient |
| 0x28 | 0x1A | CH -R BQ 13 A1 | 4 / 2.30 | 0x00000000 | Right BQ coefficient |
| 0x2C | 0x1A | CH -R BQ 13 A2 | 4 / 1.31 | 0x00000000 | Right BQ coefficient |
| 0x30 | 0x1A | CH -R BQ 14 B0 | 4 / 1.31 | 0x7FFFFFFF | Right BQ coefficient |
| 0x34 | 0x1A | CH -R BQ 14 B1 | 4 / 2.30 | 0x00000000 | Right BQ coefficient |
| 0x38 | 0x1A | CH -R BQ 14 B2 | 4 / 1.31 | 0x00000000 | Right BQ coefficient |
| 0x3C | 0x1A | CH -R BQ 14 A1 | 4 / 2.30 | 0x00000000 | Right BQ coefficient |
| 0x40 | 0x1A | CH -R BQ 14 A2 | 4 / 1.31 | 0x00000000 | Right BQ coefficient |
| RIGHT INTGAIN BQ | | | | | |
| 0x44 | 0x1A | CH -R BQ 15 B0 | 4 / 5.27 | 0x08000000 | Right gain scale BQ coefficient |
| 0x48 | 0x1A | CH -R BQ 15 B1 | 4 / 6.26 | 0x00000000 | Right gain scale BQ coefficient |
| 0x4C | 0x1A | CH -R BQ 15 B2 | 4 / 5.27 | 0x00000000 | Right gain scale BQ coefficient |
| 0x50 | 0x1A | CH -R BQ 15 A1 | 4 / 2.30 | 0x00000000 | Right gain scale BQ coefficient |
| 0x54 | 0x1A | CH -R BQ 15 A2 | 4 / 1.31 | 0x00000000 | Right gain scale BQ coefficient |
| VOLUME ALPHA FILTER | | | | | |
| 0x58 | 0x1A | Softening Filter Alpha | 4 / 1.31 | 0x00A7264A | Volume time constant |

Table 10. DSP Memory Map for Process Flow 4 — Book 0x8C (continued)

| Sub Address | Page | Register Name | Number of Bytes/Format | Default Value | Description |
|----------------------------|------|--------------------------|------------------------|---------------|--------------------------------------|
| PSEUDO 96K | | | | | |
| 0x5C | 0x1A | pseudo96k | 4 / 32.0 | 0x00000000 | Pseudo 96k flag |
| SPATIALIZER BQs | | | | | |
| 0x6C | 0x1C | BQ 1 B0 | 4 / 1.31 | 0x7FFFFFFF | Spatializer BQ coefficient |
| 0x70 | 0x1C | BQ 1 B1 | 4 / 2.30 | 0x00000000 | Spatializer BQ coefficient |
| 0x74 | 0x1C | BQ 1 B2 | 4 / 1.31 | 0x00000000 | Spatializer BQ coefficient |
| 0x78 | 0x1C | BQ 1 A1 | 4 / 2.30 | 0x00000000 | Spatializer BQ coefficient |
| 0x7C | 0x1C | BQ 1 A2 | 4 / 1.31 | 0x00000000 | Spatializer BQ coefficient |
| 0x08 | 0x1D | BQ 2 B0 | 4 / 1.31 | 0x7FFFFFFF | Spatializer BQ coefficient |
| 0x0C | 0x1D | BQ 2 B1 | 4 / 2.30 | 0x00000000 | Spatializer BQ coefficient |
| 0x10 | 0x1D | BQ 2 B2 | 4 / 1.31 | 0x00000000 | Spatializer BQ coefficient |
| 0x14 | 0x1D | BQ 2 A1 | 4 / 2.30 | 0x00000000 | Spatializer BQ coefficient |
| 0x18 | 0x1D | BQ 2 A2 | 4 / 1.31 | 0x00000000 | Spatializer BQ coefficient |
| DPEQ CONTROL | | | | | |
| 0x1C | 0x1D | Alpha | 4 / 1.31 | 0x02DEAD00 | DPEQ Sense Energy Time constant |
| 0x20 | 0x1D | Gain | 4 / 1.31 | 0x74013901 | DPEQ Threshold Gain |
| 0x24 | 0x1D | Offset | 4 / 1.31 | 0x0020C49B | DPEQ Threshold Offset |
| SUB CHANNEL CONTROL | | | | | |
| 0x28 | 0x1D | No Sub | 4 / 32.0 | 0x00000001 | Sub Channel Flag |
| THD CLIPPER | | | | | |
| 0x2C | 0x1D | CH-LR THD Boost | 4 / 9.23 | 0x00800000 | THD LR Channel pre-scale coefficient |
| 0x34 | 0x1D | CH-L Fine Volume | 4 / 2.30 | 0x3FFFFFFF | THD L Channel post-scale coefficient |
| 0x38 | 0x1D | CH-R Fine Volume | 4 / 2.30 | 0x3FFFFFFF | THD R Channel post-scale coefficient |
| GANG EQ | | | | | |
| 0x58 | 0x1D | Gang LR EQ | 4 / 32.0 | 0x00000000 | Gang Left and Right EQ flag |
| INPUT MIXER | | | | | |
| 0x5C | 0x1D | Left to Left | 4 / 9.23 | 0x00800000 | Left Channel Mixer Left Input Gain |
| 0x60 | 0x1D | Right to Left | 4 / 9.23 | 0x00000000 | Left Channel Mixer Right Input Gain |
| 0x64 | 0x1D | Left to Right | 4 / 9.23 | 0x00000000 | Right Channel Mixer Left Input Gain |
| 0x68 | 0x1D | Right to Right | 4 / 9.23 | 0x00800000 | Right Channel Mixer Right Input Gain |
| SPATIALIZER LEVEL | | | | | |
| 0x10 | 0x1E | Spatializer Level | 4 / 9.23 | 0x00000000 | Spatializer Level coefficient |
| OUTPUT CROSS BAR | | | | | |
| 0x14 | 0x1E | Digital Left from Left | 4 / 9.23 | 0x00800000 | I2S Left output gain from left |
| 0x18 | 0x1E | Digital Left from Right | 4 / 9.23 | 0x00000000 | I2S Left output gain from Right |
| 0x20 | 0x1E | Digital Right from Left | 4 / 9.23 | 0x00000000 | I2S Right output gain from left |
| 0x24 | 0x1E | Digital Right from Right | 4 / 9.23 | 0x00800000 | I2S Right output gain from Right |
| 0x2C | 0x1E | Analog Left from Left | 4 / 9.23 | 0x00800000 | Analog Left output gain from left |
| 0x30 | 0x1E | Analog Left from Right | 4 / 9.23 | 0x00000000 | Analog Left output gain from Right |
| 0x38 | 0x1E | Analog Right from Left | 4 / 9.23 | 0x00000000 | Analog Right output gain from left |
| 0x3C | 0x1E | Analog Right from Right | 4 / 9.23 | 0x00800000 | Analog Right output gain from Right |
| VOLUME CONTROL | | | | | |
| 0x44 | 0x1E | CH-L Volume | 4 / 9.23 | 0x00800000 | Left Channel volume coefficient |
| 0x48 | 0x1E | CH-R Volume | 4 / 9.23 | 0x00800000 | Right Channel volume coefficient |
| DPEQ GAIN SCALE | | | | | |
| 0x50 | 0x1E | DPEQ Sense Scale | 4 / 2.30 | 0x40000000 | DPEQ Sense Input Gain |
| 0x54 | 0x1E | DPEQ Low Scale | 4 / 6.26 | 0x04000000 | DPEQ Low Input Gain |
| 0x58 | 0x1E | DPEQ High Scale | 4 / 6.26 | 0x04000000 | DPEQ High Input Gain |
| THERMAL PROTECT | | | | | |
| 0x5C | 0x1E | Thermal | 4 / - | 0x0020C49C | Generated by GUI |
| 0x60 | 0x1E | Thermal | 4 / - | 0x0020C49C | Generated by GUI |

Table 10. DSP Memory Map for Process Flow 4 — Book 0x8C (continued)

| Sub Address | Page | Register Name | Number of Bytes/Format | Default Value | Description |
|-------------------------------|------|-----------------|------------------------|---------------|------------------------------------|
| 0x64 | 0x1E | Thermal | 4 / - | 0x0020C49C | Generated by GUI |
| 0x68 | 0x1E | Thermal | 4 / - | 0x0020C49C | Generated by GUI |
| THERMAL PROTECT ENERGY | | | | | |
| 0x34 | 0x1F | Thermal | 4 / - | 0x00A7264A | Generated by GUI |
| MORPHING CONTROL | | | | | |
| 0x38 | 0x1F | Morphing Energy | 4 / 1.31 | 0x7FFFFFFF | Morphing Energy Time constant |
| 0x3C | 0x1F | Morphing Attack | 4 / 1.31 | 0x7FFFFFFF | Morphing Attack Time constant |
| 0x40 | 0x1F | Morphing Decay | 4 / 1.31 | 0x7FFFFFFF | Morphing Decay Time constant |
| 0x44 | 0x1F | Morphing K0_1 | 4 / 9.23 | 0x00000000 | Morphing Region 1 Slope (comp/Exp) |
| 0x48 | 0x1F | Morphing K1_1 | 4 / 9.23 | 0x00000000 | Morphing Region 2 Slope (comp/Exp) |
| 0x4C | 0x1F | Morphing K2_1 | 4 / 9.23 | 0x00000000 | Morphing Region 3 Slope (comp/Exp) |
| 0x50 | 0x1F | Morphing T1_1 | 4 / 9.23 | 0xE7000000 | Morphing Threshold 1 |
| 0x54 | 0x1F | Morphing T2_1 | 4 / 9.23 | 0xFE800000 | Morphing Threshold 2 |
| 0x58 | 0x1F | Morphing off1_1 | 4 / 9.23 | 0x00000000 | Morphing Offset 1 |
| 0x5C | 0x1F | Morphing off2_1 | 4 / 9.23 | 0x00000000 | Morphing Offset 2 |
| EXCURSION | | | | | |
| 0x60 | 0x1F | Excursion | 4 / - | 0x024D9999 | Generated by GUI |
| 0x64 | 0x1F | Excursion | 4 / - | 0xFDB26667 | Generated by GUI |
| 0x68 | 0x1F | Excursion | 4 / - | 0x00800000 | Generated by GUI |
| 0x6C | 0x1F | Excursion | 4 / - | 0x00000000 | Generated by GUI |
| 0x70 | 0x1F | Excursion | 4 / - | 0x00000000 | Generated by GUI |
| 0x74 | 0x1F | Excursion | 4 / - | 0x00000000 | Generated by GUI |
| 0x78 | 0x1F | Excursion | 4 / - | 0x00000000 | Generated by GUI |
| 0x7C | 0x1F | Excursion | 4 / - | 0x00000000 | Generated by GUI |
| 0x08 | 0x20 | Excursion | 4 / - | 0x00000000 | Generated by GUI |
| 0x0C | 0x20 | Excursion | 4 / - | 0x00000000 | Generated by GUI |
| 0x10 | 0x20 | Excursion | 4 / - | 0x00000000 | Generated by GUI |
| 0x14 | 0x20 | Excursion | 4 / - | 0x00000000 | Generated by GUI |
| 0x18 | 0x20 | Excursion | 4 / - | 0x00000000 | Generated by GUI |
| 0x1C | 0x20 | Excursion | 4 / - | 0x00000000 | Generated by GUI |
| 0x20 | 0x20 | Excursion | 4 / - | 0x00000000 | Generated by GUI |
| 0x24 | 0x20 | Excursion | 4 / - | 0x00000000 | Generated by GUI |
| 0x28 | 0x20 | Excursion | 4 / - | 0x00000000 | Generated by GUI |
| 0x2C | 0x20 | Excursion | 4 / - | 0x00000000 | Generated by GUI |
| 0x30 | 0x20 | Excursion | 4 / - | 0x00000000 | Generated by GUI |
| 0x34 | 0x20 | Excursion | 4 / - | 0x00000000 | Generated by GUI |
| 0x38 | 0x20 | Excursion | 4 / - | 0x00000000 | Generated by GUI |
| 0x3C | 0x20 | Excursion | 4 / - | 0x00000000 | Generated by GUI |
| 0x40 | 0x20 | Excursion | 4 / - | 0x00000000 | Generated by GUI |
| 0x44 | 0x20 | Excursion | 4 / - | 0x00000000 | Generated by GUI |
| 0x48 | 0x20 | Excursion | 4 / - | 0x00000000 | Generated by GUI |
| 0x4C | 0x20 | Excursion | 4 / - | 0x00000000 | Generated by GUI |
| 0x50 | 0x20 | Excursion | 4 / - | 0x00000000 | Generated by GUI |
| 0x54 | 0x20 | Excursion | 4 / - | 0x00000000 | Generated by GUI |
| 0x58 | 0x20 | Excursion | 4 / - | 0x00000000 | Generated by GUI |
| 0x5C | 0x20 | Excursion | 4 / - | 0x00000000 | Generated by GUI |
| 0x60 | 0x20 | Excursion | 4 / - | 0x00000000 | Generated by GUI |
| 0x64 | 0x20 | Excursion | 4 / - | 0x00000000 | Generated by GUI |
| 0x68 | 0x20 | Excursion | 4 / - | 0x00000000 | Generated by GUI |
| 0x6C | 0x20 | Excursion | 4 / - | 0x7FFFFFFF | Generated by GUI |
| 0x70 | 0x20 | Excursion | 4 / - | 0x00000000 | Generated by GUI |

Table 10. DSP Memory Map for Process Flow 4 — Book 0x8C (continued)

| Sub Address | Page | Register Name | Number of Bytes/Format | Default Value | Description |
|----------------------------------|------|-----------------|------------------------|---------------|---------------------------------------|
| 0x74 | 0x20 | Excursion | 4 / - | 0x00000000 | Generated by GUI |
| 0x78 | 0x20 | Excursion | 4 / - | 0x00000000 | Generated by GUI |
| 0x7C | 0x20 | Excursion | 4 / - | 0x00000000 | Generated by GUI |
| 0x08 | 0x21 | Excursion | 4 / - | 0x7FFFFFFF | Generated by GUI |
| 0x0C | 0x21 | Excursion | 4 / - | 0x00000000 | Generated by GUI |
| 0x10 | 0x21 | Excursion | 4 / - | 0x00000000 | Generated by GUI |
| 0x14 | 0x21 | Excursion | 4 / - | 0x00000000 | Generated by GUI |
| 0x18 | 0x21 | Excursion | 4 / - | 0x00000000 | Generated by GUI |
| MORPHING BQs | | | | | |
| 0x1C | 0x21 | CH-L BQ 1 B0 | 4 / 1.31 | 0x7FFFFFFF | Left Channel Morphing BQ coefficient |
| 0x20 | 0x21 | CH-L BQ 1 B1 | 4 / 2.30 | 0x00000000 | Left Channel Morphing BQ coefficient |
| 0x24 | 0x21 | CH-L BQ 1 B2 | 4 / 1.31 | 0x00000000 | Left Channel Morphing BQ coefficient |
| 0x28 | 0x21 | CH-L BQ 1 A1 | 4 / 2.30 | 0x00000000 | Left Channel Morphing BQ coefficient |
| 0x2C | 0x21 | CH-L BQ 1 A2 | 4 / 1.31 | 0x00000000 | Left Channel Morphing BQ coefficient |
| 0x30 | 0x21 | CH-L BQ 2 B0 | 4 / 1.31 | 0x7FFFFFFF | Left Channel Morphing BQ coefficient |
| 0x34 | 0x21 | CH-L BQ 2 B1 | 4 / 2.30 | 0x00000000 | Left Channel Morphing BQ coefficient |
| 0x38 | 0x21 | CH-L BQ 2 B2 | 4 / 1.31 | 0x00000000 | Left Channel Morphing BQ coefficient |
| 0x3C | 0x21 | CH-L BQ 2 A1 | 4 / 2.30 | 0x00000000 | Left Channel Morphing BQ coefficient |
| 0x40 | 0x21 | CH-L BQ 2 A2 | 4 / 1.31 | 0x00000000 | Left Channel Morphing BQ coefficient |
| 0x44 | 0x21 | CH-R BQ 1 B0 | 4 / 1.31 | 0x7FFFFFFF | Right Channel Morphing BQ coefficient |
| 0x48 | 0x21 | CH-R BQ 1 B1 | 4 / 2.30 | 0x00000000 | Right Channel Morphing BQ coefficient |
| 0x4C | 0x21 | CH-R BQ 1 B2 | 4 / 1.31 | 0x00000000 | Right Channel Morphing BQ coefficient |
| 0x50 | 0x21 | CH-R BQ 1 A1 | 4 / 2.30 | 0x00000000 | Right Channel Morphing BQ coefficient |
| 0x54 | 0x21 | CH-R BQ 1 A2 | 4 / 1.31 | 0x00000000 | Right Channel Morphing BQ coefficient |
| 0x58 | 0x21 | CH-R BQ 2 B0 | 4 / 1.31 | 0x7FFFFFFF | Right Channel Morphing BQ coefficient |
| 0x5C | 0x21 | CH-R BQ 2 B1 | 4 / 2.30 | 0x00000000 | Right Channel Morphing BQ coefficient |
| 0x60 | 0x21 | CH-R BQ 2 B2 | 4 / 1.31 | 0x00000000 | Right Channel Morphing BQ coefficient |
| 0x64 | 0x21 | CH-R BQ 2 A1 | 4 / 2.30 | 0x00000000 | Right Channel Morphing BQ coefficient |
| 0x68 | 0x21 | CH-R BQ 2 A2 | 4 / 1.31 | 0x00000000 | Right Channel Morphing BQ coefficient |
| 0x6C | 0x21 | CH-L Gain scale | 4 / 9.23 | 0x00800000 | Morphing Left Channel Gain |
| 0x70 | 0x21 | CH-R Gain scale | 4 / 9.23 | 0x00800000 | Morphing Right Channel Gain |
| THERMAL PROTECT THRESHOLD | | | | | |
| 0x74 | 0x21 | Thermal | 4 / - | 0x7FFFFFFF | Generated by GUI |

A.5 DSP Memory Map for Process Flow 5

Table 11 lists the DSP memory map for process flow 5.

Table 11. DSP Memory Map for Process Flow 5 — Book 0x8C

| Sub Address | Page | Register Name | Number of Bytes/Format | Default Value | Description |
|---------------------------|------|----------------|------------------------|---------------|-------------------------------|
| CROSS OVER BQs | | | | | |
| 0x58 | 0x11 | BQ 1 B0 | 4 / 1.31 | 0x7FFFFFFF | Cross Over BQ coefficient |
| 0x5C | 0x11 | BQ 1 B1 | 4 / 2.30 | 0x00000000 | Cross Over BQ coefficient |
| 0x60 | 0x11 | BQ 1 B2 | 4 / 1.31 | 0x00000000 | Cross Over BQ coefficient |
| 0x64 | 0x11 | BQ 1 A1 | 4 / 2.30 | 0x00000000 | Cross Over BQ coefficient |
| 0x68 | 0x11 | BQ 1 A2 | 4 / 1.31 | 0x00000000 | Cross Over BQ coefficient |
| 0x6C | 0x11 | BQ 2 B0 | 4 / 1.31 | 0x7FFFFFFF | Cross Over BQ coefficient |
| 0x70 | 0x11 | BQ 2 B1 | 4 / 2.30 | 0x00000000 | Cross Over BQ coefficient |
| 0x74 | 0x11 | BQ 2 B2 | 4 / 1.31 | 0x00000000 | Cross Over BQ coefficient |
| 0x78 | 0x11 | BQ 2 A1 | 4 / 2.30 | 0x00000000 | Cross Over BQ coefficient |
| 0x7C | 0x11 | BQ 2 A2 | 4 / 1.31 | 0x00000000 | Cross Over BQ coefficient |
| 0x08 | 0x12 | BQ 3 B0 | 4 / 1.31 | 0x7FFFFFFF | Cross Over BQ coefficient |
| 0x0C | 0x12 | BQ 3 B1 | 4 / 2.30 | 0x00000000 | Cross Over BQ coefficient |
| 0x10 | 0x12 | BQ 3 B2 | 4 / 1.31 | 0x00000000 | Cross Over BQ coefficient |
| 0x14 | 0x12 | BQ 3 A1 | 4 / 2.30 | 0x00000000 | Cross Over BQ coefficient |
| 0x18 | 0x12 | BQ 3 A2 | 4 / 1.31 | 0x00000000 | Cross Over BQ coefficient |
| 0x1C | 0x12 | BQ 4 B0 | 4 / 1.31 | 0x7FFFFFFF | Cross Over BQ coefficient |
| 0x20 | 0x12 | BQ 4 B1 | 4 / 2.30 | 0x00000000 | Cross Over BQ coefficient |
| 0x24 | 0x12 | BQ 4 B2 | 4 / 1.31 | 0x00000000 | Cross Over BQ coefficient |
| 0x28 | 0x12 | BQ 4 A1 | 4 / 2.30 | 0x00000000 | Cross Over BQ coefficient |
| 0x2C | 0x12 | BQ 4 A2 | 4 / 1.31 | 0x00000000 | Cross Over BQ coefficient |
| 0x30 | 0x12 | BQ 5 B0 | 4 / 1.31 | 0x7FFFFFFF | Cross Over BQ coefficient |
| 0x34 | 0x12 | BQ 5 B1 | 4 / 2.30 | 0x00000000 | Cross Over BQ coefficient |
| 0x38 | 0x12 | BQ 5 B2 | 4 / 1.31 | 0x00000000 | Cross Over BQ coefficient |
| 0x3C | 0x12 | BQ 5 A1 | 4 / 2.30 | 0x00000000 | Cross Over BQ coefficient |
| 0x40 | 0x12 | BQ 5 A2 | 4 / 1.31 | 0x00000000 | Cross Over BQ coefficient |
| SUB CROSS OVER BQs | | | | | |
| 0x44 | 0x12 | CH-Sub BQ 1 B0 | 4 / 1.31 | 0x7FFFFFFF | Sub Cross Over BQ coefficient |
| 0x48 | 0x12 | CH-Sub BQ 1 B1 | 4 / 2.30 | 0x00000000 | Sub Cross Over BQ coefficient |
| 0x4C | 0x12 | CH-Sub BQ 1 B2 | 4 / 1.31 | 0x00000000 | Sub Cross Over BQ coefficient |
| 0x50 | 0x12 | CH-Sub BQ 1 A1 | 4 / 2.30 | 0x00000000 | Sub Cross Over BQ coefficient |
| 0x54 | 0x12 | CH-Sub BQ 1 A2 | 4 / 1.31 | 0x00000000 | Sub Cross Over BQ coefficient |
| 0x58 | 0x12 | CH-Sub BQ 2 B0 | 4 / 1.31 | 0x7FFFFFFF | Sub Cross Over BQ coefficient |
| 0x5C | 0x12 | CH-Sub BQ 2 B1 | 4 / 2.30 | 0x00000000 | Sub Cross Over BQ coefficient |
| 0x60 | 0x12 | CH-Sub BQ 2 B2 | 4 / 1.31 | 0x00000000 | Sub Cross Over BQ coefficient |
| 0x64 | 0x12 | CH-Sub BQ 2 A1 | 4 / 2.30 | 0x00000000 | Sub Cross Over BQ coefficient |
| 0x68 | 0x12 | CH-Sub BQ 2 A2 | 4 / 1.31 | 0x00000000 | Sub Cross Over BQ coefficient |
| 0x6C | 0x12 | CH-Sub BQ 3 B0 | 4 / 1.31 | 0x7FFFFFFF | Sub Cross Over BQ coefficient |
| 0x70 | 0x12 | CH-Sub BQ 3 B1 | 4 / 2.30 | 0x00000000 | Sub Cross Over BQ coefficient |
| 0x74 | 0x12 | CH-Sub BQ 3 B2 | 4 / 1.31 | 0x00000000 | Sub Cross Over BQ coefficient |
| 0x78 | 0x12 | CH-Sub BQ 3 A1 | 4 / 2.30 | 0x00000000 | Sub Cross Over BQ coefficient |
| 0x7C | 0x12 | CH-Sub BQ 3 A2 | 4 / 1.31 | 0x00000000 | Sub Cross Over BQ coefficient |
| 0x08 | 0x13 | CH-Sub BQ 4 B0 | 4 / 1.31 | 0x7FFFFFFF | Sub Cross Over BQ coefficient |
| 0x0C | 0x13 | CH-Sub BQ 4 B1 | 4 / 2.30 | 0x00000000 | Sub Cross Over BQ coefficient |
| 0x10 | 0x13 | CH-Sub BQ 4 B2 | 4 / 1.31 | 0x00000000 | Sub Cross Over BQ coefficient |
| 0x14 | 0x13 | CH-Sub BQ 4 A1 | 4 / 2.30 | 0x00000000 | Sub Cross Over BQ coefficient |
| 0x18 | 0x13 | CH-Sub BQ 4 A2 | 4 / 1.31 | 0x00000000 | Sub Cross Over BQ coefficient |
| 0x1C | 0x13 | CH-Sub BQ 5 B0 | 4 / 1.31 | 0x7FFFFFFF | Sub Cross Over BQ coefficient |

Table 11. DSP Memory Map for Process Flow 5 — Book 0x8C (continued)

| Sub Address | Page | Register Name | Number of Bytes/Format | Default Value | Description |
|----------------------|------|----------------|------------------------|---------------|-------------------------------|
| 0x20 | 0x13 | CH-Sub BQ 5 B1 | 4 / 2.30 | 0x00000000 | Sub Cross Over BQ coefficient |
| 0x24 | 0x13 | CH-Sub BQ 5 B2 | 4 / 1.31 | 0x00000000 | Sub Cross Over BQ coefficient |
| 0x28 | 0x13 | CH-Sub BQ 5 A1 | 4 / 2.30 | 0x00000000 | Sub Cross Over BQ coefficient |
| 0x2C | 0x13 | CH-Sub BQ 5 A2 | 4 / 1.31 | 0x00000000 | Sub Cross Over BQ coefficient |
| DRC 1 BQ | | | | | |
| 0x30 | 0x13 | BQ B0 | 4 / 1.31 | 0x7FFFFFFF | DRC 1 BQ coefficient |
| 0x34 | 0x13 | BQ B1 | 4 / 2.30 | 0x00000000 | DRC 1 BQ coefficient |
| 0x38 | 0x13 | BQ B2 | 4 / 1.31 | 0x00000000 | DRC 1 BQ coefficient |
| 0x3C | 0x13 | BQ A1 | 4 / 2.30 | 0x00000000 | DRC 1 BQ coefficient |
| 0x40 | 0x13 | BQ A2 | 4 / 1.31 | 0x00000000 | DRC 1 BQ coefficient |
| 0x44 | 0x13 | CH-Sub BQ B0 | 4 / 1.31 | 0x7FFFFFFF | Sub DRC 1 BQ coefficient |
| 0x48 | 0x13 | CH-Sub BQ B1 | 4 / 2.30 | 0x00000000 | Sub DRC 1 BQ coefficient |
| 0x4C | 0x13 | CH-Sub BQ B2 | 4 / 1.31 | 0x00000000 | Sub DRC 1 BQ coefficient |
| 0x50 | 0x13 | CH-Sub BQ A1 | 4 / 2.30 | 0x00000000 | Sub DRC 1 BQ coefficient |
| 0x54 | 0x13 | CH-Sub BQ A2 | 4 / 1.31 | 0x00000000 | Sub DRC 1 BQ coefficient |
| DRC 3 BQ | | | | | |
| 0x58 | 0x13 | BQ B0 | 4 / 1.31 | 0x7FFFFFFF | DRC 3 BQ coefficient |
| 0x5C | 0x13 | BQ B1 | 4 / 2.30 | 0x00000000 | DRC 3 BQ coefficient |
| 0x60 | 0x13 | BQ B2 | 4 / 1.31 | 0x00000000 | DRC 3 BQ coefficient |
| 0x64 | 0x13 | BQ A1 | 4 / 2.30 | 0x00000000 | DRC 3 BQ coefficient |
| 0x68 | 0x13 | BQ A2 | 4 / 1.31 | 0x00000000 | DRC 3 BQ coefficient |
| 0x6C | 0x13 | CH-Sub BQ B0 | 4 / 1.31 | 0x7FFFFFFF | Sub DRC 3 BQ coefficient |
| 0x70 | 0x13 | CH-Sub BQ B1 | 4 / 2.30 | 0x00000000 | Sub DRC 3 BQ coefficient |
| 0x74 | 0x13 | CH-Sub BQ B2 | 4 / 1.31 | 0x00000000 | Sub DRC 3 BQ coefficient |
| 0x78 | 0x13 | CH-Sub BQ A1 | 4 / 2.30 | 0x00000000 | Sub DRC 3 BQ coefficient |
| 0x7C | 0x13 | CH-Sub BQ A2 | 4 / 1.31 | 0x00000000 | Sub DRC 3 BQ coefficient |
| DRC 2 BQ | | | | | |
| 0x08 | 0x14 | BQ 1 B0 | 4 / 1.31 | 0x7FFFFFFF | DRC 2 BQ coefficient |
| 0x0C | 0x14 | BQ 1 B1 | 4 / 2.30 | 0x00000000 | DRC 2 BQ coefficient |
| 0x10 | 0x14 | BQ 1 B2 | 4 / 1.31 | 0x00000000 | DRC 2 BQ coefficient |
| 0x14 | 0x14 | BQ 1 A1 | 4 / 2.30 | 0x00000000 | DRC 2 BQ coefficient |
| 0x18 | 0x14 | BQ 1 A2 | 4 / 1.31 | 0x00000000 | DRC 2 BQ coefficient |
| 0x1C | 0x14 | BQ 2 B0 | 4 / 1.31 | 0x7FFFFFFF | DRC 2 BQ coefficient |
| 0x20 | 0x14 | BQ 2 B1 | 4 / 2.30 | 0x00000000 | DRC 2 BQ coefficient |
| 0x24 | 0x14 | BQ 2 B2 | 4 / 1.31 | 0x00000000 | DRC 2 BQ coefficient |
| 0x28 | 0x14 | BQ 2 A1 | 4 / 2.30 | 0x00000000 | DRC 2 BQ coefficient |
| 0x2C | 0x14 | BQ 2 A2 | 4 / 1.31 | 0x00000000 | DRC 2 BQ coefficient |
| 0x30 | 0x14 | CH-Sub BQ 1 B0 | 4 / 1.31 | 0x7FFFFFFF | Sub DRC 2 BQ coefficient |
| 0x34 | 0x14 | CH-Sub BQ 1 B1 | 4 / 2.30 | 0x00000000 | Sub DRC 2 BQ coefficient |
| 0x38 | 0x14 | CH-Sub BQ 1 B2 | 4 / 1.31 | 0x00000000 | Sub DRC 2 BQ coefficient |
| 0x3C | 0x14 | CH-Sub BQ 1 A1 | 4 / 2.30 | 0x00000000 | Sub DRC 2 BQ coefficient |
| 0x40 | 0x14 | CH-Sub BQ 1 A2 | 4 / 1.31 | 0x00000000 | Sub DRC 2 BQ coefficient |
| 0x44 | 0x14 | CH-Sub BQ 2 B0 | 4 / 1.31 | 0x7FFFFFFF | Sub DRC 2 BQ coefficient |
| 0x48 | 0x14 | CH-Sub BQ 2 B1 | 4 / 2.30 | 0x00000000 | Sub DRC 2 BQ coefficient |
| 0x4C | 0x14 | CH-Sub BQ 2 B2 | 4 / 1.31 | 0x00000000 | Sub DRC 2 BQ coefficient |
| 0x50 | 0x14 | CH-Sub BQ 2 A1 | 4 / 2.30 | 0x00000000 | Sub DRC 2 BQ coefficient |
| 0x54 | 0x14 | CH-Sub BQ 2 A2 | 4 / 1.31 | 0x00000000 | Sub DRC 2 BQ coefficient |
| DPEQ SENSE BQ | | | | | |
| 0x58 | 0x14 | BQ 1 B0 | 4 / 1.31 | 0x7FFFFFFF | DPEQ sense BQ coefficient |
| 0x5C | 0x14 | BQ 1 B1 | 4 / 2.30 | 0x00000000 | DPEQ sense BQ coefficient |
| 0x60 | 0x14 | BQ 1 B2 | 4 / 1.31 | 0x00000000 | DPEQ sense BQ coefficient |

Table 11. DSP Memory Map for Process Flow 5 — Book 0x8C (continued)

| Sub Address | Page | Register Name | Number of Bytes/Format | Default Value | Description |
|--------------------------------|------|---------------|------------------------|---------------|---------------------------|
| 0x64 | 0x14 | BQ 1 A1 | 4 / 2.30 | 0x00000000 | DPEQ sense BQ coefficient |
| 0x68 | 0x14 | BQ 1 A2 | 4 / 1.31 | 0x00000000 | DPEQ sense BQ coefficient |
| 0x6C | 0x14 | BQ 2 B0 | 4 / 1.31 | 0x7FFFFFFF | DPEQ sense BQ coefficient |
| 0x70 | 0x14 | BQ 2 B1 | 4 / 2.30 | 0x00000000 | DPEQ sense BQ coefficient |
| 0x74 | 0x14 | BQ 2 B2 | 4 / 1.31 | 0x00000000 | DPEQ sense BQ coefficient |
| 0x78 | 0x14 | BQ 2 A1 | 4 / 2.30 | 0x00000000 | DPEQ sense BQ coefficient |
| 0x7C | 0x14 | BQ 2 A2 | 4 / 1.31 | 0x00000000 | DPEQ sense BQ coefficient |
| DPEQ LOW LEVEL PATH BQ | | | | | |
| 0x08 | 0x15 | BQ 1 B0 | 4 / 1.31 | 0x7FFFFFFF | DPEQ low BQ coefficient |
| 0x0C | 0x15 | BQ 1 B1 | 4 / 2.30 | 0x00000000 | DPEQ low BQ coefficient |
| 0x10 | 0x15 | BQ 1 B2 | 4 / 1.31 | 0x00000000 | DPEQ low BQ coefficient |
| 0x14 | 0x15 | BQ 1 A1 | 4 / 2.30 | 0x00000000 | DPEQ low BQ coefficient |
| 0x18 | 0x15 | BQ 1 A2 | 4 / 1.31 | 0x00000000 | DPEQ low BQ coefficient |
| 0x1C | 0x15 | BQ 2 B0 | 4 / 1.31 | 0x7FFFFFFF | DPEQ low BQ coefficient |
| 0x20 | 0x15 | BQ 2 B1 | 4 / 2.30 | 0x00000000 | DPEQ low BQ coefficient |
| 0x24 | 0x15 | BQ 2 B2 | 4 / 1.31 | 0x00000000 | DPEQ low BQ coefficient |
| 0x28 | 0x15 | BQ 2 A1 | 4 / 2.30 | 0x00000000 | DPEQ low BQ coefficient |
| 0x2C | 0x15 | BQ 2 A2 | 4 / 1.31 | 0x00000000 | DPEQ low BQ coefficient |
| DPEQ HIGH LEVEL PATH BQ | | | | | |
| 0x30 | 0x15 | BQ 1 B0 | 4 / 1.31 | 0x7FFFFFFF | DPEQ high BQ coefficient |
| 0x34 | 0x15 | BQ 1 B1 | 4 / 2.30 | 0x00000000 | DPEQ high BQ coefficient |
| 0x38 | 0x15 | BQ 1 B2 | 4 / 1.31 | 0x00000000 | DPEQ high BQ coefficient |
| 0x3C | 0x15 | BQ 1 A1 | 4 / 2.30 | 0x00000000 | DPEQ high BQ coefficient |
| 0x40 | 0x15 | BQ 1 A2 | 4 / 1.31 | 0x00000000 | DPEQ high BQ coefficient |
| 0x44 | 0x15 | BQ 2 B0 | 4 / 1.31 | 0x7FFFFFFF | DPEQ high BQ coefficient |
| 0x48 | 0x15 | BQ 2 B1 | 4 / 2.30 | 0x00000000 | DPEQ high BQ coefficient |
| 0x4C | 0x15 | BQ 2 B2 | 4 / 1.31 | 0x00000000 | DPEQ high BQ coefficient |
| 0x50 | 0x15 | BQ 2 A1 | 4 / 2.30 | 0x00000000 | DPEQ high BQ coefficient |
| 0x54 | 0x15 | BQ 2 A2 | 4 / 1.31 | 0x00000000 | DPEQ high BQ coefficient |
| EQ LEFT 14 BQs | | | | | |
| 0x58 | 0x15 | CH -L BQ 1 B0 | 4 / 1.31 | 0x7FFFFFFF | Left BQ coefficient |
| 0x5C | 0x15 | CH -L BQ 1 B1 | 4 / 2.30 | 0x00000000 | Left BQ coefficient |
| 0x60 | 0x15 | CH -L BQ 1 B2 | 4 / 1.31 | 0x00000000 | Left BQ coefficient |
| 0x64 | 0x15 | CH -L BQ 1 A1 | 4 / 2.30 | 0x00000000 | Left BQ coefficient |
| 0x68 | 0x15 | CH -L BQ 1 A2 | 4 / 1.31 | 0x00000000 | Left BQ coefficient |
| 0x6C | 0x15 | CH -L BQ 2 B0 | 4 / 1.31 | 0x7FFFFFFF | Left BQ coefficient |
| 0x70 | 0x15 | CH -L BQ 2 B1 | 4 / 2.30 | 0x00000000 | Left BQ coefficient |
| 0x74 | 0x15 | CH -L BQ 2 B2 | 4 / 1.31 | 0x00000000 | Left BQ coefficient |
| 0x78 | 0x15 | CH -L BQ 2 A1 | 4 / 2.30 | 0x00000000 | Left BQ coefficient |
| 0x7C | 0x15 | CH -L BQ 2 A2 | 4 / 1.31 | 0x00000000 | Left BQ coefficient |
| 0x08 | 0x16 | CH -L BQ 3 B0 | 4 / 1.31 | 0x7FFFFFFF | Left BQ coefficient |
| 0x0C | 0x16 | CH -L BQ 3 B1 | 4 / 2.30 | 0x00000000 | Left BQ coefficient |
| 0x10 | 0x16 | CH -L BQ 3 B2 | 4 / 1.31 | 0x00000000 | Left BQ coefficient |
| 0x14 | 0x16 | CH -L BQ 3 A1 | 4 / 2.30 | 0x00000000 | Left BQ coefficient |
| 0x18 | 0x16 | CH -L BQ 3 A2 | 4 / 1.31 | 0x00000000 | Left BQ coefficient |
| 0x1C | 0x16 | CH -L BQ 4 B0 | 4 / 1.31 | 0x7FFFFFFF | Left BQ coefficient |
| 0x20 | 0x16 | CH -L BQ 4 B1 | 4 / 2.30 | 0x00000000 | Left BQ coefficient |
| 0x24 | 0x16 | CH -L BQ 4 B2 | 4 / 1.31 | 0x00000000 | Left BQ coefficient |
| 0x28 | 0x16 | CH -L BQ 4 A1 | 4 / 2.30 | 0x00000000 | Left BQ coefficient |
| 0x2C | 0x16 | CH -L BQ 4 A2 | 4 / 1.31 | 0x00000000 | Left BQ coefficient |
| 0x30 | 0x16 | CH -L BQ 5 B0 | 4 / 1.31 | 0x7FFFFFFF | Left BQ coefficient |

Table 11. DSP Memory Map for Process Flow 5 — Book 0x8C (continued)

| Sub Address | Page | Register Name | Number of Bytes/Format | Default Value | Description |
|------------------------|------|----------------|------------------------|---------------|--------------------------------|
| 0x34 | 0x16 | CH -L BQ 5 B1 | 4 / 2.30 | 0x00000000 | Left BQ coefficient |
| 0x38 | 0x16 | CH -L BQ 5 B2 | 4 / 1.31 | 0x00000000 | Left BQ coefficient |
| 0x3C | 0x16 | CH -L BQ 5 A1 | 4 / 2.30 | 0x00000000 | Left BQ coefficient |
| 0x40 | 0x16 | CH -L BQ 5 A2 | 4 / 1.31 | 0x00000000 | Left BQ coefficient |
| 0x44 | 0x16 | CH -L BQ 6 B0 | 4 / 1.31 | 0x7FFFFFFF | Left BQ coefficient |
| 0x48 | 0x16 | CH -L BQ 6 B1 | 4 / 2.30 | 0x00000000 | Left BQ coefficient |
| 0x4C | 0x16 | CH -L BQ 6 B2 | 4 / 1.31 | 0x00000000 | Left BQ coefficient |
| 0x50 | 0x16 | CH -L BQ 6 A1 | 4 / 2.30 | 0x00000000 | Left BQ coefficient |
| 0x54 | 0x16 | CH -LBQ 6 A2 | 4 / 1.31 | 0x00000000 | Left BQ coefficient |
| 0x58 | 0x16 | CH -L BQ 7 B0 | 4 / 1.31 | 0x7FFFFFFF | Left BQ coefficient |
| 0x5C | 0x16 | CH -L BQ 7 B1 | 4 / 2.30 | 0x00000000 | Left BQ coefficient |
| 0x60 | 0x16 | CH -L BQ 7 B2 | 4 / 1.31 | 0x00000000 | Left BQ coefficient |
| 0x64 | 0x16 | CH -L BQ 7 A1 | 4 / 2.30 | 0x00000000 | Left BQ coefficient |
| 0x68 | 0x16 | CH -L BQ 7 A2 | 4 / 1.31 | 0x00000000 | Left BQ coefficient |
| 0x6C | 0x16 | CH -L BQ 8 B0 | 4 / 1.31 | 0x7FFFFFFF | Left BQ coefficient |
| 0x70 | 0x16 | CH -L BQ 8 B1 | 4 / 2.30 | 0x00000000 | Left BQ coefficient |
| 0x74 | 0x16 | CH -L BQ 8 B2 | 4 / 1.31 | 0x00000000 | Left BQ coefficient |
| 0x78 | 0x16 | CH -L BQ 8 A1 | 4 / 2.30 | 0x00000000 | Left BQ coefficient |
| 0x7C | 0x16 | CH -L BQ 8 A2 | 4 / 1.31 | 0x00000000 | Left BQ coefficient |
| 0x08 | 0x17 | CH -L BQ 9 B0 | 4 / 1.31 | 0x7FFFFFFF | Left BQ coefficient |
| 0x0C | 0x17 | CH -L BQ 9 B1 | 4 / 2.30 | 0x00000000 | Left BQ coefficient |
| 0x10 | 0x17 | CH -L BQ 9 B2 | 4 / 1.31 | 0x00000000 | Left BQ coefficient |
| 0x14 | 0x17 | CH -L BQ 9 A1 | 4 / 2.30 | 0x00000000 | Left BQ coefficient |
| 0x18 | 0x17 | CH -L BQ 9 A2 | 4 / 1.31 | 0x00000000 | Left BQ coefficient |
| 0x1C | 0x17 | CH -L BQ 10 B0 | 4 / 1.31 | 0x7FFFFFFF | Left BQ coefficient |
| 0x20 | 0x17 | CH -L BQ 10 B1 | 4 / 2.30 | 0x00000000 | Left BQ coefficient |
| 0x24 | 0x17 | CH -L BQ 10 B2 | 4 / 1.31 | 0x00000000 | Left BQ coefficient |
| 0x28 | 0x17 | CH -L BQ 10 A1 | 4 / 2.30 | 0x00000000 | Left BQ coefficient |
| 0x2C | 0x17 | CH -L BQ 10 A2 | 4 / 1.31 | 0x00000000 | Left BQ coefficient |
| 0x30 | 0x17 | CH -L BQ 11 B0 | 4 / 1.31 | 0x7FFFFFFF | Left BQ coefficient |
| 0x34 | 0x17 | CH -L BQ 11 B1 | 4 / 2.30 | 0x00000000 | Left BQ coefficient |
| 0x38 | 0x17 | CH -L BQ 11 B2 | 4 / 1.31 | 0x00000000 | Left BQ coefficient |
| 0x3C | 0x17 | CH -L BQ 11 A1 | 4 / 2.30 | 0x00000000 | Left BQ coefficient |
| 0x40 | 0x17 | CH -L BQ 11 A2 | 4 / 1.31 | 0x00000000 | Left BQ coefficient |
| 0x44 | 0x17 | CH -L BQ 12 B0 | 4 / 1.31 | 0x7FFFFFFF | Left BQ coefficient |
| 0x48 | 0x17 | CH -L BQ 12 B1 | 4 / 2.30 | 0x00000000 | Left BQ coefficient |
| 0x4C | 0x17 | CH -L BQ 12 B2 | 4 / 1.31 | 0x00000000 | Left BQ coefficient |
| 0x50 | 0x17 | CH -L BQ 12 A1 | 4 / 2.30 | 0x00000000 | Left BQ coefficient |
| 0x54 | 0x17 | CH -L BQ 12 A2 | 4 / 1.31 | 0x00000000 | Left BQ coefficient |
| 0x58 | 0x17 | CH -L BQ 13 B0 | 4 / 1.31 | 0x7FFFFFFF | Left BQ coefficient |
| 0x5C | 0x17 | CH -L BQ 13 B1 | 4 / 2.30 | 0x00000000 | Left BQ coefficient |
| 0x60 | 0x17 | CH -L BQ 13 B2 | 4 / 1.31 | 0x00000000 | Left BQ coefficient |
| 0x64 | 0x17 | CH -L BQ 13 A1 | 4 / 2.30 | 0x00000000 | Left BQ coefficient |
| 0x68 | 0x17 | CH -L BQ 13 A2 | 4 / 1.31 | 0x00000000 | Left BQ coefficient |
| 0x6C | 0x17 | CH -L BQ 14 B0 | 4 / 1.31 | 0x7FFFFFFF | Left BQ coefficient |
| 0x70 | 0x17 | CH -L BQ 14 B1 | 4 / 2.30 | 0x00000000 | Left BQ coefficient |
| 0x74 | 0x17 | CH -L BQ 14 B2 | 4 / 1.31 | 0x00000000 | Left BQ coefficient |
| 0x78 | 0x17 | CH -L BQ 14 A1 | 4 / 2.30 | 0x00000000 | Left BQ coefficient |
| 0x7C | 0x17 | CH -L BQ 14 A2 | 4 / 1.31 | 0x00000000 | Left BQ coefficient |
| LEFT INTGAIN BQ | | | | | |
| 0x08 | 0x18 | CH -L BQ 15 B0 | 4 / 5.27 | 0x08000000 | Left gain scale BQ coefficient |

Table 11. DSP Memory Map for Process Flow 5 — Book 0x8C (continued)

| Sub Address | Page | Register Name | Number of Bytes/Format | Default Value | Description |
|------------------------|------|----------------|------------------------|---------------|--------------------------------|
| 0x0C | 0x18 | CH -L BQ 15 B1 | 4 / 6.26 | 0x00000000 | Left gain scale BQ coefficient |
| 0x10 | 0x18 | CH -L BQ 15 B2 | 4 / 5.27 | 0x00000000 | Left gain scale BQ coefficient |
| 0x14 | 0x18 | CH -L BQ 15 A1 | 4 / 2.30 | 0x00000000 | Left gain scale BQ coefficient |
| 0x18 | 0x18 | CH -L BQ 15 A2 | 4 / 1.31 | 0x00000000 | Left gain scale BQ coefficient |
| EQ RIGHT 14 BQs | | | | | |
| 0x1C | 0x18 | CH -R BQ 1 B0 | 4 / 1.31 | 0x7FFFFFFF | Right BQ coefficient |
| 0x20 | 0x18 | CH -R BQ 1 B1 | 4 / 2.30 | 0x00000000 | Right BQ coefficient |
| 0x24 | 0x18 | CH -R BQ 1 B2 | 4 / 1.31 | 0x00000000 | Right BQ coefficient |
| 0x28 | 0x18 | CH -R BQ 1 A1 | 4 / 2.30 | 0x00000000 | Right BQ coefficient |
| 0x2C | 0x18 | CH -R BQ 1 A2 | 4 / 1.31 | 0x00000000 | Right BQ coefficient |
| 0x30 | 0x18 | CH -R BQ 2 B0 | 4 / 1.31 | 0x7FFFFFFF | Right BQ coefficient |
| 0x34 | 0x18 | CH -R BQ 2 B1 | 4 / 2.30 | 0x00000000 | Right BQ coefficient |
| 0x38 | 0x18 | CH -R BQ 2 B2 | 4 / 1.31 | 0x00000000 | Right BQ coefficient |
| 0x3C | 0x18 | CH -R BQ 2 A1 | 4 / 2.30 | 0x00000000 | Right BQ coefficient |
| 0x40 | 0x18 | CH -R BQ 2 A2 | 4 / 1.31 | 0x00000000 | Right BQ coefficient |
| 0x44 | 0x18 | CH -R BQ 3 B0 | 4 / 1.31 | 0x7FFFFFFF | Right BQ coefficient |
| 0x48 | 0x18 | CH -R BQ 3 B1 | 4 / 2.30 | 0x00000000 | Right BQ coefficient |
| 0x4C | 0x18 | CH -R BQ 3 B2 | 4 / 1.31 | 0x00000000 | Right BQ coefficient |
| 0x50 | 0x18 | CH -R BQ 3 A1 | 4 / 2.30 | 0x00000000 | Right BQ coefficient |
| 0x54 | 0x18 | CH -R BQ 3 A2 | 4 / 1.31 | 0x00000000 | Right BQ coefficient |
| 0x58 | 0x18 | CH -R BQ 4 B0 | 4 / 1.31 | 0x7FFFFFFF | Right BQ coefficient |
| 0x5C | 0x18 | CH -R BQ 4 B1 | 4 / 2.30 | 0x00000000 | Right BQ coefficient |
| 0x60 | 0x18 | CH -R BQ 4 B2 | 4 / 1.31 | 0x00000000 | Right BQ coefficient |
| 0x64 | 0x18 | CH -R BQ 4 A1 | 4 / 2.30 | 0x00000000 | Right BQ coefficient |
| 0x68 | 0x18 | CH -R BQ 4 A2 | 4 / 1.31 | 0x00000000 | Right BQ coefficient |
| 0x6C | 0x18 | CH -R BQ 5 B0 | 4 / 1.31 | 0x7FFFFFFF | Right BQ coefficient |
| 0x70 | 0x18 | CH -R BQ 5 B1 | 4 / 2.30 | 0x00000000 | Right BQ coefficient |
| 0x74 | 0x18 | CH -R BQ 5 B2 | 4 / 1.31 | 0x00000000 | Right BQ coefficient |
| 0x78 | 0x18 | CH -R BQ 5 A1 | 4 / 2.30 | 0x00000000 | Right BQ coefficient |
| 0x7C | 0x18 | CH -R BQ 5 A2 | 4 / 1.31 | 0x00000000 | Right BQ coefficient |
| 0x08 | 0x19 | CH -R BQ 6 B0 | 4 / 1.31 | 0x7FFFFFFF | Right BQ coefficient |
| 0x0C | 0x19 | CH -R BQ 6 B1 | 4 / 2.30 | 0x00000000 | Right BQ coefficient |
| 0x10 | 0x19 | CH -R BQ 6 B2 | 4 / 1.31 | 0x00000000 | Right BQ coefficient |
| 0x14 | 0x19 | CH -R BQ 6 A1 | 4 / 2.30 | 0x00000000 | Right BQ coefficient |
| 0x18 | 0x19 | CH -R BQ 6 A2 | 4 / 1.31 | 0x00000000 | Right BQ coefficient |
| 0x1C | 0x19 | CH -R BQ 7 B0 | 4 / 1.31 | 0x7FFFFFFF | Right BQ coefficient |
| 0x20 | 0x19 | CH -R BQ 7 B1 | 4 / 2.30 | 0x00000000 | Right BQ coefficient |
| 0x24 | 0x19 | CH -R BQ 7 B2 | 4 / 1.31 | 0x00000000 | Right BQ coefficient |
| 0x28 | 0x19 | CH -R BQ 7 A1 | 4 / 2.30 | 0x00000000 | Right BQ coefficient |
| 0x2C | 0x19 | CH -R BQ 7 A2 | 4 / 1.31 | 0x00000000 | Right BQ coefficient |
| 0x30 | 0x19 | CH -R BQ 8 B0 | 4 / 1.31 | 0x7FFFFFFF | Right BQ coefficient |
| 0x34 | 0x19 | CH -R BQ 8 B1 | 4 / 2.30 | 0x00000000 | Right BQ coefficient |
| 0x38 | 0x19 | CH -R BQ 8 B2 | 4 / 1.31 | 0x00000000 | Right BQ coefficient |
| 0x3C | 0x19 | CH -R BQ 8 A1 | 4 / 2.30 | 0x00000000 | Right BQ coefficient |
| 0x40 | 0x19 | CH -R BQ 8 A2 | 4 / 1.31 | 0x00000000 | Right BQ coefficient |
| 0x44 | 0x19 | CH -R BQ 9 B0 | 4 / 1.31 | 0x7FFFFFFF | Right BQ coefficient |
| 0x48 | 0x19 | CH -R BQ 9 B1 | 4 / 2.30 | 0x00000000 | Right BQ coefficient |
| 0x4C | 0x19 | CH -R BQ 9 B2 | 4 / 1.31 | 0x00000000 | Right BQ coefficient |
| 0x50 | 0x19 | CH -R BQ 9 A1 | 4 / 2.30 | 0x00000000 | Right BQ coefficient |
| 0x54 | 0x19 | CH -R BQ 9 A2 | 4 / 1.31 | 0x00000000 | Right BQ coefficient |
| 0x58 | 0x19 | CH -R BQ 10 B0 | 4 / 1.31 | 0x7FFFFFFF | Right BQ coefficient |

Table 11. DSP Memory Map for Process Flow 5 — Book 0x8C (continued)

| Sub Address | Page | Register Name | Number of Bytes/Format | Default Value | Description |
|---|------|------------------------|------------------------|---------------|---------------------------------|
| 0x5C | 0x19 | CH -R BQ 10 B1 | 4 / 2.30 | 0x00000000 | Right BQ coefficient |
| 0x60 | 0x19 | CH -R BQ 10 B2 | 4 / 1.31 | 0x00000000 | Right BQ coefficient |
| 0x64 | 0x19 | CH -R BQ 10 A1 | 4 / 2.30 | 0x00000000 | Right BQ coefficient |
| 0x68 | 0x19 | CH -R BQ 10 A2 | 4 / 1.31 | 0x00000000 | Right BQ coefficient |
| 0x6C | 0x19 | CH -R BQ 11 B0 | 4 / 1.31 | 0x7FFFFFFF | Right BQ coefficient |
| 0x70 | 0x19 | CH -R BQ 11 B1 | 4 / 2.30 | 0x00000000 | Right BQ coefficient |
| 0x74 | 0x19 | CH -R BQ 11 B2 | 4 / 1.31 | 0x00000000 | Right BQ coefficient |
| 0x78 | 0x19 | CH -R BQ 11 A1 | 4 / 2.30 | 0x00000000 | Right BQ coefficient |
| 0x7C | 0x19 | CH -R BQ 11 A2 | 4 / 1.31 | 0x00000000 | Right BQ coefficient |
| 0x08 | 0x1A | CH -R BQ 12 B0 | 4 / 1.31 | 0x7FFFFFFF | Right BQ coefficient |
| 0x0C | 0x1A | CH -R BQ 12 B1 | 4 / 2.30 | 0x00000000 | Right BQ coefficient |
| 0x10 | 0x1A | CH -R BQ 12 B2 | 4 / 1.31 | 0x00000000 | Right BQ coefficient |
| 0x14 | 0x1A | CH -R BQ 12 A1 | 4 / 2.30 | 0x00000000 | Right BQ coefficient |
| 0x18 | 0x1A | CH -R BQ 12 A2 | 4 / 1.31 | 0x00000000 | Right BQ coefficient |
| 0x1C | 0x1A | CH -R BQ 13 B0 | 4 / 1.31 | 0x7FFFFFFF | Right BQ coefficient |
| 0x20 | 0x1A | CH -R BQ 13 B1 | 4 / 2.30 | 0x00000000 | Right BQ coefficient |
| 0x24 | 0x1A | CH -R BQ 13 B2 | 4 / 1.31 | 0x00000000 | Right BQ coefficient |
| 0x28 | 0x1A | CH -R BQ 13 A1 | 4 / 2.30 | 0x00000000 | Right BQ coefficient |
| 0x2C | 0x1A | CH -R BQ 13 A2 | 4 / 1.31 | 0x00000000 | Right BQ coefficient |
| 0x30 | 0x1A | CH -R BQ 14 B0 | 4 / 1.31 | 0x7FFFFFFF | Right BQ coefficient |
| 0x34 | 0x1A | CH -R BQ 14 B1 | 4 / 2.30 | 0x00000000 | Right BQ coefficient |
| 0x38 | 0x1A | CH -R BQ 14 B2 | 4 / 1.31 | 0x00000000 | Right BQ coefficient |
| 0x3C | 0x1A | CH -R BQ 14 A1 | 4 / 2.30 | 0x00000000 | Right BQ coefficient |
| 0x40 | 0x1A | CH -R BQ 14 A2 | 4 / 1.31 | 0x00000000 | Right BQ coefficient |
| RIGHT INTGAIN BQ | | | | | |
| 0x44 | 0x1A | CH -R BQ 15 B0 | 4 / 5.27 | 0x08000000 | Right gain scale BQ coefficient |
| 0x48 | 0x1A | CH -R BQ 15 B1 | 4 / 6.26 | 0x00000000 | Right gain scale BQ coefficient |
| 0x4C | 0x1A | CH -R BQ 15 B2 | 4 / 5.27 | 0x00000000 | Right gain scale BQ coefficient |
| 0x50 | 0x1A | CH -R BQ 15 A1 | 4 / 2.30 | 0x00000000 | Right gain scale BQ coefficient |
| 0x54 | 0x1A | CH -R BQ 15 A2 | 4 / 1.31 | 0x00000000 | Right gain scale BQ coefficient |
| VOLUME ALPHA FILTER | | | | | |
| 0x58 | 0x1A | Softening Filter Alpha | 4 / 1.31 | 0x00A7264A | Volume time constant |
| PHASE OPTIMIZER | | | | | |
| 0x60 0x1A Delay Left 4 / 32.0 0x00000000 Left Channel Phase Optimizer | | | | | |
| 0x64 | 0x1A | Delay Right | 4 / 32.0 | 0x00000000 | Right Channel Phase Optimizer |
| 0x68 | 0x1A | Delay Sub | 4 / 32.0 | 0x00000000 | Sub Channel Phase Optimizer |
| MAIN DRC 1 | | | | | |
| 0x6C | 0x1A | DRC1 Energy | 4 / 1.31 | 0x7FFFFFFF | DRC1 Energy Time constant |
| 0x70 | 0x1A | DRC1 Attack | 4 / 1.31 | 0x7FFFFFFF | DRC1 Attack Time constant |
| 0x74 | 0x1A | DRC1 Decay | 4 / 1.31 | 0x7FFFFFFF | DRC1 Decay Time constant |
| 0x78 | 0x1A | K0_1 | 4 / 9.23 | 0x00000000 | DRC1 Region 1 Slope (comp/Exp) |
| 0x7C | 0x1A | K1_1 | 4 / 9.23 | 0x00000000 | DRC1 Region 2 Slope (comp/Exp) |
| 0x08 | 0x1B | K2_1 | 4 / 9.23 | 0x00000000 | DRC1 Region 3 Slope (comp/Exp) |
| 0x0C | 0x1B | T1_1 | 4 / 9.23 | 0xE7000000 | DRC1 Threshold 1 |
| 0x10 | 0x1B | T2_1 | 4 / 9.23 | 0xFE800000 | DRC1 Threshold 2 |
| 0x14 | 0x1B | off1_1 | 4 / 9.23 | 0x00000000 | DRC1 Offset 1 |
| 0x18 | 0x1B | off2_1 | 4 / 9.23 | 0x00000000 | DRC1 Offset 2 |
| MAIN DRC 2 | | | | | |
| 0x1C | 0x1B | DRC2 Energy | 4 / 1.31 | 0x7FFFFFFF | DRC2 Energy Time constant |
| 0x20 | 0x1B | DRC2 Attack | 4 / 1.31 | 0x7FFFFFFF | DRC2 Attack Time constant |
| 0x24 | 0x1B | DRC2 Decay | 4 / 1.31 | 0x7FFFFFFF | DRC2 Decay Time constant |

Table 11. DSP Memory Map for Process Flow 5 — Book 0x8C (continued)

| Sub Address | Page | Register Name | Number of Bytes/Format | Default Value | Description |
|-------------------|------|--------------------|------------------------|---------------|--|
| 0x28 | 0x1B | k0_2 | 4 / 9.23 | 0x00000000 | DRC2 Region 1 Slope (comp/Exp) |
| 0x2C | 0x1B | k1_2 | 4 / 9.23 | 0x00000000 | DRC2 Region 2 Slope (comp/Exp) |
| 0x30 | 0x1B | k2_2 | 4 / 9.23 | 0x00000000 | DRC2 Region 3 Slope (comp/Exp) |
| 0x34 | 0x1B | t1_2 | 4 / 9.23 | 0xE7000000 | DRC2 Threshold 1 |
| 0x38 | 0x1B | t2_2 | 4 / 9.23 | 0xFE800000 | DRC2 Threshold 2 |
| 0x3C | 0x1B | off1_2 | 4 / 9.23 | 0x00000000 | DRC2 Offset 1 |
| 0x40 | 0x1B | off2_2 | 4 / 9.23 | 0x00000000 | DRC2 Offset 2 |
| MAIN DRC 3 | | | | | |
| 0x44 | 0x1B | DRC3 Energy | 4 / 1.31 | 0x7FFFFFFF | DRC3 Energy Time constant |
| 0x48 | 0x1B | DRC3 Attack | 4 / 1.31 | 0x7FFFFFFF | DRC3 Attack Time constant |
| 0x4C | 0x1B | DRC3 Decay | 4 / 1.31 | 0x7FFFFFFF | DRC3 Decay Time constant |
| 0x50 | 0x1B | k0_3 | 4 / 9.23 | 0x00000000 | DRC3 Region 1 Slope (comp/Exp) |
| 0x54 | 0x1B | k1_3 | 4 / 9.23 | 0x00000000 | DRC3 Region 2 Slope (comp/Exp) |
| 0x58 | 0x1B | k1_3 | 4 / 9.23 | 0x00000000 | DRC3 Region 3 Slope (comp/Exp) |
| 0x5C | 0x1B | t1_3 | 4 / 9.23 | 0xE7000000 | DRC3 Threshold 1 |
| 0x60 | 0x1B | t2_3 | 4 / 9.23 | 0xFE800000 | DRC3 Threshold 2 |
| 0x64 | 0x1B | off1_3 | 4 / 9.23 | 0x00000000 | DRC3 Offset 1 |
| 0x68 | 0x1B | off2_3 | 4 / 9.23 | 0x00000000 | DRC3 Offset 2 |
| SUB DRC 1 | | | | | |
| 0x6C | 0x1B | CH-Sub DRC1 Energy | 4 / 1.31 | 0x7FFFFFFF | Sub Channel DRC1 Energy Time constant |
| 0x70 | 0x1B | CH-Sub DRC1 Attack | 4 / 1.31 | 0x7FFFFFFF | Sub Channel DRC1 Attack Time constant |
| 0x74 | 0x1B | CH-Sub DRC1 Decay | 4 / 1.31 | 0x7FFFFFFF | Sub Channel DRC1 Decay Time constant |
| 0x78 | 0x1B | CH-Sub K0_1 | 4 / 9.23 | 0x00000000 | Sub Channel DRC1 Region 1 Slope (comp/Exp) |
| 0x7C | 0x1B | CH-Sub K1_1 | 4 / 9.23 | 0x00000000 | Sub Channel DRC1 Region 2 Slope (comp/Exp) |
| 0x08 | 0x1C | CH-Sub K2_1 | 4 / 9.23 | 0x00000000 | Sub Channel DRC1 Region 3 Slope (comp/Exp) |
| 0x0C | 0x1C | CH-Sub T1_1 | 4 / 9.23 | 0xE7000000 | Sub Channel DRC1 Threshold 1 |
| 0x10 | 0x1C | CH-Sub T2_1 | 4 / 9.23 | 0xFE800000 | Sub Channel DRC1 Threshold 2 |
| 0x14 | 0x1C | CH-Sub off1_1 | 4 / 9.23 | 0x00000000 | Sub Channel DRC1 Offset 1 |
| 0x18 | 0x1C | CH-Sub off2_1 | 4 / 9.23 | 0x00000000 | Sub Channel DRC1 Offset 2 |
| SUB DRC 2 | | | | | |
| 0x1C | 0x1C | CH-Sub DRC2 Energy | 4 / 1.31 | 0x7FFFFFFF | Sub Channel DRC2 Energy Time constant |
| 0x20 | 0x1C | CH-Sub DRC2 Attack | 4 / 1.31 | 0x7FFFFFFF | Sub Channel DRC2 Attack Time constant |
| 0x24 | 0x1C | CH-Sub DRC2 Decay | 4 / 1.31 | 0x7FFFFFFF | Sub Channel DRC2 Decay Time constant |
| 0x28 | 0x1C | CH-Sub k0_2 | 4 / 9.23 | 0x00000000 | Sub Channel DRC2 Region 1 Slope (comp/Exp) |
| 0x2C | 0x1C | CH-Sub k1_2 | 4 / 9.23 | 0x00000000 | Sub Channel DRC2 Region 2 Slope (comp/Exp) |
| 0x30 | 0x1C | CH-Sub k2_2 | 4 / 9.23 | 0x00000000 | Sub Channel DRC2 Region 3 Slope (comp/Exp) |
| 0x34 | 0x1C | CH-Sub t1_2 | 4 / 9.23 | 0xE7000000 | Sub Channel DRC2 Threshold 1 |
| 0x38 | 0x1C | CH-Sub t2_2 | 4 / 9.23 | 0xFE800000 | Sub Channel DRC2 Threshold 2 |
| 0x3C | 0x1C | CH-Sub off1_2 | 4 / 9.23 | 0x00000000 | Sub Channel DRC2 Offset 1 |
| 0x40 | 0x1C | CH-Sub off2_2 | 4 / 9.23 | 0x00000000 | Sub Channel DRC2 Offset 2 |
| SUB DRC 3 | | | | | |
| 0x44 | 0x1C | CH-Sub DRC3 Energy | 4 / 1.31 | 0x7FFFFFFF | Sub Channel DRC3 Energy Time constant |
| 0x48 | 0x1C | CH-Sub DRC3 Attack | 4 / 1.31 | 0x7FFFFFFF | Sub Channel DRC3 Attack Time constant |
| 0x4C | 0x1C | CH-Sub DRC3 Decay | 4 / 1.31 | 0x7FFFFFFF | Sub Channel DRC3 Decay Time constant |
| 0x50 | 0x1C | CH-Sub k0_3 | 4 / 9.23 | 0x00000000 | Sub Channel DRC3 Region 1 Slope (comp/Exp) |

Table 11. DSP Memory Map for Process Flow 5 — Book 0x8C (continued)

| Sub Address | Page | Register Name | Number of Bytes/Format | Default Value | Description |
|----------------------------|------|-------------------------|------------------------|---------------|--|
| 0x54 | 0x1C | CH-Sub k1_3 | 4 / 9.23 | 0x00000000 | Sub Channel DRC1 Region 2 Slope (comp/Exp) |
| 0x58 | 0x1C | CH-Sub k1_3 | 4 / 9.23 | 0x00000000 | Sub Channel DRC3 Region 3 Slope (comp/Exp) |
| 0x5C | 0x1C | CH-Sub t1_3 | 4 / 9.23 | 0xE7000000 | Sub Channel DRC3 Threshold 1 |
| 0x60 | 0x1C | CH-Sub t2_3 | 4 / 9.23 | 0xFE800000 | Sub Channel DRC3 Threshold 2 |
| 0x64 | 0x1C | CH-Sub off1_3 | 4 / 9.23 | 0x00000000 | Sub Channel DRC3 Offset 1 |
| 0x68 | 0x1C | CH-Sub off2_3 | 4 / 9.23 | 0x00000000 | Sub Channel DRC3 Offset 2 |
| SPATIALIZER BQs | | | | | |
| 0x6C | 0x1C | BQ 1 B0 | 4 / 1.31 | 0x7FFFFFFF | Spatializer BQ coefficient |
| 0x70 | 0x1C | BQ 1 B1 | 4 / 2.30 | 0x00000000 | Spatializer BQ coefficient |
| 0x74 | 0x1C | BQ 1 B2 | 4 / 1.31 | 0x00000000 | Spatializer BQ coefficient |
| 0x78 | 0x1C | BQ 1 A1 | 4 / 2.30 | 0x00000000 | Spatializer BQ coefficient |
| 0x7C | 0x1C | BQ 1 A2 | 4 / 1.31 | 0x00000000 | Spatializer BQ coefficient |
| 0x08 | 0x1D | BQ 2 B0 | 4 / 1.31 | 0x7FFFFFFF | Spatializer BQ coefficient |
| 0x0C | 0x1D | BQ 2 B1 | 4 / 2.30 | 0x00000000 | Spatializer BQ coefficient |
| 0x10 | 0x1D | BQ 2 B2 | 4 / 1.31 | 0x00000000 | Spatializer BQ coefficient |
| 0x14 | 0x1D | BQ 2 A1 | 4 / 2.30 | 0x00000000 | Spatializer BQ coefficient |
| 0x18 | 0x1D | BQ 2 A2 | 4 / 1.31 | 0x00000000 | Spatializer BQ coefficient |
| DPEQ CONTROL | | | | | |
| 0x1C | 0x1D | Alpha | 4 / 1.31 | 0x02DEAD00 | DPEQ Sense Energy |
| Time constant | | | | | |
| 0x20 | 0x1D | Gain | 4 / 1.31 | 0x74013901 | DPEQ Threshold Gain |
| 0x24 | 0x1D | Offset | 4 / 1.31 | 0x0020C49B | DPEQ Threshold Offset |
| SUB CHANNEL CONTROL | | | | | |
| 0x28 | 0x1D | No Sub | 4 / 32.0 | 0x00000000 | Sub Channel Flag |
| THD CLIPPER | | | | | |
| 0x2C | 0x1D | CH-LR THD Boost | 4 / 9.23 | 0x00800000 | THD LR Channel prescale coefficient |
| 0x30 | 0x1D | CH-Sub THD Boost | 4 / 9.23 | 0x00800000 | THD Sub Channel prescale coefficient |
| 0x34 | 0x1D | CH-L Fine Volume | 4 / 2.30 | 0x3FFFFFFF | THD L Channel postscale coefficient |
| 0x38 | 0x1D | CH-R Fine Volume | 4 / 2.30 | 0x3FFFFFFF | THD R Channel postscale coefficient |
| 0x3C | 0x1D | CH-Sub Fine Volume | 4 / 2.30 | 0x3FFFFFFF | THD Sub Channel postscale coefficient |
| DRC MIXER GAIN | | | | | |
| 0x40 | 0x1D | DRC 1 Mixer Gain | 4 / 9.23 | 0x00800000 | DRC 1 Mixer Gain coefficient |
| 0x44 | 0x1D | DRC 2 Mixer Gain | 4 / 9.23 | 0x00000000 | DRC 2 Mixer Gain coefficient |
| 0x48 | 0x1D | DRC 3 Mixer Gain | 4 / 9.23 | 0x00000000 | DRC 3 Mixer Gain coefficient |
| 0x4C | 0x1D | CH-Sub DRC 1 Mixer Gain | 4 / 9.23 | 0x00800000 | CH-Sub DRC 1 Mixer Gain coefficient |
| 0x50 | 0x1D | CH-Sub DRC 2 Mixer Gain | 4 / 9.23 | 0x00000000 | CH-Sub DRC 2 Mixer Gain coefficient |
| 0x54 | 0x1D | CH-Sub DRC 3 Mixer Gain | 4 / 9.23 | 0x00000000 | CH-Sub DRC 3 Mixer Gain coefficient |
| GANG EQ | | | | | |
| 0x58 | 0x1D | Gang LR EQ | 4 / 32.0 | 0x00000000 | Gang Left and Right EQ flag |
| INPUT MIXER | | | | | |
| 0x5C | 0x1D | Left to Left | 4 / 9.23 | 0x00800000 | Left Channel Mixer Left Input Gain |
| 0x60 | 0x1D | Right to Left | 4 / 9.23 | 0x00000000 | Left Channel Mixer Right |
| 0x64 | 0x1D | Left to Right | 4 / 9.23 | 0x00000000 | Right Channel Mixer Left |
| 0x68 | 0x1D | Right to Right | 4 / 9.23 | 0x00800000 | Right Channel Mixer Right Input Gain |
| MIX/GAIN ADJUST | | | | | |
| 0x6C | 0x1D | Left to Sub | 4 / 9.23 | 0x00000000 | Sub Channel Mixer Left Input Gain |
| 0x70 | 0x1D | Right to Sub | 4 / 9.23 | 0x00000000 | Sub Channel Mixer Right Input Gain |
| 0x74 | 0x1D | Sub Mix ScratchL | 4 / 9.23 | 0x00800000 | Sub Channel Mixer ScratchL Input Gain |
| 0x78 | 0x1D | Sub Mix ScratchR | 4 / 9.23 | 0x00000000 | Sub Channel Mixer ScratchR Input Gain |

Table 11. DSP Memory Map for Process Flow 5 — Book 0x8C (continued)

| Sub Address | Page | Register Name | Number of Bytes/Format | Default Value | Description |
|--------------------------|------|-------------------------------|------------------------|---------------|---------------------------------------|
| 0x7C | 0x1D | Bass Mono Left | 4 / 9.23 | 0x00800000 | Mono Left Input Gain |
| 0x08 | 0x1E | Bass Mono Right | 4 / 9.23 | 0x00800000 | Mono Right Input Gain |
| 0x0C | 0x1E | Bass Mono Sub | 4 / 9.23 | 0x00000000 | Mono Sub Input Gain |
| SPATIALIZER LEVEL | | | | | |
| 0x10 | 0x1E | Spatializer Level | 4 / 9.23 | 0x00000000 | Spatializer Level coefficient |
| OUTPUT CROSS BAR | | | | | |
| 0x14 | 0x1E | Digital Left from Left | 4 / 9.23 | 0x00800000 | I2S Left output gain from left |
| 0x18 | 0x1E | Digital Left from Right | 4 / 9.23 | 0x00000000 | I2S Left output gain from Right |
| 0x1C | 0x1E | Digital Left from Sub | 4 / 9.23 | 0x00000000 | I2S Left output gain from Sub |
| 0x20 | 0x1E | Digital Right from Left | 4 / 9.23 | 0x00000000 | I2S Right output gain from left |
| 0x24 | 0x1E | Digital Right from Right | 4 / 9.23 | 0x00800000 | I2S Right output gain from Right |
| 0x28 | 0x1E | Digital Right from Sub | 4 / 9.23 | 0x00000000 | I2S Right output gain from Sub |
| 0x2C | 0x1E | Analog Left from Left | 4 / 9.23 | 0x00800000 | Analog Left output gain from left |
| 0x30 | 0x1E | Analog Left from Right | 4 / 9.23 | 0x00000000 | Analog Left output gain from Right |
| 0x34 | 0x1E | Analog Left from Sub | 4 / 9.23 | 0x00000000 | Analog Left output gain from Sub |
| 0x38 | 0x1E | Analog Right from Left | 4 / 9.23 | 0x00000000 | Analog Right output gain from left |
| 0x3C | 0x1E | Analog Right from Right | 4 / 9.23 | 0x00800000 | Analog Right output gain from Right |
| 0x40 | 0x1E | Analog Right from Sub | 4 / 9.23 | 0x00000000 | Analog Right output gain from Sub |
| VOLUME CONTROL | | | | | |
| 0x44 | 0x1E | CH-L Volume | 4 / 9.23 | 0x00800000 | Left Channel volume coefficient |
| 0x48 | 0x1E | CH-R Volume | 4 / 9.23 | 0x00800000 | Right Channel volume coefficient |
| 0x4C | 0x1E | CH-Sub Volume | 4 / 9.23 | 0x00800000 | Sub Channel volume coefficient |
| DPEQ GAIN SCALE | | | | | |
| 0x50 | 0x1E | DPEQ Sense Scale | 4 / 2.30 | 0x40000000 | DPEQ Sense Input Gain |
| 0x54 | 0x1E | DPEQ Low Scale | 4 / 6.26 | 0x04000000 | DPEQ Low Input Gain |
| 0x58 | 0x1E | DPEQ High Scale | 4 / 6.26 | 0x04000000 | DPEQ High Input Gain |
| AGL | | | | | |
| 0x6C | 0x1E | CH-Sub Attack Threshold | 4 / 1.31 | 0x40000000 | Sub Channel Threshold linear |
| 0x70 | 0x1E | CH-Sub Softening Filter Alpha | 4 / 1.31 | 0x06153BD1 | Sub Channel AGL Alpha Time constant |
| 0x74 | 0x1E | CH-Sub Attack Rate | 4 / 1.31 | 0x0001B4E8 | Sub Channel AGL Attack Time constant |
| 0x78 | 0x1E | CH-Sub AGL Enable | 4 / 1.31 | 0x40000000 | Sub Channel AGL Enable flag |
| 0x08 | 0x1F | CH-Sub Softening Filter Omega | 4 / 1.31 | 0x79EAC42F | Sub Channel AGL Omega Time constant |
| 0x0C | 0x1F | CH-Sub Release Rate | 4 / 1.31 | 0x00002BB1 | Sub Channel AGL Release Time constant |
| 0x14 | 0x1F | Attack Threshold | 4 / 1.31 | 0x40000000 | Threshold linear |
| 0x18 | 0x1F | Softening Filter Alpha | 4 / 1.31 | 0x06153BD1 | AGL Alpha Time constant |
| 0x1C | 0x1F | Attack Rate | 4 / 1.31 | 0x0001B4E8 | AGL Attack Time constant |
| 0x20 | 0x1F | AGL Enable | 4 / 1.31 | 0x40000000 | AGL Enable flag |
| 0x28 | 0x1F | Softening Filter Omega | 4 / 1.31 | 0x79EAC42F | AGL Omega Time constant |
| 0x2C | 0x1F | Release Rate | 4 / 1.31 | 0x00002BB1 | AGL Release Time constant |

A.6 DSP Memory Map for Process Flow 6

Table 12 lists the DSP memory map for process flow 6.

Table 12. DSP Memory Map for Process Flow 6 — Book 0x8C

| Sub Address | Page | Register Name | Number of Bytes/Format | Default Value | Description |
|---------------------------|------|----------------|------------------------|---------------|-------------------------------|
| CROSS OVER BQs | | | | | |
| 0x58 | 0x11 | BQ 1 B0 | 4 / 1.31 | 0x7FFFFFFF | Cross Over BQ coefficient |
| 0x5C | 0x11 | BQ 1 B1 | 4 / 2.30 | 0x00000000 | Cross Over BQ coefficient |
| 0x60 | 0x11 | BQ 1 B2 | 4 / 1.31 | 0x00000000 | Cross Over BQ coefficient |
| 0x64 | 0x11 | BQ 1 A1 | 4 / 2.30 | 0x00000000 | Cross Over BQ coefficient |
| 0x68 | 0x11 | BQ 1 A2 | 4 / 1.31 | 0x00000000 | Cross Over BQ coefficient |
| 0x6C | 0x11 | BQ 2 B0 | 4 / 1.31 | 0x7FFFFFFF | Cross Over BQ coefficient |
| 0x70 | 0x11 | BQ 2 B1 | 4 / 2.30 | 0x00000000 | Cross Over BQ coefficient |
| 0x74 | 0x11 | BQ 2 B2 | 4 / 1.31 | 0x00000000 | Cross Over BQ coefficient |
| 0x78 | 0x11 | BQ 2 A1 | 4 / 2.30 | 0x00000000 | Cross Over BQ coefficient |
| 0x7C | 0x11 | BQ 2 A2 | 4 / 1.31 | 0x00000000 | Cross Over BQ coefficient |
| 0x08 | 0x12 | BQ 3 B0 | 4 / 1.31 | 0x7FFFFFFF | Cross Over BQ coefficient |
| 0x0C | 0x12 | BQ 3 B1 | 4 / 2.30 | 0x00000000 | Cross Over BQ coefficient |
| 0x10 | 0x12 | BQ 3 B2 | 4 / 1.31 | 0x00000000 | Cross Over BQ coefficient |
| 0x14 | 0x12 | BQ 3 A1 | 4 / 2.30 | 0x00000000 | Cross Over BQ coefficient |
| 0x18 | 0x12 | BQ 3 A2 | 4 / 1.31 | 0x00000000 | Cross Over BQ coefficient |
| 0x1C | 0x12 | BQ 4 B0 | 4 / 1.31 | 0x7FFFFFFF | Cross Over BQ coefficient |
| 0x20 | 0x12 | BQ 4 B1 | 4 / 2.30 | 0x00000000 | Cross Over BQ coefficient |
| 0x24 | 0x12 | BQ 4 B2 | 4 / 1.31 | 0x00000000 | Cross Over BQ coefficient |
| 0x28 | 0x12 | BQ 4 A1 | 4 / 2.30 | 0x00000000 | Cross Over BQ coefficient |
| 0x2C | 0x12 | BQ 4 A2 | 4 / 1.31 | 0x00000000 | Cross Over BQ coefficient |
| 0x30 | 0x12 | BQ 5 B0 | 4 / 1.31 | 0x7FFFFFFF | Cross Over BQ coefficient |
| 0x34 | 0x12 | BQ 5 B1 | 4 / 2.30 | 0x00000000 | Cross Over BQ coefficient |
| 0x38 | 0x12 | BQ 5 B2 | 4 / 1.31 | 0x00000000 | Cross Over BQ coefficient |
| 0x3C | 0x12 | BQ 5 A1 | 4 / 2.30 | 0x00000000 | Cross Over BQ coefficient |
| 0x40 | 0x12 | BQ 5 A2 | 4 / 1.31 | 0x00000000 | Cross Over BQ coefficient |
| SUB CROSS OVER BQs | | | | | |
| 0x44 | 0x12 | CH-Sub BQ 1 B0 | 4 / 1.31 | 0x7FFFFFFF | Sub Cross Over BQ coefficient |
| 0x48 | 0x12 | CH-Sub BQ 1 B1 | 4 / 2.30 | 0x00000000 | Sub Cross Over BQ coefficient |
| 0x4C | 0x12 | CH-Sub BQ 1 B2 | 4 / 1.31 | 0x00000000 | Sub Cross Over BQ coefficient |
| 0x50 | 0x12 | CH-Sub BQ 1 A1 | 4 / 2.30 | 0x00000000 | Sub Cross Over BQ coefficient |
| 0x54 | 0x12 | CH-Sub BQ 1 A2 | 4 / 1.31 | 0x00000000 | Sub Cross Over BQ coefficient |
| 0x58 | 0x12 | CH-Sub BQ 2 B0 | 4 / 1.31 | 0x7FFFFFFF | Sub Cross Over BQ coefficient |
| 0x5C | 0x12 | CH-Sub BQ 2 B1 | 4 / 2.30 | 0x00000000 | Sub Cross Over BQ coefficient |
| 0x60 | 0x12 | CH-Sub BQ 2 B2 | 4 / 1.31 | 0x00000000 | Sub Cross Over BQ coefficient |
| 0x64 | 0x12 | CH-Sub BQ 2 A1 | 4 / 2.30 | 0x00000000 | Sub Cross Over BQ coefficient |
| 0x68 | 0x12 | CH-Sub BQ 2 A2 | 4 / 1.31 | 0x00000000 | Sub Cross Over BQ coefficient |
| 0x6C | 0x12 | CH-Sub BQ 3 B0 | 4 / 1.31 | 0x7FFFFFFF | Sub Cross Over BQ coefficient |
| 0x70 | 0x12 | CH-Sub BQ 3 B1 | 4 / 2.30 | 0x00000000 | Sub Cross Over BQ coefficient |
| 0x74 | 0x12 | CH-Sub BQ 3 B2 | 4 / 1.31 | 0x00000000 | Sub Cross Over BQ coefficient |
| 0x78 | 0x12 | CH-Sub BQ 3 A1 | 4 / 2.30 | 0x00000000 | Sub Cross Over BQ coefficient |
| 0x7C | 0x12 | CH-Sub BQ 3 A2 | 4 / 1.31 | 0x00000000 | Sub Cross Over BQ coefficient |
| 0x08 | 0x13 | CH-Sub BQ 4 B0 | 4 / 1.31 | 0x7FFFFFFF | Sub Cross Over BQ coefficient |
| 0x0C | 0x13 | CH-Sub BQ 4 B1 | 4 / 2.30 | 0x00000000 | Sub Cross Over BQ coefficient |
| 0x10 | 0x13 | CH-Sub BQ 4 B2 | 4 / 1.31 | 0x00000000 | Sub Cross Over BQ coefficient |
| 0x14 | 0x13 | CH-Sub BQ 4 A1 | 4 / 2.30 | 0x00000000 | Sub Cross Over BQ coefficient |
| 0x18 | 0x13 | CH-Sub BQ 4 A2 | 4 / 1.31 | 0x00000000 | Sub Cross Over BQ coefficient |
| 0x1C | 0x13 | CH-Sub BQ 5 B0 | 4 / 1.31 | 0x7FFFFFFF | Sub Cross Over BQ coefficient |

Table 12. DSP Memory Map for Process Flow 6 — Book 0x8C (continued)

| Sub Address | Page | Register Name | Number of Bytes/Format | Default Value | Description |
|--------------------------------|------|----------------|------------------------|---------------|-------------------------------|
| 0x20 | 0x13 | CH-Sub BQ 5 B1 | 4 / 2.30 | 0x00000000 | Sub Cross Over BQ coefficient |
| 0x24 | 0x13 | CH-Sub BQ 5 B2 | 4 / 1.31 | 0x00000000 | Sub Cross Over BQ coefficient |
| 0x28 | 0x13 | CH-Sub BQ 5 A1 | 4 / 2.30 | 0x00000000 | Sub Cross Over BQ coefficient |
| 0x2C | 0x13 | CH-Sub BQ 5 A2 | 4 / 1.31 | 0x00000000 | Sub Cross Over BQ coefficient |
| DPEQ SENSE BQ | | | | | |
| 0x58 | 0x14 | BQ 1 B0 | 4 / 1.31 | 0x7FFFFFFF | DPEQ sense BQ coefficient |
| 0x5C | 0x14 | BQ 1 B1 | 4 / 2.30 | 0x00000000 | DPEQ sense BQ coefficient |
| 0x60 | 0x14 | BQ 1 B2 | 4 / 1.31 | 0x00000000 | DPEQ sense BQ coefficient |
| 0x64 | 0x14 | BQ 1 A1 | 4 / 2.30 | 0x00000000 | DPEQ sense BQ coefficient |
| 0x68 | 0x14 | BQ 1 A2 | 4 / 1.31 | 0x00000000 | DPEQ sense BQ coefficient |
| 0x6C | 0x14 | BQ 2 B0 | 4 / 1.31 | 0x7FFFFFFF | DPEQ sense BQ coefficient |
| 0x70 | 0x14 | BQ 2 B1 | 4 / 2.30 | 0x00000000 | DPEQ sense BQ coefficient |
| 0x74 | 0x14 | BQ 2 B2 | 4 / 1.31 | 0x00000000 | DPEQ sense BQ coefficient |
| 0x78 | 0x14 | BQ 2 A1 | 4 / 2.30 | 0x00000000 | DPEQ sense BQ coefficient |
| 0x7C | 0x14 | BQ 2 A2 | 4 / 1.31 | 0x00000000 | DPEQ sense BQ coefficient |
| DPEQ LOW LEVEL PATH BQ | | | | | |
| 0x08 | 0x15 | BQ 1 B0 | 4 / 1.31 | 0x7FFFFFFF | DPEQ low BQ coefficient |
| 0x0C | 0x15 | BQ 1 B1 | 4 / 2.30 | 0x00000000 | DPEQ low BQ coefficient |
| 0x10 | 0x15 | BQ 1 B2 | 4 / 1.31 | 0x00000000 | DPEQ low BQ coefficient |
| 0x14 | 0x15 | BQ 1 A1 | 4 / 2.30 | 0x00000000 | DPEQ low BQ coefficient |
| 0x18 | 0x15 | BQ 1 A2 | 4 / 1.31 | 0x00000000 | DPEQ low BQ coefficient |
| 0x1C | 0x15 | BQ 2 B0 | 4 / 1.31 | 0x7FFFFFFF | DPEQ low BQ coefficient |
| 0x20 | 0x15 | BQ 2 B1 | 4 / 2.30 | 0x00000000 | DPEQ low BQ coefficient |
| 0x24 | 0x15 | BQ 2 B2 | 4 / 1.31 | 0x00000000 | DPEQ low BQ coefficient |
| 0x28 | 0x15 | BQ 2 A1 | 4 / 2.30 | 0x00000000 | DPEQ low BQ coefficient |
| 0x2C | 0x15 | BQ 2 A2 | 4 / 1.31 | 0x00000000 | DPEQ low BQ coefficient |
| DPEQ HIGH LEVEL PATH BQ | | | | | |
| 0x30 | 0x15 | BQ 1 B0 | 4 / 1.31 | 0x7FFFFFFF | DPEQ high BQ coefficient |
| 0x34 | 0x15 | BQ 1 B1 | 4 / 2.30 | 0x00000000 | DPEQ high BQ coefficient |
| 0x38 | 0x15 | BQ 1 B2 | 4 / 1.31 | 0x00000000 | DPEQ high BQ coefficient |
| 0x3C | 0x15 | BQ 1 A1 | 4 / 2.30 | 0x00000000 | DPEQ high BQ coefficient |
| 0x40 | 0x15 | BQ 1 A2 | 4 / 1.31 | 0x00000000 | DPEQ high BQ coefficient |
| 0x44 | 0x15 | BQ 2 B0 | 4 / 1.31 | 0x7FFFFFFF | DPEQ high BQ coefficient |
| 0x48 | 0x15 | BQ 2 B1 | 4 / 2.30 | 0x00000000 | DPEQ high BQ coefficient |
| 0x4C | 0x15 | BQ 2 B2 | 4 / 1.31 | 0x00000000 | DPEQ high BQ coefficient |
| 0x50 | 0x15 | BQ 2 A1 | 4 / 2.30 | 0x00000000 | DPEQ high BQ coefficient |
| 0x54 | 0x15 | BQ 2 A2 | 4 / 1.31 | 0x00000000 | DPEQ high BQ coefficient |
| EQ LEFT 14 BQs | | | | | |
| 0x58 | 0x15 | CH -L BQ 1 B0 | 4 / 1.31 | 0x7FFFFFFF | Left BQ coefficient |
| 0x5C | 0x15 | CH -L BQ 1 B1 | 4 / 2.30 | 0x00000000 | Left BQ coefficient |
| 0x60 | 0x15 | CH -L BQ 1 B2 | 4 / 1.31 | 0x00000000 | Left BQ coefficient |
| 0x64 | 0x15 | CH -L BQ 1 A1 | 4 / 2.30 | 0x00000000 | Left BQ coefficient |
| 0x68 | 0x15 | CH -L BQ 1 A2 | 4 / 1.31 | 0x00000000 | Left BQ coefficient |
| 0x6C | 0x15 | CH -L BQ 2 B0 | 4 / 1.31 | 0x7FFFFFFF | Left BQ coefficient |
| 0x70 | 0x15 | CH -L BQ 2 B1 | 4 / 2.30 | 0x00000000 | Left BQ coefficient |
| 0x74 | 0x15 | CH -L BQ 2 B2 | 4 / 1.31 | 0x00000000 | Left BQ coefficient |
| 0x78 | 0x15 | CH -L BQ 2 A1 | 4 / 2.30 | 0x00000000 | Left BQ coefficient |
| 0x7C | 0x15 | CH -L BQ 2 A2 | 4 / 1.31 | 0x00000000 | Left BQ coefficient |
| 0x08 | 0x16 | CH -L BQ 3 B0 | 4 / 1.31 | 0x7FFFFFFF | Left BQ coefficient |
| 0x0C | 0x16 | CH -L BQ 3 B1 | 4 / 2.30 | 0x00000000 | Left BQ coefficient |
| 0x10 | 0x16 | CH -L BQ 3 B2 | 4 / 1.31 | 0x00000000 | Left BQ coefficient |

Table 12. DSP Memory Map for Process Flow 6 — Book 0x8C (continued)

| Sub Address | Page | Register Name | Number of Bytes/Format | Default Value | Description |
|-------------|------|----------------|------------------------|---------------|---------------------|
| 0x14 | 0x16 | CH -L BQ 3 A1 | 4 / 2.30 | 0x00000000 | Left BQ coefficient |
| 0x18 | 0x16 | CH -L BQ 3 A2 | 4 / 1.31 | 0x00000000 | Left BQ coefficient |
| 0x1C | 0x16 | CH -L BQ 4 B0 | 4 / 1.31 | 0x7FFFFFFF | Left BQ coefficient |
| 0x20 | 0x16 | CH -L BQ 4 B1 | 4 / 2.30 | 0x00000000 | Left BQ coefficient |
| 0x24 | 0x16 | CH -L BQ 4 B2 | 4 / 1.31 | 0x00000000 | Left BQ coefficient |
| 0x28 | 0x16 | CH -L BQ 4 A1 | 4 / 2.30 | 0x00000000 | Left BQ coefficient |
| 0x2C | 0x16 | CH -L BQ 4 A2 | 4 / 1.31 | 0x00000000 | Left BQ coefficient |
| 0x30 | 0x16 | CH -L BQ 5 B0 | 4 / 1.31 | 0x7FFFFFFF | Left BQ coefficient |
| 0x34 | 0x16 | CH -L BQ 5 B1 | 4 / 2.30 | 0x00000000 | Left BQ coefficient |
| 0x38 | 0x16 | CH -L BQ 5 B2 | 4 / 1.31 | 0x00000000 | Left BQ coefficient |
| 0x3C | 0x16 | CH -L BQ 5 A1 | 4 / 2.30 | 0x00000000 | Left BQ coefficient |
| 0x40 | 0x16 | CH -L BQ 5 A2 | 4 / 1.31 | 0x00000000 | Left BQ coefficient |
| 0x44 | 0x16 | CH -L BQ 6 B0 | 4 / 1.31 | 0x7FFFFFFF | Left BQ coefficient |
| 0x48 | 0x16 | CH -L BQ 6 B1 | 4 / 2.30 | 0x00000000 | Left BQ coefficient |
| 0x4C | 0x16 | CH -L BQ 6 B2 | 4 / 1.31 | 0x00000000 | Left BQ coefficient |
| 0x50 | 0x16 | CH -L BQ 6 A1 | 4 / 2.30 | 0x00000000 | Left BQ coefficient |
| 0x54 | 0x16 | CH -LBQ 6 A2 | 4 / 1.31 | 0x00000000 | Left BQ coefficient |
| 0x58 | 0x16 | CH -L BQ 7 B0 | 4 / 1.31 | 0x7FFFFFFF | Left BQ coefficient |
| 0x5C | 0x16 | CH -L BQ 7 B1 | 4 / 2.30 | 0x00000000 | Left BQ coefficient |
| 0x60 | 0x16 | CH -L BQ 7 B2 | 4 / 1.31 | 0x00000000 | Left BQ coefficient |
| 0x64 | 0x16 | CH -L BQ 7 A1 | 4 / 2.30 | 0x00000000 | Left BQ coefficient |
| 0x68 | 0x16 | CH -L BQ 7 A2 | 4 / 1.31 | 0x00000000 | Left BQ coefficient |
| 0x6C | 0x16 | CH -L BQ 8 B0 | 4 / 1.31 | 0x7FFFFFFF | Left BQ coefficient |
| 0x70 | 0x16 | CH -L BQ 8 B1 | 4 / 2.30 | 0x00000000 | Left BQ coefficient |
| 0x74 | 0x16 | CH -L BQ 8 B2 | 4 / 1.31 | 0x00000000 | Left BQ coefficient |
| 0x78 | 0x16 | CH -L BQ 8 A1 | 4 / 2.30 | 0x00000000 | Left BQ coefficient |
| 0x7C | 0x16 | CH -L BQ 8 A2 | 4 / 1.31 | 0x00000000 | Left BQ coefficient |
| 0x08 | 0x17 | CH -L BQ 9 B0 | 4 / 1.31 | 0x7FFFFFFF | Left BQ coefficient |
| 0x0C | 0x17 | CH -L BQ 9 B1 | 4 / 2.30 | 0x00000000 | Left BQ coefficient |
| 0x10 | 0x17 | CH -L BQ 9 B2 | 4 / 1.31 | 0x00000000 | Left BQ coefficient |
| 0x14 | 0x17 | CH -L BQ 9 A1 | 4 / 2.30 | 0x00000000 | Left BQ coefficient |
| 0x18 | 0x17 | CH -L BQ 9 A2 | 4 / 1.31 | 0x00000000 | Left BQ coefficient |
| 0x1C | 0x17 | CH -L BQ 10 B0 | 4 / 1.31 | 0x7FFFFFFF | Left BQ coefficient |
| 0x20 | 0x17 | CH -L BQ 10 B1 | 4 / 2.30 | 0x00000000 | Left BQ coefficient |
| 0x24 | 0x17 | CH -L BQ 10 B2 | 4 / 1.31 | 0x00000000 | Left BQ coefficient |
| 0x28 | 0x17 | CH -L BQ 10 A1 | 4 / 2.30 | 0x00000000 | Left BQ coefficient |
| 0x2C | 0x17 | CH -L BQ 10 A2 | 4 / 1.31 | 0x00000000 | Left BQ coefficient |
| 0x30 | 0x17 | CH -L BQ 11 B0 | 4 / 1.31 | 0x7FFFFFFF | Left BQ coefficient |
| 0x34 | 0x17 | CH -L BQ 11 B1 | 4 / 2.30 | 0x00000000 | Left BQ coefficient |
| 0x38 | 0x17 | CH -L BQ 11 B2 | 4 / 1.31 | 0x00000000 | Left BQ coefficient |
| 0x3C | 0x17 | CH -L BQ 11 A1 | 4 / 2.30 | 0x00000000 | Left BQ coefficient |
| 0x40 | 0x17 | CH -L BQ 11 A2 | 4 / 1.31 | 0x00000000 | Left BQ coefficient |
| 0x44 | 0x17 | CH -L BQ 12 B0 | 4 / 1.31 | 0x7FFFFFFF | Left BQ coefficient |
| 0x48 | 0x17 | CH -L BQ 12 B1 | 4 / 2.30 | 0x00000000 | Left BQ coefficient |
| 0x4C | 0x17 | CH -L BQ 12 B2 | 4 / 1.31 | 0x00000000 | Left BQ coefficient |
| 0x50 | 0x17 | CH -L BQ 12 A1 | 4 / 2.30 | 0x00000000 | Left BQ coefficient |
| 0x54 | 0x17 | CH -L BQ 12 A2 | 4 / 1.31 | 0x00000000 | Left BQ coefficient |
| 0x58 | 0x17 | CH -L BQ 13 B0 | 4 / 1.31 | 0x7FFFFFFF | Left BQ coefficient |
| 0x5C | 0x17 | CH -L BQ 13 B1 | 4 / 2.30 | 0x00000000 | Left BQ coefficient |
| 0x60 | 0x17 | CH -L BQ 13 B2 | 4 / 1.31 | 0x00000000 | Left BQ coefficient |
| 0x64 | 0x17 | CH -L BQ 13 A1 | 4 / 2.30 | 0x00000000 | Left BQ coefficient |

Table 12. DSP Memory Map for Process Flow 6 — Book 0x8C (continued)

| Sub Address | Page | Register Name | Number of Bytes/Format | Default Value | Description |
|------------------------|------|----------------|------------------------|---------------|--------------------------------|
| 0x68 | 0x17 | CH -L BQ 13 A2 | 4 / 1.31 | 0x00000000 | Left BQ coefficient |
| 0x6C | 0x17 | CH -L BQ 14 B0 | 4 / 1.31 | 0x7FFFFFFF | Left BQ coefficient |
| 0x70 | 0x17 | CH -L BQ 14 B1 | 4 / 2.30 | 0x00000000 | Left BQ coefficient |
| 0x74 | 0x17 | CH -L BQ 14 B2 | 4 / 1.31 | 0x00000000 | Left BQ coefficient |
| 0x78 | 0x17 | CH -L BQ 14 A1 | 4 / 2.30 | 0x00000000 | Left BQ coefficient |
| 0x7C | 0x17 | CH -L BQ 14 A2 | 4 / 1.31 | 0x00000000 | Left BQ coefficient |
| LEFT INTGAIN BQ | | | | | |
| 0x08 | 0x18 | CH -L BQ 15 B0 | 4 / 5.27 | 0x08000000 | Left gain scale BQ coefficient |
| 0x0C | 0x18 | CH -L BQ 15 B1 | 4 / 6.26 | 0x00000000 | Left gain scale BQ coefficient |
| 0x10 | 0x18 | CH -L BQ 15 B2 | 4 / 5.27 | 0x00000000 | Left gain scale BQ coefficient |
| 0x14 | 0x18 | CH -L BQ 15 A1 | 4 / 2.30 | 0x00000000 | Left gain scale BQ coefficient |
| 0x18 | 0x18 | CH -L BQ 15 A2 | 4 / 1.31 | 0x00000000 | Left gain scale BQ coefficient |
| EQ RIGHT 14 BQs | | | | | |
| 0x1C | 0x18 | CH -R BQ 1 B0 | 4 / 1.31 | 0x7FFFFFFF | Right BQ coefficient |
| 0x20 | 0x18 | CH -R BQ 1 B1 | 4 / 2.30 | 0x00000000 | Right BQ coefficient |
| 0x24 | 0x18 | CH -R BQ 1 B2 | 4 / 1.31 | 0x00000000 | Right BQ coefficient |
| 0x28 | 0x18 | CH -R BQ 1 A1 | 4 / 2.30 | 0x00000000 | Right BQ coefficient |
| 0x2C | 0x18 | CH -R BQ 1 A2 | 4 / 1.31 | 0x00000000 | Right BQ coefficient |
| 0x30 | 0x18 | CH -R BQ 2 B0 | 4 / 1.31 | 0x7FFFFFFF | Right BQ coefficient |
| 0x34 | 0x18 | CH -R BQ 2 B1 | 4 / 2.30 | 0x00000000 | Right BQ coefficient |
| 0x38 | 0x18 | CH -R BQ 2 B2 | 4 / 1.31 | 0x00000000 | Right BQ coefficient |
| 0x3C | 0x18 | CH -R BQ 2 A1 | 4 / 2.30 | 0x00000000 | Right BQ coefficient |
| 0x40 | 0x18 | CH -R BQ 2 A2 | 4 / 1.31 | 0x00000000 | Right BQ coefficient |
| 0x44 | 0x18 | CH -R BQ 3 B0 | 4 / 1.31 | 0x7FFFFFFF | Right BQ coefficient |
| 0x48 | 0x18 | CH -R BQ 3 B1 | 4 / 2.30 | 0x00000000 | Right BQ coefficient |
| 0x4C | 0x18 | CH -R BQ 3 B2 | 4 / 1.31 | 0x00000000 | Right BQ coefficient |
| 0x50 | 0x18 | CH -R BQ 3 A1 | 4 / 2.30 | 0x00000000 | Right BQ coefficient |
| 0x54 | 0x18 | CH -R BQ 3 A2 | 4 / 1.31 | 0x00000000 | Right BQ coefficient |
| 0x58 | 0x18 | CH -R BQ 4 B0 | 4 / 1.31 | 0x7FFFFFFF | Right BQ coefficient |
| 0x5C | 0x18 | CH -R BQ 4 B1 | 4 / 2.30 | 0x00000000 | Right BQ coefficient |
| 0x60 | 0x18 | CH -R BQ 4 B2 | 4 / 1.31 | 0x00000000 | Right BQ coefficient |
| 0x64 | 0x18 | CH -R BQ 4 A1 | 4 / 2.30 | 0x00000000 | Right BQ coefficient |
| 0x68 | 0x18 | CH -R BQ 4 A2 | 4 / 1.31 | 0x00000000 | Right BQ coefficient |
| 0x6C | 0x18 | CH -R BQ 5 B0 | 4 / 1.31 | 0x7FFFFFFF | Right BQ coefficient |
| 0x70 | 0x18 | CH -R BQ 5 B1 | 4 / 2.30 | 0x00000000 | Right BQ coefficient |
| 0x74 | 0x18 | CH -R BQ 5 B2 | 4 / 1.31 | 0x00000000 | Right BQ coefficient |
| 0x78 | 0x18 | CH -R BQ 5 A1 | 4 / 2.30 | 0x00000000 | Right BQ coefficient |
| 0x7C | 0x18 | CH -R BQ 5 A2 | 4 / 1.31 | 0x00000000 | Right BQ coefficient |
| 0x08 | 0x19 | CH -R BQ 6 B0 | 4 / 1.31 | 0x7FFFFFFF | Right BQ coefficient |
| 0x0C | 0x19 | CH -R BQ 6 B1 | 4 / 2.30 | 0x00000000 | Right BQ coefficient |
| 0x10 | 0x19 | CH -R BQ 6 B2 | 4 / 1.31 | 0x00000000 | Right BQ coefficient |
| 0x14 | 0x19 | CH -R BQ 6 A1 | 4 / 2.30 | 0x00000000 | Right BQ coefficient |
| 0x18 | 0x19 | CH -R BQ 6 A2 | 4 / 1.31 | 0x00000000 | Right BQ coefficient |
| 0x1C | 0x19 | CH -R BQ 7 B0 | 4 / 1.31 | 0x7FFFFFFF | Right BQ coefficient |
| 0x20 | 0x19 | CH -R BQ 7 B1 | 4 / 2.30 | 0x00000000 | Right BQ coefficient |
| 0x24 | 0x19 | CH -R BQ 7 B2 | 4 / 1.31 | 0x00000000 | Right BQ coefficient |
| 0x28 | 0x19 | CH -R BQ 7 A1 | 4 / 2.30 | 0x00000000 | Right BQ coefficient |
| 0x2C | 0x19 | CH -R BQ 7 A2 | 4 / 1.31 | 0x00000000 | Right BQ coefficient |
| 0x30 | 0x19 | CH -R BQ 8 B0 | 4 / 1.31 | 0x7FFFFFFF | Right BQ coefficient |
| 0x34 | 0x19 | CH -R BQ 8 B1 | 4 / 2.30 | 0x00000000 | Right BQ coefficient |
| 0x38 | 0x19 | CH -R BQ 8 B2 | 4 / 1.31 | 0x00000000 | Right BQ coefficient |

Table 12. DSP Memory Map for Process Flow 6 — Book 0x8C (continued)

| Sub Address | Page | Register Name | Number of Bytes/Format | Default Value | Description |
|----------------------------|------|------------------------|------------------------|---------------|---------------------------------|
| 0x3C | 0x19 | CH -R BQ 8 A1 | 4 / 2.30 | 0x00000000 | Right BQ coefficient |
| 0x40 | 0x19 | CH -R BQ 8 A2 | 4 / 1.31 | 0x00000000 | Right BQ coefficient |
| 0x44 | 0x19 | CH -R BQ 9 B0 | 4 / 1.31 | 0x7FFFFFFF | Right BQ coefficient |
| 0x48 | 0x19 | CH -R BQ 9 B1 | 4 / 2.30 | 0x00000000 | Right BQ coefficient |
| 0x4C | 0x19 | CH -R BQ 9 B2 | 4 / 1.31 | 0x00000000 | Right BQ coefficient |
| 0x50 | 0x19 | CH -R BQ 9 A1 | 4 / 2.30 | 0x00000000 | Right BQ coefficient |
| 0x54 | 0x19 | CH -R BQ 9 A2 | 4 / 1.31 | 0x00000000 | Right BQ coefficient |
| 0x58 | 0x19 | CH -R BQ 10 B0 | 4 / 1.31 | 0x7FFFFFFF | Right BQ coefficient |
| 0x5C | 0x19 | CH -R BQ 10 B1 | 4 / 2.30 | 0x00000000 | Right BQ coefficient |
| 0x60 | 0x19 | CH -R BQ 10 B2 | 4 / 1.31 | 0x00000000 | Right BQ coefficient |
| 0x64 | 0x19 | CH -R BQ 10 A1 | 4 / 2.30 | 0x00000000 | Right BQ coefficient |
| 0x68 | 0x19 | CH -R BQ 10 A2 | 4 / 1.31 | 0x00000000 | Right BQ coefficient |
| 0x6C | 0x19 | CH -R BQ 11 B0 | 4 / 1.31 | 0x7FFFFFFF | Right BQ coefficient |
| 0x70 | 0x19 | CH -R BQ 11 B1 | 4 / 2.30 | 0x00000000 | Right BQ coefficient |
| 0x74 | 0x19 | CH -R BQ 11 B2 | 4 / 1.31 | 0x00000000 | Right BQ coefficient |
| 0x78 | 0x19 | CH -R BQ 11 A1 | 4 / 2.30 | 0x00000000 | Right BQ coefficient |
| 0x7C | 0x19 | CH -R BQ 11 A2 | 4 / 1.31 | 0x00000000 | Right BQ coefficient |
| 0x08 | 0x1A | CH -R BQ 12 B0 | 4 / 1.31 | 0x7FFFFFFF | Right BQ coefficient |
| 0x0C | 0x1A | CH -R BQ 12 B1 | 4 / 2.30 | 0x00000000 | Right BQ coefficient |
| 0x10 | 0x1A | CH -R BQ 12 B2 | 4 / 1.31 | 0x00000000 | Right BQ coefficient |
| 0x14 | 0x1A | CH -R BQ 12 A1 | 4 / 2.30 | 0x00000000 | Right BQ coefficient |
| 0x18 | 0x1A | CH -R BQ 12 A2 | 4 / 1.31 | 0x00000000 | Right BQ coefficient |
| 0x1C | 0x1A | CH -R BQ 13 B0 | 4 / 1.31 | 0x7FFFFFFF | Right BQ coefficient |
| 0x20 | 0x1A | CH -R BQ 13 B1 | 4 / 2.30 | 0x00000000 | Right BQ coefficient |
| 0x24 | 0x1A | CH -R BQ 13 B2 | 4 / 1.31 | 0x00000000 | Right BQ coefficient |
| 0x28 | 0x1A | CH -R BQ 13 A1 | 4 / 2.30 | 0x00000000 | Right BQ coefficient |
| 0x2C | 0x1A | CH -R BQ 13 A2 | 4 / 1.31 | 0x00000000 | Right BQ coefficient |
| 0x30 | 0x1A | CH -R BQ 14 B0 | 4 / 1.31 | 0x7FFFFFFF | Right BQ coefficient |
| 0x34 | 0x1A | CH -R BQ 14 B1 | 4 / 2.30 | 0x00000000 | Right BQ coefficient |
| 0x38 | 0x1A | CH -R BQ 14 B2 | 4 / 1.31 | 0x00000000 | Right BQ coefficient |
| 0x3C | 0x1A | CH -R BQ 14 A1 | 4 / 2.30 | 0x00000000 | Right BQ coefficient |
| 0x40 | 0x1A | CH -R BQ 14 A2 | 4 / 1.31 | 0x00000000 | Right BQ coefficient |
| RIGHT INTGAIN BQ | | | | | |
| 0x44 | 0x1A | CH -R BQ 15 B0 | 4 / 5.27 | 0x08000000 | Right gain scale BQ coefficient |
| 0x48 | 0x1A | CH -R BQ 15 B1 | 4 / 6.26 | 0x00000000 | Right gain scale BQ coefficient |
| 0x4C | 0x1A | CH -R BQ 15 B2 | 4 / 5.27 | 0x00000000 | Right gain scale BQ coefficient |
| 0x50 | 0x1A | CH -R BQ 15 A1 | 4 / 2.30 | 0x00000000 | Right gain scale BQ coefficient |
| 0x54 | 0x1A | CH -R BQ 15 A2 | 4 / 1.31 | 0x00000000 | Right gain scale BQ coefficient |
| VOLUME ALPHA FILTER | | | | | |
| 0x58 | 0x1A | Softening Filter Alpha | 4 / 1.31 | 0x00A7264A | Volume time constant |
| PHASE OPTIMIZER | | | | | |
| 0x60 | 0x1A | Delay Left | 4 / 32.0 | 0x00000000 | Left Channel Phase Optimizer |
| 0x64 | 0x1A | Delay Right | 4 / 32.0 | 0x00000000 | Right Channel Phase Optimizer |
| 0x68 | 0x1A | Delay Sub | 4 / 32.0 | 0x00000000 | Sub Channel Phase Optimizer |
| SPATIALIZER BQs | | | | | |
| 0x6C | 0x1C | BQ 1 B0 | 4 / 1.31 | 0x7FFFFFFF | Spatializer BQ coefficient |
| 0x70 | 0x1C | BQ 1 B1 | 4 / 2.30 | 0x00000000 | Spatializer BQ coefficient |
| 0x74 | 0x1C | BQ 1 B2 | 4 / 1.31 | 0x00000000 | Spatializer BQ coefficient |
| 0x78 | 0x1C | BQ 1 A1 | 4 / 2.30 | 0x00000000 | Spatializer BQ coefficient |
| 0x7C | 0x1C | BQ 1 A2 | 4 / 1.31 | 0x00000000 | Spatializer BQ coefficient |
| 0x08 | 0x1D | BQ 2 B0 | 4 / 1.31 | 0x7FFFFFFF | Spatializer BQ coefficient |

Table 12. DSP Memory Map for Process Flow 6 — Book 0x8C (continued)

| Sub Address | Page | Register Name | Number of Bytes/Format | Default Value | Description |
|----------------------------|------|--------------------------|------------------------|---------------|---------------------------------------|
| 0x0C | 0x1D | BQ 2 B1 | 4 / 2.30 | 0x00000000 | Spatializer BQ coefficient |
| 0x10 | 0x1D | BQ 2 B2 | 4 / 1.31 | 0x00000000 | Spatializer BQ coefficient |
| 0x14 | 0x1D | BQ 2 A1 | 4 / 2.30 | 0x00000000 | Spatializer BQ coefficient |
| 0x18 | 0x1D | BQ 2 A2 | 4 / 1.31 | 0x00000000 | Spatializer BQ coefficient |
| DPEQ CONTROL | | | | | |
| 0x1C | 0x1D | Alpha | 4 / 1.31 | 0x02DEAD00 | DPEQ Sense Energy Time constant |
| 0x20 | 0x1D | Gain | 4 / 1.31 | 0x74013901 | DPEQ Threshold Gain |
| 0x24 | 0x1D | Offset | 4 / 1.31 | 0x0020C49B | DPEQ Threshold Offset |
| SUB CHANNEL CONTROL | | | | | |
| 0x28 | 0x1D | No Sub | 4 / 32.0 | 0x00000000 | Sub Channel Flag |
| THD CLIPPER | | | | | |
| 0x2C | 0x1D | CH-LR THD Boost | 4 / 9.23 | 0x00800000 | THD LR Channel prescale coefficient |
| 0x30 | 0x1D | CH-Sub THD Boost | 4 / 9.23 | 0x00800000 | THD Sub Channel prescale coefficient |
| 0x34 | 0x1D | CH-L Fine Volume | 4 / 2.30 | 0x3FFFFFFF | THD L Channel postscale coefficient |
| 0x38 | 0x1D | CH-R Fine Volume | 4 / 2.30 | 0x3FFFFFFF | THD R Channel postscale coefficient |
| 0x3C | 0x1D | CH-Sub Fine Volume | 4 / 2.30 | 0x3FFFFFFF | THD Sub Channel postscale coefficient |
| GANG EQ | | | | | |
| 0x58 | 0x1D | Gang LR EQ | 4 / 32.0 | 0x00000000 | Gang Left and Right EQ flag |
| INPUT MIXER | | | | | |
| 0x5C | 0x1D | Left to Left | 4 / 9.23 | 0x00800000 | Left Channel Mixer Left Input Gain |
| 0x60 | 0x1D | Right to Left | 4 / 9.23 | 0x00000000 | Left Channel Mixer Right Input Gain |
| 0x64 | 0x1D | Left to Right | 4 / 9.23 | 0x00000000 | Right Channel Mixer Left Input Gain |
| 0x68 | 0x1D | Right to Right | 4 / 9.23 | 0x00800000 | Right Channel Mixer Right Input Gain |
| MIX/GAIN ADJUST | | | | | |
| 0x6C | 0x1D | Left to Sub | 4 / 9.23 | 0x00000000 | Sub Channel Mixer Left Input Gain |
| 0x70 | 0x1D | Right to Sub | 4 / 9.23 | 0x00000000 | Sub Channel Mixer Right Input Gain |
| 0x74 | 0x1D | Sub Mix ScratchL | 4 / 9.23 | 0x00800000 | Sub Channel Mixer ScratchL Input Gain |
| 0x78 | 0x1D | Sub Mix ScratchR | 4 / 9.23 | 0x00000000 | Sub Channel Mixer ScratchR Input Gain |
| 0x7C | 0x1D | Bass Mono Left | 4 / 9.23 | 0x00800000 | Mono Left Input Gain |
| 0x08 | 0x1E | Bass Mono Right | 4 / 9.23 | 0x00800000 | Mono Right Input Gain |
| 0x0C | 0x1E | Bass Mono Sub | 4 / 9.23 | 0x00000000 | Mono Sub Input Gain |
| SPATIALIZER LEVEL | | | | | |
| 0x10 | 0x1E | Spatializer Level | 4 / 9.23 | 0x00000000 | Spatializer Level coefficient |
| OUTPUT CROSS BAR | | | | | |
| 0x14 | 0x1E | Digital Left from Left | 4 / 9.23 | 0x00800000 | I2S Left output gain from left |
| 0x18 | 0x1E | Digital Left from Right | 4 / 9.23 | 0x00000000 | I2S Left output gain from Right |
| 0x1C | 0x1E | Digital Left from Sub | 4 / 9.23 | 0x00000000 | I2S Left output gain from Sub |
| 0x20 | 0x1E | Digital Right from Left | 4 / 9.23 | 0x00000000 | I2S Right output gain from left |
| 0x24 | 0x1E | Digital Right from Right | 4 / 9.23 | 0x00800000 | I2S Right output gain from Right |
| 0x28 | 0x1E | Digital Right from Sub | 4 / 9.23 | 0x00000000 | I2S Right output gain from Sub |
| 0x2C | 0x1E | Analog Left from Left | 4 / 9.23 | 0x00800000 | Analog Left output gain from left |
| 0x30 | 0x1E | Analog Left from Right | 4 / 9.23 | 0x00000000 | Analog Left output gain from Right |
| 0x34 | 0x1E | Analog Left from Sub | 4 / 9.23 | 0x00000000 | Analog Left output gain from Sub |
| 0x38 | 0x1E | Analog Right from Left | 4 / 9.23 | 0x00000000 | Analog Right output gain from left |
| 0x3C | 0x1E | Analog Right from Right | 4 / 9.23 | 0x00800000 | Analog Right output gain from Right |
| 0x40 | 0x1E | Analog Right from Sub | 4 / 9.23 | 0x00000000 | Analog Right output gain from Sub |
| VOLUME CONTROL | | | | | |
| 0x44 | 0x1E | CH-L Volume | 4 / 9.23 | 0x00800000 | Left Channel volume coefficient |
| 0x48 | 0x1E | CH-R Volume | 4 / 9.23 | 0x00800000 | Right Channel volume coefficient |
| 0x4C | 0x1E | CH-Sub Volume | 4 / 9.23 | 0x00800000 | Sub Channel volume coefficient |

Table 12. DSP Memory Map for Process Flow 6 — Book 0x8C (continued)

| Sub Address | Page | Register Name | Number of Bytes/Format | Default Value | Description |
|-------------------------|------|------------------|------------------------|---------------|------------------------------------|
| DPEQ GAIN SCALE | | | | | |
| 0x50 | 0x1E | DPEQ Sense Scale | 4 / 2.30 | 0x40000000 | DPEQ Sense Input Gain |
| 0x54 | 0x1E | DPEQ Low Scale | 4 / 6.26 | 0x04000000 | DPEQ Low Input Gain |
| 0x58 | 0x1E | DPEQ High Scale | 4 / 6.26 | 0x04000000 | DPEQ High Input Gain |
| THERMAL PROTECT | | | | | |
| 0x5C | 0x1E | Thermal | 4 / - | 0x0020C49C | Generated by GUI |
| 0x60 | 0x1E | Thermal | 4 / - | 0x0020C49C | Generated by GUI |
| 0x64 | 0x1E | Thermal | 4 / - | 0x0020C49C | Generated by GUI |
| 0x68 | 0x1E | Thermal | 4 / - | 0x0020C49C | Generated by GUI |
| RAM | | | | | |
| THERMAL PROTECT | | | | | |
| 0x34 | 0x1F | Thermal | 4 / - | 0x00A7264A | Generated by GUI |
| 0x38 | 0x1F | Thermal | 4 / - | 0x00A7264A | Generated by GUI |
| MORPHING CONTROL | | | | | |
| 0x3C | 0x1F | Morphing Energy | 4 / 1.31 | 0x7FFFFFFF | Morphing Energy Time constant |
| 0x40 | 0x1F | Morphing Attack | 4 / 1.31 | 0x7FFFFFFF | Morphing Attack Time constant |
| 0x44 | 0x1F | Morphing Decay | 4 / 1.31 | 0x7FFFFFFF | Morphing Decay Time constant |
| 0x48 | 0x1F | Morphing K0_1 | 4 / 9.23 | 0x00000000 | Morphing Region 1 Slope (comp/Exp) |
| 0x4C | 0x1F | Morphing K1_1 | 4 / 9.23 | 0x00000000 | Morphing Region 2 Slope (comp/Exp) |
| 0x50 | 0x1F | Morphing K2_1 | 4 / 9.23 | 0x00000000 | Morphing Region 3 Slope (comp/Exp) |
| 0x54 | 0x1F | Morphing T1_1 | 4 / 9.23 | 0xE7000000 | Morphing Threshold 1 |
| 0x58 | 0x1F | Morphing T2_1 | 4 / 9.23 | 0xFE800000 | Morphing Threshold 2 |
| 0x5C | 0x1F | Morphing off1_1 | 4 / 9.23 | 0x00000000 | Morphing Offset 1 |
| 0x60 | 0x1F | Morphing off2_1 | 4 / 9.23 | 0x00000000 | Morphing Offset 2 |
| EXCURSION | | | | | |
| 0x64 | 0x1F | Excursion | 4 / - | 0x024D9999 | Generated by GUI |
| 0x68 | 0x1F | Excursion | 4 / - | 0xFDB26667 | Generated by GUI |
| 0x6C | 0x1F | Excursion | 4 / - | 0x00800000 | Generated by GUI |
| 0x70 | 0x1F | Excursion | 4 / - | 0x00000000 | Generated by GUI |
| 0x74 | 0x1F | Excursion | 4 / - | 0x00000000 | Generated by GUI |
| 0x78 | 0x1F | Excursion | 4 / - | 0x00000000 | Generated by GUI |
| 0x7C | 0x1F | Excursion | 4 / - | 0x00000000 | Generated by GUI |
| 0x08 | 0x20 | Excursion | 4 / - | 0x00000000 | Generated by GUI |
| 0x0C | 0x20 | Excursion | 4 / - | 0x00000000 | Generated by GUI |
| 0x10 | 0x20 | Excursion | 4 / - | 0x00000000 | Generated by GUI |
| 0x14 | 0x20 | Excursion | 4 / - | 0x00000000 | Generated by GUI |
| 0x18 | 0x20 | Excursion | 4 / - | 0x00000000 | Generated by GUI |
| 0x1C | 0x20 | Excursion | 4 / - | 0x00000000 | Generated by GUI |
| 0x20 | 0x20 | Excursion | 4 / - | 0x00000000 | Generated by GUI |
| 0x24 | 0x20 | Excursion | 4 / - | 0x00000000 | Generated by GUI |
| 0x28 | 0x20 | Excursion | 4 / - | 0x00000000 | Generated by GUI |
| 0x2C | 0x20 | Excursion | 4 / - | 0x00000000 | Generated by GUI |
| 0x30 | 0x20 | Excursion | 4 / - | 0x00000000 | Generated by GUI |
| 0x34 | 0x20 | Excursion | 4 / - | 0x00000000 | Generated by GUI |
| 0x38 | 0x20 | Excursion | 4 / - | 0x00000000 | Generated by GUI |
| 0x3C | 0x20 | Excursion | 4 / - | 0x00000000 | Generated by GUI |
| 0x40 | 0x20 | Excursion | 4 / - | 0x00000000 | Generated by GUI |
| 0x44 | 0x20 | Excursion | 4 / - | 0x00000000 | Generated by GUI |
| 0x48 | 0x20 | Excursion | 4 / - | 0x00000000 | Generated by GUI |
| 0x4C | 0x20 | Excursion | 4 / - | 0x00000000 | Generated by GUI |
| 0x50 | 0x20 | Excursion | 4 / - | 0x00000000 | Generated by GUI |

Table 12. DSP Memory Map for Process Flow 6 — Book 0x8C (continued)

| Sub Address | Page | Register Name | Number of Bytes/Format | Default Value | Description |
|---------------------------------|------|-------------------|------------------------|---------------|---------------------------|
| 0x54 | 0x20 | Excursion | 4 / - | 0x00000000 | Generated by GUI |
| 0x58 | 0x20 | Excursion | 4 / - | 0x00000000 | Generated by GUI |
| 0x5C | 0x20 | Excursion | 4 / - | 0x00000000 | Generated by GUI |
| 0x60 | 0x20 | Excursion | 4 / - | 0x00000000 | Generated by GUI |
| 0x64 | 0x20 | Excursion | 4 / - | 0x00000000 | Generated by GUI |
| 0x68 | 0x20 | Excursion | 4 / - | 0x00000000 | Generated by GUI |
| 0x6C | 0x20 | Excursion | 4 / - | 0x00000000 | Generated by GUI |
| 0x70 | 0x20 | Excursion | 4 / - | 0x7FFFFFFF | Generated by GUI |
| 0x74 | 0x20 | Excursion | 4 / - | 0x00000000 | Generated by GUI |
| 0x78 | 0x20 | Excursion | 4 / - | 0x00000000 | Generated by GUI |
| 0x7C | 0x20 | Excursion | 4 / - | 0x00000000 | Generated by GUI |
| 0x08 | 0x21 | Excursion | 4 / - | 0x00000000 | Generated by GUI |
| 0x0C | 0x21 | Excursion | 4 / - | 0x7FFFFFFF | Generated by GUI |
| 0x10 | 0x21 | Excursion | 4 / - | 0x00000000 | Generated by GUI |
| 0x14 | 0x21 | Excursion | 4 / - | 0x00000000 | Generated by GUI |
| 0x18 | 0x21 | Excursion | 4 / - | 0x00000000 | Generated by GUI |
| 0x1C | 0x21 | Excursion | 4 / - | 0x00000000 | Generated by GUI |
| MORPHING BQs | | | | | |
| 0x20 | 0x21 | BQ 1 B0 | 4 / 1.31 | 0x7FFFFFFF | Morphing BQ coefficient |
| 0x24 | 0x21 | BQ 1 B1 | 4 / 2.30 | 0x00000000 | Morphing BQ coefficient |
| 0x28 | 0x21 | BQ 1 B2 | 4 / 1.31 | 0x00000000 | Morphing BQ coefficient |
| 0x2C | 0x21 | BQ 1 A1 | 4 / 2.30 | 0x00000000 | Morphing BQ coefficient |
| 0x30 | 0x21 | BQ 1 A2 | 4 / 1.31 | 0x00000000 | Morphing BQ coefficient |
| 0x34 | 0x21 | BQ 2 B0 | 4 / 1.31 | 0x7FFFFFFF | Morphing BQ coefficient |
| 0x38 | 0x21 | BQ 2 B1 | 4 / 2.30 | 0x00000000 | Morphing BQ coefficient |
| 0x3C | 0x21 | BQ 2 B2 | 4 / 1.31 | 0x00000000 | Morphing BQ coefficient |
| 0x40 | 0x21 | BQ 2 A1 | 4 / 2.30 | 0x00000000 | Morphing BQ coefficient |
| 0x44 | 0x21 | BQ 2 A2 | 4 / 1.31 | 0x00000000 | Morphing BQ coefficient |
| 0x48 | 0x21 | CH-Sub Gain scale | 4 / 9.23 | 0x00800000 | Sub Channel Morphing Gain |
| THERMAL PROTECT TRESHOLD | | | | | |
| 0x4C | 0x21 | Thermal | 4 / - | 0x7FFFFFFF | Generated by GUI |
| 0x50 | 0x21 | Thermal | 4 / - | 0x7FFFFFFF | Generated by GUI |

Power-Up and Power-Down Sequence

B.1 Power-Up Sequence

Use the following list for power-up:

1. Hold all digital inputs low and bring up power supplies (it doesn't matter if AVDD/DVDD or PVDD comes up first).
2. Hold $\overline{\text{RESET}}$ low and initialize digital inputs to their desired states. Wait at least 100 μs , pull $\overline{\text{RESET}}$ high and then wait at least another 100 μs .
3. Configure the SAI (Serial Audio Interface) as required via i2c and then start MCLK, SCLK and LRCLK (no sequence required).
4. Mute the device (write 0x11 to B0-P0-R3) or pulling low $\overline{\text{SPK_MUTE}}$ pin.
5. Once clocks are stable, put the device into normal operation mode (write 0x00 to B0-P0-R2), and wait at least 103 FS periods (normally 5ms).
6. Start to program DSP coefficients. If a process flow with SmartAmp processing is used, like Process Flow 2, Process Flow 4 or Process Flow 6, it is required to download DSP instructions only after DSP has been reset (write 0x80 to B0-P0-R2).
7. Unmute the device (write 0x00 to B0-P0-R3) or pulling high $\overline{\text{SPK_MUTE}}$ pin.
8. The device is now in normal operation.

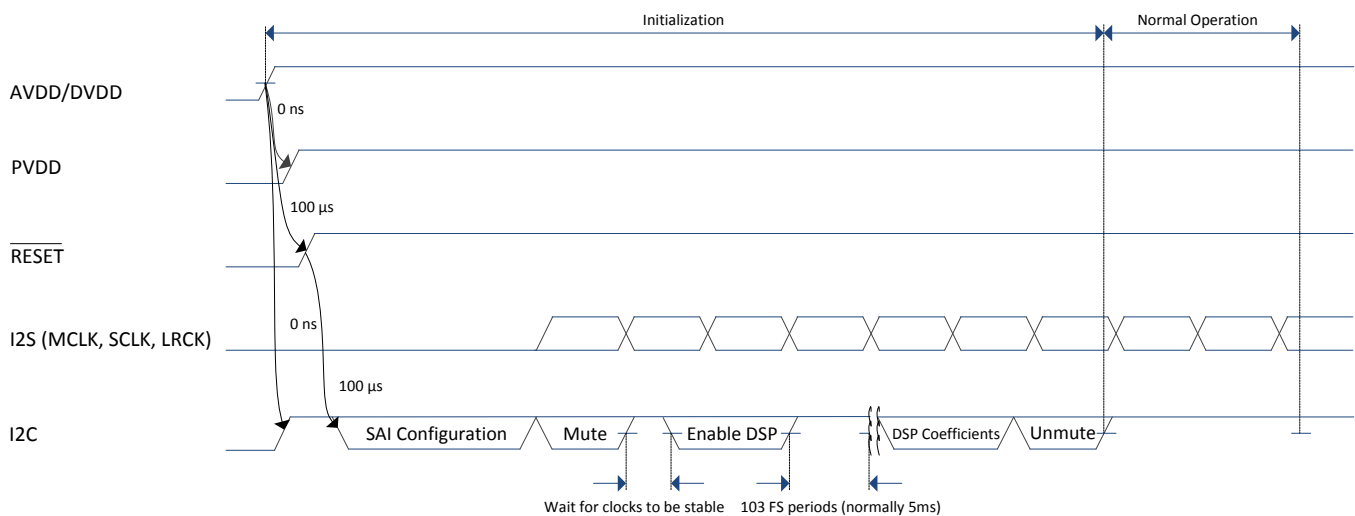

Figure 36. Power-Up Timing

B.2 Power-Down Sequence

The following list details the power-down sequence:

1. Put the device into power down mode (write 0x01 to B0-P0-R2).
2. Wait at least 2 ms and then pull $\overline{\text{RESET}}$ low.
3. The clocks can be stopped and the power supplies brought down after $\overline{\text{RESET}}$ has been low for at least 2 μs .
4. The device is now fully shutdown and powered off.

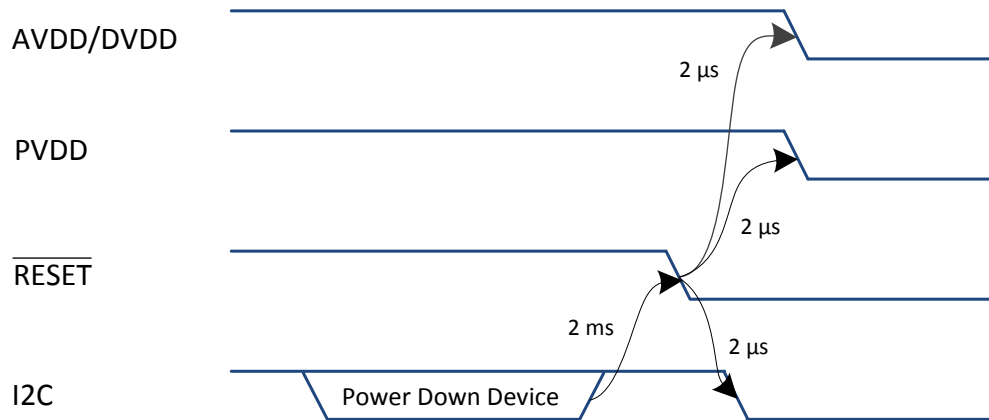

Figure 37. Power-Down Timing

Revision History

NOTE: Page numbers for previous revisions may differ from page numbers in the current version.

| Changes from A Revision (June 2017) to B Revision | Page |
|--|------|
| Added use cases to Supported Use Cases . | 4 |
| Added Process Flows 5–6 . | 5 |
| Added Process Flow 5 (48 kHz, 2.1 Standard Processing) . | 14 |
| Added Process Flow 6 (48 kHz, 2.1 SmartAmp Processing) . | 16 |
| Added DSP Memory Map for Process Flow 5 . | 70 |
| Added DSP Memory Map for Process Flow 6 . | 79 |

Revision History

| Changes from Original (March 2017) to A Revision | Page |
|--|------|
| Deleted the following sentence, "All BQ coefficients are written in the 1.31 format." in the <i>Equalizer</i> section. | 19 |
| Deleted sentence and equation below the <i>Volume Attack and Decay</i> image. | 21 |
| Deleted <i>SWAP FLAG</i> entry from <i>DSP Memory Map for Process Flow 1 — Book 0x8C</i> table. | 46 |
| Deleted <i>SWAP FLAG</i> entry from <i>DSP Memory Map for Process Flow 2 — Book 0x8C</i> table. | 51 |
| Changed title of the table in the <i>DSP Memory Map for Process Flow 3</i> section to the current title. | 56 |
| Deleted <i>SWAP FLAG</i> entry from <i>DSP Memory Map for Process Flow 3 — Book 0x8C</i> table. | 56 |
| Changed title of the table in the <i>DSP Memory Map for Process Flow 4</i> section to the current title. | 63 |
| Deleted <i>SWAP FLAG</i> entry from <i>DSP Memory Map for Process Flow 4 — Book 0x8C</i> table. | 63 |

IMPORTANT NOTICE FOR TI DESIGN INFORMATION AND RESOURCES

Texas Instruments Incorporated ("TI") technical, application or other design advice, services or information, including, but not limited to, reference designs and materials relating to evaluation modules, (collectively, "TI Resources") are intended to assist designers who are developing applications that incorporate TI products; by downloading, accessing or using any particular TI Resource in any way, you (individually or, if you are acting on behalf of a company, your company) agree to use it solely for this purpose and subject to the terms of this Notice.

TI's provision of TI Resources does not expand or otherwise alter TI's applicable published warranties or warranty disclaimers for TI products, and no additional obligations or liabilities arise from TI providing such TI Resources. TI reserves the right to make corrections, enhancements, improvements and other changes to its TI Resources.

You understand and agree that you remain responsible for using your independent analysis, evaluation and judgment in designing your applications and that you have full and exclusive responsibility to assure the safety of your applications and compliance of your applications (and of all TI products used in or for your applications) with all applicable regulations, laws and other applicable requirements. You represent that, with respect to your applications, you have all the necessary expertise to create and implement safeguards that (1) anticipate dangerous consequences of failures, (2) monitor failures and their consequences, and (3) lessen the likelihood of failures that might cause harm and take appropriate actions. You agree that prior to using or distributing any applications that include TI products, you will thoroughly test such applications and the functionality of such TI products as used in such applications. TI has not conducted any testing other than that specifically described in the published documentation for a particular TI Resource.

You are authorized to use, copy and modify any individual TI Resource only in connection with the development of applications that include the TI product(s) identified in such TI Resource. NO OTHER LICENSE, EXPRESS OR IMPLIED, BY ESTOPPEL OR OTHERWISE TO ANY OTHER TI INTELLECTUAL PROPERTY RIGHT, AND NO LICENSE TO ANY TECHNOLOGY OR INTELLECTUAL PROPERTY RIGHT OF TI OR ANY THIRD PARTY IS GRANTED HEREIN, including but not limited to any patent right, copyright, mask work right, or other intellectual property right relating to any combination, machine, or process in which TI products or services are used. Information regarding or referencing third-party products or services does not constitute a license to use such products or services, or a warranty or endorsement thereof. Use of TI Resources may require a license from a third party under the patents or other intellectual property of the third party, or a license from TI under the patents or other intellectual property of TI.

TI RESOURCES ARE PROVIDED "AS IS" AND WITH ALL FAULTS. TI DISCLAIMS ALL OTHER WARRANTIES OR REPRESENTATIONS, EXPRESS OR IMPLIED, REGARDING TI RESOURCES OR USE THEREOF, INCLUDING BUT NOT LIMITED TO ACCURACY OR COMPLETENESS, TITLE, ANY EPIDEMIC FAILURE WARRANTY AND ANY IMPLIED WARRANTIES OF MERCHANTABILITY, FITNESS FOR A PARTICULAR PURPOSE, AND NON-INFRINGEMENT OF ANY THIRD PARTY INTELLECTUAL PROPERTY RIGHTS.

TI SHALL NOT BE LIABLE FOR AND SHALL NOT DEFEND OR INDEMNIFY YOU AGAINST ANY CLAIM, INCLUDING BUT NOT LIMITED TO ANY INFRINGEMENT CLAIM THAT RELATES TO OR IS BASED ON ANY COMBINATION OF PRODUCTS EVEN IF DESCRIBED IN TI RESOURCES OR OTHERWISE. IN NO EVENT SHALL TI BE LIABLE FOR ANY ACTUAL, DIRECT, SPECIAL, COLLATERAL, INDIRECT, PUNITIVE, INCIDENTAL, CONSEQUENTIAL OR EXEMPLARY DAMAGES IN CONNECTION WITH OR ARISING OUT OF TI RESOURCES OR USE THEREOF, AND REGARDLESS OF WHETHER TI HAS BEEN ADVISED OF THE POSSIBILITY OF SUCH DAMAGES.

You agree to fully indemnify TI and its representatives against any damages, costs, losses, and/or liabilities arising out of your non-compliance with the terms and provisions of this Notice.

This Notice applies to TI Resources. Additional terms apply to the use and purchase of certain types of materials, TI products and services. These include; without limitation, TI's standard terms for semiconductor products (<http://www.ti.com/sc/docs/stdterms.htm>), [evaluation modules](#), and [samples](http://www.ti.com/sc/docs/sampterm.htm) (<http://www.ti.com/sc/docs/sampterm.htm>).

Mailing Address: Texas Instruments, Post Office Box 655303, Dallas, Texas 75265
Copyright © 2017, Texas Instruments Incorporated