

## I<sup>2</sup>C CONTROLLED 18 CHANNEL GPIO EXPANDER

 Check for Samples: [TCA6418E](#)

### FEATURES

- **Operating Power-Supply Voltage Range of 1.65 V to 3.6 V**
- **18 GPIOs Configurable as Inputs or Outputs**
- **ESD Protection Exceeds JESD 22 on Non-GPIO Pins**
  - **2000-V Human Body Model (A114-A)**
  - **1000-V Charged Device Model (C101)**
- **Low Standby (Idle) Current Consumption: 3  $\mu$ A**
- **Supports 1-MHz Fast Mode Plus I<sup>2</sup>C Bus**
- **Open-Drain Active-Low Interrupt Output, Asserted When Key is Pressed or Key is Released**
- **Selectable Debounce Time of 50  $\mu$ s**
- **Schmitt-Trigger Action Allows Slow Input Transition and Better Switching Noise Immunity at the SCL and SDA Inputs: Typical  $V_{hys}$  at 1.8 V is 0.18 V**
- **Latch-Up Performance Exceeds 200 mA Per JESD 78, Class II**
- **Very Small Package**
  - **WCSP (YFP): 2 mm  $\times$  2 mm; 0.4 mm pitch**

### APPLICATIONS

- **Smart Phones**
- **PDA's**
- **GPS Devices**
- **MP3 Players**
- **Digital Cameras**

### DESCRIPTION/ORDERING INFORMATION

The TCA6418E is a 18 channel GPIO expansion device with integrated ESD protection. It can operate from 1.65 V to 3.6 V and has 18 general purpose inputs/outputs (GPIO) that can be used via the I<sup>2</sup>C interface [serial clock (SCL), serial data (SDA)].

The major benefit of this device is it frees up the processor from having to individually monitor changes in multiple inputs and also frees up the GPIOs on the processor to drive other outputs.. This provides power and bandwidth savings. The TCA6418E is also ideal for usage with processors that have limited GPIOs.

#### ORDERING INFORMATION<sup>(1)</sup>

T <sub>A</sub>	PACKAGE <sup>(2)</sup>		ORDERABLE PART NUMBER	TOP-SIDE MARKING
–40°C to 85°C	WCSP – YFP	Tape and reel	TCA6418EYFPR	AZ2

(1) For the most current package and ordering information, see the Package Option Addendum at the end of this document, or see the TI web site at [www.ti.com](http://www.ti.com).

(2) Package drawings, thermal data, and symbolization are available at [www.ti.com/packaging](http://www.ti.com/packaging).



Please be aware that an important notice concerning availability, standard warranty, and use in critical applications of Texas Instruments semiconductor products and disclaimers thereto appears at the end of this data sheet.



This integrated circuit can be damaged by ESD. Texas Instruments recommends that all integrated circuits be handled with appropriate precautions. Failure to observe proper handling and installation procedures can cause damage.

ESD damage can range from subtle performance degradation to complete device failure. Precision integrated circuits may be more susceptible to damage because very small parametric changes could cause the device not to meet its published specifications.

#### YFP PACKAGE

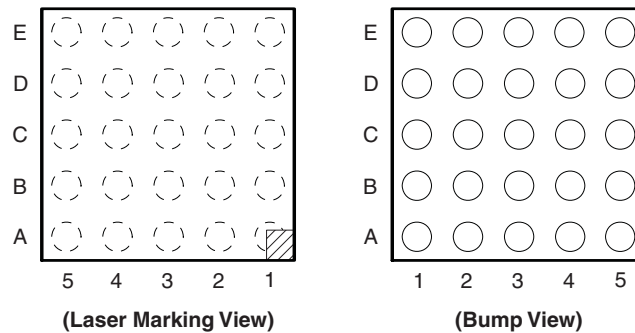

**Table 1. YFP Package Terminal Assignments**

<b>E</b>	$\overline{\text{INT}}$	GND	GPIO13	GPIO8	GPIO4
<b>D</b>	SCL	GPIO17	GPIO12	GPIO7	GPIO3
<b>C</b>	SDA	GPIO16	GPIO11	GPIO6	GPIO2
<b>B</b>	$V_{\text{CC}}$	GPIO15	GPIO10	GND	GPIO1
<b>A</b>	$\overline{\text{RESET}}$	GPIO14	GPIO9	GPIO5	GPIO0
	<b>5</b>	<b>4</b>	<b>3</b>	<b>2</b>	<b>1</b>

**TERMINAL FUNCTIONS**

TERMINAL		TYPE	DESCRIPTION
NO.	NAME		
WCSP (YFP)			
A1	GPIO0	I/O	GPIO port
B1	GPIO1	I/O	GPIO port
C1	GPIO2	I/O	GPIO port
D1	GPIO3	I/O	GPIO port
E1	GPIO4	I/O	GPIO port
A2	GPIO5	I/O	GPIO port
B2	GND	-	Ground
C2	GPIO6	I/O	GPIO port
D2	GPIO7	I/O	GPIO port
E2	GPIO8	I/O	GPIO port
A3	GPIO9	I/O	GPIO port
B3	GPIO10	I/O	GPIO port
C3	GPIO11	I/O	GPIO port
D3	GPIO12	I/O	GPIO port
E3	GPIO13	I/O	GPIO port
A4	GPIO14	I/O	GPIO port
B4	GPIO15	I/O	GPIO port
C4	GPIO16	I/O	GPIO port
D4	GPIO17	I/O	GPIO port
E4	GND	-	Ground
A5	$\overline{\text{RESET}}$	I	Active-low reset input. Connect to $V_{CC}$ through a pullup resistor, if no active connection is used.
B5	$V_{CC}$	Pwr	Supply voltage of 1.65 V to 3.6 V
C5	SDA	I/O	Serial data bus. Connect to $V_{CC}$ through a pullup resistor.
D5	SCL	I	Serial clock bus. Connect to $V_{CC}$ through a pullup resistor.
E5	$\overline{\text{INT}}$	O	Active-low interrupt output. Open drain structure. Connect to $V_{CC}$ through a pullup resistor.

## ABSOLUTE MAXIMUM RATINGS<sup>(1)</sup>

over operating free-air temperature range (unless otherwise noted)

			MIN	MAX	UNIT
V <sub>CC</sub>	Supply voltage range		-0.5	4.6	V
V <sub>I</sub>	Input voltage range <sup>(2)</sup>		-0.5	4.6	V
V <sub>O</sub>	Voltage range applied to any output in the high-impedance or power-off state <sup>(2)</sup>		-0.5	4.6	V
	Output voltage range in the high or low state <sup>(2)</sup>		-0.5	4.6	
I <sub>IK</sub>	Input clamp current	V <sub>I</sub> < 0		±20	mA
I <sub>OK</sub>	Output clamp current	V <sub>O</sub> < 0		±20	mA
I <sub>OL</sub>	Continuous output Low current	P port, SDA	V <sub>O</sub> = 0 to V <sub>CC</sub>	50	mA
		INT		25	
I <sub>OH</sub>	Continuous output High current	P port	V <sub>O</sub> = 0 to V <sub>CC</sub>	50	
T <sub>stg</sub>	Storage temperature range		-65	150	°C

- (1) Stresses beyond those listed under [ABSOLUTE MAXIMUM RATINGS](#) may cause permanent damage to the device. These are stress ratings only, and functional operation of the device at these or any other conditions beyond those indicated under [RECOMMENDED OPERATING CONDITIONS](#) is not implied. Exposure to absolute-maximum-rated conditions for extended periods may affect device reliability.
- (2) The input negative-voltage and output voltage ratings may be exceeded if the input and output current ratings are observed.

## THERMAL CHARACTERISTICS

over operating free-air temperature range (unless otherwise noted)

			VALUE	UNIT
θ <sub>JA</sub>	Package thermal impedance <sup>(1)</sup>	YFP package	98.8	°C/W

- (1) The package thermal impedance is calculated in accordance with JESD 51-7.

## RECOMMENDED OPERATING CONDITIONS

			MIN	MAX	UNIT
V <sub>CC</sub>	Supply voltage		1.65	3.6	V
V <sub>IH</sub>	High-level input voltage	SCL, SDA, GPIO0-17, RESET	0.7 × V <sub>CC</sub>	3.6	V
V <sub>IL</sub>	Low-level input voltage	SCL, SDA, GPIO0-17, RESET	-0.5	0.3 × V <sub>CC</sub>	V
I <sub>OH</sub>	High-level output current	GPIO0-17		10	mA
I <sub>OL</sub>	Low-level output current	GPIO0-17		25	mA
T <sub>A</sub>	Operating free-air temperature		-40	85	°C

## ELECTRICAL CHARACTERISTICS

 over recommended operating free-air temperature range,  $V_{CC} = 1.65\text{ V to }3.6\text{ V}$  (unless otherwise noted)

PARAMETER		TEST CONDITIONS	$V_{CCP}$	MIN	TYP	MAX	UNIT	
$V_{IK}$	Input diode clamp voltage	$I_I = -18\text{ mA}$	1.65 V to 3.6 V	-1.2			V	
$V_{POR}$	Power-on reset voltage	$V_I = V_{CCP}$ or GND, $I_O = 0$	1.65 V to 3.6 V		1	1.4	V	
$V_{OH}$	GPIO0-17 high-level output voltage	$I_{OH} = -1\text{ mA}$	1.65 V	1.25			V	
		$I_{OH} = -8\text{ mA}$	1.65 V	1.2				
			2.3 V	1.8				
		$I_{OH} = -10\text{ mA}$	3 V	2.6				
			1.65 V	1.1				
			2.3 V	1.7				
$V_{OL}$	GPIO0-17 low-level output voltage	$I_{OL} = 1\text{ mA}$	1.65 V			0.4	V	
			1.65 V			0.45		
		$I_{OL} = 8\text{ mA}$	2.3 V			0.25		
			3 V			0.25		
		$I_{OL} = 10\text{ mA}$	1.65 V			0.6		
			2.3 V			0.3		
3 V				0.25				
$I_{OL}$	SDA	$V_{OL} = 0.4\text{ V}$	1.65 V to 3.6 V	3			mA	
	$\overline{\text{INT}}$	$V_{OL} = 0.4\text{ V}$	1.65 V to 3.6 V	3				
$I_I$	SCL, SDA, GPIO0-17, $\overline{\text{RESET}}$	$V_I = V_{CC1}$ or GND; Pull-downs disabled for GPIO0-17	1.65 V to 3.6 V			1	$\mu\text{A}$	
$r_{INT}$	GPIO0-17				55		k $\Omega$	
$I_{CC}$		$V_I$ on SDA, GPIO0-17, = $V_{CC}$ or GND, $I_O = 0$ , I/O = inputs,	1.65 V to 3.6 V	$f_{SCL} = 0\text{ kHz}$		13	$\mu\text{A}$	
				$f_{SCL} = 400\text{ kHz}$		25		
				$f_{SCL} = 1\text{ MHz}$		35		
$C_1$	SCL	$V_I = V_{CC1}$ or GND	1.65 V to 3.6 V		6	8	pF	
$C_{io}$	SDA	$V_{IO} = V_{CC}$ or GND	1.65 V to 3.6 V		10	12.5	pF	
	GPIO0-17				5	6		

## I<sup>2</sup>C INTERFACE TIMING REQUIREMENTS

over recommended operating free-air temperature range (unless otherwise noted) (see [Figure 12](#))

	STANDARD MODE I <sup>2</sup> C BUS		FAST MODE I <sup>2</sup> C BUS		FAST MODE PLUS (FM+) I <sup>2</sup> C BUS		UNIT
	MIN	MAX	MIN	MAX	MIN	MAX	
$f_{scl}$ I <sup>2</sup> C clock frequency	0	100	0	400	0	1000	kHz
$t_{sch}$ I <sup>2</sup> C clock high time	4		0.6		0.26		μs
$t_{scl}$ I <sup>2</sup> C clock low time	4.7		1.3		0.5		μs
$t_{sp}$ I <sup>2</sup> C spike time		50		50		50	ns
$t_{sds}$ I <sup>2</sup> C serial data setup time	250		100		50		ns
$t_{sdh}$ I <sup>2</sup> C serial data hold time	0		0		0		ns
$t_{icr}$ I <sup>2</sup> C input rise time		1000	$20 + 0.1C_b^{(1)}$	300		120	ns
$t_{icf}$ I <sup>2</sup> C input fall time		300	$20 + 0.1C_b^{(1)}$	300		120	ns
$t_{ocf}$ I <sup>2</sup> C output fall time; 10 pF to 400 pF bus		300	$20 + 0.1C_b^{(1)}$	300		120	μs
$t_{buf}$ I <sup>2</sup> C bus free time between Stop and Start	4.7		1.3		0.5		μs
$t_{sts}$ I <sup>2</sup> C Start or repeater Start condition setup time	4.7		0.6		0.26		μs
$t_{sth}$ I <sup>2</sup> C Start or repeater Start condition hold time	4		0.6		0.26		μs
$t_{sps}$ I <sup>2</sup> C Stop condition setup time	4		0.6		0.26		μs
$t_{vd(data)}$ Valid data time; SCL low to SDA output valid		1		0.9		0.45	μs
$t_{vd(ack)}$ Valid data time of ACK condition; ACK signal from SCL low to SDA (out) low		1		0.9		0.45	μs

(1)  $C_b$  = total capacitance of one bus line in pF

## RESET TIMING REQUIREMENTS

over recommended operating free-air temperature range (unless otherwise noted) (see [Figure 15](#))

	STANDARD MODE, FAST MODE, FAST MODE PLUS (FM+) I <sup>2</sup> C BUS		UNIT
	MIN	MAX	
$t_W$ Reset pulse duration	120 <sup>(1)</sup>		μs
$t_{REC}$ Reset recovery time	120 <sup>(1)</sup>		μs
$t_{RESET}$ Time to reset	120 <sup>(1)</sup>		μs

(1) The GPIO debounce circuit uses each GPIO input which passes through a two-stage register circuit. Both registers are clocked by the same clock signal, presumably free-running, with a nominal period of 50μs. When an input changes state, the new state is clocked into the first stage on one clock transition. On the next same-direction transition, if the input state is still the same as the previously clocked state, the signal is clocked into the second stage, and then on to the remaining circuits. Since the inputs are asynchronous to the clock, it will take anywhere from zero to 50 μsec after the input transition to clock the signal into the first stage. Therefore, the total debounce time may be as long as 100 μsec. Finally, to account for a slow clock, the spec further guard-banded at 120 μsec.

**SWITCHING CHARACTERISTICS**

PARAMETER		FROM	TO	STANDARD MODE, FAST MODE, FAST MODE PLUS (FM+) I <sup>2</sup> C BUS		UNIT
				MIN	MAX	
t <sub>IV</sub>	Interrupt valid time	GPIO0-17	$\overline{\text{INT}}$	40	120	μs
				0	1	
t <sub>IR</sub>	Interrupt reset delay time	SCL	$\overline{\text{INT}}$		1	μs
t <sub>PV</sub>	Output data valid	SCL	GPIO0-17		400	ns
t <sub>PS</sub>	Input data setup time	GPIO	SCL	0		ns
t <sub>PH</sub>	Input data hold time					
		GPIO	SCL	300		ns

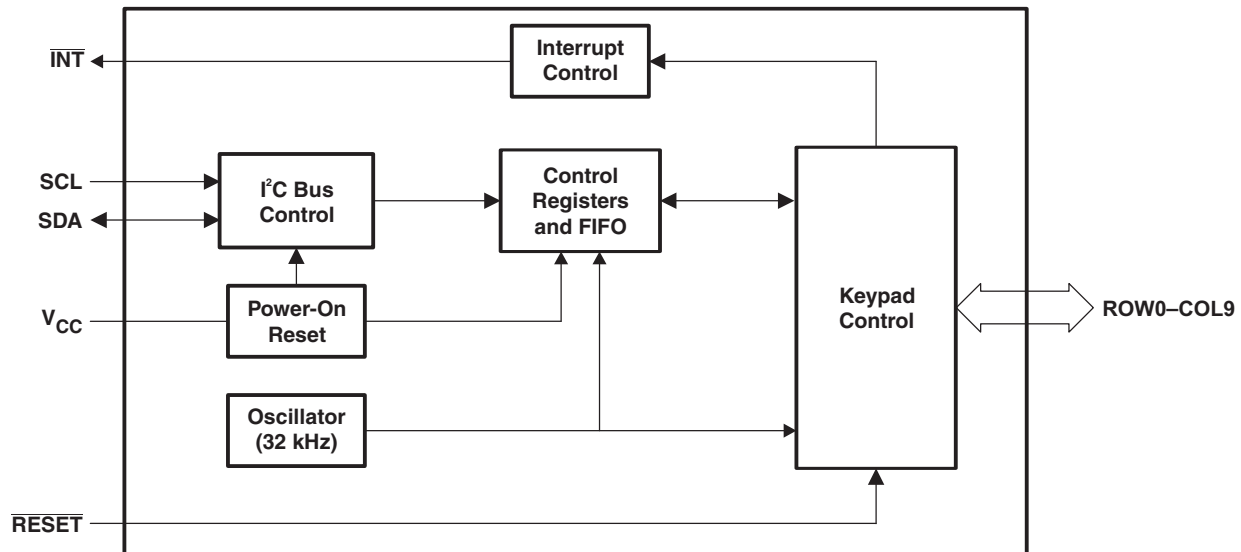
**LOGIC DIAGRAM (POSITIVE LOGIC)**

At power on, the GPIOs are configured as inputs with internal 50-kΩ pulldown resistors enabled; however, the system master can enable the GPIOs to function as inputs or outputs.

The system master can reset the TCA6418E in the event of a timeout or other improper operation by asserting a low in the  $\overline{\text{RESET}}$  input, while keeping the  $V_{CC}$  at its operating level.

A reset can be accomplished by holding the  $\overline{\text{RESET}}$  pin low for a minimum of  $t_{W}$ . The TCA6418E registers and I<sup>2</sup>C/SMBus state machine are changed to their default state once  $\overline{\text{RESET}}$  is low (0). When  $\overline{\text{RESET}}$  is high (1), the I/O levels at the P port can be changed externally or through the master. This input requires a pullup resistor to  $V_{CC}$ , if no active connection is used.

The power-on reset puts the registers in their default state and initializes the I<sup>2</sup>C/SMBus state machine. The  $\overline{\text{RESET}}$  pin causes the same reset/initialization to occur without de-powering the part.

The open-drain interrupt ( $\overline{\text{INT}}$ ) output is used to indicate to the system master that an input state has changed.  $\overline{\text{INT}}$  can be connected to the interrupt input of a microcontroller. By sending an interrupt signal on this line, the remote input can inform the microcontroller if there is incoming data on its ports without having to communicate via the I<sup>2</sup>C bus. Thus, the TCA6418E can remain a simple slave device.

## Power-On Reset

When power (from 0 V) is applied to  $V_{CC}$ , an internal power-on reset holds the TCA6418E in a reset condition until  $V_{CC}$  reaches  $V_{POR}$ . At that time, the reset condition is released, and the TCA6418E registers and I<sup>2</sup>C/SMBus state machine initialize to their default states. After that,  $V_{CC}$  must be lowered below 0.2 V and back up to the operating voltage for a power-reset cycle.

## Power-On Reset Requirements

In the event of a glitch or data corruption, TCA6418E can be reset to its default conditions by using the power-on reset feature. Power-on reset requires that the device go through a power cycle to be completely reset. This reset also happens when the device is powered on for the first time in an application.

The two types of power-on reset are shown in [Figure 1](#) and [Figure 2](#).

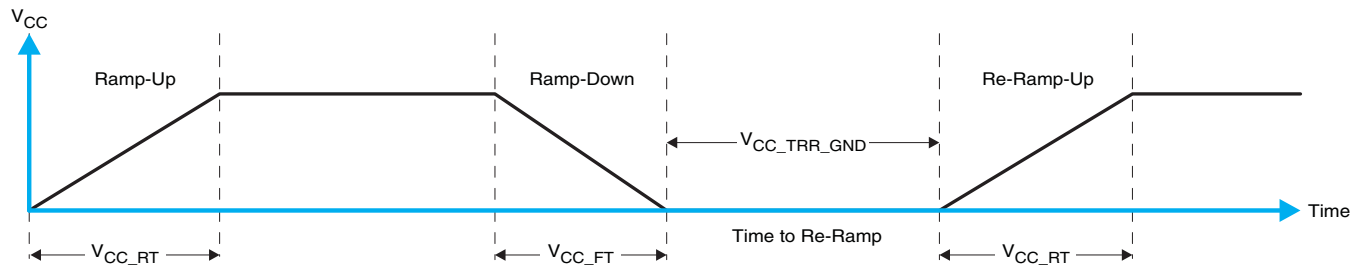

**Figure 1.  $V_{CC}$  is Lowered Below 0.2 V or 0 V and Then Ramped Up to  $V_{CC}$**

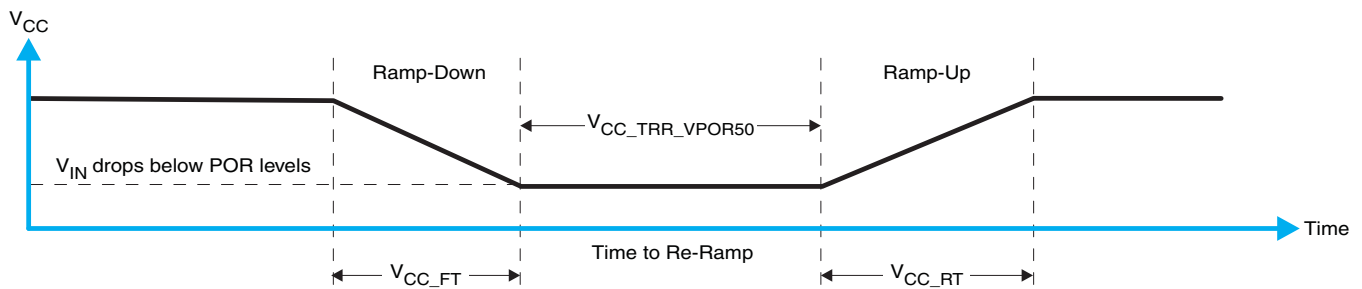

**Figure 2.  $V_{CC}$  is Lowered Below the POR Threshold, Then Ramped Back Up to  $V_{CC}$**

[Table 2](#) specifies the performance of the power-on reset feature for TCA6418E for both types of power-on reset.

**Table 2. RECOMMENDED SUPPLY SEQUENCING AND RAMP RATES<sup>(1)</sup>**

PARAMETER			MIN	TYP	MAX	UNIT
$V_{CC\_FT}$	Fall rate	See <a href="#">Figure 1</a>	1	100		ms
$V_{CC\_RT}$	Rise rate	See <a href="#">Figure 1</a>	0.01	100		ms
$V_{CC\_TRR\_GND}$	Time to re-ramp (when $V_{CC}$ drops to GND)	See <a href="#">Figure 1</a>	0.001			ms
$V_{CC\_TRR\_POR50}$	Time to re-ramp (when $V_{CC}$ drops to $V_{POR\_MIN} - 50$ mV)	See <a href="#">Figure 2</a>	0.001			ms
$V_{CC\_GH}$	Level that $V_{CCP}$ can glitch down to, but not cause a functional disruption when $V_{CCX\_GW} = 1$ $\mu$ s	See <a href="#">Figure 3</a>			1.2	V
$V_{CC\_GW}$	Glitch width that will not cause a functional disruption when $V_{CCX\_GH} = 0.5 \times V_{CCx}$	See <a href="#">Figure 3</a>				$\mu$ s
$V_{PORF}$	Voltage trip point of POR on falling $V_{CC}$		0.767		1.144	V
$V_{PORR}$	Voltage trip point of POR on rising $V_{CC}$		1.033		1.428	V

(1)  $T_A = -40^\circ\text{C}$  to  $85^\circ\text{C}$  (unless otherwise noted)



Glitches in the power supply can also affect the power-on reset performance of this device. The glitch width ( $V_{CC\_GW}$ ) and height ( $V_{CC\_GH}$ ) are dependent on each other. The bypass capacitance, source impedance, and device impedance are factors that affect power-on reset performance. Figure 3 and Table 2 provide more information on how to measure these specifications.

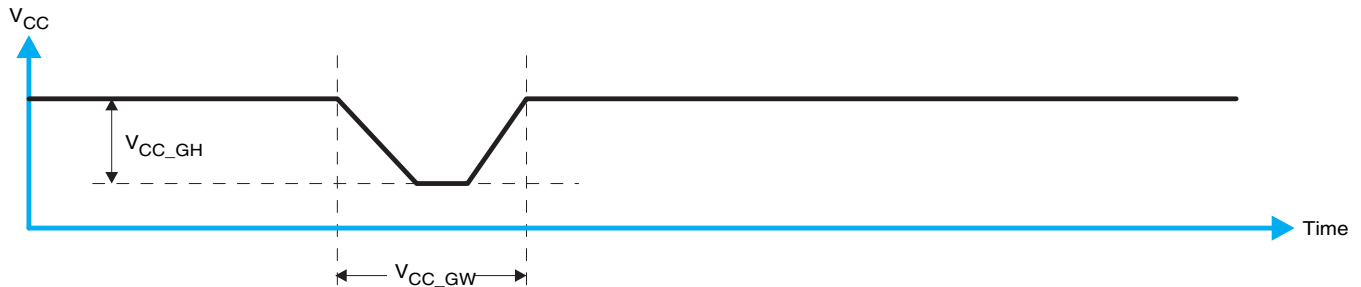

Figure 3. Glitch Width and Glitch Height

$V_{POR}$  is critical to the power-on reset.  $V_{POR}$  is the voltage level at which the reset condition is released and all the registers and the I<sup>2</sup>C/SMBus state machine are initialized to their default states. The value of  $V_{POR}$  differs based on the  $V_{CC}$  being lowered to or from 0. Figure 4 and Table 2 provide more details on this specification.

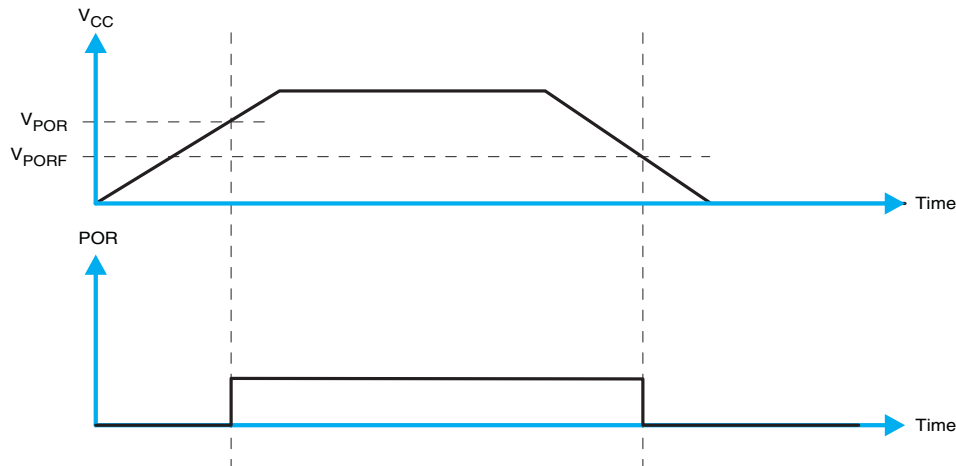

Figure 4.  $V_{POR}$

For proper operation of the power-on reset feature, use as directed in the figures and table above.

## Interrupt Output

An interrupt is generated by any rising or falling edge of the port inputs in the input mode. After time  $t_{iv}$ , the signal  $\overline{INT}$  is valid. Resetting the interrupt circuit is achieved when data on the port is changed to the original setting or data is read from the port that generated the interrupt. Resetting occurs in the read mode at the acknowledge (ACK) or not acknowledge (NACK) bit after the rising edge of the SCL signal. Interrupts that occur during the ACK or NACK clock pulse can be lost (or be very short) due to the resetting of the interrupt during this pulse. Each change of the I/Os after resetting is detected and is transmitted as  $\overline{INT}$ .

Reading from or writing to another device does not affect the interrupt circuit, and a pin configured as an output cannot cause an interrupt. Changing an I/O from an output to an input may cause a false interrupt to occur, if the state of the pin does not match the contents of the input port register.

The  $\overline{INT}$  output has an open-drain structure and requires a pullup resistor to  $V_{CC}$  depending on the application. For more information on the interrupt output feature, see [Control Register and Command Byte](#) and [Typical Applications](#).

## I<sup>2</sup>C Interface

The bidirectional I<sup>2</sup>C bus consists of the serial clock (SCL) and serial data (SDA) lines. Both lines must be connected to a positive supply through a pullup resistor when connected to the output stages of a device. Data transfer may be initiated only when the bus is not busy.

I<sup>2</sup>C communication with this device is initiated by a master sending a Start condition, a high-to-low transition on the SDA input/output, while the SCL input is high (see [Figure 5](#)). After the Start condition, the device address byte is sent, most significant bit (MSB) first, including the data direction bit ( $R/\overline{W}$ ).

After receiving the valid address byte, this device responds with an acknowledge (ACK), a low on the SDA input/output during the high of the ACK-related clock pulse. The address (ADDR) input of the slave device must not be changed between the Start and the Stop conditions.

On the I<sup>2</sup>C bus, only one data bit is transferred during each clock pulse. The data on the SDA line must remain stable during the high pulse of the clock period, as changes in the data line at this time are interpreted as control commands (Start or Stop) (see [Figure 6](#)).

A Stop condition, a low-to-high transition on the SDA input/output while the SCL input is high, is sent by the master (see [Figure 5](#)).

Any number of data bytes can be transferred from the transmitter to receiver between the Start and the Stop conditions. Each byte of eight bits is followed by one ACK bit. The transmitter must release the SDA line before the receiver can send an ACK bit. The device that acknowledges must pull down the SDA line during the ACK clock pulse, so that the SDA line is stable low during the high pulse of the ACK-related clock period (see [Figure 7](#)). When a slave receiver is addressed, it must generate an ACK after each byte is received. Similarly, the master must generate an ACK after each byte that it receives from the slave transmitter. Setup and hold times must be met to ensure proper operation.

A master receiver signals an end of data to the slave transmitter by not generating an acknowledge (NACK) after the last byte has been clocked out of the slave. This is done by the master receiver by holding the SDA line high. In this event, the transmitter must release the data line to enable the master to generate a Stop condition.

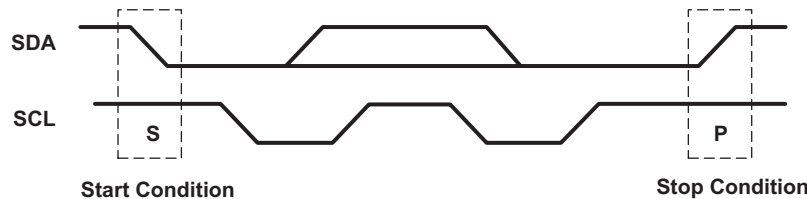

**Figure 5. Definition of Start and Stop Conditions**

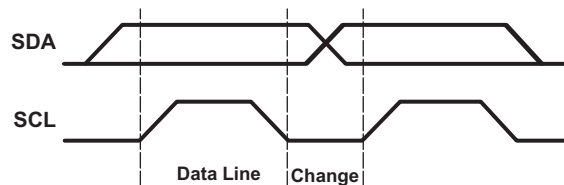

**Figure 6. Bit Transfer**

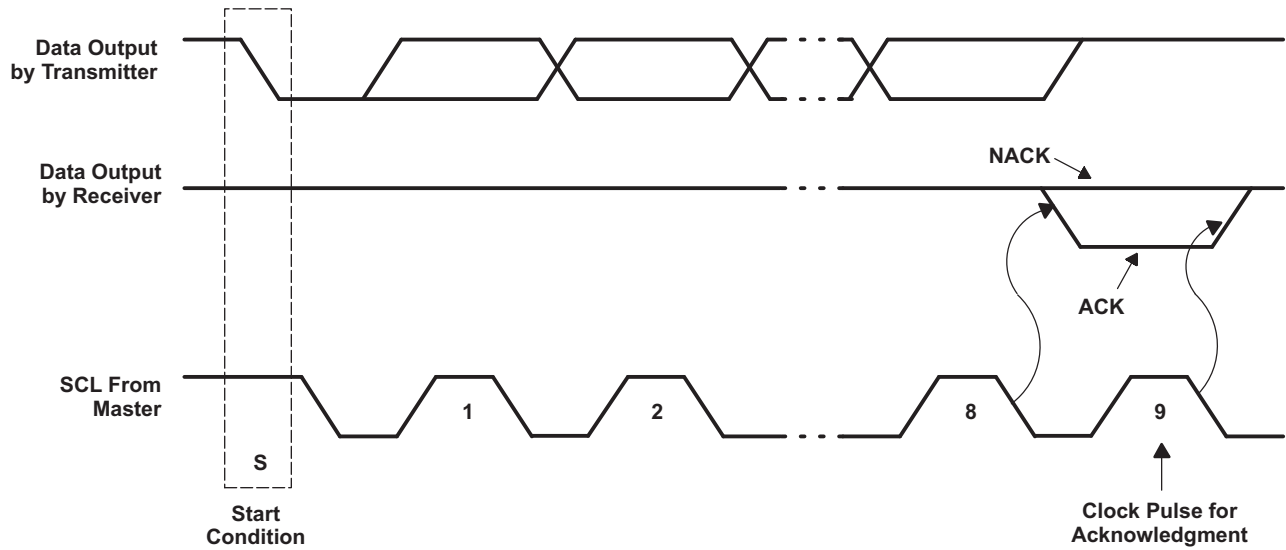

Figure 7. Acknowledgment on the I<sup>2</sup>C Bus

### Device Address

The address of the TCA6418E is shown in [Table 3](#).

Table 3.

BYTE	BIT							
	7 (MSB)	6	5	4	3	2	1	0 (LSB)
I <sup>2</sup> C slave address	0	1	1	0	1	0	0	R/W

The last bit of the slave address defines the operation (read or write) to be performed. A high (1) selects a read operation, while a low (0) selects a write operation.

## Control Register and Command Byte

Following the successful acknowledgment of the address byte, the bus master sends a command byte, which is stored in the control register in the TCA6418E. The command byte indicates the register that will be updated with information. All registers can be read and written to by the system master.

Table 4 shows all the registers within this device and their descriptions. The default value in all registers is 0.

**Table 4. Register Descriptions**

ADDRESS	REGISTER NAME	REGISTER DESCRIPTION	7	6	5	4	3	2	1	0
0x00	Reserved	Reserved								
0x01	Reserved	Reserved								
0x02	INT_STAT	Interrupt status register	N/A 0	N/A 0	N/A 0	N/A 0	N/A 0	N/A 0	GPI_IN T	N/A 0
0x03	Reserved	Reserved								
0x04	Reserved	Reserved								
0x05	Reserved	Reserved								
0x06	Reserved	Reserved								
0x07	Reserved	Reserved								
0x08	Reserved	Reserved								
0x09	Reserved	Reserved								
0x0A	Reserved	Reserved								
0x0B	Reserved	Reserved								
0x0C	Reserved	Reserved								
0x0D	Reserved	Reserved								
0x0E	Reserved	Reserved								
0x0F	Reserved	Reserved								
0x10	Reserved	Reserved								
0x11	GPIO_INT_STAT1	GPIO interrupt status	GPIO0 0	GPIO1 0	GPIO2 0	GPIO3 0	GPIO4 0	GPIO 5 0	GPIO6 0	GPIO7 0
0x12	GPIO_INT_STAT2	GPIO interrupt status	GPIO15 0	GPIO14 0	GPIO13 0	GPIO12 0	GPIO11 0	GPIO 10 0	GPIO9 0	GPIO8 0
0x13	GPIO_INT_STAT3	GPIO interrupt status	N/A 0	N/A 0	N/A 0	N/A 0	N/A 0	N/A 0	GPIO17 0	GPIO16 0
0x14	GPIO_DAT_STAT1 (read twice to clear)	GPIO data status	GPIO0 0	GPIO1 0	GPIO2 0	GPIO3 0	GPIO4 0	GPIO 5 0	GPIO6 0	GPIO7 0
0x15	GPIO_DAT_STAT2 (read twice to clear)	GPIO data status	GPIO15 0	GPIO14 0	GPIO13 0	GPIO12 0	GPIO11 0	GPIO 10 0	GPIO9 0	GPIO8 0
0x16	GPIO_DAT_STAT3 (read twice to clear)	GPIO data status	N/A 0	N/A 0	N/A 0	N/A 0	N/A 0	N/A 0	GPIO17 0	GPIO16 0
0x17	GPIO_DAT_OUT1	GPIO data out	GPIO0 0	GPIO1 0	GPIO2 0	GPIO3 0	GPIO4 0	GPIO 5 0	GPIO6 0	GPIO7 0
0x18	GPIO_DAT_OUT2	GPIO data out	GPIO15 0	GPIO14 0	GPIO13 0	GPIO12 0	GPIO11 0	GPIO 10 0	GPIO9 0	GPIO8 0
0x19	GPIO_DAT_OUT3	GPIO data out	N/A 0	N/A 0	N/A 0	N/A 0	N/A 0	N/A 0	GPIO17 0	GPIO16 0
0x1A	GPIO_INT_EN1	GPIO interrupt enable	GPIO0 0	GPIO1 0	GPIO2 0	GPIO3 0	GPIO4 0	GPIO 5 0	GPIO6 0	GPIO7 0

**Table 4. Register Descriptions (continued)**

ADDRESS	REGISTER NAME	REGISTER DESCRIPTION	7	6	5	4	3	2	1	0
0x1B	GPIO_INT_EN2	GPIO interrupt enable	GPIO15 0	GPIO14 0	GPIO13 0	GPIO12 0	GPIO11 0	GPIO 10 0	GPIO9 0	GPIO8 0
0x1C	GPIO_INT_EN3	GPIO interrupt enable	N/A 0	N/A 0	N/A 0	N/A 0	N/A 0	N/A 0	GPIO17 0	GPIO16 0
0x1D	Reserved	Reserved								
0x1E	Reserved	Reserved								
0x1F	Reserved	Reserved								
0x20	Reserved	Reserved								
0x21	Reserved	Reserved								
0x22	Reserved	Reserved								
0x23	GPIO_DIR1	GPIO data direction 0: input 1: output	GPIO0 0	GPIO1 0	GPIO2 0	GPIO3 0	GPIO4 0	GPIO 5 0	GPIO6 0	GPIO7 0
0x24	GPIO_DIR2	GPIO data direction 0: input 1: output	GPIO15 0	GPIO14 0	GPIO13 0	GPIO12 0	GPIO11 0	GPIO 10 0	GPIO9 0	GPIO8 0
0x25	GPIO_DIR3	GPIO data direction 0: input 1: output	N/A 0	N/A 0	N/A 0	N/A 0	N/A 0	N/A 0	GPIO17 0	GPIO16 0
0x26	GPIO_INT_LVL 1	GPIO edge/level detect 0: low 1: high	GPIO0 0	GPIO1 0	GPIO2 0	GPIO3 0	GPIO4 0	GPIO 5 0	GPIO6 0	GPIO7 0
0x27	GPIO_INT_LVL 2	GPIO edge/level detect 0: low 1: high	GPIO15 0	GPIO14 0	GPIO13 0	GPIO12 0	GPIO11 0	GPIO 10 0	GPIO9 0	GPIO8 0
0x28	GPIO_INT_LVL 3	GPIO edge/level detect 0: low 1: high	N/A 0	N/A 0	N/A 0	N/A 0	N/A 0	N/A 0	GPIO17 0	GPIO16 0
0x29	DEBOUNCE_DIS 1	Debounce disable 0: enabled 1: disabled	GPIO0 0	GPIO1 0	GPIO2 0	GPIO3 0	GPIO4 0	GPIO 5 0	GPIO6 0	GPIO7 0
0x2A	DEBOUNCE_DIS 2	Debounce disable 0: enabled 1: disabled	GPIO15 0	GPIO14 0	GPIO13 0	GPIO12 0	GPIO11 0	GPIO 10 0	GPIO9 0	GPIO8 0
0x2B	DEBOUNCE_DIS 3	Debounce disable 0: enabled 1: disabled	N/A 0	N/A 0	N/A 0	N/A 0	N/A 0	N/A 0	GPIO17 0	GPIO16 0
0x2C	GPIO_PULL1	GPIO pulldown 0: pulldown enabled 1: pulldown disabled	GPIO0 0	GPIO1 0	GPIO2 0	GPIO3 0	GPIO4 0	GPIO 5 0	GPIO6 0	GPIO7 0
0x2D	GPIO_PULL2	GPIO pulldown 0: pulldown enabled 1: pulldown disabled	GPIO15 0	GPIO14 0	GPIO13 0	GPIO12 0	GPIO11 0	GPIO 10 0	GPIO9 0	GPIO8 0
0x2E	GPIO_PULL3	GPIO pulldown 0: pulldown enabled 1: pulldown disabled	N/A 0	N/A 0	N/A 0	N/A 0	N/A 0	N/A 0	GPIO17 0	GPIO16 0
0x2F	Reserved									

### Interrupt Status Register, INT\_STAT (Address 0x02)

GPI\_INT (BIT1) reflects the status of the  $\overline{\text{INT}}$  pin. If GPI\_INT is 1,  $\overline{\text{INT}}$  is asserted. Write 0x02 to INT\_STAT register to clear interrupt.

### GPIO Interrupt Status Registers, GPIO\_INT\_STAT1–3 (Address 0x11–0x13)

These registers are used to check GPIO interrupt status and are cleared on read.

### GPIO Data Status Registers, GPIO\_DAT\_STAT1–3 (Address 0x14–0x16)

These registers show GPIO state when read for inputs and outputs.

### GPIO Data Out Registers, GPIO\_DAT\_OUT1–3 (Address 0x17–0x19)

These registers contain GPIO data to be written to GPIO out driver; inputs are not affected. This is needed so that the value can be written prior to being set as an output.

### GPIO Interrupt Enable Registers, GPIO\_INT\_EN1–3 (Address 0x1A–0x1C)

These registers enable interrupts for GP inputs only.

### GPIO Data Direction Registers, GPIO\_DIR1–3 (Address 0x23–0x25)

A bit value of '0' in any of the unreserved bits sets the corresponding pin as an input. A '1' in any of these bits sets the pin as an output.

### GPIO Edge/Level Detect Registers, GPIO\_INT\_LVL1–3 (Address 0x26–0x28)

A bit value of '0' indicates that interrupt will be triggered on a high-to-low transition for the inputs in GPIO mode. A bit value of '1' indicates that interrupt will be triggered on a low-to-high value for the inputs in GPIO mode.

### Debounce Disable Registers, DEBOUNCE\_DIS1–3 (Address 0x29–0x2B)

This is for pins configured as inputs. A bit value of '0' in any of the unreserved bits enables the debounce while a bit value of '1' disables the debounce.

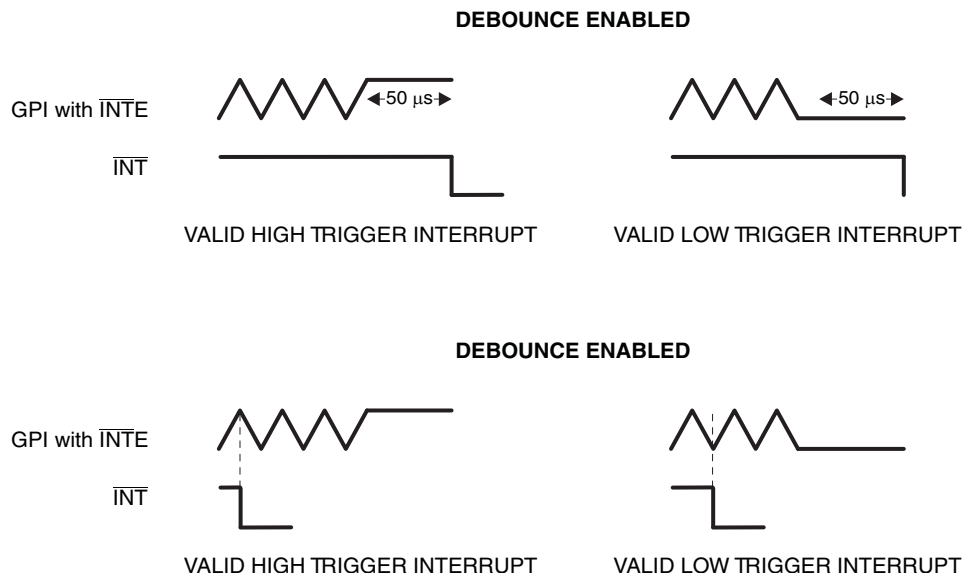

The reset line always has a 50- $\mu$ s debounce time.

The 50  $\mu$ s debounce time for inputs is the time required for the input to be stable to be noticed.

### GPIO Pull Disable Register, GPIO\_PULL1–3 (Address 0x2C–0x2E)

This register enables or disables pulldown registers from inputs.

## Bus Transactions

Data is exchanged between the master and TCA6418E through write and read commands.

### Writes

Data is transmitted to the TCA6418E by sending the device address and setting the least significant bit (LSB) to a logic 0. The command byte is sent after the address and determines which register receives the data that follows the command byte. There is no limitation on the number of data bytes sent in one write transmission.

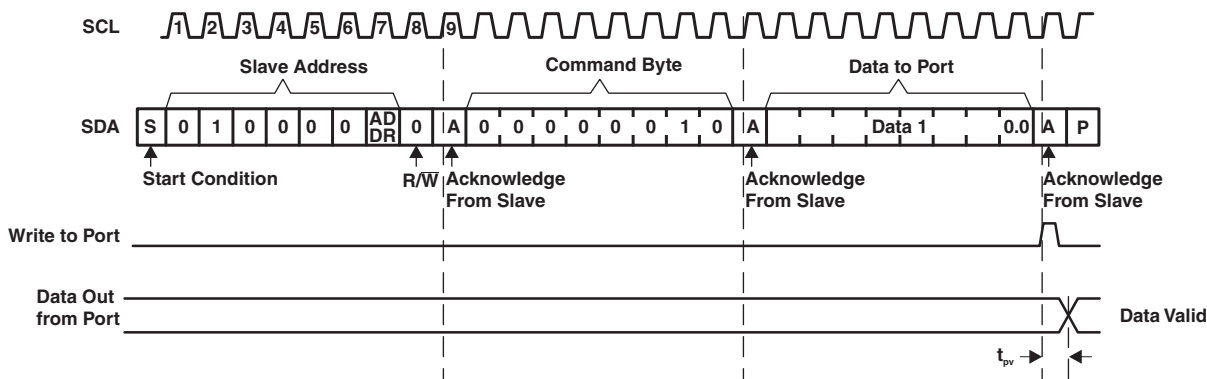

Figure 8. Write to Output Port Register

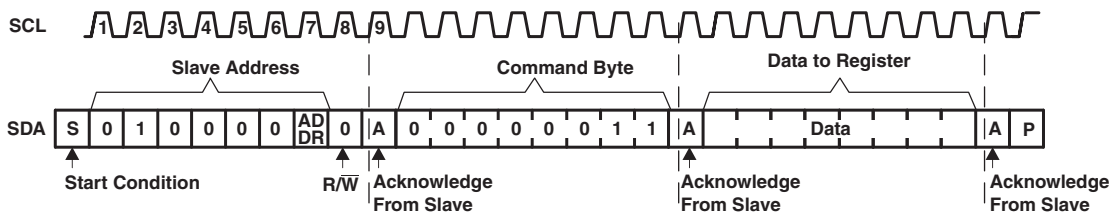

Figure 9. Write to Configuration or Polarity Inversion Register

### Reads

The bus master first must send the TCA6418E address with the LSB set to a logic 0. The command byte is sent after the address and determines which register is accessed. After a restart, the device address is sent again but, this time, the LSB is set to a logic 1. Data from the register defined by the command byte then is sent by the TCA6418E (see Figure 10 and Figure 11). Data is clocked into the register on the rising edge of the ACK clock pulse.

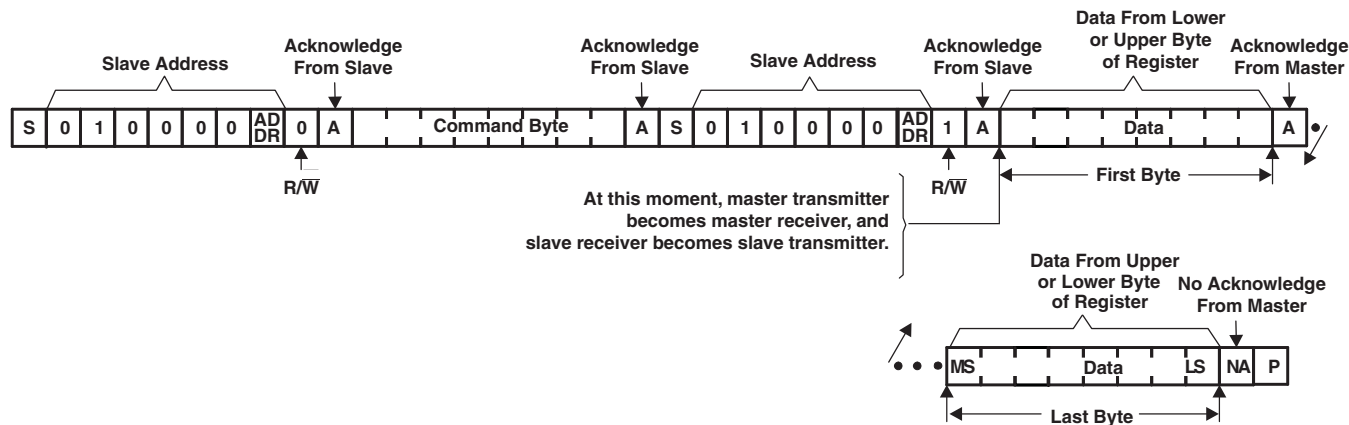

Figure 10. Read From Register

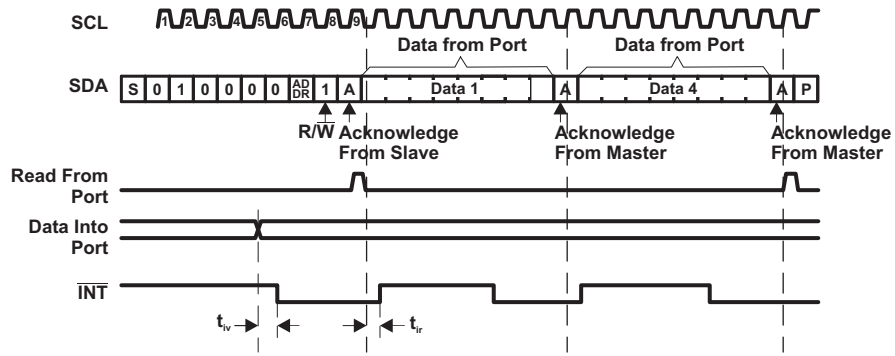

Figure 11. Read From Input Port Register



### TYPICAL CHARACTERISTICS

$T_A = 25^\circ\text{C}$  (unless otherwise noted)

**SUPPLY CURRENT  
vs  
TEMPERATURE**

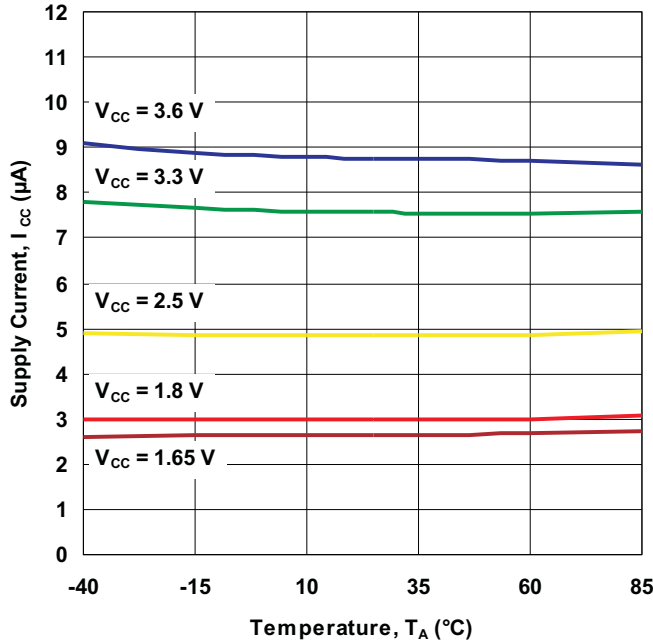

**STANDBY SUPPLY CURRENT  
vs  
TEMPERATURE**

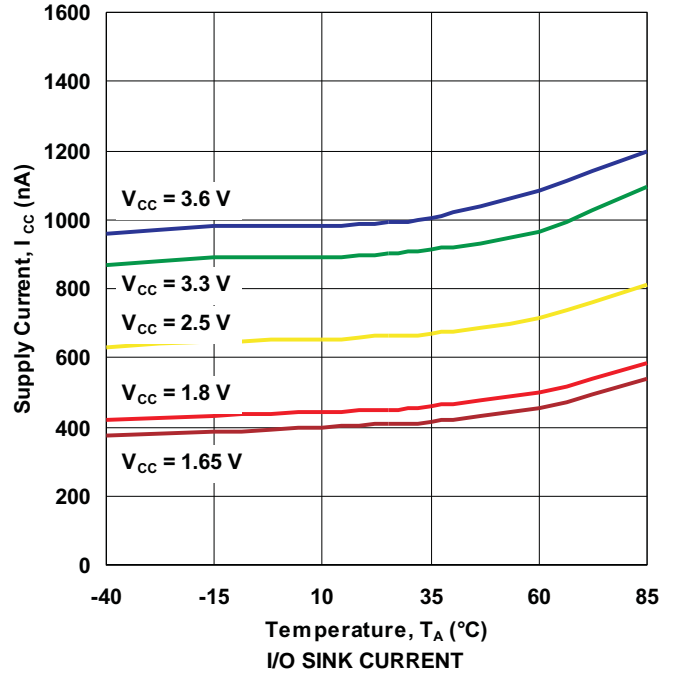

**SUPPLY CURRENT  
vs  
SUPPLY VOLTAGE**

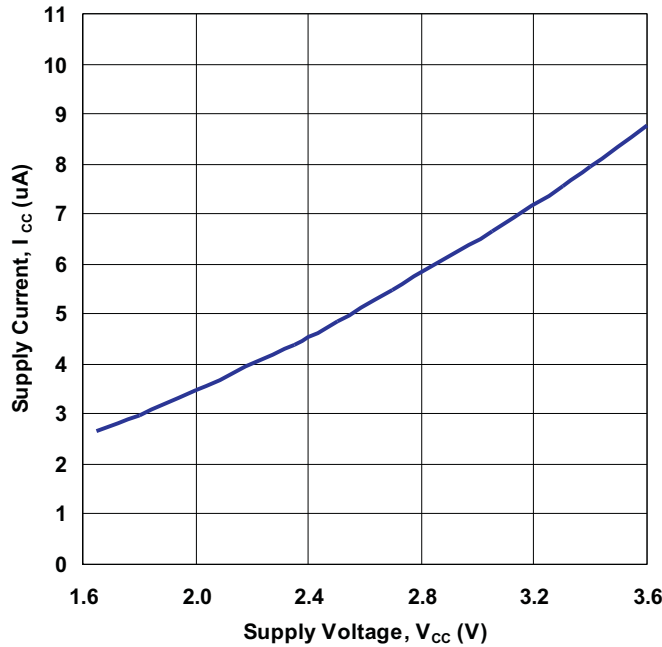

**OUTPUT LOW VOLTAGE  
vs  
I/O SINK CURRENT**

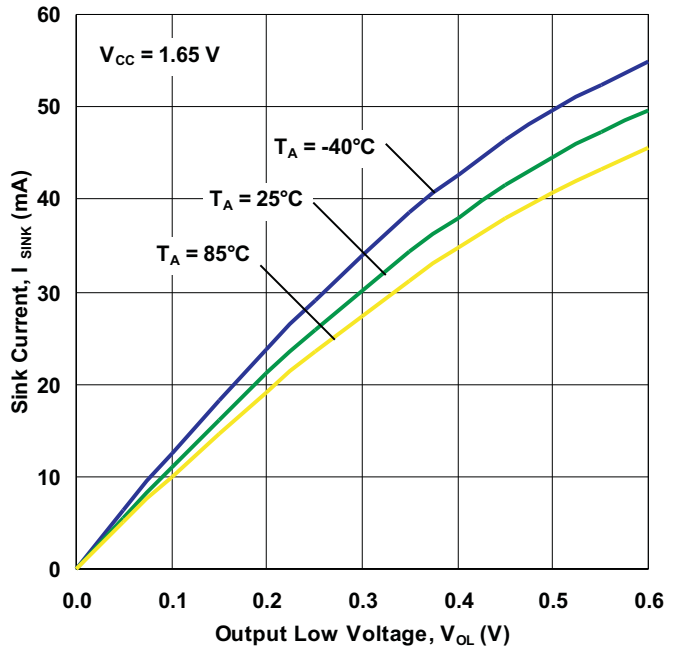

**TYPICAL CHARACTERISTICS (continued)**

$T_A = 25^\circ\text{C}$  (unless otherwise noted)

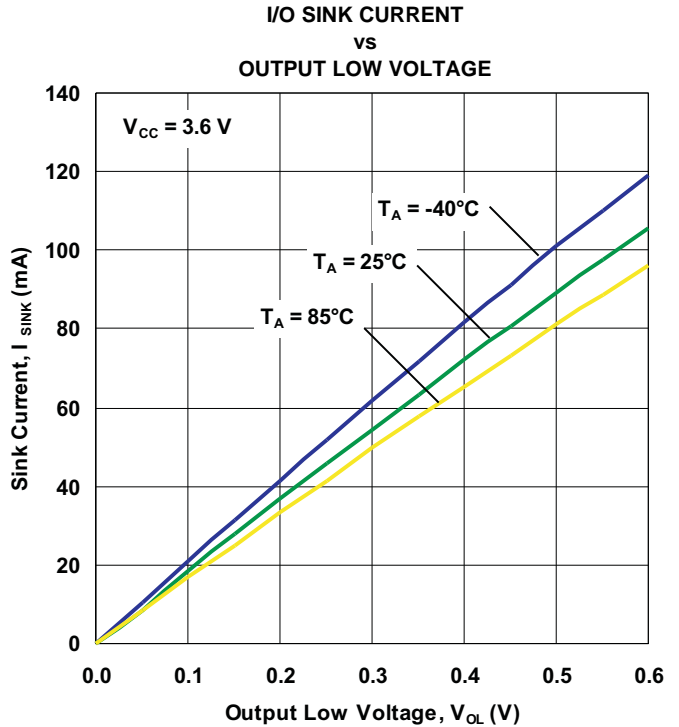
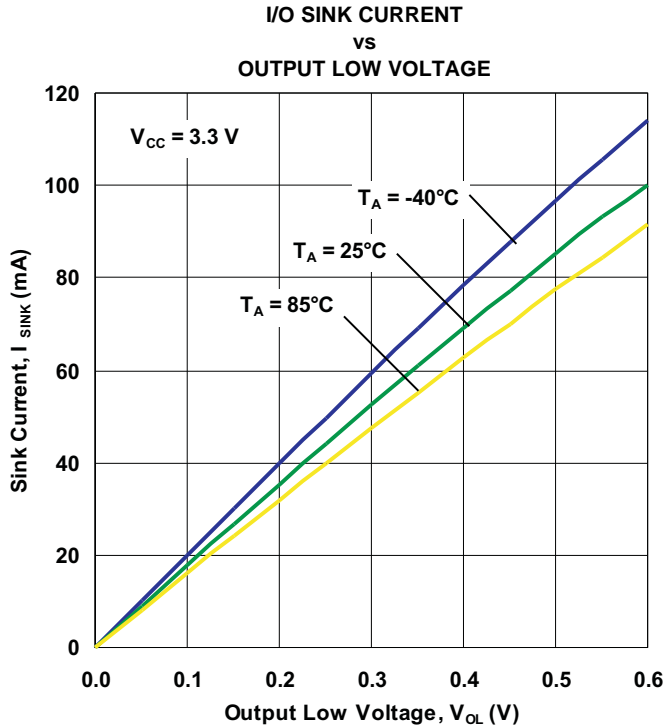
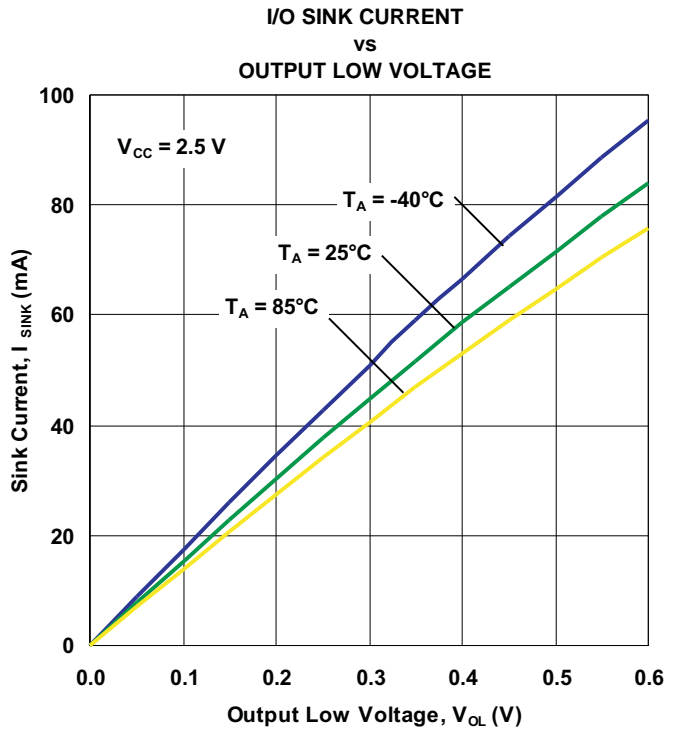
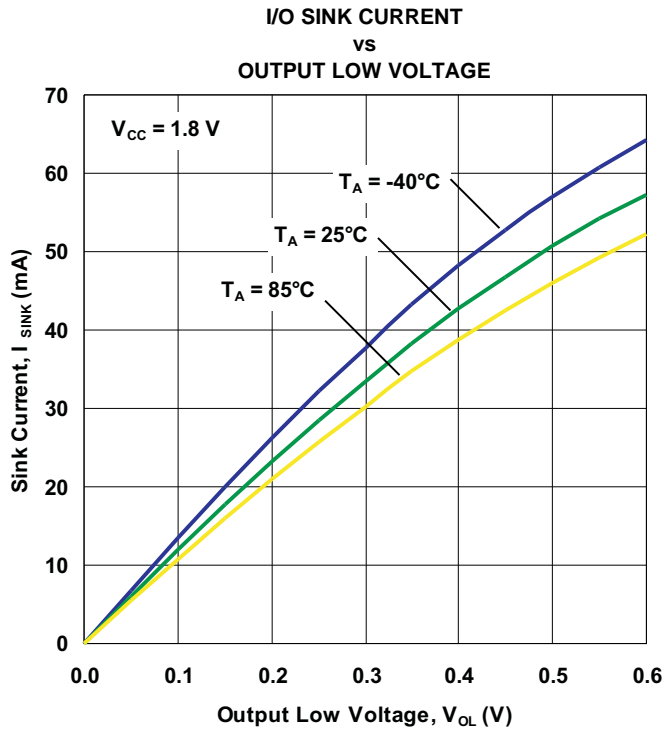

TYPICAL CHARACTERISTICS (continued)

T<sub>A</sub> = 25°C (unless otherwise noted)

I/O LOW VOLTAGE  
vs  
TEMPERATURE

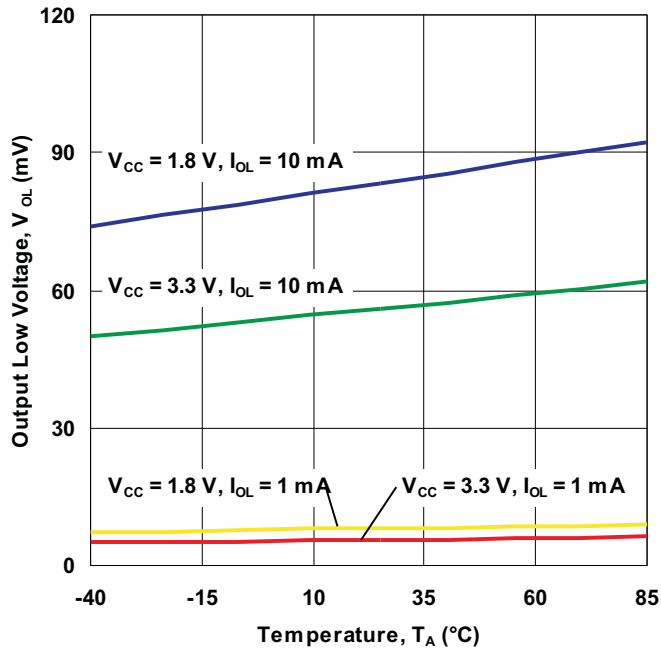

I/O SOURCE CURRENT  
vs  
OUTPUT HIGH VOLTAGE

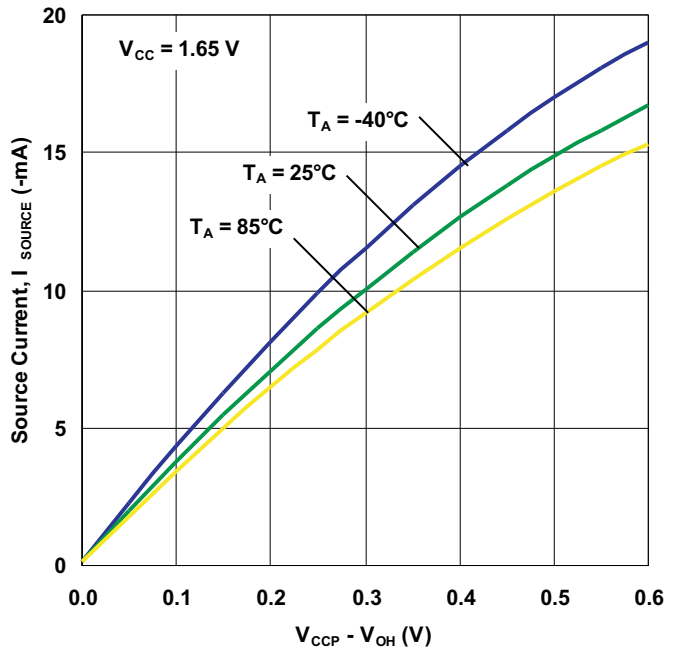

I/O SOURCE CURRENT  
vs  
OUTPUT HIGH VOLTAGE

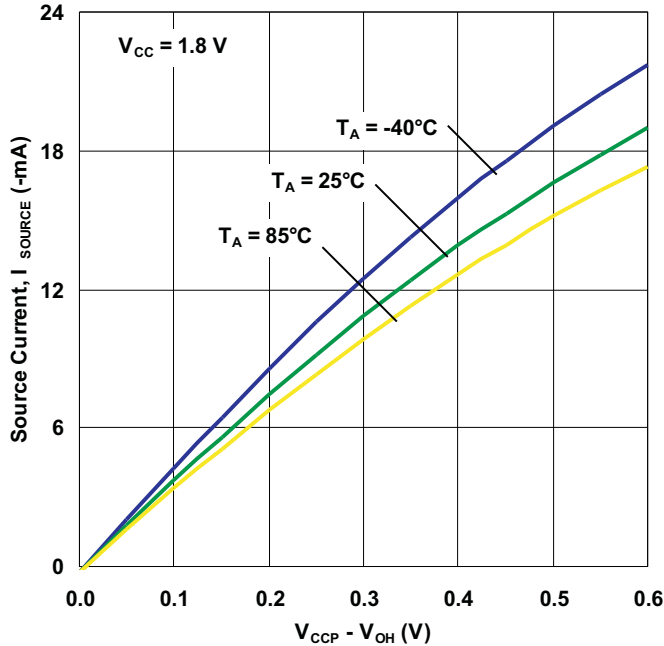

I/O SOURCE CURRENT  
vs  
OUTPUT HIGH VOLTAGE

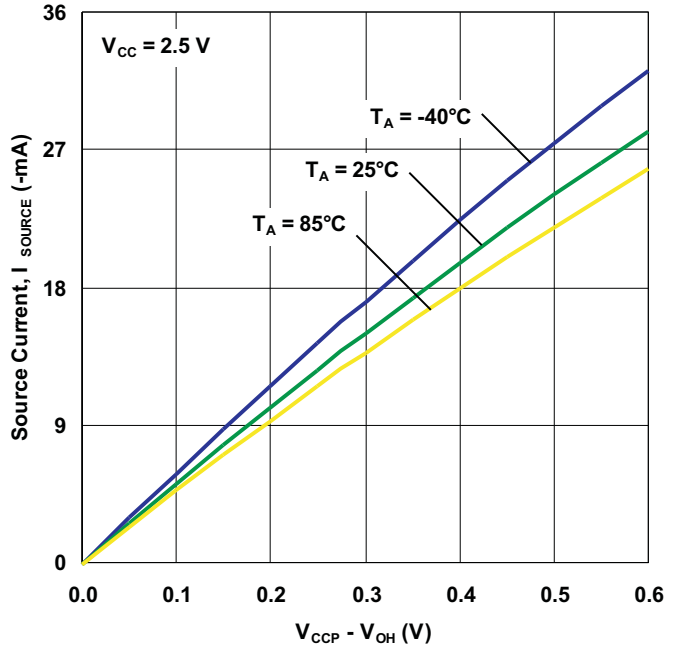

**TYPICAL CHARACTERISTICS (continued)**

$T_A = 25^\circ\text{C}$  (unless otherwise noted)

**I/O SOURCE CURRENT  
vs  
OUTPUT HIGH VOLTAGE**

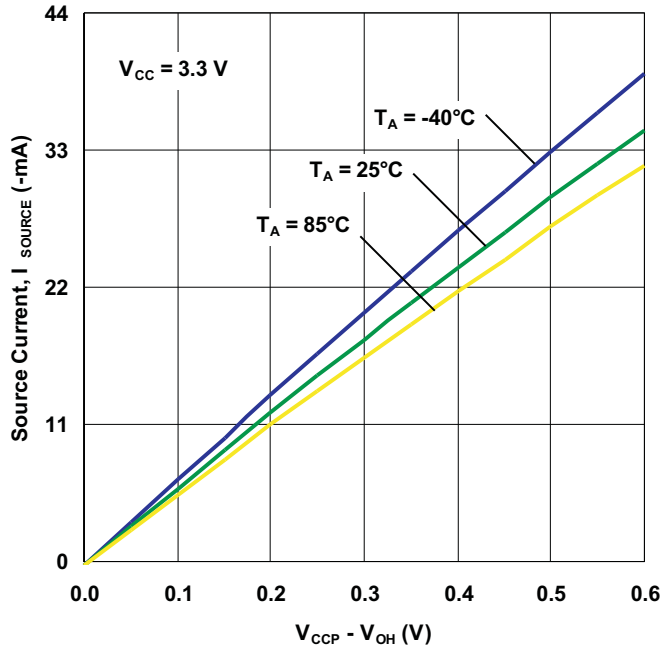

**I/O SOURCE CURRENT  
vs  
OUTPUT HIGH VOLTAGE**

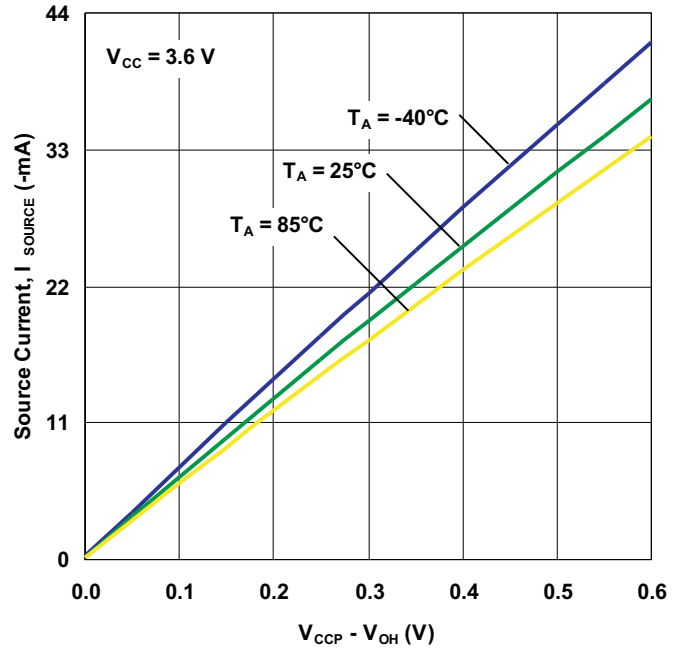

**I/O HIGH VOLTAGE  
vs  
TEMPERATURE**

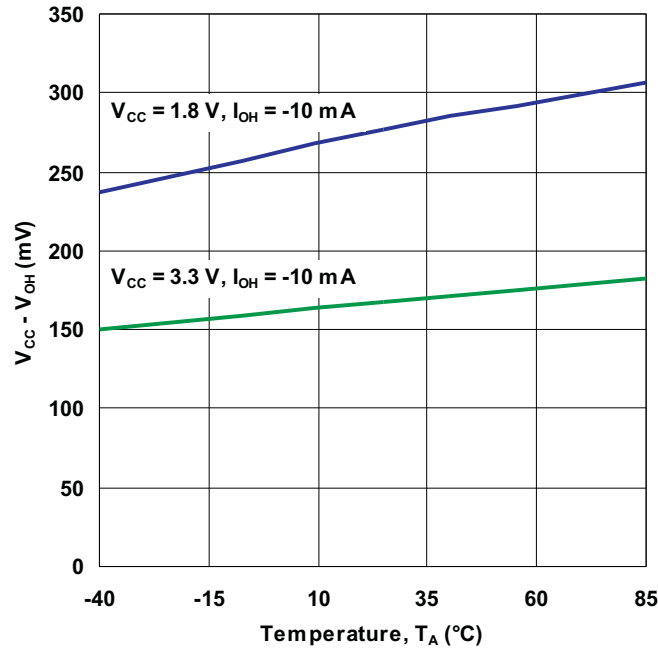

PARAMETER MEASUREMENT INFORMATION

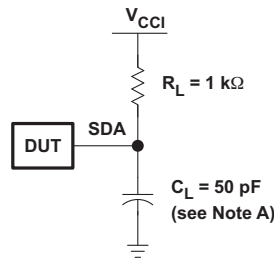

SDA LOAD CONFIGURATION

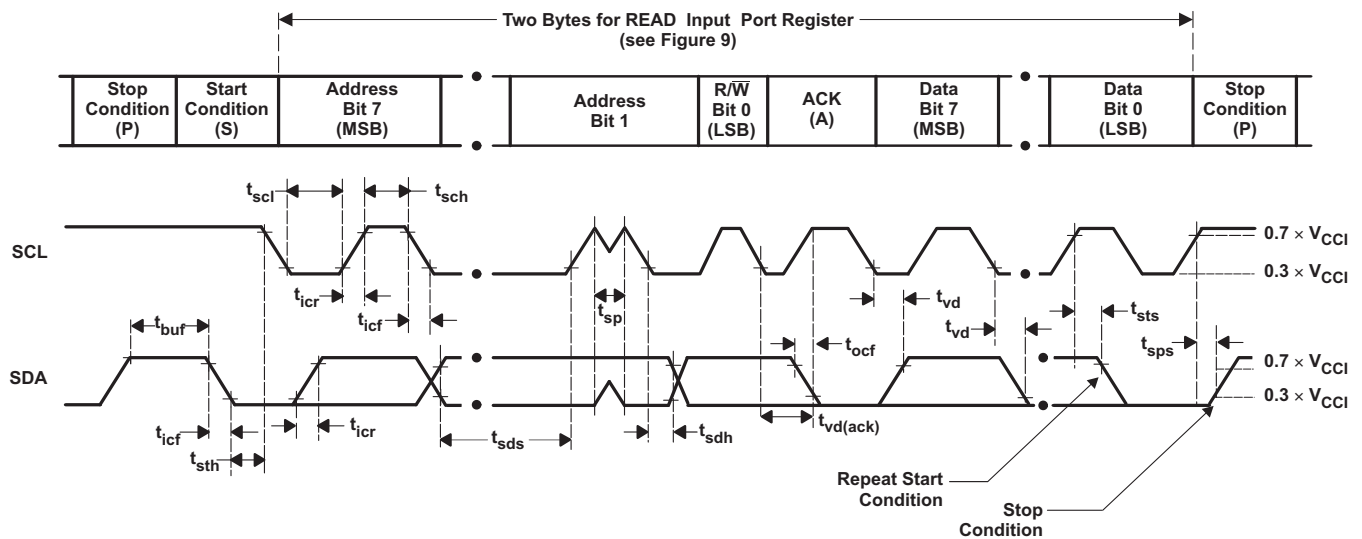

VOLTAGE WAVEFORMS

BYTE	DESCRIPTION
1	I <sup>2</sup> C address
2	Input register port data

- A.  $C_L$  includes probe and jig capacitance.  $t_{ocf}$  is measured with  $C_L$  of 10 pF or 400 pF.
- B. All inputs are supplied by generators having the following characteristics: PRR  $\leq$  10 MHz,  $Z_O = 50 \Omega$ ,  $t_r/t_f \leq 30$  ns.
- C. All parameters and waveforms are not applicable to all devices.

Figure 12. I<sup>2</sup>C Interface Load Circuit and Voltage Waveforms

PARAMETER MEASUREMENT INFORMATION (continued)

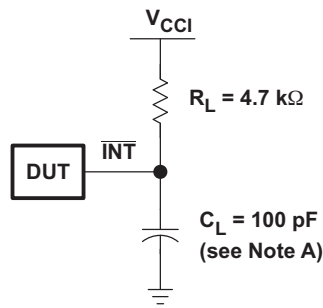

INTERRUPT LOAD CONFIGURATION

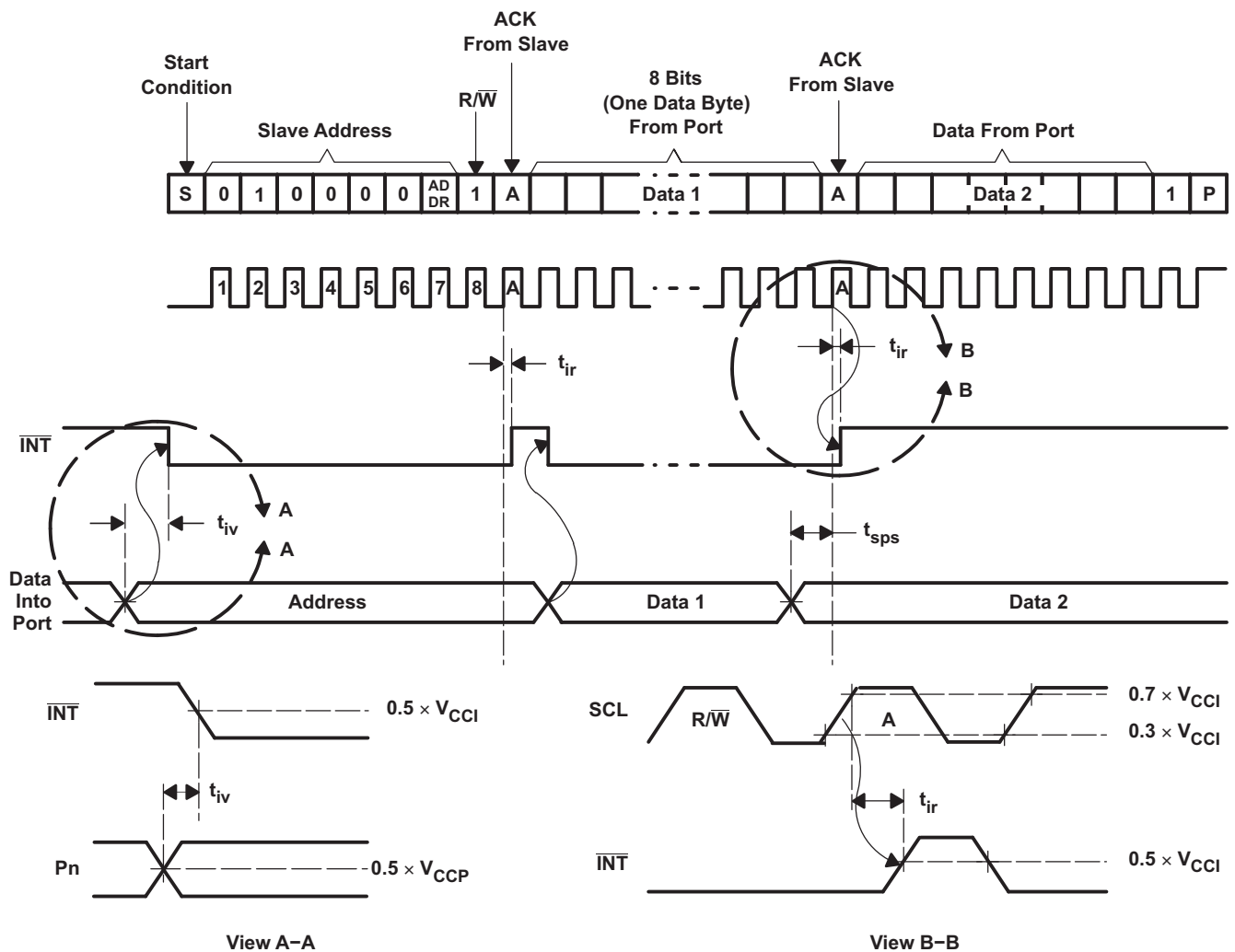

- A.  $C_L$  includes probe and jig capacitance.
- B. All inputs are supplied by generators having the following characteristics:  $PRR \leq 10$  MHz,  $Z_O = 50 \Omega$ ,  $t_r/t_f \leq 30$  ns.
- C. All parameters and waveforms are not applicable to all devices.

Figure 13. Interrupt Load Circuit and Voltage Waveforms

PARAMETER MEASUREMENT INFORMATION (continued)

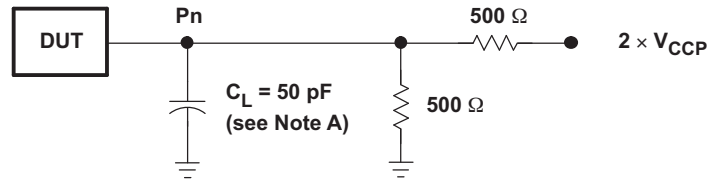

P-PORT LOAD CONFIGURATION

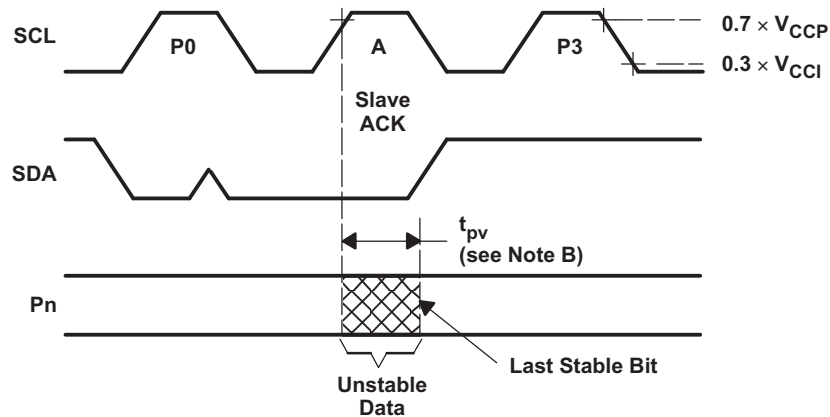

WRITE MODE ( $R/\bar{W} = 0$ )

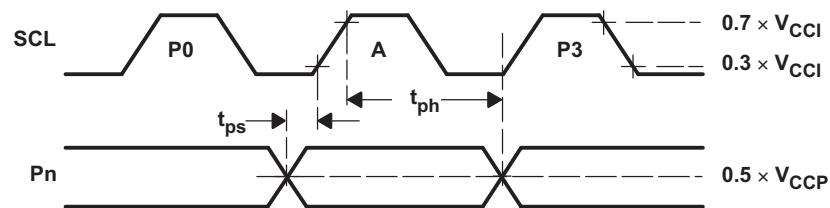

READ MODE ( $R/\bar{W} = 1$ )

- A.  $C_L$  includes probe and jig capacitance.
- B.  $t_{pv}$  is measured from  $0.7 \times V_{CC}$  on SCL to 50% I/O (Pn) output.
- C. All inputs are supplied by generators having the following characteristics: PRR  $\leq 10 \text{ MHz}$ ,  $Z_0 = 50 \Omega$ ,  $t_r/t_f \leq 30 \text{ ns}$ .
- D. The outputs are measured one at a time, with one transition per measurement.
- E. All parameters and waveforms are not applicable to all devices.

Figure 14. P Port Load Circuit and Timing Waveforms

PARAMETER MEASUREMENT INFORMATION (continued)

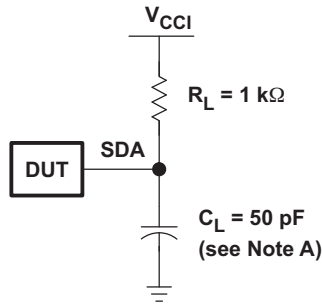

SDA LOAD CONFIGURATION

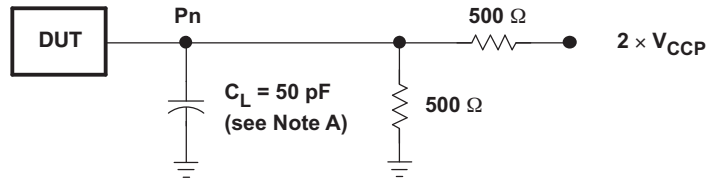

P-PORT LOAD CONFIGURATION

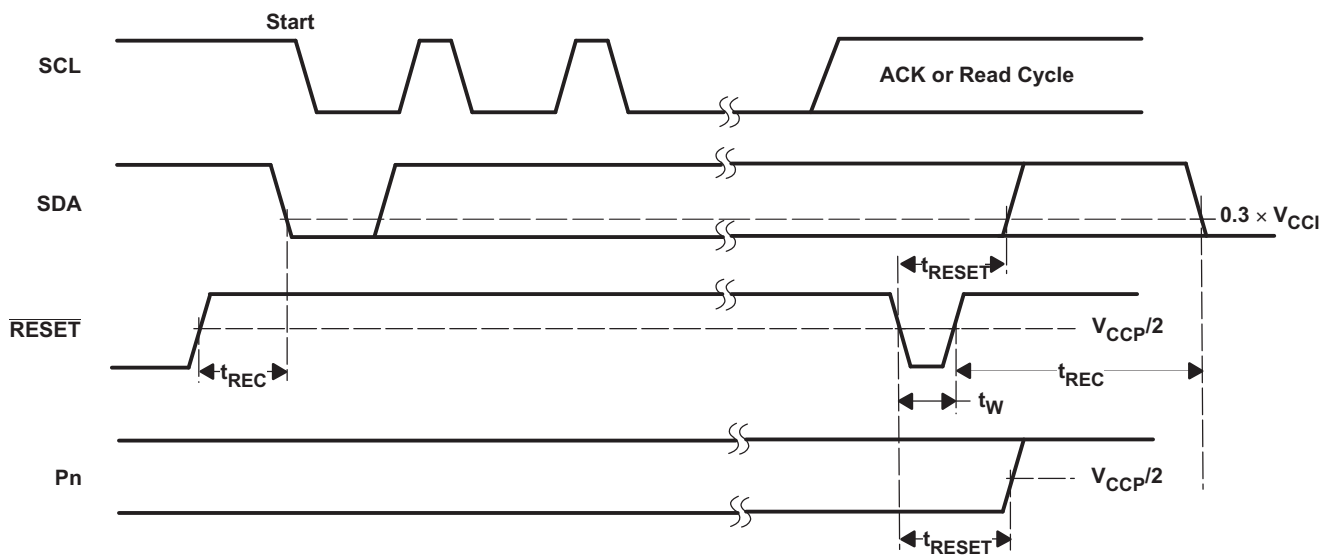

- A.  $C_L$  includes probe and jig capacitance.
- B. All inputs are supplied by generators having the following characteristics:  $PRR \leq 10\text{ MHz}$ ,  $Z_O = 50\ \Omega$ ,  $t_r/t_f \leq 30\text{ ns}$ .
- C. The outputs are measured one at a time, with one transition per measurement.
- D. I/Os are configured as inputs.
- E. All parameters and waveforms are not applicable to all devices.

Figure 15. Reset Load Circuits and Voltage Waveforms



**PACKAGING INFORMATION**

Orderable Device	Status (1)	Package Type	Package Drawing	Pins	Package Qty	Eco Plan (2)	Lead finish/ Ball material (6)	MSL Peak Temp (3)	Op Temp (°C)	Device Marking (4/5)	Samples
TCA6418EYFPR	ACTIVE	DSBGA	YFP	25	3000	RoHS & Green	SNAGCU	Level-1-260C-UNLIM	-40 to 85	(AZ2, AZN)	<b>Samples</b>

(1) The marketing status values are defined as follows:

**ACTIVE:** Product device recommended for new designs.

**LIFEBUY:** TI has announced that the device will be discontinued, and a lifetime-buy period is in effect.

**NRND:** Not recommended for new designs. Device is in production to support existing customers, but TI does not recommend using this part in a new design.

**PREVIEW:** Device has been announced but is not in production. Samples may or may not be available.

**OBSELETE:** TI has discontinued the production of the device.

(2) **RoHS:** TI defines "RoHS" to mean semiconductor products that are compliant with the current EU RoHS requirements for all 10 RoHS substances, including the requirement that RoHS substance do not exceed 0.1% by weight in homogeneous materials. Where designed to be soldered at high temperatures, "RoHS" products are suitable for use in specified lead-free processes. TI may reference these types of products as "Pb-Free".

**RoHS Exempt:** TI defines "RoHS Exempt" to mean products that contain lead but are compliant with EU RoHS pursuant to a specific EU RoHS exemption.

**Green:** TI defines "Green" to mean the content of Chlorine (Cl) and Bromine (Br) based flame retardants meet JS709B low halogen requirements of <=1000ppm threshold. Antimony trioxide based flame retardants must also meet the <=1000ppm threshold requirement.

(3) MSL, Peak Temp. - The Moisture Sensitivity Level rating according to the JEDEC industry standard classifications, and peak solder temperature.

(4) There may be additional marking, which relates to the logo, the lot trace code information, or the environmental category on the device.

(5) Multiple Device Markings will be inside parentheses. Only one Device Marking contained in parentheses and separated by a "-" will appear on a device. If a line is indented then it is a continuation of the previous line and the two combined represent the entire Device Marking for that device.

(6) Lead finish/Ball material - Orderable Devices may have multiple material finish options. Finish options are separated by a vertical ruled line. Lead finish/Ball material values may wrap to two lines if the finish value exceeds the maximum column width.

**Important Information and Disclaimer:**The information provided on this page represents TI's knowledge and belief as of the date that it is provided. TI bases its knowledge and belief on information provided by third parties, and makes no representation or warranty as to the accuracy of such information. Efforts are underway to better integrate information from third parties. TI has taken and continues to take reasonable steps to provide representative and accurate information but may not have conducted destructive testing or chemical analysis on incoming materials and chemicals. TI and TI suppliers consider certain information to be proprietary, and thus CAS numbers and other limited information may not be available for release.

In no event shall TI's liability arising out of such information exceed the total purchase price of the TI part(s) at issue in this document sold by TI to Customer on an annual basis.

## TAPE AND REEL INFORMATION



### QUADRANT ASSIGNMENTS FOR PIN 1 ORIENTATION IN TAPE



\*All dimensions are nominal

Device	Package Type	Package Drawing	Pins	SPQ	Reel Diameter (mm)	Reel Width W1 (mm)	A0 (mm)	B0 (mm)	K0 (mm)	P1 (mm)	W (mm)	Pin1 Quadrant
TCA6418EYFPR	DSBGA	YFP	25	3000	178.0	9.2	2.09	2.09	0.62	4.0	8.0	Q1

**TAPE AND REEL BOX DIMENSIONS**

\*All dimensions are nominal

Device	Package Type	Package Drawing	Pins	SPQ	Length (mm)	Width (mm)	Height (mm)
TCA6418EYFPR	DSBGA	YFP	25	3000	220.0	220.0	35.0

YFP0025

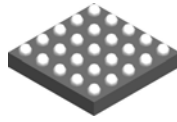

PACKAGE OUTLINE

DSBGA - 0.5 mm max height

DIE SIZE BALL GRID ARRAY

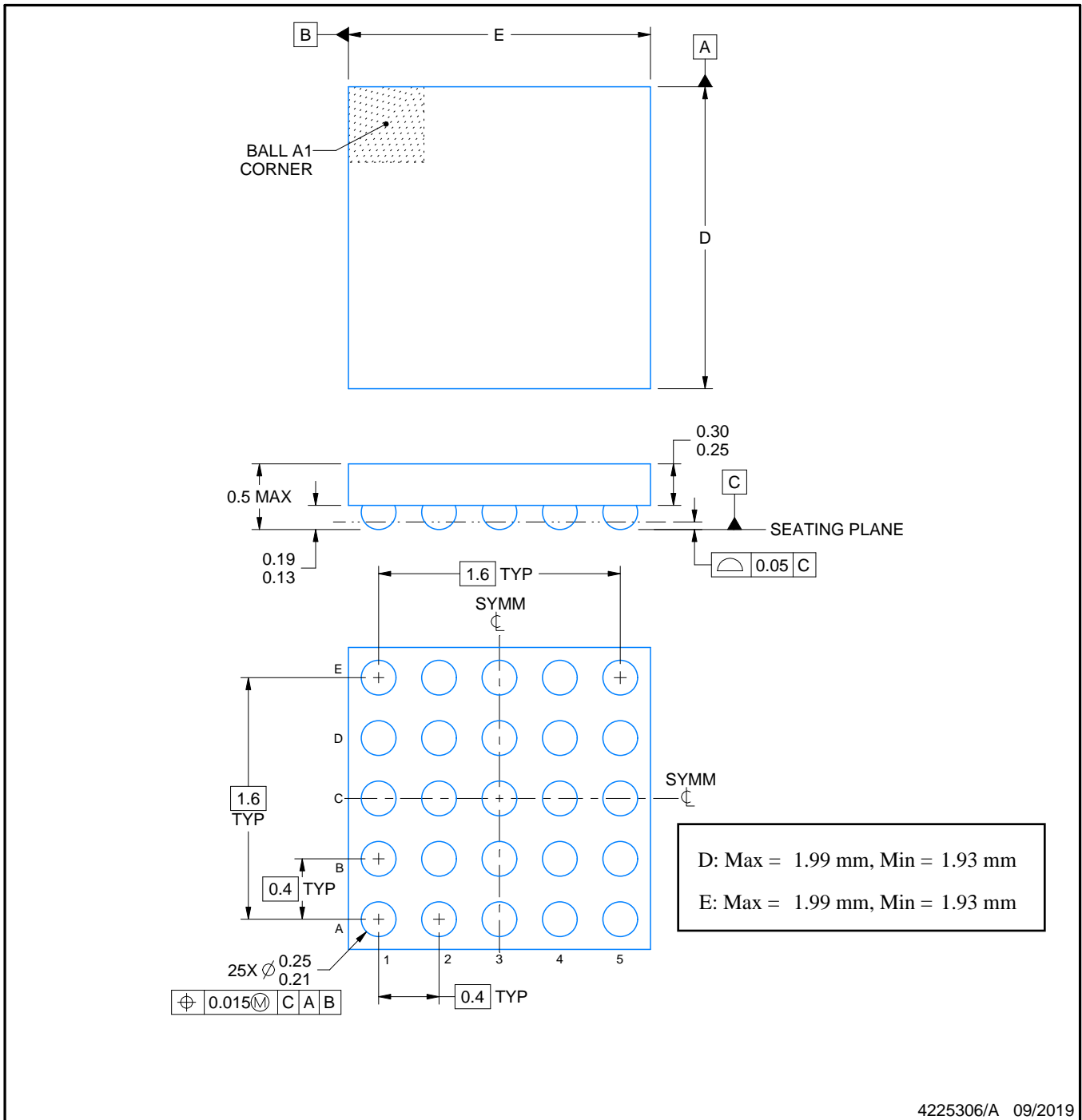

NOTES:

1. All linear dimensions are in millimeters. Any dimensions in parenthesis are for reference only. Dimensioning and tolerancing per ASME Y14.5M.
2. This drawing is subject to change without notice.

# EXAMPLE BOARD LAYOUT

YFP0025

DSBGA - 0.5 mm max height

DIE SIZE BALL GRID ARRAY

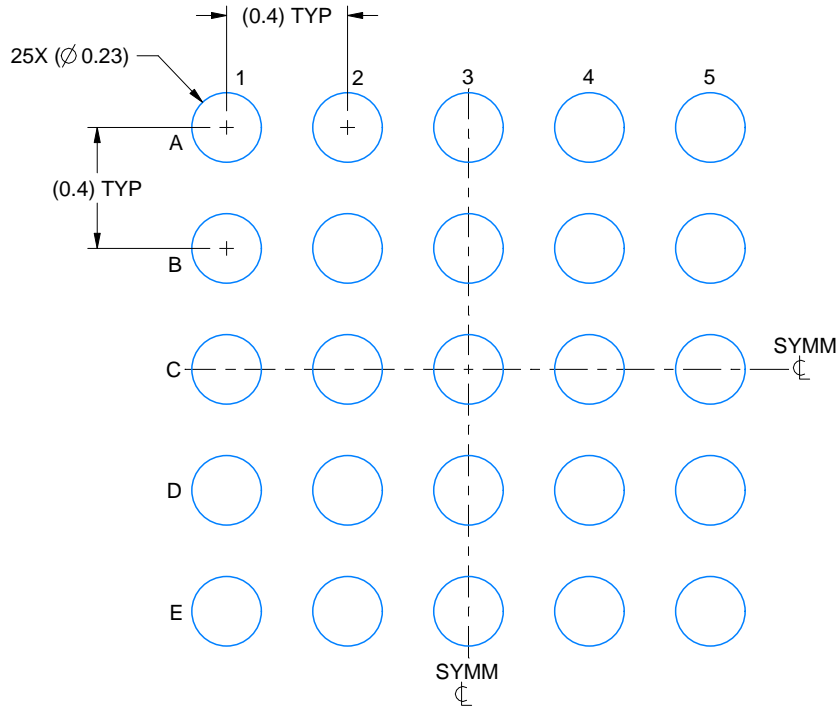

LAND PATTERN EXAMPLE  
EXPOSED METAL SHOWN  
SCALE: 40X

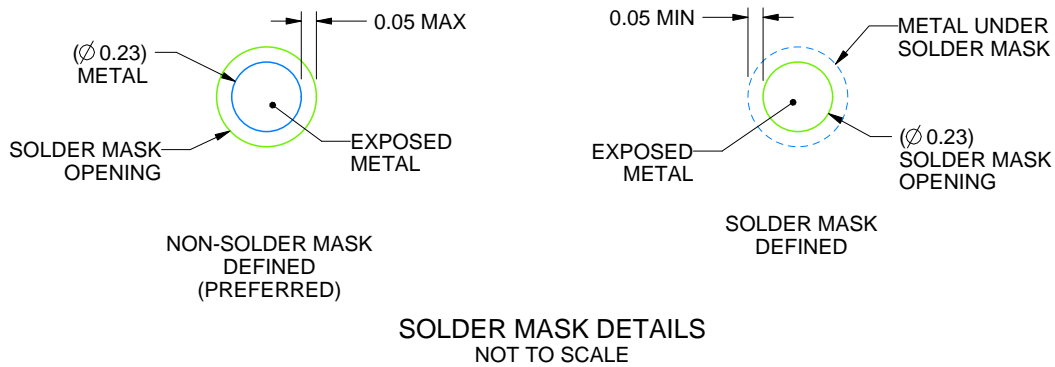

SOLDER MASK DETAILS  
NOT TO SCALE

4225306/A 09/2019

NOTES: (continued)

- Final dimensions may vary due to manufacturing tolerance considerations and also routing constraints. See Texas Instruments Literature No. SNVA009 ([www.ti.com/lit/snva009](http://www.ti.com/lit/snva009)).

# EXAMPLE STENCIL DESIGN

YFP0025

DSBGA - 0.5 mm max height

DIE SIZE BALL GRID ARRAY

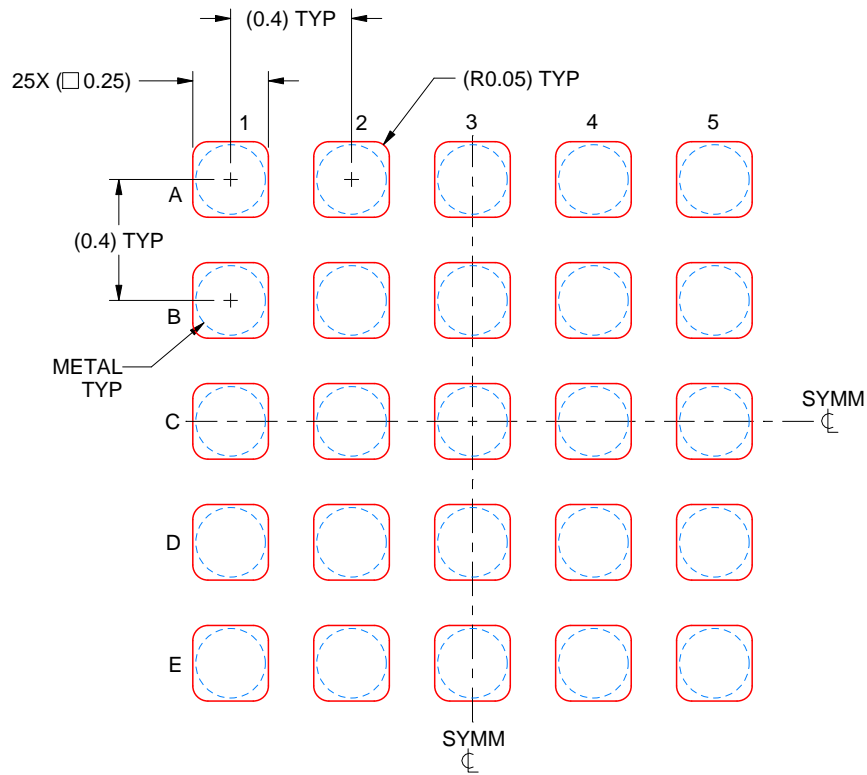

SOLDER PASTE EXAMPLE  
BASED ON 0.1 mm THICK STENCIL  
SCALE: 40X

4225306/A 09/2019

NOTES: (continued)

4. Laser cutting apertures with trapezoidal walls and rounded corners may offer better paste release.

## IMPORTANT NOTICE AND DISCLAIMER

TI PROVIDES TECHNICAL AND RELIABILITY DATA (INCLUDING DATA SHEETS), DESIGN RESOURCES (INCLUDING REFERENCE DESIGNS), APPLICATION OR OTHER DESIGN ADVICE, WEB TOOLS, SAFETY INFORMATION, AND OTHER RESOURCES "AS IS" AND WITH ALL FAULTS, AND DISCLAIMS ALL WARRANTIES, EXPRESS AND IMPLIED, INCLUDING WITHOUT LIMITATION ANY IMPLIED WARRANTIES OF MERCHANTABILITY, FITNESS FOR A PARTICULAR PURPOSE OR NON-INFRINGEMENT OF THIRD PARTY INTELLECTUAL PROPERTY RIGHTS.

These resources are intended for skilled developers designing with TI products. You are solely responsible for (1) selecting the appropriate TI products for your application, (2) designing, validating and testing your application, and (3) ensuring your application meets applicable standards, and any other safety, security, regulatory or other requirements.

These resources are subject to change without notice. TI grants you permission to use these resources only for development of an application that uses the TI products described in the resource. Other reproduction and display of these resources is prohibited. No license is granted to any other TI intellectual property right or to any third party intellectual property right. TI disclaims responsibility for, and you will fully indemnify TI and its representatives against, any claims, damages, costs, losses, and liabilities arising out of your use of these resources.

TI's products are provided subject to [TI's Terms of Sale](#) or other applicable terms available either on [ti.com](http://ti.com) or provided in conjunction with such TI products. TI's provision of these resources does not expand or otherwise alter TI's applicable warranties or warranty disclaimers for TI products.

TI objects to and rejects any additional or different terms you may have proposed.

Mailing Address: Texas Instruments, Post Office Box 655303, Dallas, Texas 75265  
Copyright © 2022, Texas Instruments Incorporated