

# TL7757 SUPPLY-VOLTAGE SUPERVISOR AND PRECISION VOLTAGE DETECTOR

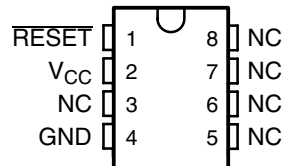
SLVS0411 – SEPTEMBER 1991 – REVISED AUGUST 2003

- Power-On Reset Generator
- Automatic Reset Generation After Voltage Drop
- Low Standby Current . . . 20  $\mu$ A
- RESET Output Defined When  $V_{CC}$  Exceeds 1 V
- Precision Threshold Voltage 4.55 V  $\pm$ 120 mV
- High Output Sink Capability . . . 20 mA
- Comparator Hysteresis Prevents Erratic Resets

## description/ordering information

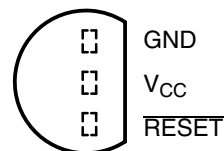
The TL7757 is a supply-voltage supervisor designed for use in microcomputer and microprocessor systems. The supervisor monitors the supply voltage for undervoltage conditions. During power up, when the supply voltage,  $V_{CC}$ , attains a value approaching 1 V, the RESET output becomes active (low) to prevent undefined operation. If the supply voltage drops below threshold voltage level ( $V_{IT-}$ ), the RESET output goes to the active (low) level until the supply undervoltage fault condition is eliminated.

**D PACKAGE  
(TOP VIEW)**

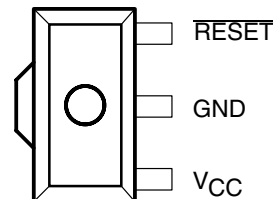


NC—No internal connection

**LP PACKAGE  
(TOP VIEW)**



**PK PACKAGE  
(TOP VIEW)**



GND is in electrical contact with the tab.

## ORDERING INFORMATION

| $T_A$         | PACKAGE†   |                    | ORDERABLE PART NUMBER | TOP-SIDE MARKING |
|---------------|------------|--------------------|-----------------------|------------------|
| 0°C to 70°C   | SOIC (D)   | Tube of 75         | TL7757CD              | 7757C            |
|               |            | Reel of 2500       | TL7757CDR             |                  |
|               | SOT (PK)   | Reel of 1000       | TL7757CPK             | T7               |
|               |            | TO226 / TO-92 (LP) | Bulk of 1000          | TL7757CLP        |
| Reel of 2000  | TL7757CLPR |                    |                       |                  |
| -40°C to 85°C | SOIC (D)   | Tube of 75         | TL7757ID              | 7757I            |
|               |            | Reel of 2500       | TL7757IDR             |                  |
|               | SOT (PK)   | Reel of 1000       | TL7757IPK             | 7I               |
|               |            | TO226 / TO-92 (LP) | Bulk of 1000          | TL7757ILP        |
| Reel of 2000  | TL7757ILPR |                    |                       |                  |

† Package drawings, standard packing quantities, thermal data, symbolization, and PCB design guidelines are available at [www.ti.com/sc/package](http://www.ti.com/sc/package).



Please be aware that an important notice concerning availability, standard warranty, and use in critical applications of Texas Instruments semiconductor products and disclaimers thereto appears at the end of this data sheet.

PRODUCTION DATA information is current as of publication date. Products conform to specifications per the terms of Texas Instruments standard warranty. Production processing does not necessarily include testing of all parameters.

**TEXAS  
INSTRUMENTS**

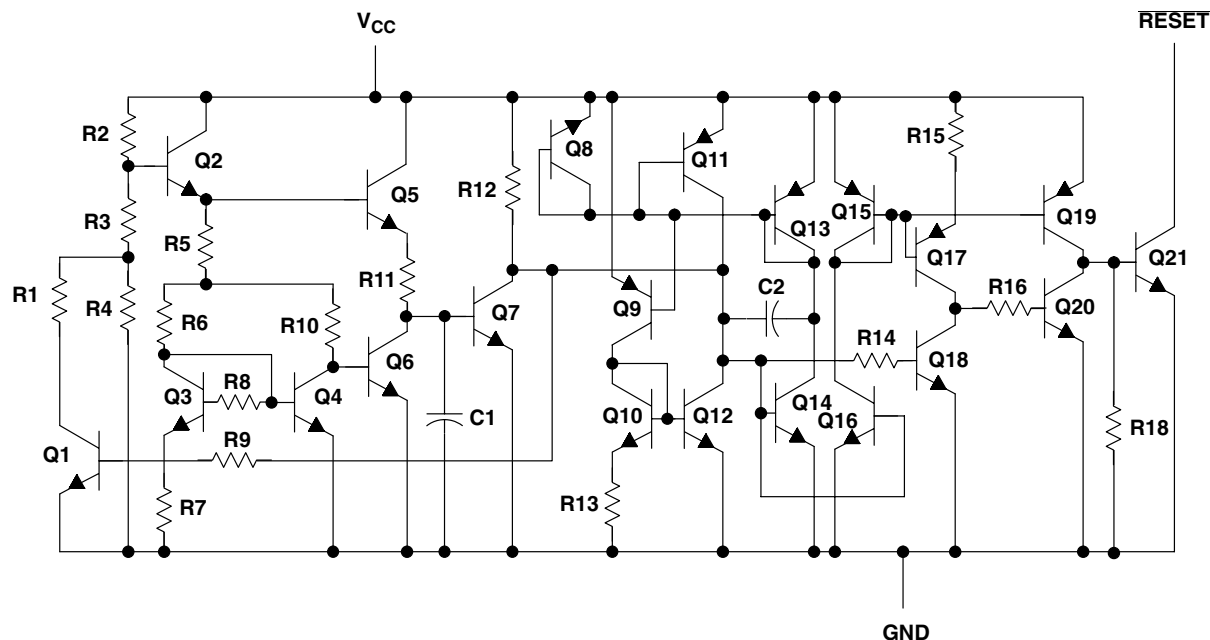
POST OFFICE BOX 655303 • DALLAS, TEXAS 75265

Copyright © 2003, Texas Instruments Incorporated

# TL7757 SUPPLY-VOLTAGE SUPERVISOR AND PRECISION VOLTAGE DETECTOR

SLVS0411 – SEPTEMBER 1991 – REVISED AUGUST 2003

## equivalent schematic



| ACTUAL DEVICE COMPONENT COUNT |    |
|-------------------------------|----|
| Transistors                   | 27 |
| Resistors                     | 20 |
| Capacitors                    | 2  |

## absolute maximum ratings over operating junction temperature range (unless otherwise noted)†

|   |                |
|---|----------------|
| Supply voltage range, $V_{CC}$ (see Note 1)                   | -0.3 V to 20 V |
| Off-state output voltage range (see Note 1)                   | -0.3 V to 20 V |
| Output current, $I_O$   | 30 mA          |
| Package thermal impedance, $\theta_{JA}$ (see Notes 2 and 3): |                |
| D package   | 97°C/W         |
| LP package  | 140°C/W        |
| PK package  | 52°C/W         |
| Operating virtual junction temperature, $T_J$                 | 150°C          |
| Lead temperature 1,6 mm (1/16 inch) from case for 10 seconds  | 260°C          |
| Storage temperature range, $T_{stg}$                          | -65°C to 150°C |

† Stresses beyond those listed under “absolute maximum ratings” may cause permanent damage to the device. These are stress ratings only, and functional operation of the device at these or any other conditions beyond those indicated under “recommended operating conditions” is not implied. Exposure to absolute-maximum-rated conditions for extended periods may affect device reliability.

- NOTES:
1. All voltage values are with respect to network terminal ground.
  2. Maximum power dissipation is a function of  $T_J(\max)$ ,  $\theta_{JA}$ , and  $T_A$ . The maximum allowable power dissipation at any allowable ambient temperature is  $P_D = (T_J(\max) - T_A) / \theta_{JA}$ . Operating at the absolute maximum  $T_J$  of 150°C can affect reliability.
  3. The package thermal impedance is calculated in accordance with JESD 51-7.

**TL7757**  
**SUPPLY-VOLTAGE SUPERVISOR**  
**AND PRECISION VOLTAGE DETECTOR**

SLVS0411 – SEPTEMBER 1991 – REVISED AUGUST 2003

**recommended operating conditions**

|          |                                | MIN     | MAX | UNIT |    |
|----------|--------------------------------|---------|-----|------|----|
| $V_{CC}$ | Supply voltage                 | 1       | 7   | V    |    |
| $V_{OH}$ | High-level output voltage      |         | 15  | V    |    |
| $I_{OL}$ | Low-level output current       |         | 20  | mA   |    |
| $T_A$    | Operating free-air temperature | TL7757C | 0   | 70   | °C |
|          |                                | TL7757I | -40 | 85   |    |

**electrical characteristics at specified free-air temperature**

| PARAMETER          | TEST CONDITIONS   | $T_A$            | TL7757C     |      |      | UNIT |
|--------------------|---|------------------|-------------|------|------|------|
|                    |   |                  | MIN         | TYP  | MAX  |      |
| $V_{IT-}$          | Negative-going input threshold voltage at $V_{CC}$                            | 25°C             | 4.43        | 4.55 | 4.67 | V    |
|                    |   | 0°C to 70°C      | 4.4         |      | 4.7  |      |
| $V_{hys}^\dagger$  | Hysteresis at $V_{CC}$  | 25°C             | 40          | 50   | 60   | mV   |
|                    |   | 0°C to 70°C      | 30          |      | 70   |      |
| $V_{OL}$           | Low-level output voltage<br>$I_{OL} = 20$ mA, $V_{CC} = 4.3$ V                | 25°C             |             | 0.4  | 0.8  | V    |
|                    |   | 0°C to 70°C      |             |      | 0.8  |      |
| $I_{OH}$           | High-level output current<br>$V_{CC} = 7$ V, $V_{OH} = 15$ V,<br>See Figure 1 | 25°C             |             |      | 1    | μA   |
|                    |   | 0°C to 70°C      |             |      | 1    |      |
| $V_{res}^\ddagger$ | Power-up reset voltage<br>$R_L = 2.2$ kΩ,<br>$V_{CC}$ slew rate $\leq 5$ V/μs | 25°C             |             | 0.8  | 1    | V    |
|                    |   | 0°C to 70°C      |             |      | 1.2  |      |
| $I_{CC}$           | Supply current<br>$V_{CC} = 4.3$ V  | 25°C             |             | 1400 | 2000 | μA   |
|                    |   | 0°C to 70°C      |             |      | 2000 |      |
|                    |   | $V_{CC} = 5.5$ V | 0°C to 70°C |      |      |      |

$^\dagger$  This is the difference between positive-going input threshold voltage,  $V_{IT+}$ , and negative-going input threshold voltage,  $V_{IT-}$ .

$^\ddagger$  This is the lowest voltage at which RESET becomes active.

**switching characteristics at specified free-air temperature**

| PARAMETER    | TEST CONDITIONS  | $T_A$       | TL7757C |      |     | UNIT |
|--------------|--|-------------|---------|------|-----|------|
|              |  |             | MIN     | TYP  | MAX |      |
| $t_{PLH}$    | Propagation delay time, low-to-high-level output<br>$V_{CC}$ slew rate $\leq 5$ V/μs,<br>See Figures 2 and 3 | 25°C        |         | 3.4  | 5   | μs   |
|              |  | 0°C to 70°C |         |      | 5   |      |
| $t_{PHL}$    | Propagation delay time, high-to-low-level output<br>See Figures 2 and 3                                      | 25°C        |         | 2    | 5   | μs   |
|              |  | 0°C to 70°C |         |      | 5   |      |
| $t_r$        | Rise time<br>$V_{CC}$ slew rate $\leq 5$ V/μs,<br>See Figures 2 and 3  | 25°C        |         | 0.4  | 1   | μs   |
|              |  | 0°C to 70°C |         |      | 1   |      |
| $t_f$        | Fall time<br>See Figures 2 and 3   | 25°C        |         | 0.05 | 1   | μs   |
|              |  | 0°C to 70°C |         |      | 1   |      |
| $t_{w(min)}$ | Minimum pulse duration at $V_{CC}$ for output response   | 25°C        |         |      | 5   | μs   |
|              |  | 0°C to 70°C |         |      | 5   |      |



**TL7757**  
**SUPPLY-VOLTAGE SUPERVISOR**  
**AND PRECISION VOLTAGE DETECTOR**

SLVS0411 – SEPTEMBER 1991 – REVISED AUGUST 2003

**electrical characteristics at specified free-air temperature**

| PARAMETER  | TEST CONDITIONS   | T <sub>A</sub> | TL7757I |      |      | UNIT |
|--|---|----------------|---------|------|------|------|
|  |   |                | MIN     | TYP  | MAX  |      |
| V <sub>IT-</sub> Negative-going input threshold voltage at V <sub>CC</sub> |   | 25°C           | 4.43    | 4.55 | 4.67 | V    |
|  |   | -40°C to 85°C  | 4.4     |      | 4.7  |      |
| V <sub>hys</sub> <sup>†</sup> Hysteresis at V <sub>CC</sub>                |   | 25°C           | 40      | 50   | 60   | mV   |
|  |   | -40°C to 85°C  | 30      |      | 70   |      |
| V <sub>OL</sub> Low-level output voltage                                   | I <sub>OL</sub> = 20 mA, V <sub>CC</sub> = 4.3 V            | 25°C           |         | 0.4  | 0.8  | V    |
|  |   | -40°C to 85°C  |         |      | 0.8  |      |
| I <sub>OH</sub> High-level output current                                  | V <sub>CC</sub> = 7 V, V <sub>OH</sub> = 15 V, See Figure 1 | 25°C           |         |      | 1    | μA   |
|  |   | -40°C to 85°C  |         |      | 1    |      |
| V <sub>res</sub> <sup>‡</sup> Power-up reset voltage                       | R <sub>L</sub> = 2.2 kΩ, V <sub>CC</sub> slew rate ≤ 5 V/μs | 25°C           |         | 0.8  | 1    | V    |
|  |   | -40°C to 85°C  |         |      | 1.2  |      |
| I <sub>CC</sub> Supply current   | V <sub>CC</sub> = 4.3 V                                     | 25°C           |         | 1400 | 2000 | μA   |
|  |   | -40°C to 85°C  |         |      | 2100 |      |
|  |   | -40°C to 85°C  |         |      | 40   |      |

<sup>†</sup> This is the difference between positive-going input threshold voltage, V<sub>IT+</sub>, and negative-going input threshold voltage, V<sub>IT-</sub>.

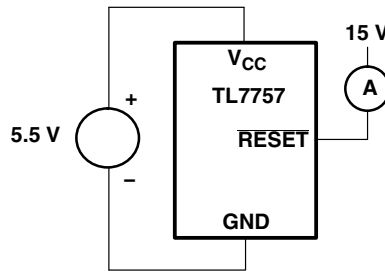
<sup>‡</sup> This is the lowest voltage at which RESET becomes active.

**switching characteristics at specified free-air temperature**

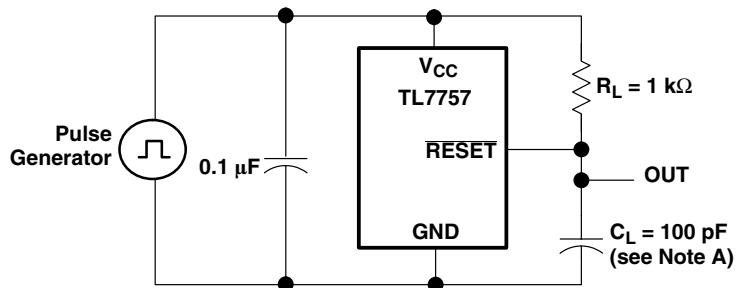
| PARAMETER   | TEST CONDITIONS   | T <sub>A</sub> | TL7757I |      |     | UNIT |
|---|---|----------------|---------|------|-----|------|
|   |   |                | MIN     | TYP  | MAX |      |
| t <sub>PLH</sub> Propagation delay time, low-to-high-level output                 | V <sub>CC</sub> slew rate ≤ 5 V/μs, See Figures 2 and 3 | 25°C           |         | 3.4  | 5   | μs   |
|   |   | -40°C to 85°C  |         |      | 5   |      |
| t <sub>PHL</sub> Propagation delay time, high-to-low-level output                 | See Figures 2 and 3                                     | 25°C           |         | 2    | 5   | μs   |
|   |   | -40°C to 85°C  |         |      | 5   |      |
| t <sub>r</sub> Rise time  | V <sub>CC</sub> slew rate ≤ 5 V/μs, See Figures 2 and 3 | 25°C           |         | 0.4  | 1   | μs   |
|   |   | -40°C to 85°C  |         |      | 1   |      |
| t <sub>f</sub> Fall time  | See Figures 2 and 3                                     | 25°C           |         | 0.05 | 1   | μs   |
|   |   | -40°C to 85°C  |         |      | 1   |      |
| t <sub>w(min)</sub> Minimum pulse duration at V <sub>CC</sub> for output response |   | 25°C           |         |      | 5   | μs   |
|   |   | -40°C to 85°C  |         |      | 5   |      |



**PARAMETER MEASUREMENT INFORMATION**

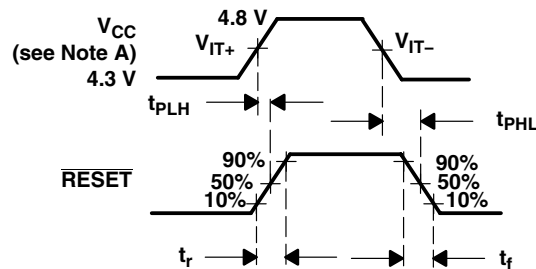


**Figure 1. Test Circuit for Output Leakage Current**



NOTE A: Includes jig and probe capacitance

**Figure 2. Test Circuit for  $\overline{\text{RESET}}$  Output Switching Characteristics**



NOTE A:  $V_{CC}$  slew rate  $\leq 5 \mu\text{s}$

**Figure 3. Switching Diagram**

**TL7757**  
**SUPPLY-VOLTAGE SUPERVISOR**  
**AND PRECISION VOLTAGE DETECTOR**

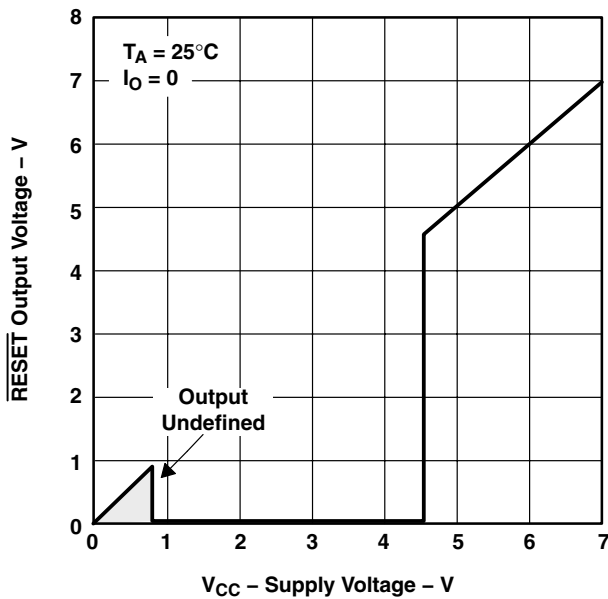
SLVS0411 – SEPTEMBER 1991 – REVISED AUGUST 2003

**TYPICAL CHARACTERISTICS†**

**Table of Graphs**

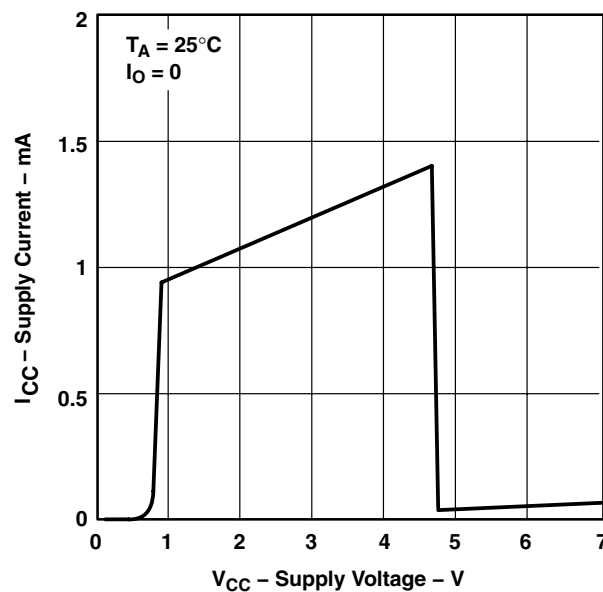
|  | FIGURE |
|--|--------|
| V <sub>CC</sub> Supply voltage vs $\overline{\text{RESET}}$ output voltage                         | 4      |
| I <sub>CC</sub> Supply current vs Supply voltage   | 5      |
| I <sub>CC</sub> Supply current vs Free-air temperature   | 6      |
| V <sub>OL</sub> Low-level output voltage vs Low-level output current                               | 7      |
| V <sub>OL</sub> Low-level output voltage vs Free-air temperature                                   | 8      |
| I <sub>OL</sub> Output current vs Supply voltage   | 9      |
| V <sub>IT-</sub> Input threshold voltage (negative-going V <sub>CC</sub> ) vs Free-air temperature | 10     |
| V <sub>res</sub> Power-up reset voltage vs Free-air temperature                                    | 11     |
| V <sub>res</sub> Power-up reset voltage and supply voltage vs Time                                 | 12     |
| Propagation delay time   | 13     |

**SUPPLY VOLTAGE  
vs  
RESET OUTPUT VOLTAGE**



**Figure 4**

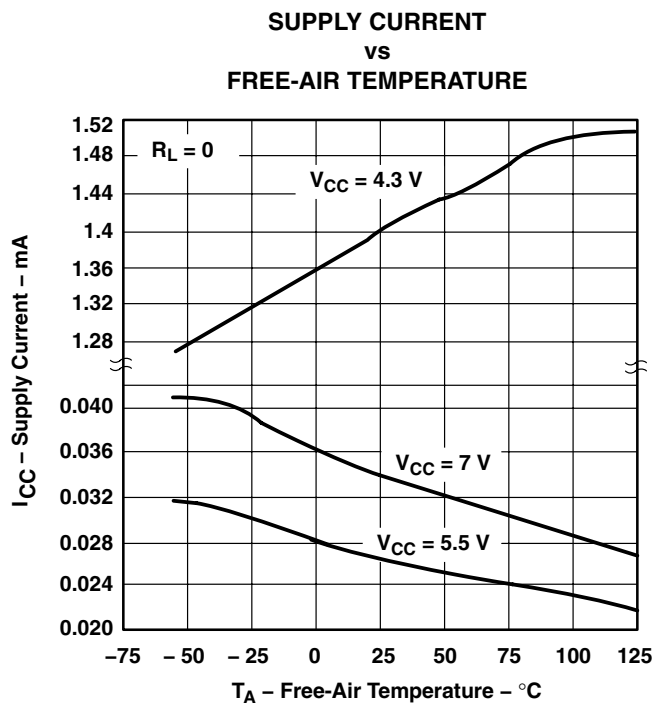
**SUPPLY CURRENT  
vs  
SUPPLY VOLTAGE**



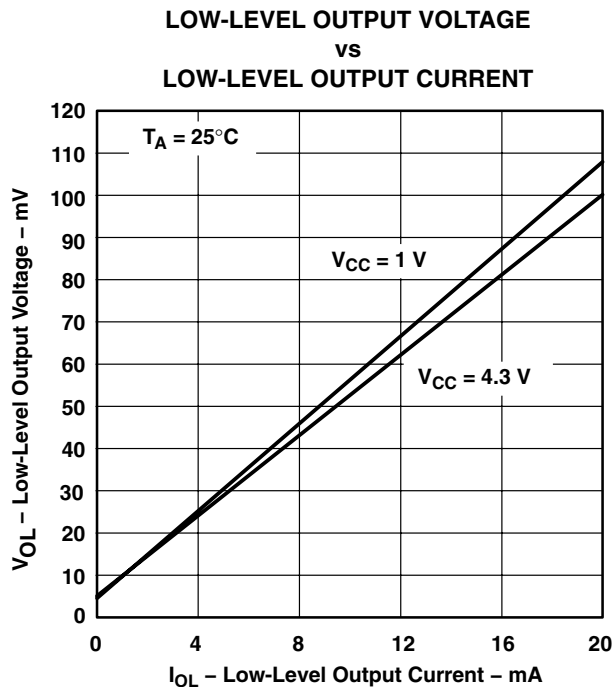
**Figure 5**

† Data at high and low temperatures are applicable only within the rated operating free-air temperature ranges of the various devices.

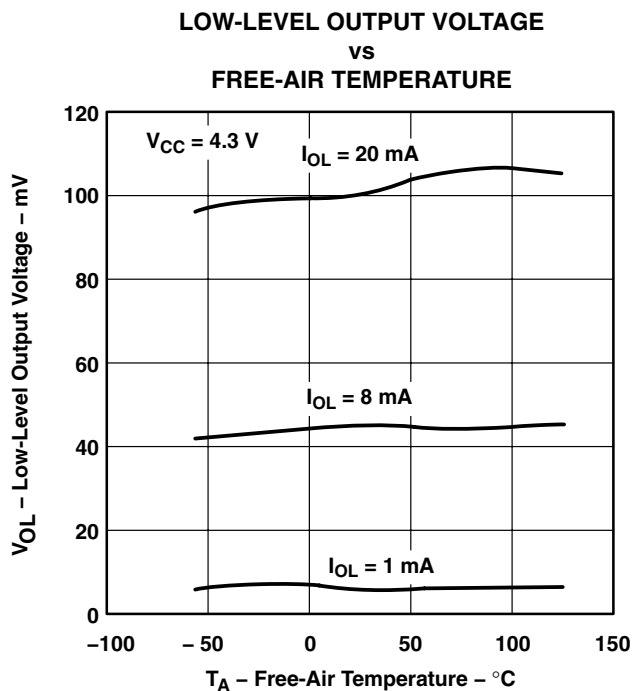
**TYPICAL CHARACTERISTICS†**



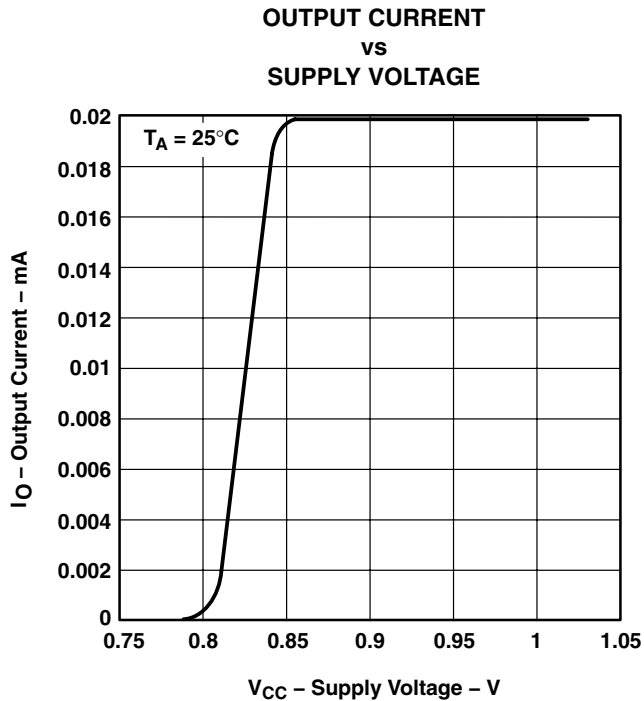
**Figure 6**



**Figure 7**



**Figure 8**



**Figure 9**

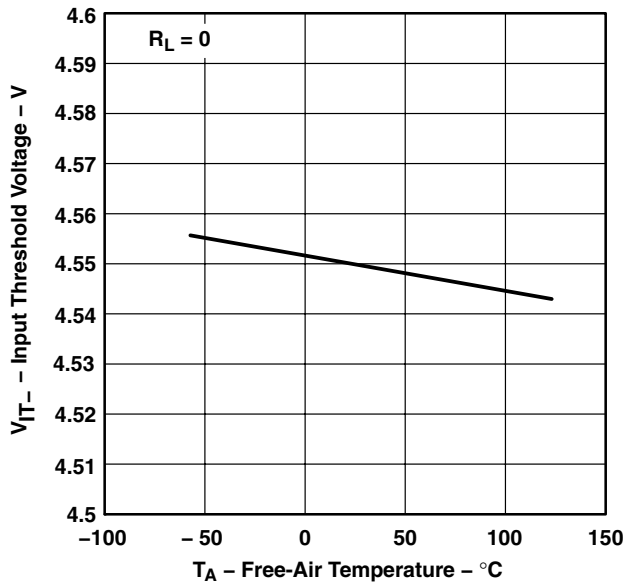
† Data at high and low temperatures are applicable only within the rated operating free-air temperature ranges of the various devices.

**TL7757**  
**SUPPLY-VOLTAGE SUPERVISOR**  
**AND PRECISION VOLTAGE DETECTOR**

SLVS0411 – SEPTEMBER 1991 – REVISED AUGUST 2003

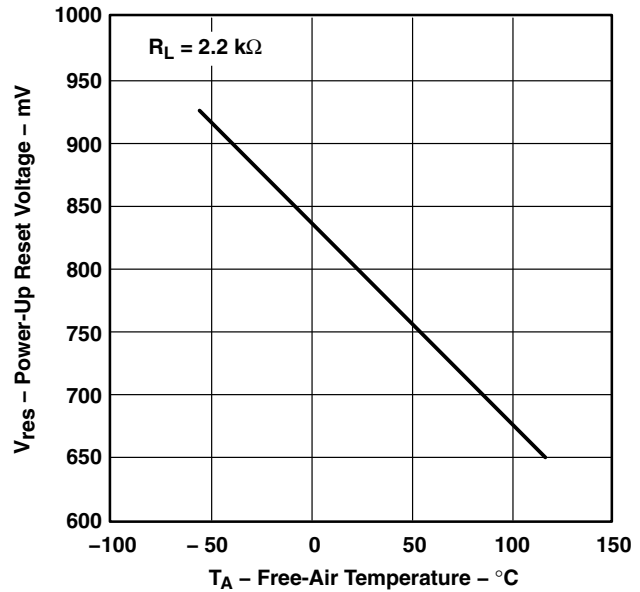
**TYPICAL CHARACTERISTICS†**

**INPUT THRESHOLD VOLTAGE  
 (NEGATIVE-GOING  $V_{CC}$ )  
 vs  
 FREE-AIR TEMPERATURE**



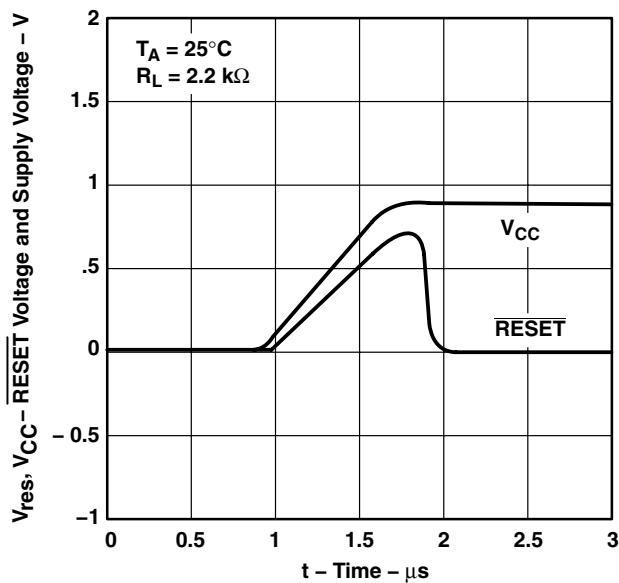
**Figure 10**

**POWER-UP RESET VOLTAGE  
 vs  
 FREE-AIR TEMPERATURE**



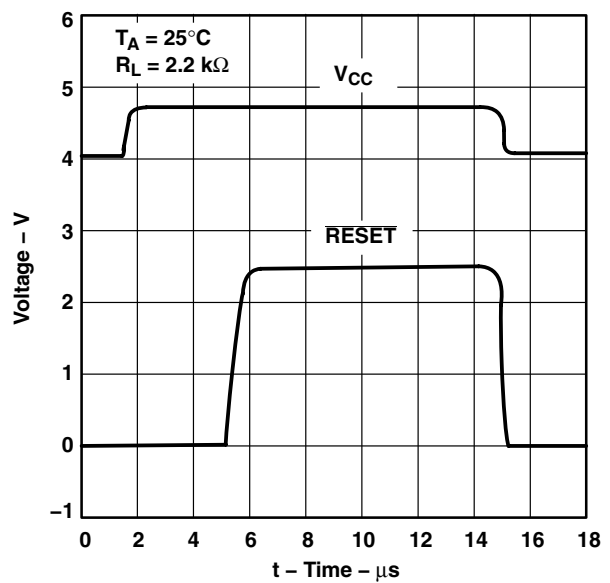
**Figure 11**

**POWER-UP RESET VOLTAGE  
 AND SUPPLY VOLTAGE  
 vs  
 TIME**



**Figure 12**

**PROPAGATION DELAY TIME**



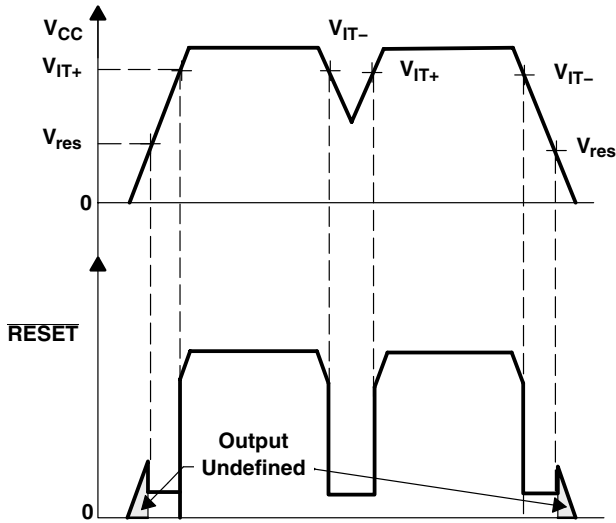
**Figure 13**

† Data at high and low temperatures are applicable only within the rated operating free-air temperature ranges of the various devices.

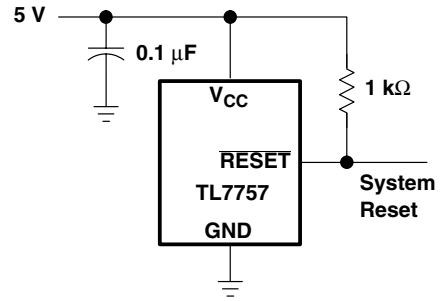


**APPLICATION INFORMATION**

**TYPICAL TIMING DIAGRAM**



**TYPICAL APPLICATION DIAGRAM**



**PACKAGING INFORMATION**

| Orderable Device | Status<br>(1) | Package Type | Package Drawing | Pins | Package Qty | Eco Plan<br>(2) | Lead finish/<br>Ball material<br>(6) | MSL Peak Temp<br>(3) | Op Temp (°C) | Device Marking<br>(4/5) | Samples                 |
|------------------|---------------|--------------|-----------------|------|-------------|-----------------|--------------------------------------|----------------------|--------------|-------------------------|-------------------------|
| TL7757CD         | ACTIVE        | SOIC         | D               | 8    | 75          | RoHS & Green    | NIPDAU                               | Level-1-260C-UNLIM   | 0 to 70      | 7757C                   | <a href="#">Samples</a> |
| TL7757CDE4       | ACTIVE        | SOIC         | D               | 8    | 75          | RoHS & Green    | NIPDAU                               | Level-1-260C-UNLIM   | 0 to 70      | 7757C                   | <a href="#">Samples</a> |
| TL7757CDR        | ACTIVE        | SOIC         | D               | 8    | 2500        | RoHS & Green    | NIPDAU                               | Level-1-260C-UNLIM   | 0 to 70      | 7757C                   | <a href="#">Samples</a> |
| TL7757CLP        | ACTIVE        | TO-92        | LP              | 3    | 1000        | RoHS & Green    | SN                                   | N / A for Pkg Type   | 0 to 70      | TL7757C                 | <a href="#">Samples</a> |
| TL7757CLPE3      | ACTIVE        | TO-92        | LP              | 3    | 1000        | RoHS & Green    | SN                                   | N / A for Pkg Type   | 0 to 70      | TL7757C                 | <a href="#">Samples</a> |
| TL7757CLPR       | ACTIVE        | TO-92        | LP              | 3    | 2000        | RoHS & Green    | SN                                   | N / A for Pkg Type   | 0 to 70      | TL7757C                 | <a href="#">Samples</a> |
| TL7757CPK        | ACTIVE        | SOT-89       | PK              | 3    | 1000        | RoHS & Green    | SN                                   | Level-2-260C-1 YEAR  | 0 to 70      | T 7                     | <a href="#">Samples</a> |
| TL7757ID         | ACTIVE        | SOIC         | D               | 8    | 75          | RoHS & Green    | NIPDAU                               | Level-1-260C-UNLIM   | -40 to 85    | 7757I                   | <a href="#">Samples</a> |
| TL7757IDR        | ACTIVE        | SOIC         | D               | 8    | 2500        | RoHS & Green    | NIPDAU                               | Level-1-260C-UNLIM   | -40 to 85    | 7757I                   | <a href="#">Samples</a> |
| TL7757ILP        | ACTIVE        | TO-92        | LP              | 3    | 1000        | RoHS & Green    | SN                                   | N / A for Pkg Type   | -40 to 85    | TL7757I                 | <a href="#">Samples</a> |
| TL7757ILPE3      | ACTIVE        | TO-92        | LP              | 3    | 1000        | RoHS & Green    | SN                                   | N / A for Pkg Type   | -40 to 85    | TL7757I                 | <a href="#">Samples</a> |
| TL7757ILPR       | ACTIVE        | TO-92        | LP              | 3    | 2000        | RoHS & Green    | SN                                   | N / A for Pkg Type   | -40 to 85    | TL7757I                 | <a href="#">Samples</a> |
| TL7757IPK        | ACTIVE        | SOT-89       | PK              | 3    | 1000        | RoHS & Green    | SN                                   | Level-2-260C-1 YEAR  | -40 to 85    | 7I                      | <a href="#">Samples</a> |
| TL7757IPKG3      | ACTIVE        | SOT-89       | PK              | 3    | 1000        | RoHS & Green    | SN                                   | Level-2-260C-1 YEAR  | -40 to 85    | 7I                      | <a href="#">Samples</a> |

(1) The marketing status values are defined as follows:

**ACTIVE:** Product device recommended for new designs.

**LIFEBUY:** TI has announced that the device will be discontinued, and a lifetime-buy period is in effect.

**NRND:** Not recommended for new designs. Device is in production to support existing customers, but TI does not recommend using this part in a new design.

**PREVIEW:** Device has been announced but is not in production. Samples may or may not be available.

**OBSOLETE:** TI has discontinued the production of the device.

(2) **RoHS:** TI defines "RoHS" to mean semiconductor products that are compliant with the current EU RoHS requirements for all 10 RoHS substances, including the requirement that RoHS substance do not exceed 0.1% by weight in homogeneous materials. Where designed to be soldered at high temperatures, "RoHS" products are suitable for use in specified lead-free processes. TI may reference these types of products as "Pb-Free".

**RoHS Exempt:** TI defines "RoHS Exempt" to mean products that contain lead but are compliant with EU RoHS pursuant to a specific EU RoHS exemption.

**Green:** TI defines "Green" to mean the content of Chlorine (Cl) and Bromine (Br) based flame retardants meet JS709B low halogen requirements of  $\leq 1000$ ppm threshold. Antimony trioxide based flame retardants must also meet the  $\leq 1000$ ppm threshold requirement.

(3) MSL, Peak Temp. - The Moisture Sensitivity Level rating according to the JEDEC industry standard classifications, and peak solder temperature.

(4) There may be additional marking, which relates to the logo, the lot trace code information, or the environmental category on the device.

(5) Multiple Device Markings will be inside parentheses. Only one Device Marking contained in parentheses and separated by a "~" will appear on a device. If a line is indented then it is a continuation of the previous line and the two combined represent the entire Device Marking for that device.

(6) Lead finish/Ball material - Orderable Devices may have multiple material finish options. Finish options are separated by a vertical ruled line. Lead finish/Ball material values may wrap to two lines if the finish value exceeds the maximum column width.

**Important Information and Disclaimer:** The information provided on this page represents TI's knowledge and belief as of the date that it is provided. TI bases its knowledge and belief on information provided by third parties, and makes no representation or warranty as to the accuracy of such information. Efforts are underway to better integrate information from third parties. TI has taken and continues to take reasonable steps to provide representative and accurate information but may not have conducted destructive testing or chemical analysis on incoming materials and chemicals. TI and TI suppliers consider certain information to be proprietary, and thus CAS numbers and other limited information may not be available for release.

In no event shall TI's liability arising out of such information exceed the total purchase price of the TI part(s) at issue in this document sold by TI to Customer on an annual basis.

**TAPE AND REEL INFORMATION**

**QUADRANT ASSIGNMENTS FOR PIN 1 ORIENTATION IN TAPE**


\*All dimensions are nominal

| Device    | Package Type | Package Drawing | Pins | SPQ  | Reel Diameter (mm) | Reel Width W1 (mm) | A0 (mm) | B0 (mm) | K0 (mm) | P1 (mm) | W (mm) | Pin1 Quadrant |
|-----------|--------------|-----------------|------|------|--------------------|--------------------|---------|---------|---------|---------|--------|---------------|
| TL7757CDR | SOIC         | D               | 8    | 2500 | 330.0              | 12.4               | 6.4     | 5.2     | 2.1     | 8.0     | 12.0   | Q1            |
| TL7757CPK | SOT-89       | PK              | 3    | 1000 | 180.0              | 12.4               | 4.91    | 4.52    | 1.9     | 8.0     | 12.0   | Q3            |
| TL7757IDR | SOIC         | D               | 8    | 2500 | 330.0              | 12.4               | 6.4     | 5.2     | 2.1     | 8.0     | 12.0   | Q1            |
| TL7757IPK | SOT-89       | PK              | 3    | 1000 | 180.0              | 12.4               | 4.91    | 4.52    | 1.9     | 8.0     | 12.0   | Q3            |

**TAPE AND REEL BOX DIMENSIONS**


\*All dimensions are nominal

| Device    | Package Type | Package Drawing | Pins | SPQ  | Length (mm) | Width (mm) | Height (mm) |
|-----------|--------------|-----------------|------|------|-------------|------------|-------------|
| TL7757CDR | SOIC         | D               | 8    | 2500 | 340.5       | 336.1      | 25.0        |
| TL7757CPK | SOT-89       | PK              | 3    | 1000 | 340.0       | 340.0      | 38.0        |
| TL7757IDR | SOIC         | D               | 8    | 2500 | 340.5       | 336.1      | 25.0        |
| TL7757IPK | SOT-89       | PK              | 3    | 1000 | 340.0       | 340.0      | 38.0        |

**TUBE**


\*All dimensions are nominal

| Device     | Package Name | Package Type | Pins | SPQ | L (mm) | W (mm) | T (μm) | B (mm) |
|------------|--------------|--------------|------|-----|--------|--------|--------|--------|
| TL7757CD   | D            | SOIC         | 8    | 75  | 507    | 8      | 3940   | 4.32   |
| TL7757CDE4 | D            | SOIC         | 8    | 75  | 507    | 8      | 3940   | 4.32   |
| TL7757ID   | D            | SOIC         | 8    | 75  | 507    | 8      | 3940   | 4.32   |

PK (R-PSS0-F3)

PLASTIC SINGLE-IN-LINE PACKAGE



- NOTES:
- All linear dimensions are in millimeters. Dimensioning and tolerancing per ASME Y14.5M-1994.
  - This drawing is subject to change without notice.
  - The center lead is in electrical contact with the tab.
  - Body dimensions do not include mold flash or protrusion. Mold flash and protrusion not to exceed 0.15 per side.
- ⚠ Thermal pad contour optional within these dimensions.
- ⚠ Falls within JEDEC TO-243 variation AA, except minimum lead length, pin 2 minimum lead width, minimum tab width.

PK (R-PDSO-G3)



- NOTES:
- A. All linear dimensions are in millimeters.
  - B. This drawing is subject to change without notice.
  - C. Publication IPC-7351 is recommended for alternate designs.
  - D. Laser cutting apertures with trapezoidal walls and also rounding corners will offer better paste release. Customers should contact their board assembly site for stencil design recommendations. Refer to IPC-7525.
  - E. Customers should contact their board fabrication site for solder mask tolerances between and around signal pads.





D0008A

# PACKAGE OUTLINE

SOIC - 1.75 mm max height

SMALL OUTLINE INTEGRATED CIRCUIT



4214825/C 02/2019

### NOTES:

1. Linear dimensions are in inches [millimeters]. Dimensions in parenthesis are for reference only. Controlling dimensions are in inches. Dimensioning and tolerancing per ASME Y14.5M.
2. This drawing is subject to change without notice.
3. This dimension does not include mold flash, protrusions, or gate burrs. Mold flash, protrusions, or gate burrs shall not exceed  $.006$  [0.15] per side.
4. This dimension does not include interlead flash.
5. Reference JEDEC registration MS-012, variation AA.

# EXAMPLE BOARD LAYOUT

D0008A

SOIC - 1.75 mm max height

SMALL OUTLINE INTEGRATED CIRCUIT



LAND PATTERN EXAMPLE  
 EXPOSED METAL SHOWN  
 SCALE:8X



SOLDER MASK DETAILS

4214825/C 02/2019

NOTES: (continued)

- 6. Publication IPC-7351 may have alternate designs.
- 7. Solder mask tolerances between and around signal pads can vary based on board fabrication site.

# EXAMPLE STENCIL DESIGN

D0008A

SOIC - 1.75 mm max height

SMALL OUTLINE INTEGRATED CIRCUIT



SOLDER PASTE EXAMPLE  
BASED ON .005 INCH [0.125 MM] THICK STENCIL  
SCALE:8X

4214825/C 02/2019

NOTES: (continued)

8. Laser cutting apertures with trapezoidal walls and rounded corners may offer better paste release. IPC-7525 may have alternate design recommendations.
9. Board assembly site may have different recommendations for stencil design.

## GENERIC PACKAGE VIEW

LP 3

TO-92 - 5.34 mm max height

TRANSISTOR OUTLINE



Images above are just a representation of the package family, actual package may vary.  
Refer to the product data sheet for package details.

4040001-2/F

LP0003A



PACKAGE OUTLINE

TO-92 - 5.34 mm max height

TO-92



4215214/B 04/2017

NOTES:

1. All linear dimensions are in millimeters. Any dimensions in parenthesis are for reference only. Dimensioning and tolerancing per ASME Y14.5M.
2. This drawing is subject to change without notice.
3. Lead dimensions are not controlled within this area.
4. Reference JEDEC TO-226, variation AA.
5. Shipping method:
  - a. Straight lead option available in bulk pack only.
  - b. Formed lead option available in tape and reel or ammo pack.
  - c. Specific products can be offered in limited combinations of shipping medium and lead options.
  - d. Consult product folder for more information on available options.



LAND PATTERN EXAMPLE  
STRAIGHT LEAD OPTION  
NON-SOLDER MASK DEFINED  
SCALE:15X



LAND PATTERN EXAMPLE  
FORMED LEAD OPTION  
NON-SOLDER MASK DEFINED  
SCALE:15X

# TAPE SPECIFICATIONS

LP0003A

TO-92 - 5.34 mm max height

TO-92



FOR FORMED LEAD OPTION PACKAGE

4215214/B 04/2017

## IMPORTANT NOTICE AND DISCLAIMER

TI PROVIDES TECHNICAL AND RELIABILITY DATA (INCLUDING DATA SHEETS), DESIGN RESOURCES (INCLUDING REFERENCE DESIGNS), APPLICATION OR OTHER DESIGN ADVICE, WEB TOOLS, SAFETY INFORMATION, AND OTHER RESOURCES "AS IS" AND WITH ALL FAULTS, AND DISCLAIMS ALL WARRANTIES, EXPRESS AND IMPLIED, INCLUDING WITHOUT LIMITATION ANY IMPLIED WARRANTIES OF MERCHANTABILITY, FITNESS FOR A PARTICULAR PURPOSE OR NON-INFRINGEMENT OF THIRD PARTY INTELLECTUAL PROPERTY RIGHTS.

These resources are intended for skilled developers designing with TI products. You are solely responsible for (1) selecting the appropriate TI products for your application, (2) designing, validating and testing your application, and (3) ensuring your application meets applicable standards, and any other safety, security, regulatory or other requirements.

These resources are subject to change without notice. TI grants you permission to use these resources only for development of an application that uses the TI products described in the resource. Other reproduction and display of these resources is prohibited. No license is granted to any other TI intellectual property right or to any third party intellectual property right. TI disclaims responsibility for, and you will fully indemnify TI and its representatives against, any claims, damages, costs, losses, and liabilities arising out of your use of these resources.

TI's products are provided subject to [TI's Terms of Sale](#) or other applicable terms available either on [ti.com](http://ti.com) or provided in conjunction with such TI products. TI's provision of these resources does not expand or otherwise alter TI's applicable warranties or warranty disclaimers for TI products.

TI objects to and rejects any additional or different terms you may have proposed.

Mailing Address: Texas Instruments, Post Office Box 655303, Dallas, Texas 75265  
Copyright © 2022, Texas Instruments Incorporated