

TI Precision Designs: Verified Design

Precision Full-Wave Rectifier, Dual-Supply



TI Precision Designs

TI Precision Designs are analog solutions created by TI's analog experts. Verified Designs offer the theory, component selection, simulation, complete PCB schematic & layout, bill of materials, and measured performance of useful circuits. Circuit modifications that help to meet alternate design goals are also discussed.

Design Resources

[Design Archive](#)
[TINA-TI™](#)
[OPA2211](#)

All Design files
 SPICE Simulator
 Product Folder

Circuit Description

This dual-supply precision full-wave rectifier can turn alternating current (ac) signals to single polarity signals. The op amps, U_{1A} and U_{1B} , buffer the input signal and compensate for the voltage drops across D_1 and D_2 allowing for small signal inputs. This implementation functions with limited distortion for 20 Vpp input signals at frequencies up to 50 kHz and for signals as small as 50 mVpp at frequencies up to 1 kHz. The circuit can be used in applications that need to quantify the absolute value of input signals which have both positive and negative polarities.



[Ask The Analog Experts](#)
[WEBENCH® Design Center](#)
[TI Precision Designs Library](#)

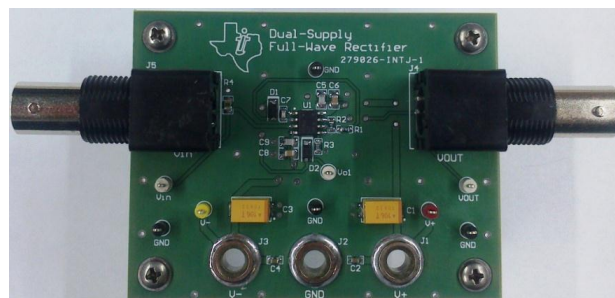
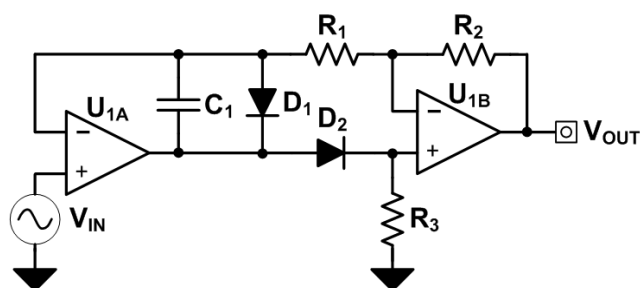

An IMPORTANT NOTICE at the end of this TI reference design addresses authorized use, intellectual property matters and other important disclaimers and information.

TINA-TI is a trademark of Texas Instruments
 WEBENCH is a registered trademark of Texas Instruments

1 Design Summary

The design requirements are as follows:

- Supply Voltage: +/-15 V
- Input: +/- 50 mV to +/- 10 V
- Output: 50 mV to 10 V Full-Wave Rectified Output

The main goal of this design was to optimize the transient performance of the circuit with a 20 Vpp input signal such that the output distortion near the transition regions was minimal. The results in Figure 1 show minimal distortion on the output (CH3) with a 10 kHz full-scale 20 Vpp input signal. Maintaining low distortion for large input signals is possible up to frequencies near 50 kHz. Rectification is possible for input amplitudes down to 50 mVpp but is only possible at input frequencies less than 1 kHz.

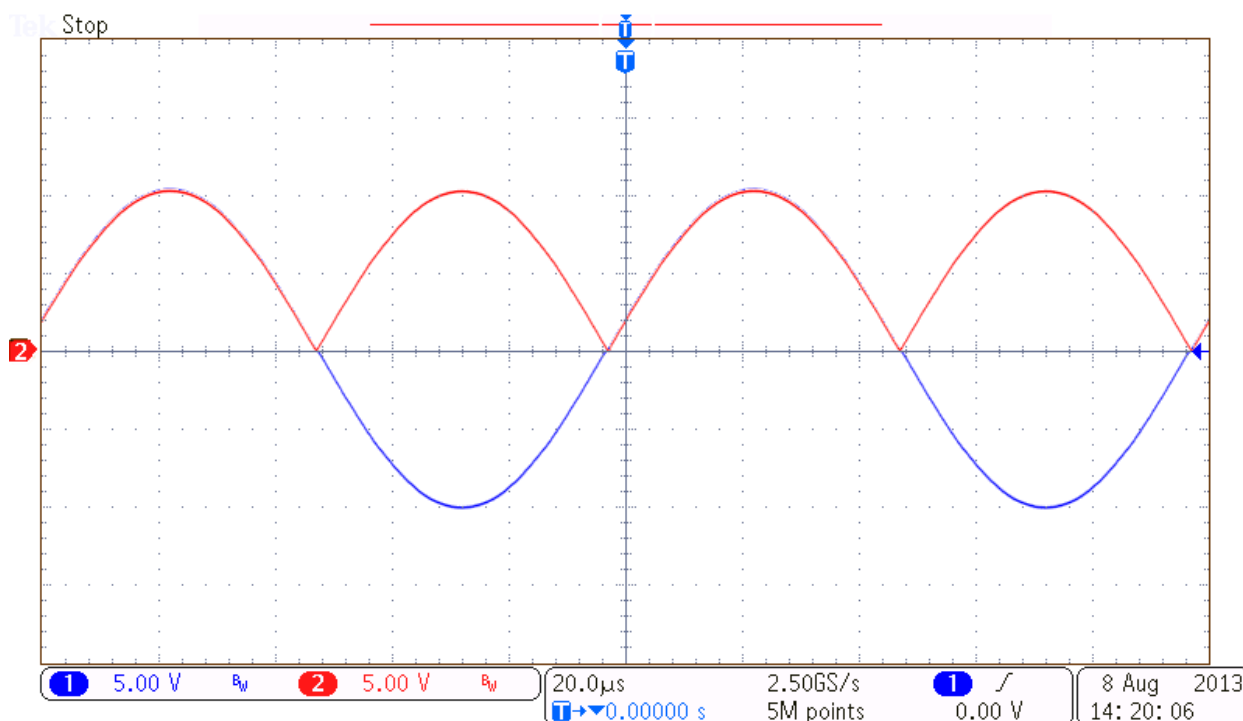

Figure 1: Measured input (CH1) and output (CH3) transient waveform at input 1 kHz with 20 Vpp Sine-wave

2 Theory of Operation

The schematic for the dual-supply rectifier is shown in Figure 1. This topology was chosen over other full-wave rectifier topologies for its simplicity while achieving the desired performance. U_{1A} and U_{1B} control the biasing of D_1 and D_2 to change the signal path based on the polarity of the input signal achieving the full-wave rectification. The input impedance of the circuit is set by the termination resistor R_4 and can be set to match the source impedance or as high as the input impedance of the U_{1A} amplifier.

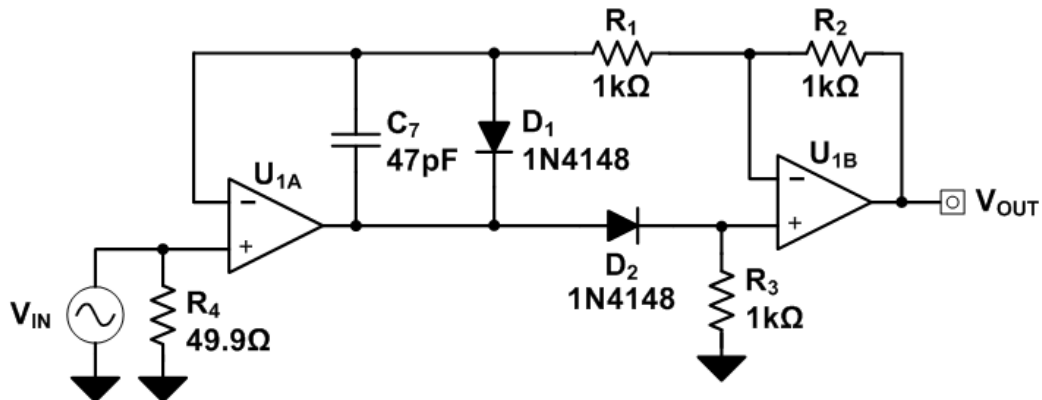

Figure 2: Circuit schematic

2.1 Simplified Circuit for Positive Input Signals

The circuit schematic and transfer function for positive input signals are shown in Figure 3 and Equation (1). Positive input signals reverse-bias D_1 and forward-bias D_2 making the components act like an open circuit and short circuit respectively. In this configuration, the U_{1A} amplifier drives the non-inverting input of U_{1B} such the voltage at the inverting input of U_{1A} that is equal to V_{IN} . Because current doesn't flow into the high-impedance inverting input of U_{1A} , there is no current through R_1 or R_2 and U_{1B} acts as a buffer. U_{1A} must therefore also act as a buffer and V_{OUT} is simply equal to V_{IN} .

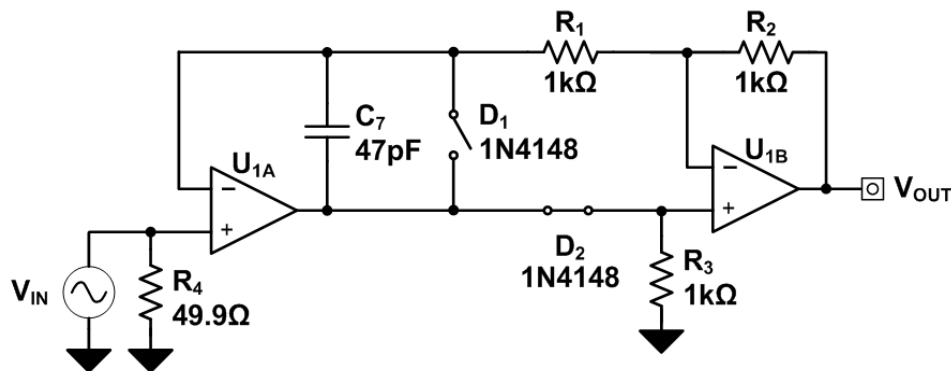

Figure 3: Simplified circuit for positive input signals

$$V_{OUT} = V_{IN}$$

(1)

2.2 Simplified Circuit for Negative Input Signals

The circuit and transfer function for negative inputs are shown in Figure 4 and Equation (2). Negative input signals forward bias D_1 and reverse bias D_2 . Therefore, U_{1A} drives U_{1B} like a standard inverting amplifier while R_3 biases the non-inverting node of U_{1B} to GND. In this configuration, the output will now be positive for negative input signals achieving the full-wave rectification.

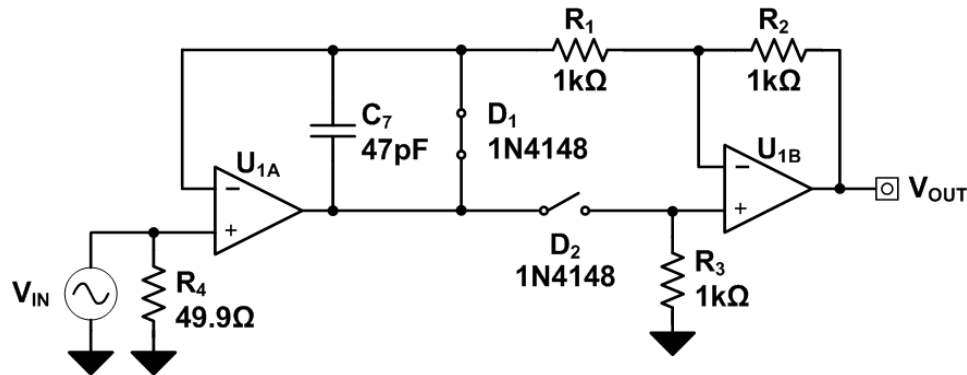

Figure 4: Simplified circuit for negative input signals

$$\frac{V_{OUT}}{V_{IN}} = \left(-\frac{R_2}{R_1}\right)$$

$$\frac{V_{OUT}}{V_{IN}} = -1V/V \quad (2)$$

2.3 Frequency Compensation

Compensation capacitor, C_7 , is added to provide a local high-frequency feedback path for U_{1A} which will help stabilize the output. The compensation capacitor should have a value that results in an equivalent impedance less than $100\ \Omega$ within the gain-bandwidth of the amplifier. Selecting too large of a capacitor will cause large distortion on the transition edges when the input signal changes polarity. C_7 was experimentally selected to be 47pF based on the desired transient performance.

3 Component Selection

3.1 Operational Amplifier

Since integrity of transient waveforms is the primary concern in this circuit, parameters such as **low noise**, **low total-harmonic-distortion (THD)**, **wide bandwidths**, **high slew rate**, **high open-loop gain (A_{OL})** are key specifications for choosing operational amplifiers (op amp). Rail-to-rail inputs (RRI) and rail-to-rail outputs (RRO) are advantageous by increasing the dynamic range.

The OPA2211 is a low-noise precision bipolar input op amp making it an excellent choice for a high performance version of this circuit. The OPA2211 features 1.1 nV/√Hz broadband noise and 0.00015% THD at 1 kHz, output slew rate of 27 V/μs, 45 MHz unity-gain bandwidth, and 130 dB of open-loop gain. Other amplifier options for this application include the OPA1611, OPA1612, or OPA827 as further discussed in Section 7.

3.2 Diode

Careful diode selection for D_1 and D_2 is required to meet the frequency and linearity design goals. Important specifications of the diodes are low forward voltage (VF), fast switching speed (TT), low diode capacitance (CD), and low leakage current (IR). Schottky diodes usually have faster transition times and lower forward voltages but larger reverse leakage currents. In general, standard diodes have lower reverse current but slower speed. The diode used in this design is a fast switching diode, 1N4148, based on its performance and cost. Table 1 compares several diode candidates.

Table 1: Diode Selection Parameters

	1N4148	BAT42W	BAS70
VF	720mV at IF=5mA	400mV at IF=10mA	410mV at IF=1mA
TT	4ns(max)	5ns(max)	5ns(max)
CD	4pF(max) at 1MHz, VR=0V	7pF(typ) at 1MHz, VR=1V	2pF(max) at 1MHz, VR=0V
IR	25nA at VR=20V	500nA at VR=25V	100nA at VR=50V

3.3 Passive Component

The most crucial passive components to keep output voltage being precisely equal to V_{IN} are the resistors, R_1 and R_2 , which set the gain. The resistors were selected to be 0.1% tolerance to achieve good gain accuracy. R_1 and R_2 were selected to be 1 kΩ to reduce thermal noise and prevent the leakage current of the diodes from causing noticeable voltage drops across the resistors.

The compensation capacitor, C_7 , was selected for proper voltage rating, COG/NP0 dielectric, and tolerance of 5%. When COG/NP0 capacitors are not available for the need of higher capacitance or voltage ratings, X7R dielectrics can be selected.

The tolerance of the other passive components in this circuit can be selected for 1% or above since the components will not directly affect the accuracy of this circuit.

4 Simulation

The TINA-TI™ schematic shown in Figure 5 includes the circuit values obtained in the design process. A dc offset voltage of 124.36 μV and dc quiescent current of 3.797 mA per channel were reported by the simulation.

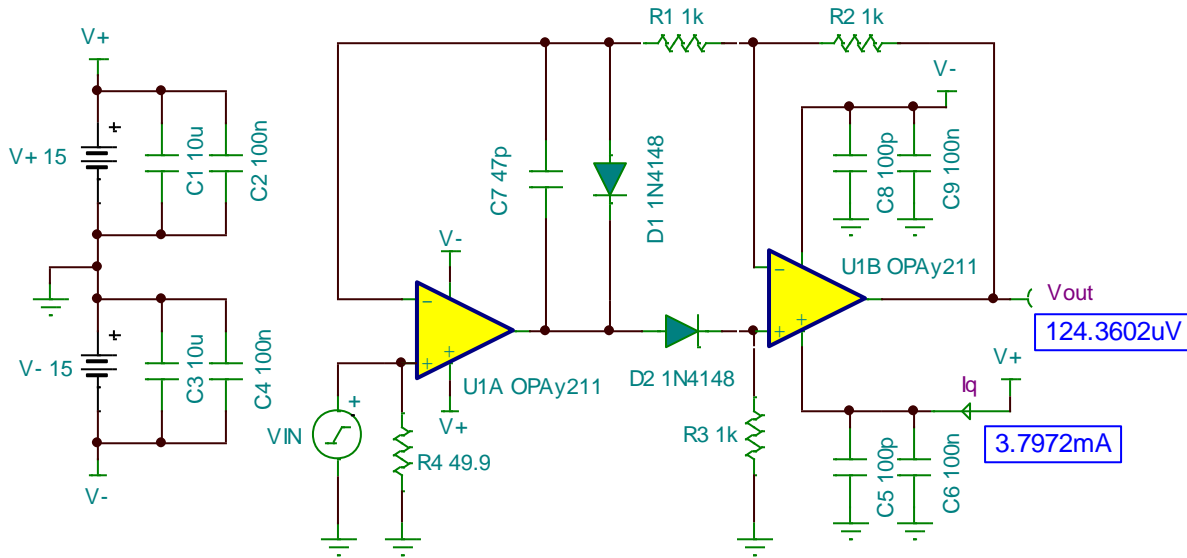

Figure 5: TINA-TI™ simulation schematic showing dc offset and quiescent current

4.1 Transient Response

The transient response of the design with a 20 Vpp, 50 kHz sine-wave input signal is shown in Figure 76. While there is some distortion when the input transitions from negative to positive polarities, it is limited and the output is accurately rectified. With the input at frequencies less than roughly 50 kHz, the output remains very accurately full-wave rectified as displayed with a 1kHz input signal in Figure 7.

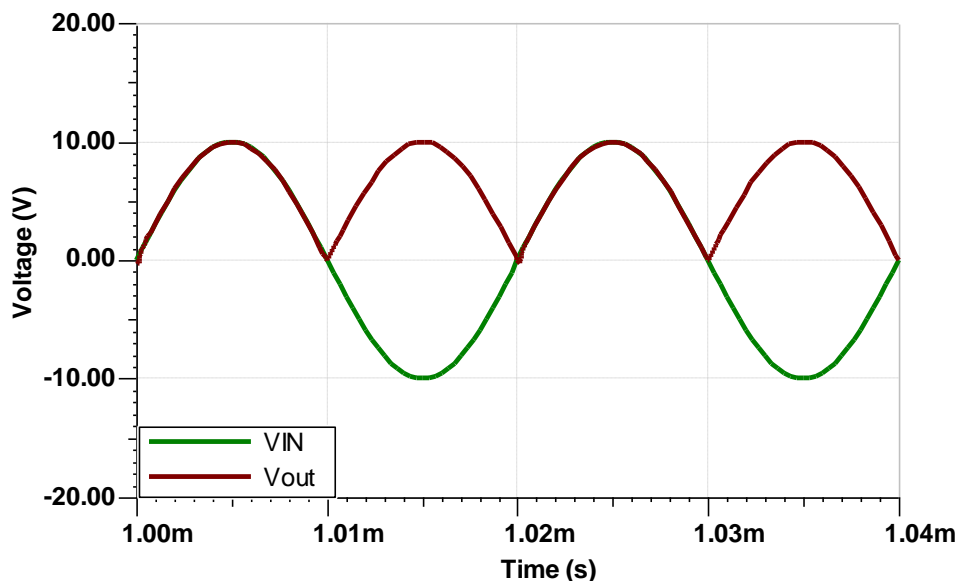

Figure 6: TINA-TI™ simulated transient waveform at +/- 10V and 50 kHz input

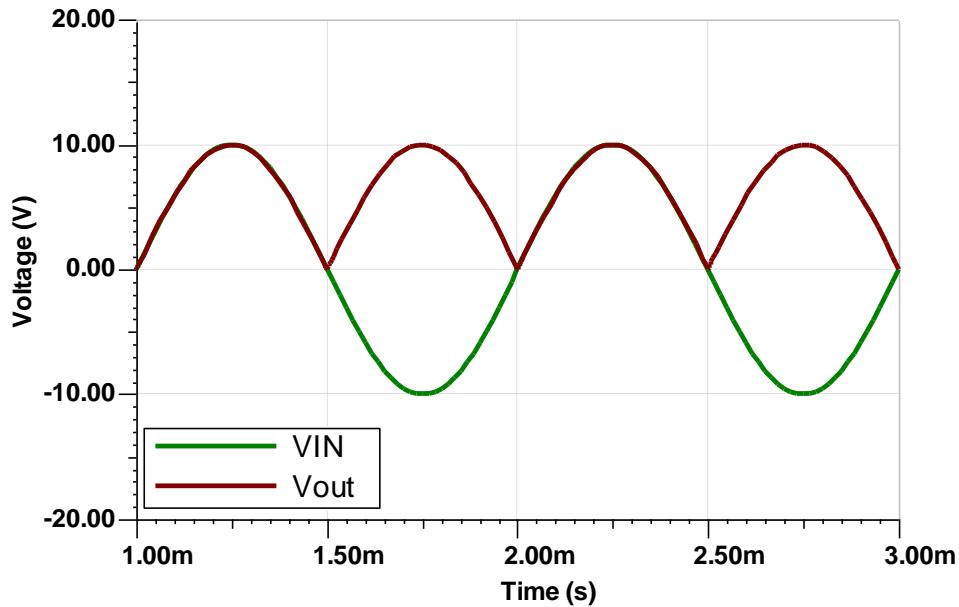

Figure 7: TINA-TI™ simulated transient waveform at +/- 10V and 1 kHz input

The test results with a 20 Vpp input at frequencies of 100 kHz and 200 kHz are shown in Figure 8. The output distortion when the input signal transitions from negative to positive is now very noticeable. The distortion occurs during the time when the circuit transitions from forward biasing D_1 to D_2 . The transition time is caused by the forward voltage (VF), junction capacitance (CJ), and transition time (TT) of the diodes along with the slew rate and output current limitations of U_{1A} . Additional waveforms at other frequencies can be seen in Appendix A.3.

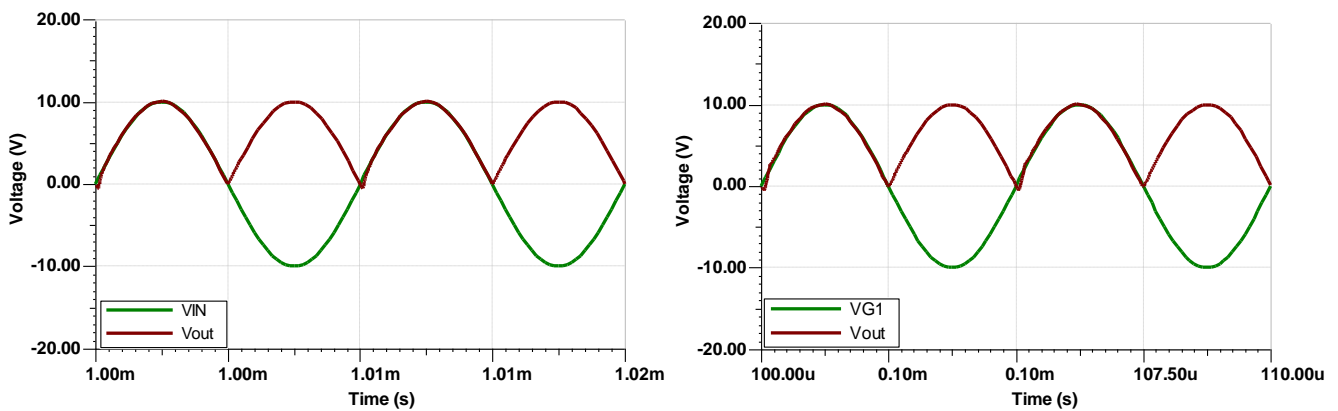

Figure 8: TINA-TI™ Transient simulation for +/- 10V and 100 kHz (left) and 200 kHz (right) sinusoid wave inputs

Figure 9 and Figure 10 show the circuit performance with a 50 mVpp low-level signal at 100 Hz and 1 kHz respectively. Distortion is noticeable for smaller level signals even at 1 kHz.

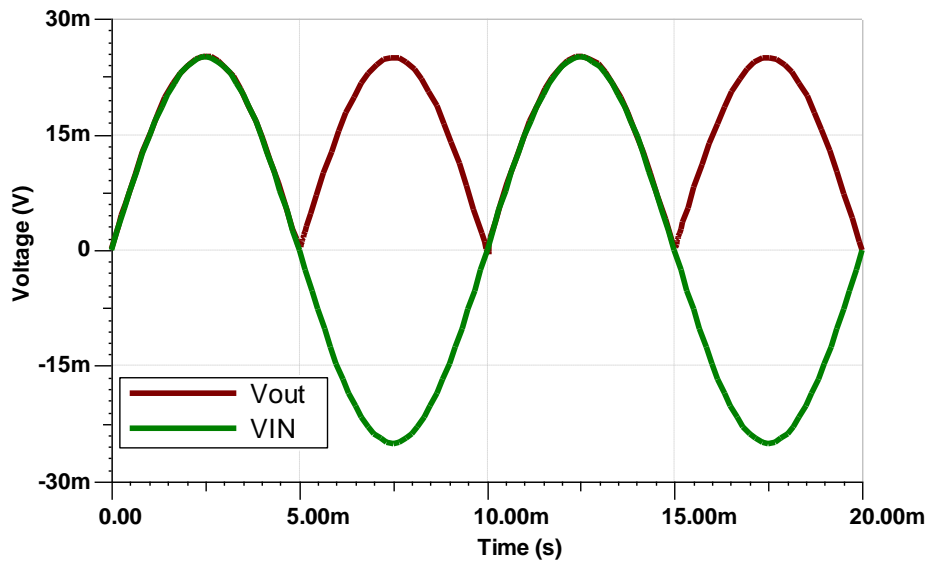

Figure 9: TINA-TI™ simulated output at 100 Hz with 50 mVpp sine-wave input

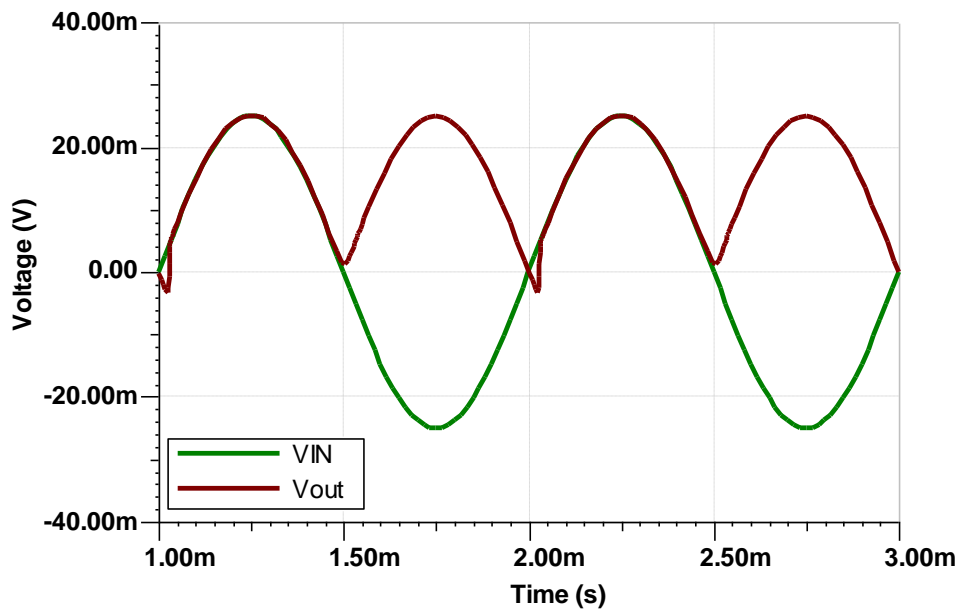

Figure 10: TINA-TI™ simulated output at 1 kHz with 50 mVpp sine-wave input

4.2 Transition Time Simulations

As shown in the previous section, lower level input signals have a lower usable frequency range compared to larger signals. This is because the time it takes to change the biasing of the diodes to switch the polarity of the output increases as the amplitude of the input signal decreases. Figure 11 shows the output transition time for square wave inputs of different amplitudes.

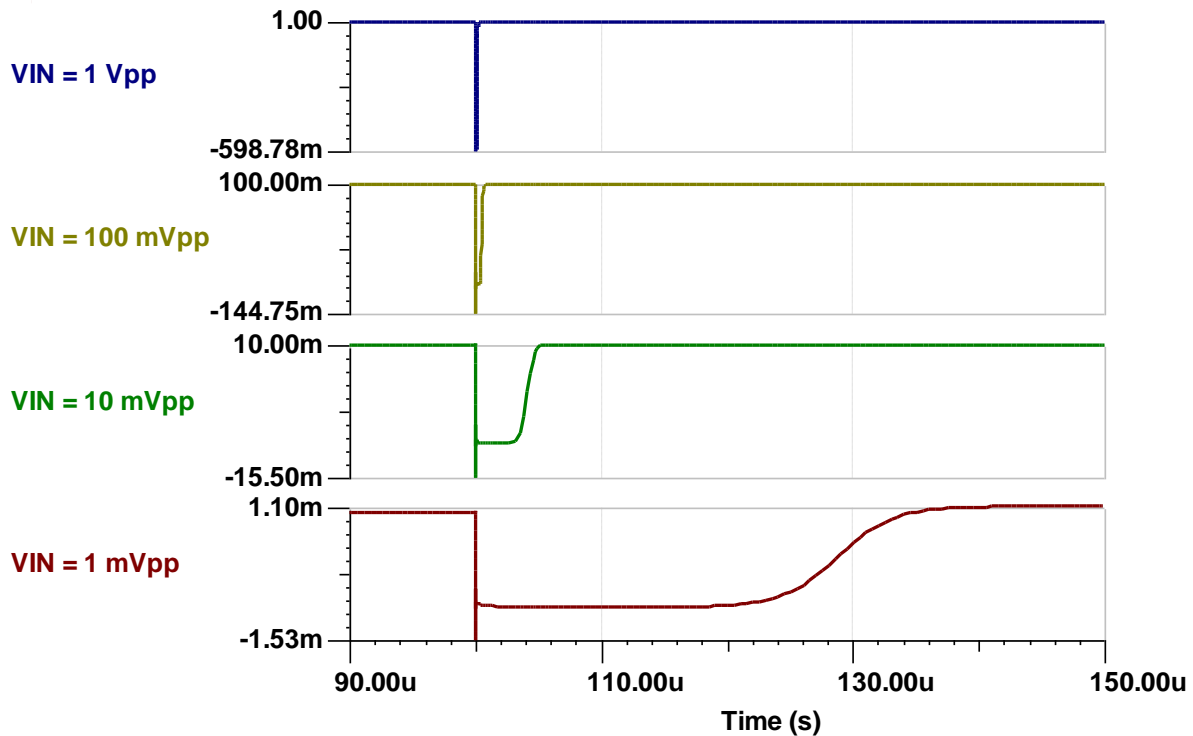

Figure 11: Transition time with different input signal amplitudes

Applying a small square-wave step to the input can also be used to test the small-signal stability of the circuit. The results shown in Figure 12 display little overshoot or ringing, indicating that the system is stable.

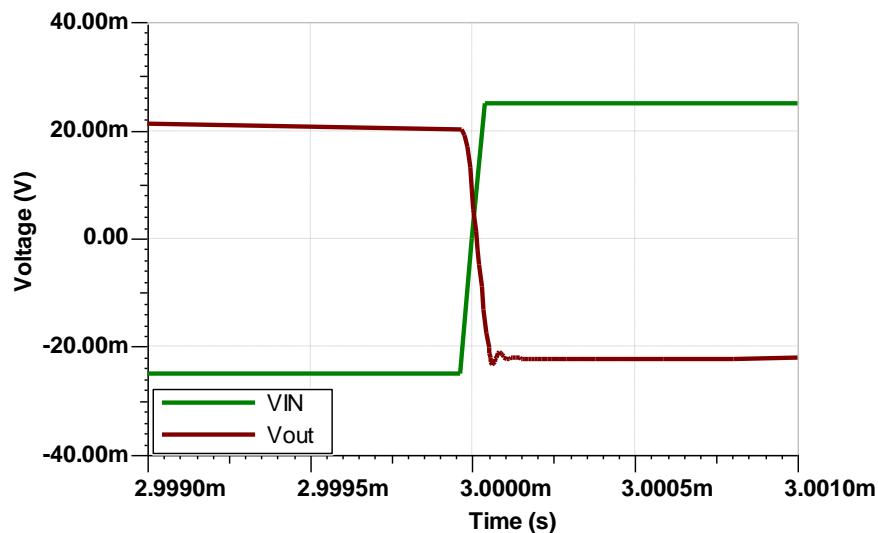

Figure 12: TINA-TI™ simulated output step response with 50 mVpp input

5 PCB Design

The PCB schematic and bill of materials can be found in the Appendix A.1 and A.2.

5.1 PCB Layout

For optimal performance in this design follow standard precision PCB layout guidelines including: using ground planes, proper power supply decoupling, keeping the summing (inverting) node as small as possible, and using short thick traces for sensitive nodes. The layout for the design is shown in Figure 13.

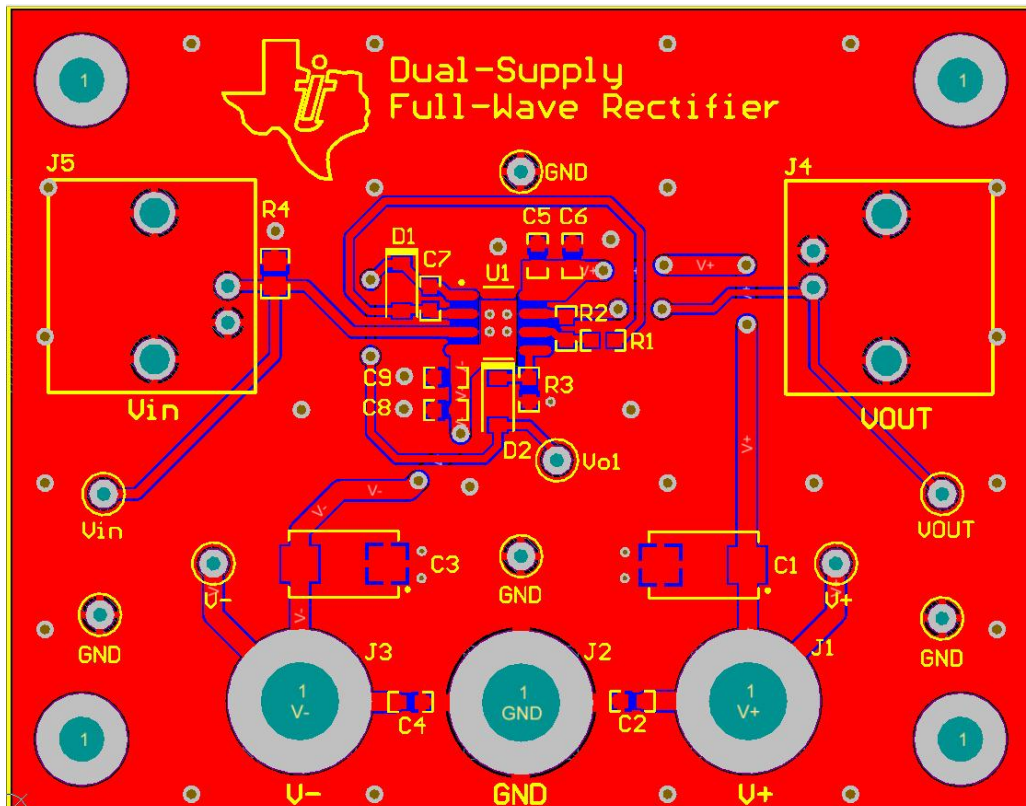

Figure 13: Altium PCB Layout

6 Verification & Measured Performance

6.1 DC Measurements

DC measurements were made for the offset voltage and the quiescent current for five units. The average values are reported in Table 2.

Table 2: Measured dc result summary

	Measured Value
Output Offset Voltage (mV)	0.354
Quiescent Current (mA)	6.8863

6.2 Transient Measurements

The transient response of the design with a 20 Vpp, 1 kHz sine-wave input signal is shown in Figure 14. The design creates a very accurately full-wave rectified output with no obvious distortion.

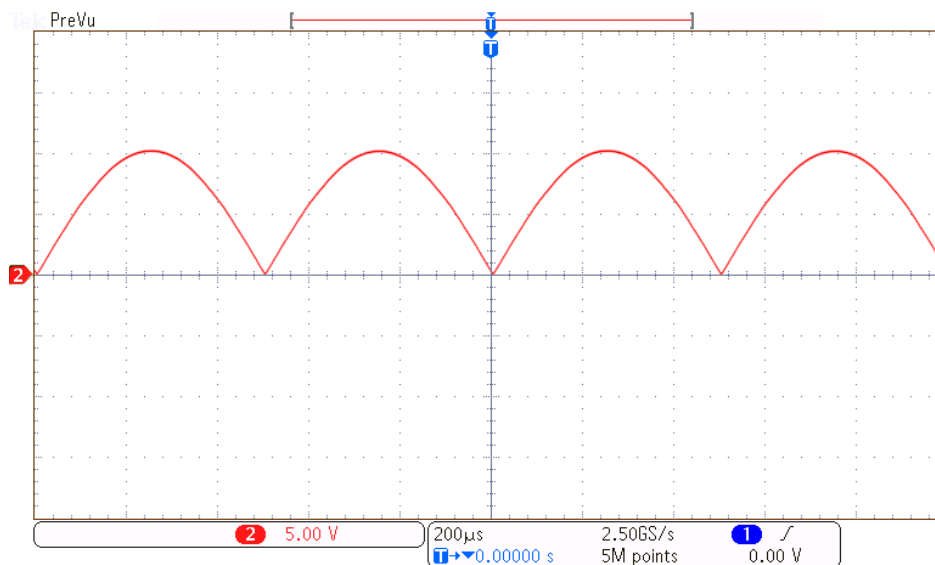

Figure 14: Measured output with 1 kHz, 20 Vpp sine-wave input

The measured results with a 20 Vpp input at the maximum frequency of 100 kHz are shown in Figure 15. The distortion seen in the simulation results can also be seen in the measured results. Additional measured waveforms at other frequencies can be seen in Appendix **Error! Reference source not found.**

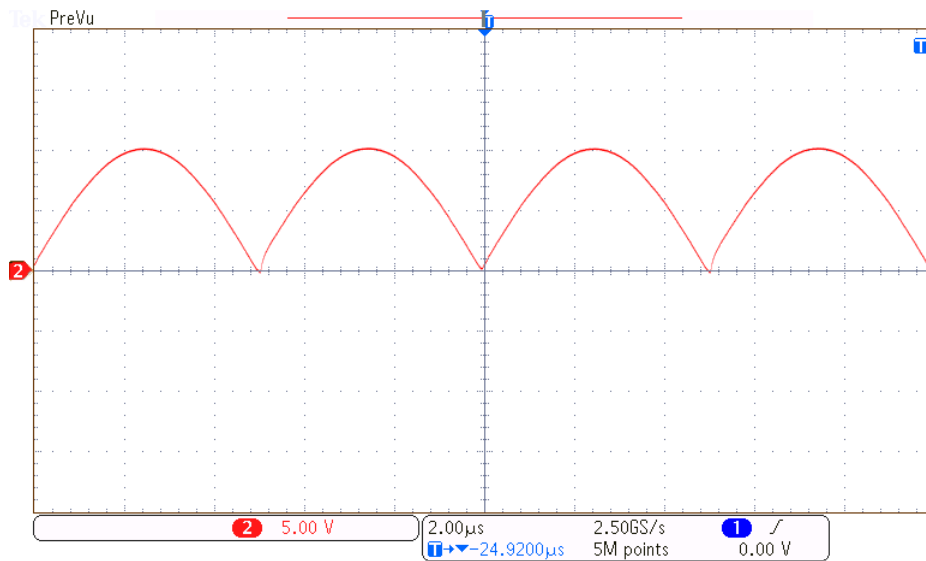

Figure 15: Measured output at 100 kHz, 20 Vpp sine-wave input

Figure 16 and Figure 17 shows low-level signals generation with 50 mVpp at 1 kHz and 5 kHz input respectively. The distortion becomes severe as input frequency increases. The output waveforms match simulation results shown in Figure 10 and Figure 24.

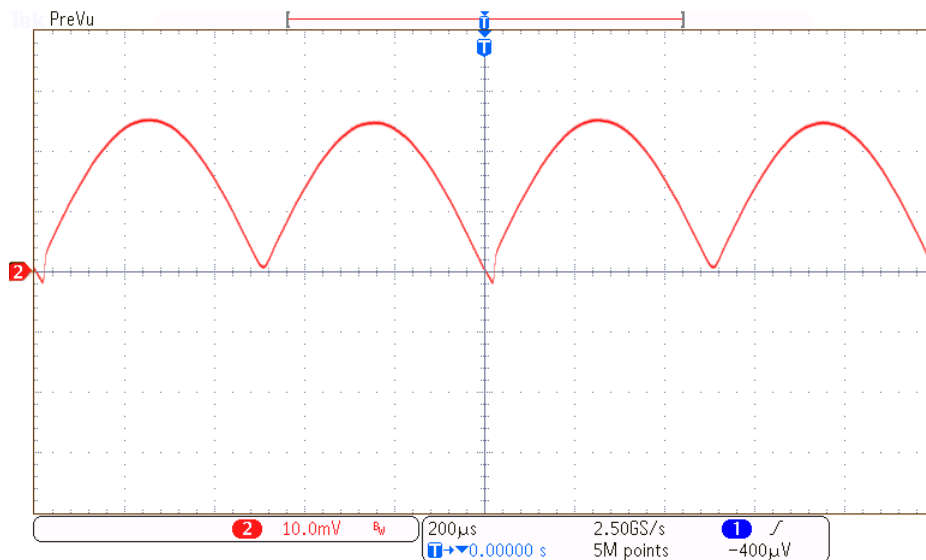

Figure 16: Measured output at 1 kHz, 50 mVpp sine-wave input

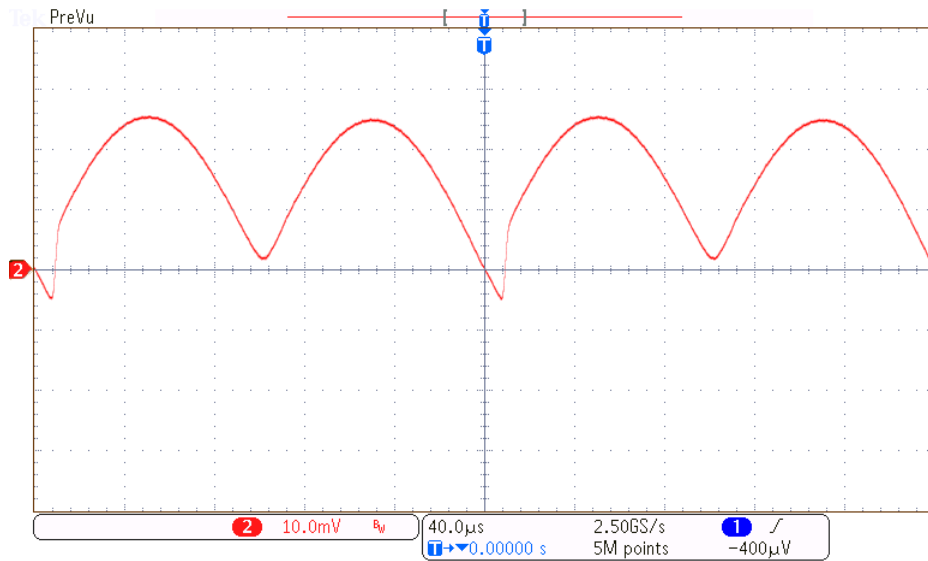

Figure 17: Measured output at 5 kHz, 50 mVpp sine-wave input

6.3 Small-Signal Stability

The small-signal stability of the circuit was tested by applying a step response to the input that caused the output changed by approximately 50 mV. The results are shown in Figure 18. The overshoot and ringing can be further reduced by increasing the value of C_7 or adding capacitors across R_2 at the expense of bandwidth and distortion. Smaller values for R_1 and R_2 will also help improve the small-signal response but the required output current will begin to cause the output voltage to decrease creating an offset between the output and the desired rectified output.

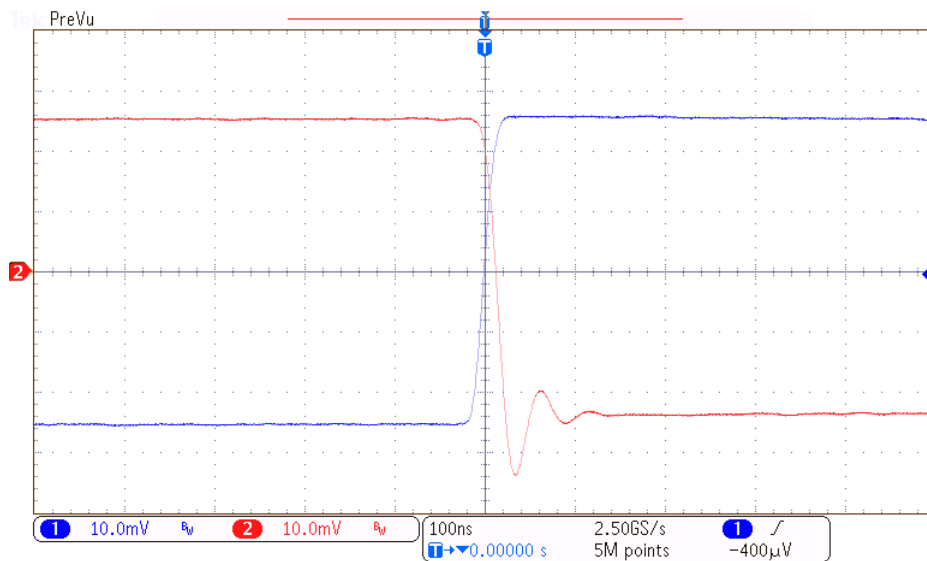

Figure 18: Measured output to 50 mVpp step response

6.4 Measured Result Summary

The measured results show maximum speed at approximately 100 kHz with a 20 Vpp sine-wave input while achieving a low distortion full-wave rectified output. Low-level signals at frequencies less than or equal to 1 kHz can also achieve with good linearity.

7 Modifications

This absolute circuit can be implemented by any op amp with sufficient bandwidth for the input signals. This circuit can process faster signals and be more accurate by applying low noise, low THD, wide bandwidths, high slew rate, and high A_{OL} op amps. Other +/-15 V supply amplifiers suitable for this design are OPA1611, OPA827, OPA1602, OPA1662, and OPA627. The performance of these op amps is summarized in Table 3.

Table 3. Alternate +36V Supply Amplifiers

Amplifier	# of Channel	GBW (MHz)	SR (V/us)	Aol (dB)	Noise at 1 kHz (nV/rtHz)	THD+N at 1 kHz (%)	IB, max (pA)	Iq per channel, max(mA)
OPA1662	2	22	17	114	3.3	0.00006	1200000	1.8
OPA1602	2	35	20	120	2.5	0.00003	200000	2.6
OPA1611	1	40	27	130	1.1	0.000015	250000	3.6
OPA827	1	22	28	126	4	0.00004	10	5.2
OPA627	1	80	135	120	5.2	0.00003	10	7.5

To achieve better performance for low-level signals consider a different full-wave rectifier topology.

8 About the Author

Ting Ye is a field application engineer based in Taipei who supports industrial and precision customers. She performed a six month rotation working with the Precision Linear group where she supported op amp and current loop products for industrial applications.

9 Acknowledgements & References

1. R. Elliott. (2010 Feb. 27) *Precision Rectifiers*. Available: <http://sound.westhost.com/appnotes/an001.htm>
2. D. Jones and M. Stitt. (1997, Dec.). *Precision Absolute Value Circuits*. Available: <http://www.ti.com/lit/an/sboa068/sboa068.pdf>

Appendix A.

A.1 Electrical Schematic

The Altium electrical schematic for this design can be seen in Figure 19.

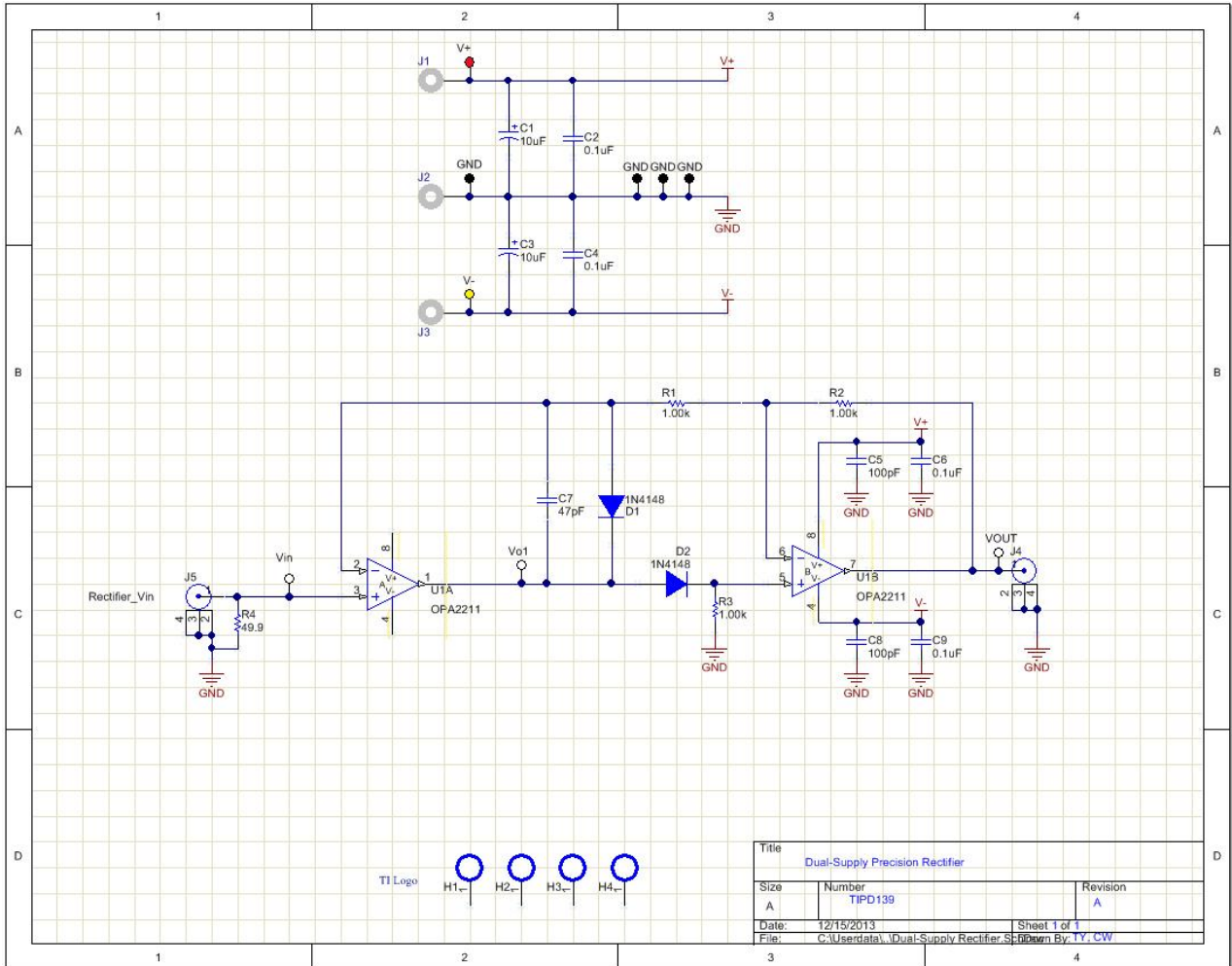

Figure 19: Electrical Schematic

A.2 Bill of Materials

The bill of materials for this circuit can be seen in Figure 20.



TI TEXAS INSTRUMENTS

Bill of Materials

TI DESIGNS
TIPD139: Dual Supply Absolute Value Circuit

Quantity	Value	Designator	Description	Manufacturer	PartNumber
2	10uF	C1, C3	CAP, TANT, 10uF, 50V, +/-10%, 0.4 ohm, 7343-43 SMD	AVX	TPSE106K050R0400
2	0.1uF	C2, C4	CAP, CERM, 0.1uF, 100V, +/-10%, X7R, 0603	MuRata	GRM188R72A104KA35D
4	100pF	C5, C7, C10, C12	CAP, CERM, 100pF, 50V, +/-5%, COG/NP0, 0805	MuRata	GRM2165C1H101JA01D
4	0.1uF	C6, C8, C11, C13	CAP, CERM, 0.1uF, 50V, +/-10%, X7R, 0805	MuRata	GRM21BR71H104KA01L
1	47pF	C9	CAP, CERM, 47pF, 50V, +/-5%, COG/NP0, 0603	Kemet	C0603C470J5GACTU
2	1.25V	D1, D2	Diode, Ultrafast, 100V, 0.15A, SOD-123	Diodes Inc.	1N4148W-7-F
3	NA	J1, J2, J3	Standard Banana Jack, Uninsulated, 5.5mm	Keystone	575-4
2	NA	J4, J5	Connector, TH, SMA	Emerson Network Power	142-0701-201
2	1.00k	R1, R2	RES, 1.00k ohm, 0.1%, 0.1W, 0603	Yageo America	RT0603BRD071KL
1	1.00k	R3	RES, 1.00k ohm, 1%, 0.1W, 0603	Yageo America	RC0603FR-071KL
1	49.9	R4	RES 49.9 OHM 0.20W 0.1% 0805	Vishay Thin Film	PAT0805E49R9BST1
1	Red	TP1	Test Point, TH, Miniature, Red	Keystone	5000
4	Black	TP2, TP3, TP4, TP5	Test Point, TH, Miniature, Black	Keystone	5001
1	Yellow	TP10	Test Point, TH, Miniature, Yellow	Keystone	5004
3	White	TP11, TP12, TP13	Test Point, TH, Miniature, White	Keystone	5002
2	NA	U1, U2	IC OPAMP GP 80MHZ RRO 8SOPWRPAD	Texas Instruments	OPA2211AIDDA

Figure 20: Bill of Materials

A.3 Additional Simulated Data

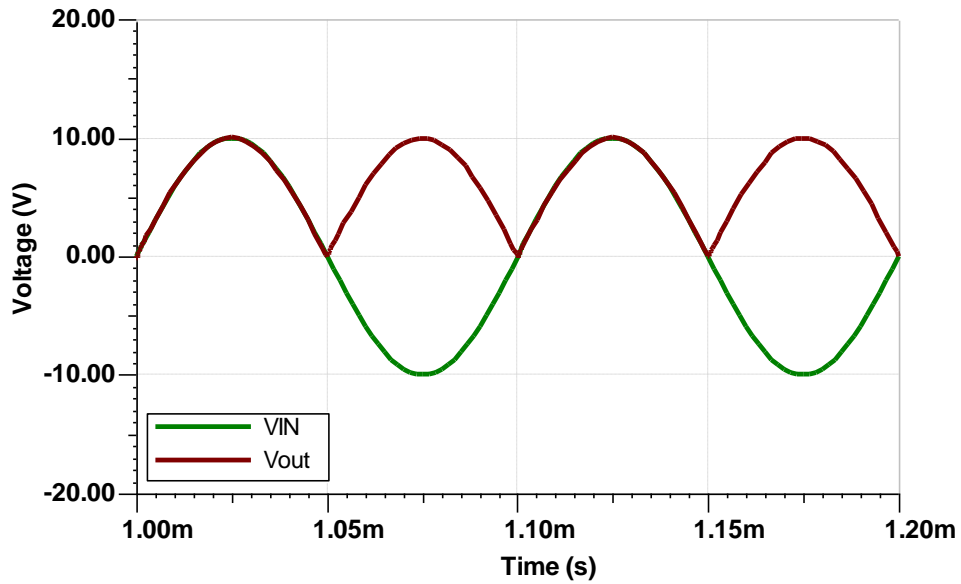

A. Transient simulation for +/- 10V and 10 kHz sinusoid wave input

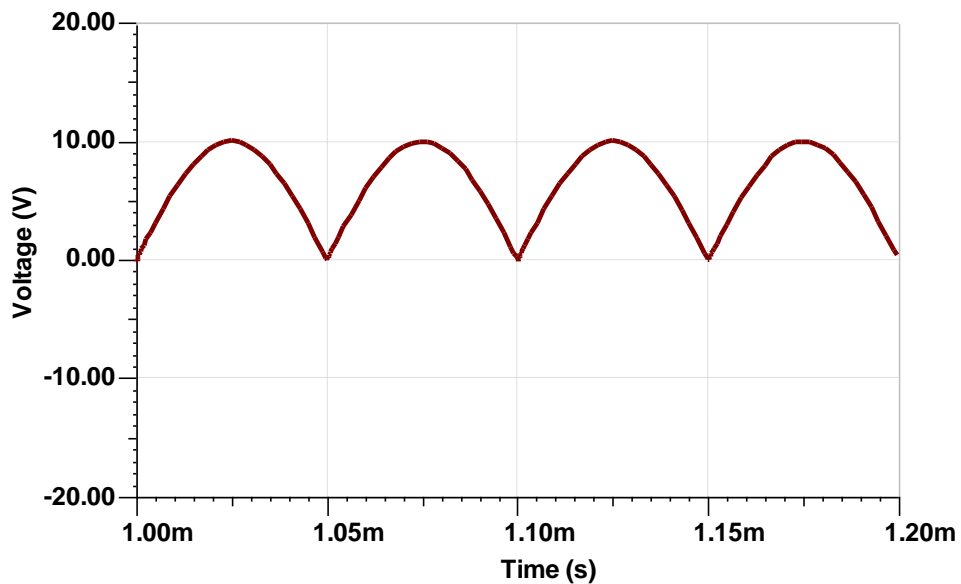

B. Simulated output at +/- 10V and 10 kHz sinusoid wave input

Figure 21: TINA-TI™ simulated transient waveform at +/- 10V and 10 kHz input

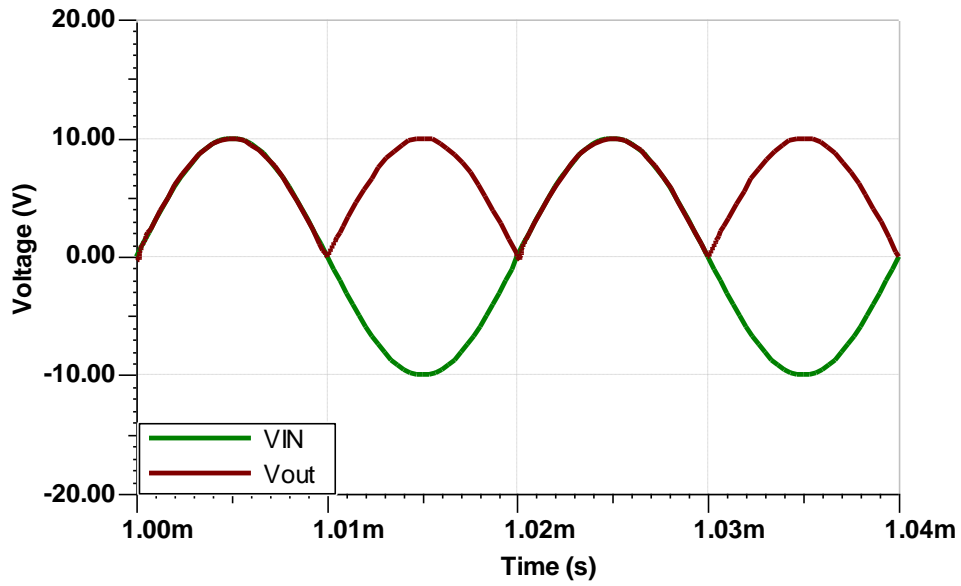

A. Transient simulation for +/- 10V and 50 kHz sinusoid wave input

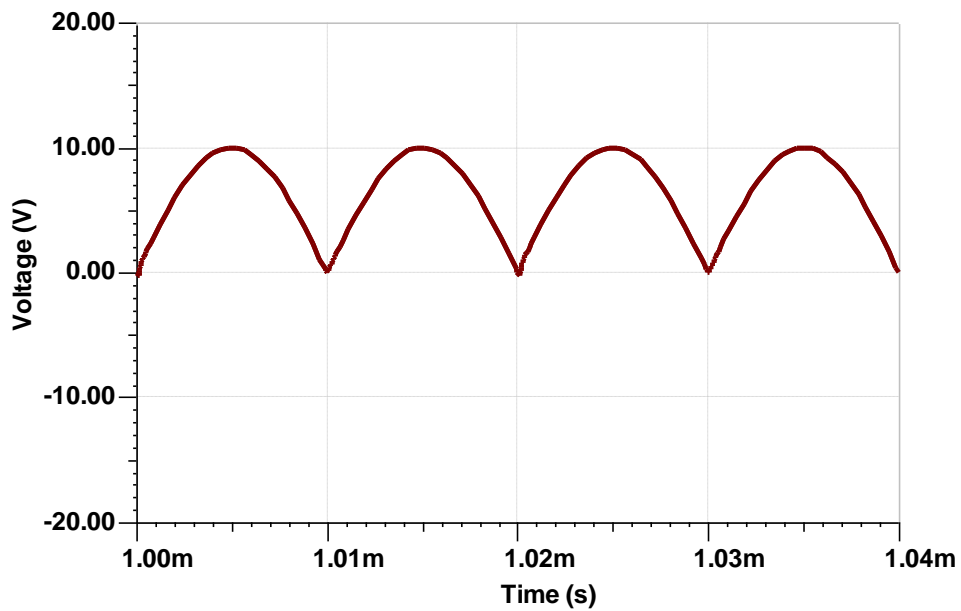

B. Simulated output at +/- 10V and 50 kHz sinusoid wave input

Figure 22: TINA-TI™ simulated transient waveform at +/- 10V and 50 kHz input

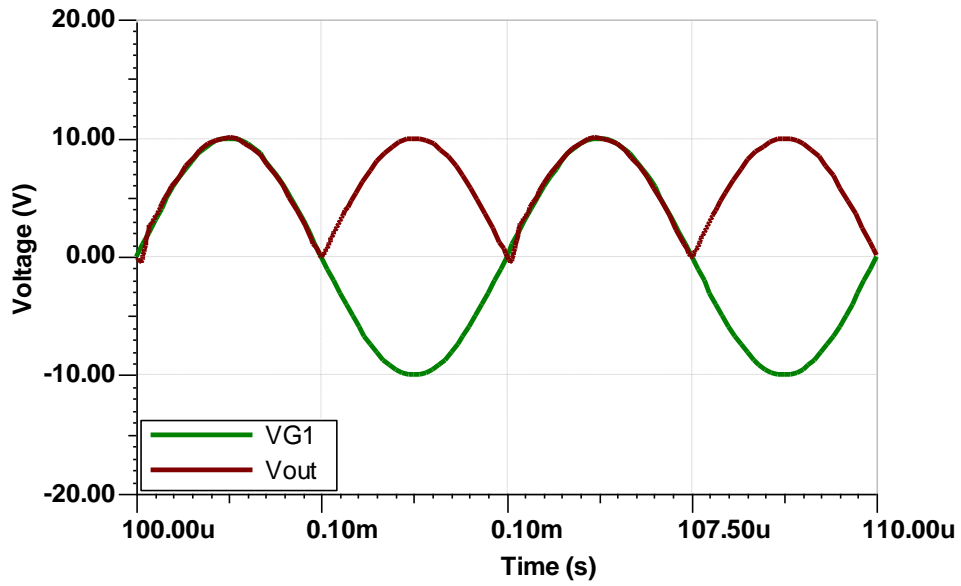

A. Transient simulation for +/- 10V and 200 kHz sinusoid wave input

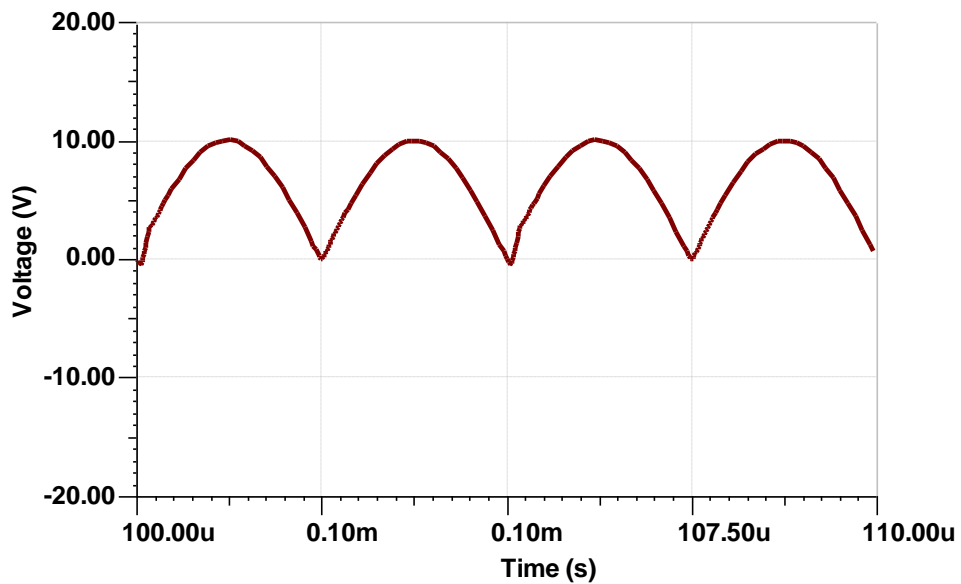

B. Simulated output at +/- 10V and 200 kHz sinusoid wave input

Figure 23: TINA-TI™ simulated transient waveform at +/- 10V and 200 kHz input

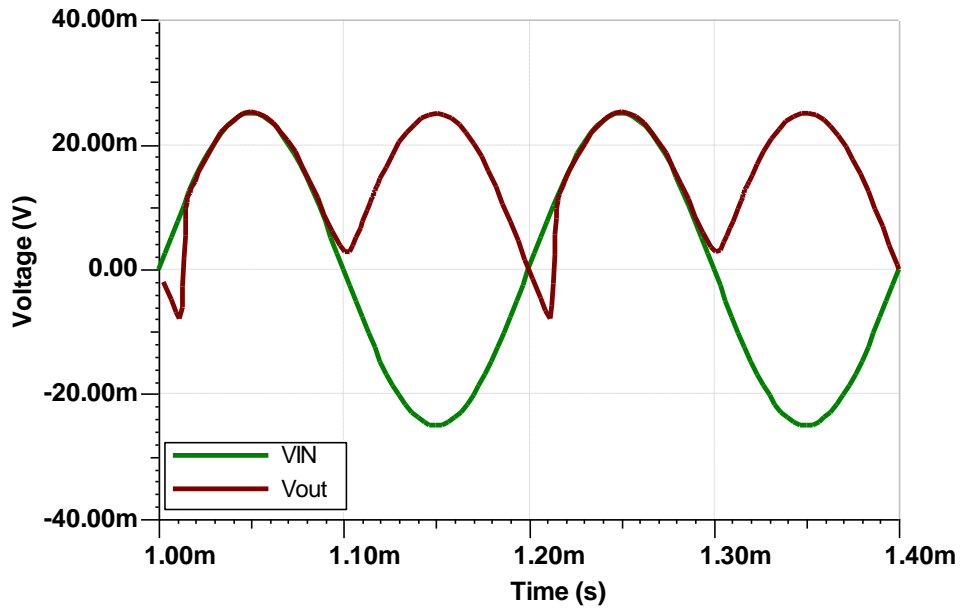

Figure 24: TINA-TI™ simulated output at 5 kHz with 50 mVpp sine-wave input

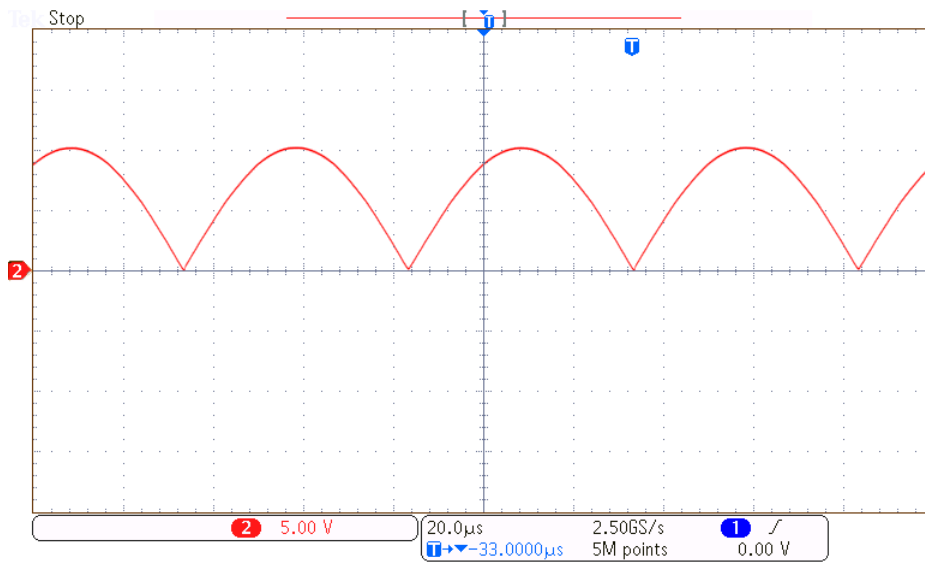

Figure 25: Measured output at 10 kHz with 20 Vpp sine-wave input

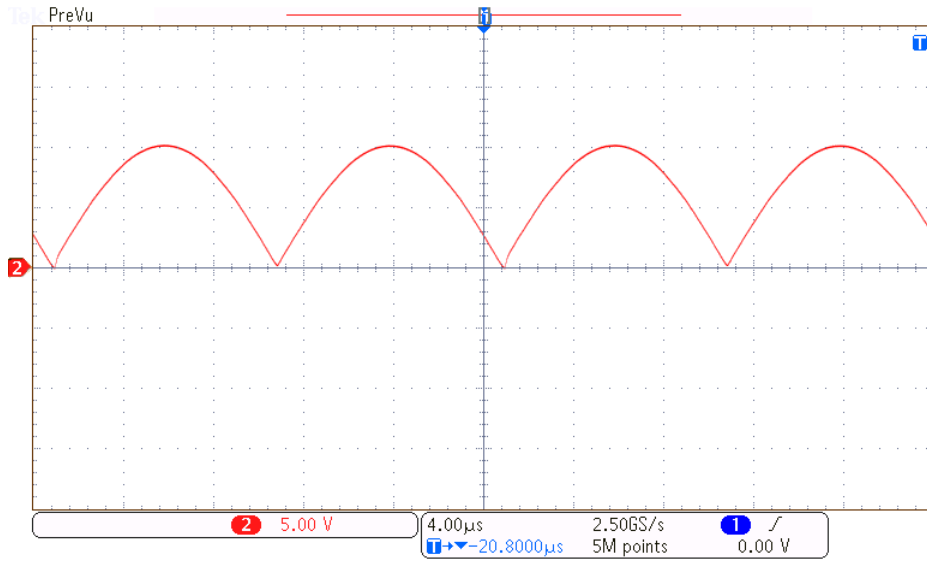

Figure 26: Measured output at 50 kHz with 20 Vpp sine-wave input

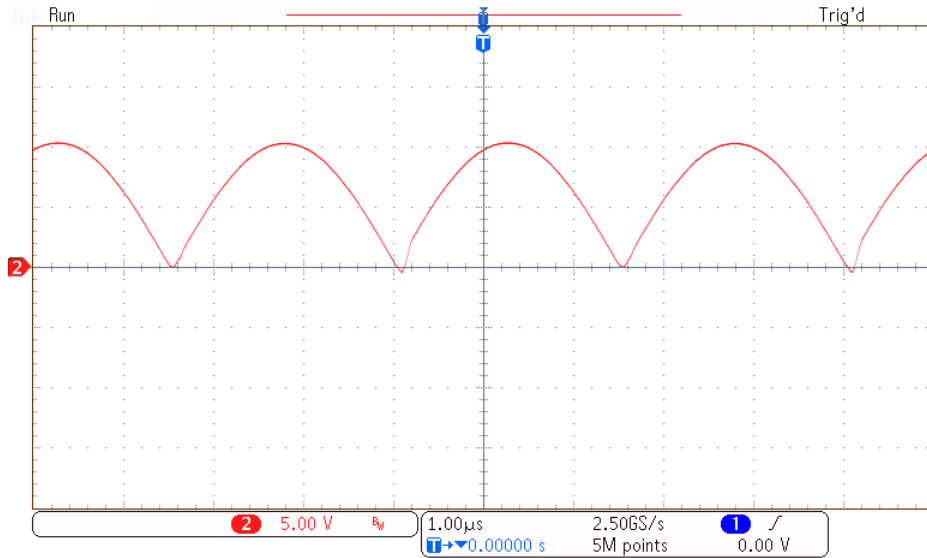

Figure 27: Measured output at 200 kHz with 20 Vpp sine-wave input

A.4 Output Fast Fourier Transform (FFT)

The output FFT shown in Figure 28 was taken from 20 Hz to 10 kHz to view the output spectrum of the circuit with a 1 Vpp, 1 kHz input signal. Since harmonics of a full wave rectifier are double the base frequency, the harmonic tones are even harmonics at 2, 4, 6, 8, 10 kHz.

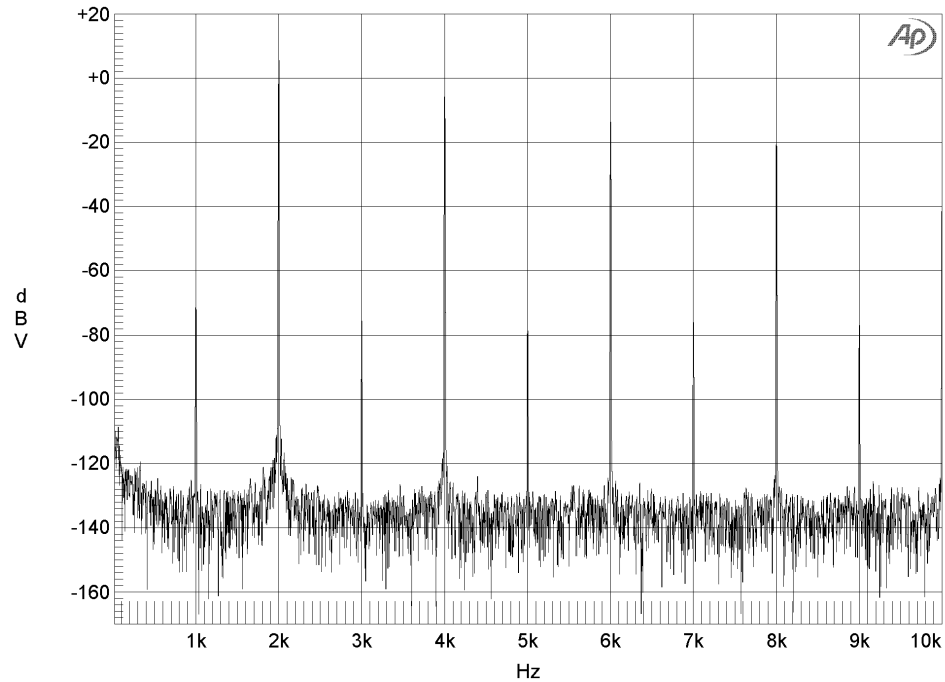

Figure 28: Output FFT with 1 kHz, 20 Vpp sine-wave input

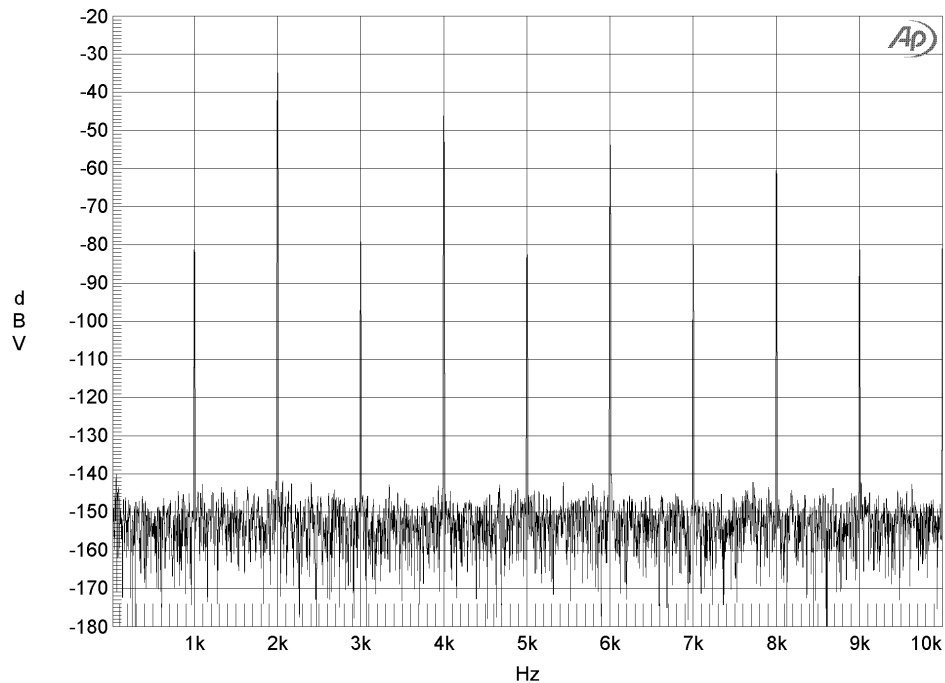

Figure 29: FFT of output at 1 kHz with 100 mVpp sine-wave

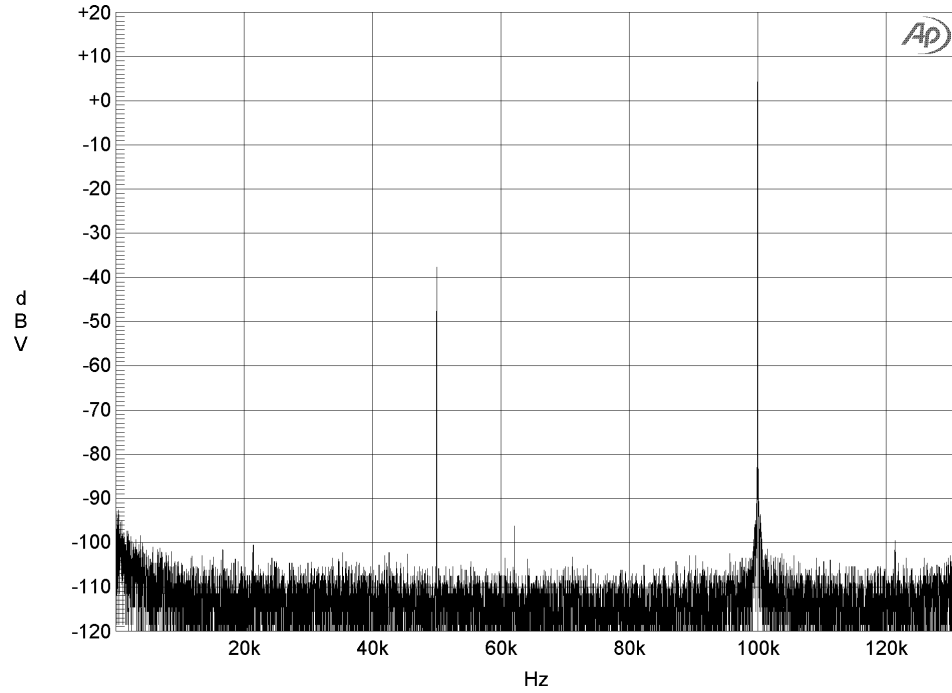

Figure 30: FFT of output at input 50 kHz with 20 Vpp sine-wave

IMPORTANT NOTICE FOR TI REFERENCE DESIGNS

Texas Instruments Incorporated ("TI") reference designs are solely intended to assist designers ("Buyers") who are developing systems that incorporate TI semiconductor products (also referred to herein as "components"). Buyer understands and agrees that Buyer remains responsible for using its independent analysis, evaluation and judgment in designing Buyer's systems and products.

TI reference designs have been created using standard laboratory conditions and engineering practices. **TI has not conducted any testing other than that specifically described in the published documentation for a particular reference design.** TI may make corrections, enhancements, improvements and other changes to its reference designs.

Buyers are authorized to use TI reference designs with the TI component(s) identified in each particular reference design and to modify the reference design in the development of their end products. HOWEVER, NO OTHER LICENSE, EXPRESS OR IMPLIED, BY ESTOPPEL OR OTHERWISE TO ANY OTHER TI INTELLECTUAL PROPERTY RIGHT, AND NO LICENSE TO ANY THIRD PARTY TECHNOLOGY OR INTELLECTUAL PROPERTY RIGHT, IS GRANTED HEREIN, including but not limited to any patent right, copyright, mask work right, or other intellectual property right relating to any combination, machine, or process in which TI components or services are used. Information published by TI regarding third-party products or services does not constitute a license to use such products or services, or a warranty or endorsement thereof. Use of such information may require a license from a third party under the patents or other intellectual property of the third party, or a license from TI under the patents or other intellectual property of TI.

TI REFERENCE DESIGNS ARE PROVIDED "AS IS". TI MAKES NO WARRANTIES OR REPRESENTATIONS WITH REGARD TO THE REFERENCE DESIGNS OR USE OF THE REFERENCE DESIGNS, EXPRESS, IMPLIED OR STATUTORY, INCLUDING ACCURACY OR COMPLETENESS. TI DISCLAIMS ANY WARRANTY OF TITLE AND ANY IMPLIED WARRANTIES OF MERCHANTABILITY, FITNESS FOR A PARTICULAR PURPOSE, QUIET ENJOYMENT, QUIET POSSESSION, AND NON-INFRINGEMENT OF ANY THIRD PARTY INTELLECTUAL PROPERTY RIGHTS WITH REGARD TO TI REFERENCE DESIGNS OR USE THEREOF. TI SHALL NOT BE LIABLE FOR AND SHALL NOT DEFEND OR INDEMNIFY BUYERS AGAINST ANY THIRD PARTY INFRINGEMENT CLAIM THAT RELATES TO OR IS BASED ON A COMBINATION OF COMPONENTS PROVIDED IN A TI REFERENCE DESIGN. IN NO EVENT SHALL TI BE LIABLE FOR ANY ACTUAL, SPECIAL, INCIDENTAL, CONSEQUENTIAL OR INDIRECT DAMAGES, HOWEVER CAUSED, ON ANY THEORY OF LIABILITY AND WHETHER OR NOT TI HAS BEEN ADVISED OF THE POSSIBILITY OF SUCH DAMAGES, ARISING IN ANY WAY OUT OF TI REFERENCE DESIGNS OR BUYER'S USE OF TI REFERENCE DESIGNS.

TI reserves the right to make corrections, enhancements, improvements and other changes to its semiconductor products and services per JESD46, latest issue, and to discontinue any product or service per JESD48, latest issue. Buyers should obtain the latest relevant information before placing orders and should verify that such information is current and complete. All semiconductor products are sold subject to TI's terms and conditions of sale supplied at the time of order acknowledgment.

TI warrants performance of its components to the specifications applicable at the time of sale, in accordance with the warranty in TI's terms and conditions of sale of semiconductor products. Testing and other quality control techniques for TI components are used to the extent TI deems necessary to support this warranty. Except where mandated by applicable law, testing of all parameters of each component is not necessarily performed.

TI assumes no liability for applications assistance or the design of Buyers' products. Buyers are responsible for their products and applications using TI components. To minimize the risks associated with Buyers' products and applications, Buyers should provide adequate design and operating safeguards.

Reproduction of significant portions of TI information in TI data books, data sheets or reference designs is permissible only if reproduction is without alteration and is accompanied by all associated warranties, conditions, limitations, and notices. TI is not responsible or liable for such altered documentation. Information of third parties may be subject to additional restrictions.

Buyer acknowledges and agrees that it is solely responsible for compliance with all legal, regulatory and safety-related requirements concerning its products, and any use of TI components in its applications, notwithstanding any applications-related information or support that may be provided by TI. Buyer represents and agrees that it has all the necessary expertise to create and implement safeguards that anticipate dangerous failures, monitor failures and their consequences, lessen the likelihood of dangerous failures and take appropriate remedial actions. Buyer will fully indemnify TI and its representatives against any damages arising out of the use of any TI components in Buyer's safety-critical applications.

In some cases, TI components may be promoted specifically to facilitate safety-related applications. With such components, TI's goal is to help enable customers to design and create their own end-product solutions that meet applicable functional safety standards and requirements. Nonetheless, such components are subject to these terms.

No TI components are authorized for use in FDA Class III (or similar life-critical medical equipment) unless authorized officers of the parties have executed an agreement specifically governing such use.

Only those TI components that TI has specifically designated as military grade or "enhanced plastic" are designed and intended for use in military/aerospace applications or environments. Buyer acknowledges and agrees that any military or aerospace use of TI components that have **not** been so designated is solely at Buyer's risk, and Buyer is solely responsible for compliance with all legal and regulatory requirements in connection with such use.

TI has specifically designated certain components as meeting ISO/TS16949 requirements, mainly for automotive use. In any case of use of non-designated products, TI will not be responsible for any failure to meet ISO/TS16949.