

Temperature sensors: PCB guidelines for surface mount devices

Ben Kasemsadeh, Aaron Heng, and Amit Ashara

ABSTRACT

Power hungry electronic components such as CPUs, GPUs, or FPGAs, as well as voltage regulators heat up during operation. Some applications require ambient air temperature measurements while others need to measure the temperature of a nearby component on the PCB. Measuring ambient air temperature with a surface mount technology (SMT) device is challenging due to the thermal influence of other components within the system. In other systems, in which the temperature of a component needs to be measured, ambient air temperature can influence and degrade the measurement accuracy.

The system designer needs to make certain design decisions regarding both package type and PCB layout when integrating a temperature sensor. This application note provides recommendations to system designers and explains methods for improving the accuracy of the temperature point being measured. The Recommendations are provided both for air temperature measurements and for component temperature measurement. The report details layout techniques, device orientation, and best practices for mounting.

Contents

1	Introduction	2
	1.1 What Is Heat Conduction?.....	2
	1.2 Determining The Dominant Thermal Conduction Path Of Selected Package Types	3
	1.3 Determining Thermal Conduction Through The PCB	7
2	Design Guidelines For Air Temperature Measurement	11
	2.1 Ground Plane Considerations	11
	2.2 Partitioning the PCB	13
	2.3 Isolation Island	14
	2.4 Perforation.....	15
	2.5 Edge Connector	16
	2.6 Controlling the Thermal Mass of the PCB	17
3	Design Guidelines For Component Temperature Measurement.....	18
	3.1 Location.....	18
4	Summary	20

Trademarks

All trademarks are the property of their respective owners.

1 Introduction

1.1 What Is Heat Conduction?

There are three methods of heat transfer: heat conduction through solids, heat convection through fluids and gases, and heat generated by radiation. This report focuses on heat conduction as it dominates the heat transfer in PCBs and is therefore most relevant to temperature measurements.

Heat conduction is defined as the transfer of heat through a volume or a body. Heat is transferred through microscopic collisions of particles; the more collisions, the hotter the object is. Heat transfer occurs when there is a temperature difference between two objects or between different areas of an object, and its rate depends on the geometry, thickness, and material of the object. Due to the law of equilibrium, heat transfers from a hotter body to a colder body until the whole system reaches final equilibrium, as shown in [Figure 1](#). There is no net heat transfer between two objects that are equilibrium temperature. The equation for heat transfer through conduction is shown in [Equation 1](#)

$$\frac{Q}{t} = kA \frac{(T_2 - T_1)}{d}$$

where

- Q/t: The rate of heat transfer [J/s]
- k: the thermal conductivity of the material [W/m×K]
- A: Surface of the contact area [m²]
- ΔT: The temperature difference of T1 temperature of one object and T2 temperature of the other [K]
- d: The thickness of the material [m]

(1)

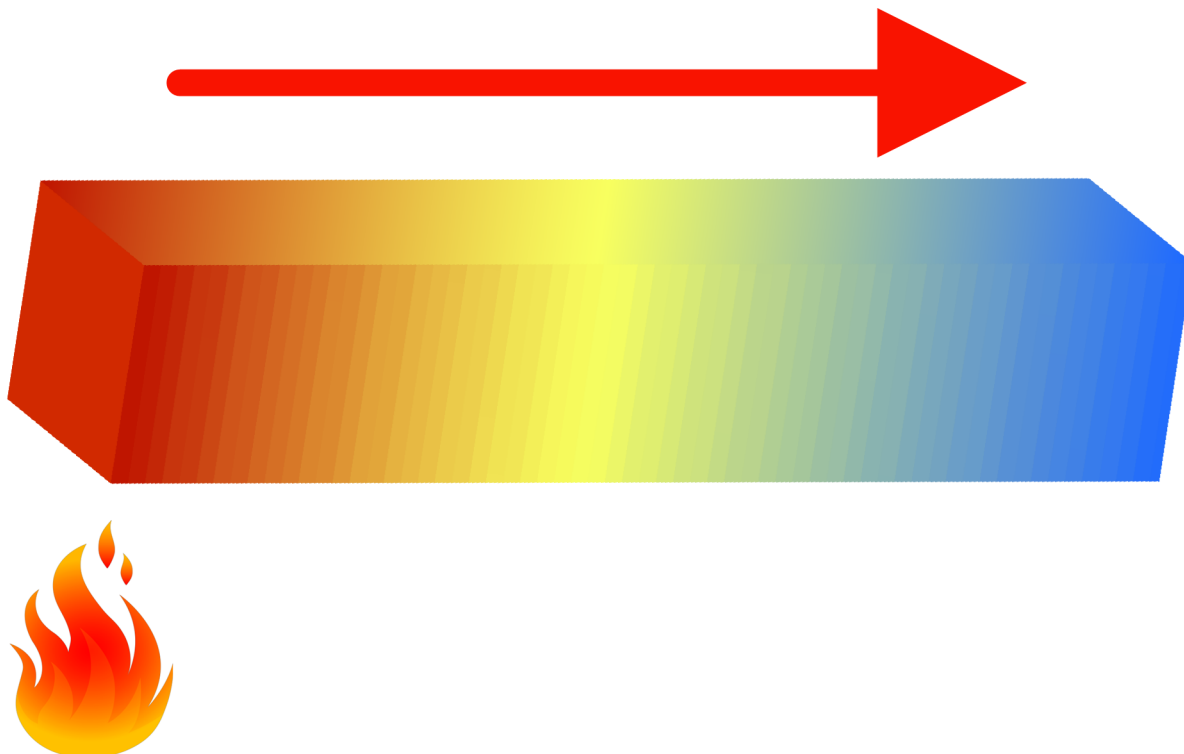

Figure 1. Thermal Conduction Model

Thermal conductivity (k) is the measure of a material's capability to conduct heat. It is used to describe how heat conducts through a material. Metals are highly thermally conductive whereas materials like air, wool, paper, or plastic are poor conductors of heat. Materials with a very low thermal conductivity, such as polystyrene foam, act like a thermal insulator.

The materials that are most relevant to thermal analysis of PCBs are copper, FR4, and solder mask. Copper is an excellent conductor of heat; it conducts heat significantly faster than FR4. [Table 1](#) lists the thermal conductivities found in PCBs. The higher the value, the more efficient the material is in transferring heat, which results in a shorter thermal response time. For low k values, the temperature gradient between the source and the sensor can be significantly large and must be considered carefully during layout.

Table 1. Material Thermal Conductivity Coefficients Of Selected Materials

Material	Thermal Conductivity k [W/(m×K)]
Air	0.0275
Solder Mask	0.245
FR4	0.25
Gold	314
Copper	385
Silver	406

1.2 Determining The Dominant Thermal Conduction Path Of Selected Package Types

Surface mount temperature sensors offer several advantages over sensors with through-hole packages. Advantages include a smaller package size with a low profile, convenient PCB placement, and ease of assembly. However, SMT temperature sensors can be difficult to isolate because they have the tendency to measure the PCB temperature rather than ambient air temperature. Therefore, special layout techniques need to be employed if the objective of the temperature sensor is to measure the ambient temperature rather than the PCB temperature. Local analog or digital temperature sensors determine temperature by measuring their own die temperature. Therefore, it is important to understand the dominant temperature conduction paths between the die of the temperature sensor and the object or environment whose temperature is to be determined.

Heat is conducted primarily through the following paths:

1. The Die-attach pad (DAP), if present, provides the most dominant thermal path between the PCB and the die
2. The leads provide the most significant thermal path if the package type does not include a DAP
3. The mold compound provides an additional thermal path, but due to its low thermal conductivity, any heat transfer through the mold compound itself is slower than heat transfer through the leads or DAP.

The package type choice determines how quickly the temperature sensor can respond to changes in temperature. [Figure 2](#) shows the relative thermal response rates of different classes of selected SMT package types that are used for temperature measurements.

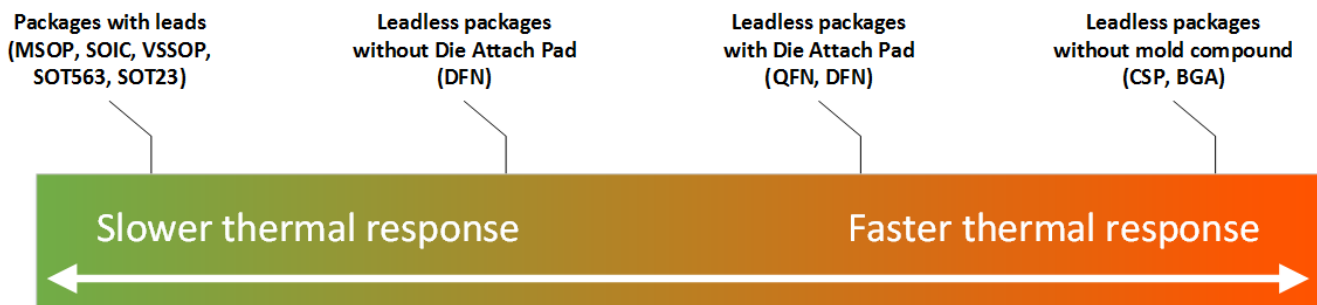

Figure 2. Relative Thermal Response Rate (Typical)

Package types without a mold compound (CSP, DSBGA) and packages with a DAP (QFN, DFN) are well suited if a fast thermal heat transfer from the PCB is desired, while package types without DAP are better in applications in which slower response rates are desired. A fast thermal response rate allows the temperature sensor to respond to any temperature changes quickly and therefore provide an accurate reading.

Sections [Section 1.2.2](#) to [Section 1.2.1](#) show cross sections of commonly used SMT package types for Texas Instruments' temperature sensors.

1.2.1 Leadless Packages Without Mold Compound (CSP, DSBGA)

Wafer Chip Scale Package (WCSP) leads are Ball Grid Array (BGA) balls processed directly onto the die. Heat from the BGA balls are directly transferred to the die instead of transferring over the pins or through a die attach pad, as shown in [Figure 3](#). Generally, this is the package type with the fastest thermal response because there is no mold to heat up.

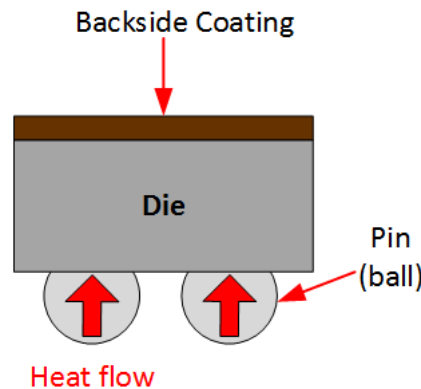

Figure 3. Heat Transfer WCSP (LMT70[YFQ], TMP103[YFF], TMP108[YFF]) Package Cross Section

1.2.2 Leadless Packages With Die Attach Pad (QFN, DFN)

Packages with a DAP, such as QFN and DFN packages, have a large exposed surface area through which heat can transfer quickly. These package types will respond quickly to temperature changes of the copper plane which the DAP is soldered onto. Because the die sits directly on top of the thermal pad, heat can transfer rapidly from the thermal pad to the die.

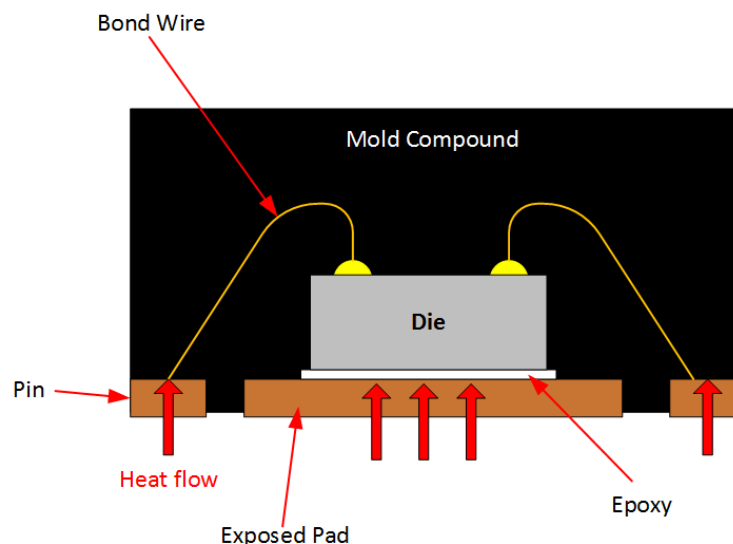

Figure 4. Heat Transfer WSON (TMP116[DRV]) Package Cross Section

1.2.3 Leadless Packages Without Die Attach Pad (DFN)

Leadless packages without a DAP, such as the 2-pin DFN package of the LMT01 shown in [Figure 5](#), transfer most heat through the pins itself. A small package of this type can still respond to temperature change quickly because of its small thermal mass of the mold compound.

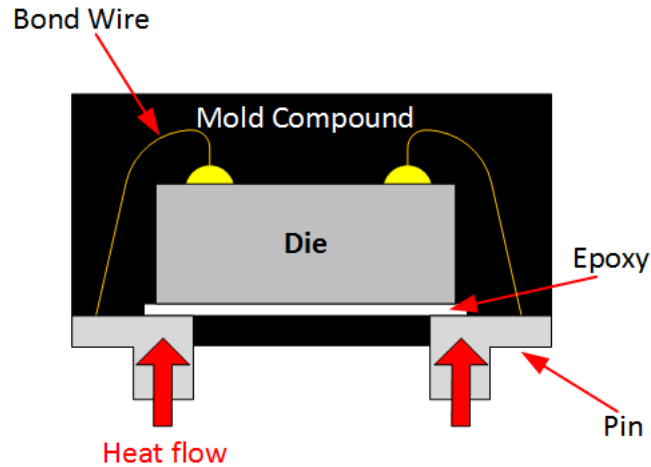

Figure 5. Heat Transfer WSON (LMT01[DQX]) Package Cross Section

1.2.4 Packages With Leads (MSOP, SOIC, VSSOP, SOT563, SOT23)

Other packages such as SOIC8, MSOP8, SOT563, and SOT23 transfer most heat through their leads. The leads transfer 60% to 70% heat to the die thermal sensor.

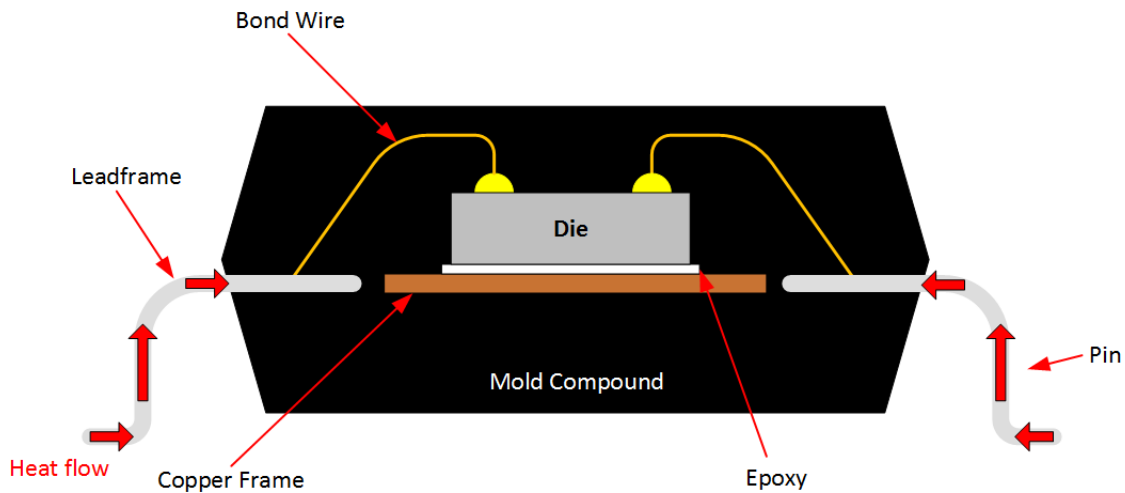

Figure 6. Heat Transfer MSOP8, SOIC8 (LM75[D], TMP75[D]) Package Cross Section

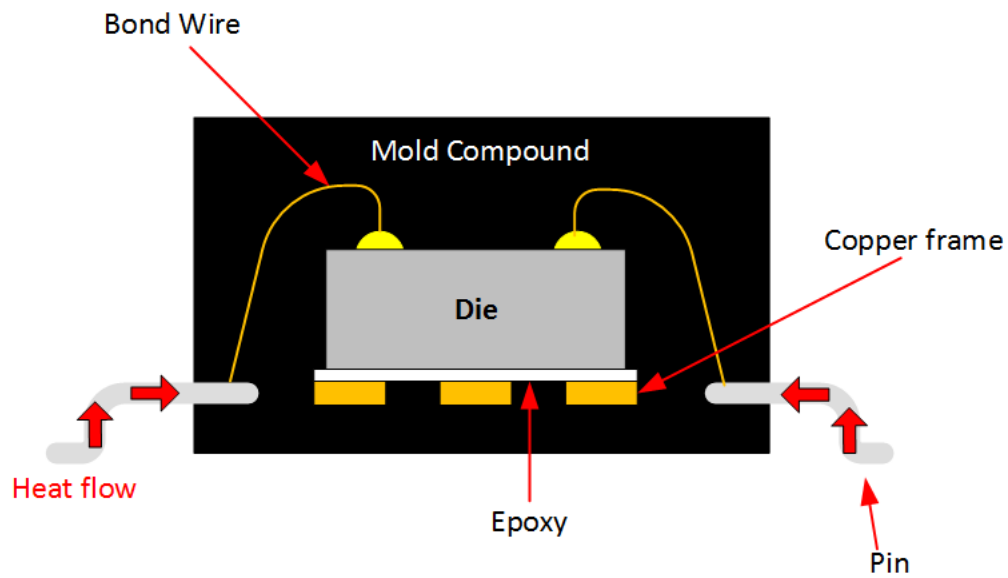

Figure 7. Heat Transfer SOT563 (TMP102[DRL]) Package Cross Section

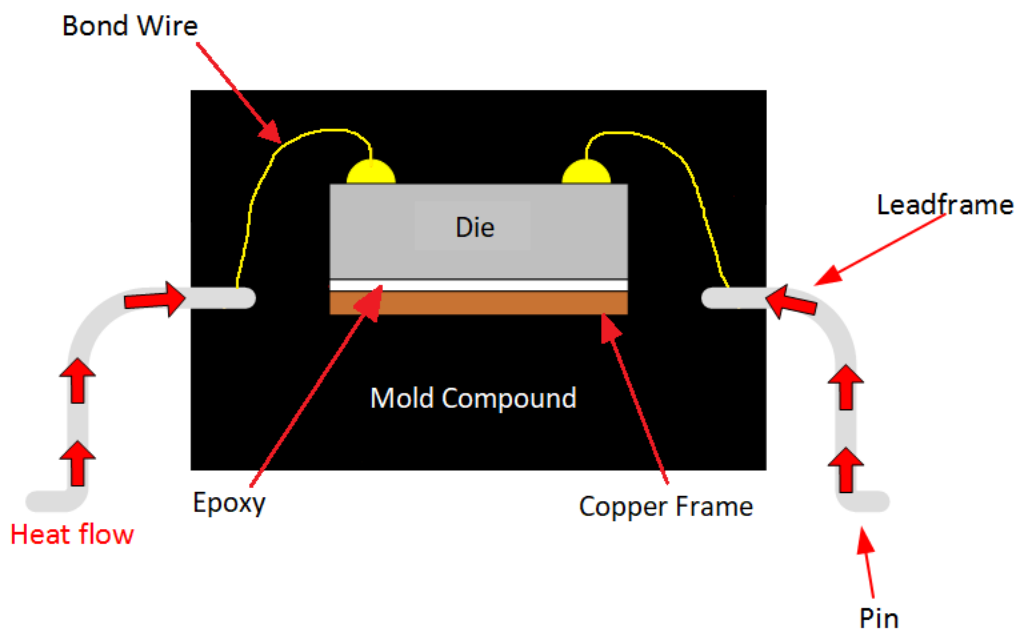

Figure 8. Heat Transfer SOT23 (LM71A[DBV]) Package Cross Section

1.3 Determining Thermal Conduction Through The PCB

Power hungry components can generate a significant amount of heat during operation, and a PCB designer needs to have an understanding of how heat is conducted by the PCB. The layout of the PCB affects the thermal conductivity and thus the temperature measurement. Understanding the total thermal resistance of the PCB will help the PCB designer to determine whether it is necessary to use filled or plated vias, use thicker copper plating or add additional copper layers to disperse heat quicker.

1.3.1 General Thermal Conduction Equation

Thermal resistance can be expressed by the following equation:

$$\theta = \frac{L}{k \times A_{CS}}$$

where

- θ is the thermal resistance [K/W]
 - k is the thermal conductivity factor [W/(m*K)]
 - L is the thermal path length [m]
 - A_{CS} is the cross sectional area in which heat is applied [m²]
- (2)

To calculate the thermal conduction through the PCB, the individual paths can be broken down and analyzed separately. The main components are the thermal conduction through the PCB (see [Section 1.3.4](#) and [Section 1.3.2](#)), and the conduction through the via (see [Section 1.3.5](#)). The most common materials in many PCB applications are FR4, copper, and soldermask materials. By applying [Equation 2](#) to the perpendicular path for the appropriate PCB materials, the longitudinal path, and the thermal flow through the vias individually, thermal conduction through the PCB can be modeled accurately.

1.3.2 Longitudinal Thermal Conduction

[Figure 9](#) shows the longitudinal conduction path of a PCB with the direction of the heat flow from the heat source along the FR4.

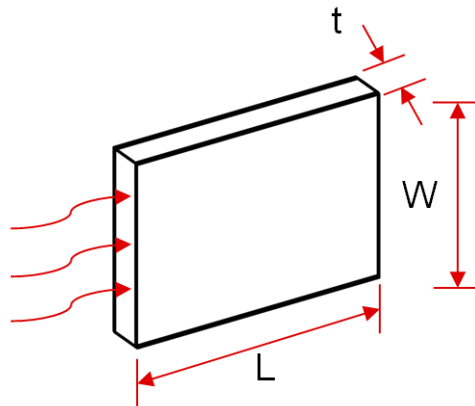

Figure 9. Longitudinal Conduction Heat Flow

[Figure 9](#) applies the general thermal conduction equation to a cuboid.

$$\theta = \frac{L}{k \times A_{CS}} = \frac{L}{k \times W \times t}$$

where

- L is the path length of heat flow
 - W is the width and t is the thickness
 - $W \times t = A_{CS}$ is the cross sectional area where the heat is being applied
 - $L = W$ for square
- (3)

1.3.3 Example: Determining The Dominant Longitudinal Thermal Conduction Path

Applying Equation 3 to a 1.6mm thick layer of FR4 of square dimensions (1m x 1m) results in a thermal resistance of 2,500°C/W, as shown in Equation 4

$$\theta_{FR4} = \frac{L}{k \times W \times t} = \frac{1\text{m}}{0.25 \frac{\text{W}}{\text{m} \times ^\circ\text{C}} \times 1\text{m} \times 2 \times 1.6 \times 10^{-3}\text{m}} = 2500^\circ\text{C/W} \quad (4)$$

Two 1oz (35µm) copper planes of the same PCB would have the thermal resistance of 3,710°C/W, as calculated in Equation 5

$$\theta_{Cu} = \frac{L}{k \times W \times t} = \frac{1\text{m}}{385 \frac{\text{W}}{\text{m} \times ^\circ\text{C}} \times 1\text{m} \times 2 \times 35 \times 10^{-6}\text{m}} = 3710^\circ\text{C/W} \quad (5)$$

While thickness of the copper plane is significantly thinner than the thickness of the FR4 layer, the ability to transfer heat is in the same order of magnitude. This is because the thermal conductivity of copper is approximately 1,500 times larger than the thermal conductivity of FR4. It can be seen that the copper planes of the above example PCB transfer heat slightly slower than the significantly thicker FR4 layer.

In the longitudinal direction, several layers of the PCB need to be considered in parallel. Compared to a PCB without copper floods, it is possible to almost double the heat transfer rate along the plane by adding two 1oz layers of copper floods.

Because the different layers transfer heat in parallel, the effective total thermal resistance of the cross-section is 1,494°C/W, as calculated in Equation 6

$$\theta_{\text{total}} = \theta_{Cu} \parallel \theta_{FR4} = \frac{\theta_{Cu} \times \theta_{FR4}}{\theta_{Cu} + \theta_{FR4}} = \frac{3710 \times 2500}{3710 + 2500} = 1494^\circ\text{C/W} \quad (6)$$

1.3.4 Perpendicular Thermal Conduction

Figure 10 shows the perpendicular conduction heat flow of a PCB.

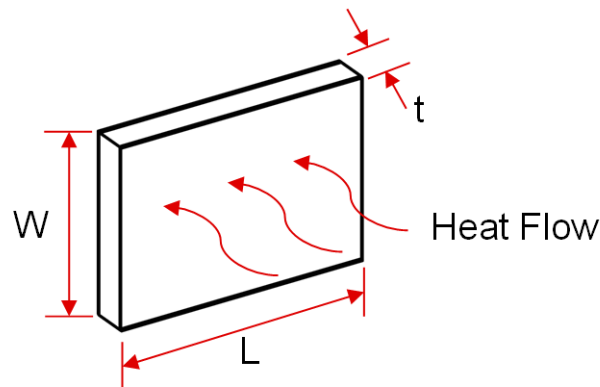

Figure 10. Perpendicular Conduction Heat Flow

Equation 7 is the perpendicular conduction heat flow equation to determine the thermal resistance of a material, as specified in Table 1.

$$\theta = \frac{t}{k \times A_{CS}} = \frac{t}{k \times W \times L}$$

where

- t is the path of heat flow (the heat flows through the thickness of the material) [m]
 - $W \times L = A_{CS}$ is the cross sectional area where the heat is being applied [m²]
- (7)

1.3.5 Thermal Conduction Through A Via

Calculating the thermal conduction path of a via (as shown in Figure 11) can be useful to determine if a regular via suffices, a larger size or quantity of vias is required, or if vias need to be filled with a conductive fill. A conductive fill transfers heat faster to the opposite side of the board, but also increases PCB manufacturing cost.

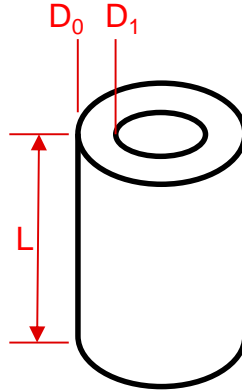

Figure 11. Conduction Through Via

Equation 8 applies the general thermal conduction equation to a via.

$$\theta = \frac{L}{k \times A_{CS}} = \frac{L}{k \times \pi \times \left(\left(\frac{D_0}{2} \right)^2 - \left(\frac{D_1}{2} \right)^2 \right)}$$

where

- L is the length of the via (the heat flows through the length of the cylinder) [m]
- D₀ is the outer via diameter [m]
- D₁ is the inner via diameter [m]

(8)

1.3.6 Example: Determining The Dominant Perpendicular Thermal Conduction Path

In the perpendicular direction, a PCB designer may want to compare the thermal resistance of a via with the equivalent thermal resistance of FR4 to determine if placing additional vias is a useful technique in transferring heat quickly from one side of the PCB to the other.

The sidewalls of a non-tented, non-filled via with a 0.5mm drill hole size, a sidewall copper thickness of 35µm, and a length of 1.6mm have the thermal resistance of 81°C/W, as shown in Equation 9. Note that the sidewall thickness of a via is often different from the copper plating thickness and depends on via dimensions and the manufacturing process of the PCB manufacturer.

$$\theta_{Cu} = \frac{L}{k \times A_{CS}} = \frac{L}{k \times \pi \times \left(\left(\frac{D_0}{2} \right)^2 - \left(\frac{D_1}{2} \right)^2 \right)} = \frac{1.6 \times 10^{-3}}{385 \frac{W}{m \times ^\circ C} \times \pi \times \left(\left(\frac{0.5 \times 10^{-3}}{2} \right)^2 - \left(\frac{0.43 \times 10^{-3}}{2} \right)^2 \right)} = 81^\circ C/W$$

(9)

In order to obtain an accurate result, the thermal resistance of the air cylinder inside the via also needs to be calculated and considered in parallel with the thermal resistance of the via sidewalls.

$$\theta_{Cu} = \frac{L}{k \times A_{CS}} = \frac{L}{k \times \pi \times \left(\left(\frac{D_0}{2} \right)^2 - \left(\frac{D_1}{2} \right)^2 \right)} = \frac{1.6 \times 10^{-3}}{385 \frac{W}{m \times ^\circ C} \times \pi \times \left(\left(\frac{0.43 \times 10^{-3}}{2} \right)^2 - \left(\frac{0}{2} \right)^2 \right)} = 400646^\circ C/W$$

(10)

Equation 10 shows that the thermal resistance of the air cylinder is greater than 400,000°C/W. Because it is approximately 5,000 times as large as the thermal resistance of the via sidewalls, the thermal conduction contribution of the air has a negligible effect and can be ignored, as is proven by Equation 11.

$$\theta_{\text{via}} = \theta_{\text{Cu}} \parallel \theta_{\text{air}} = \frac{\theta_{\text{Cu}} \times \theta_{\text{air}}}{\theta_{\text{Cu}} + \theta_{\text{air}}} = \frac{81 \times 400646}{81 + 400646} = 81^\circ\text{C} / \text{W} \quad (11)$$

The air filled drill hole of a via does not contribute much to the heat transfer rate, so almost all of the heat transfer of a standard via occurs through its sidewalls. However, vias in which the hole is filled with a different material may benefit from the heat transfer contribution of that material. Some designs require vias to be filled in order to transfer heat even faster than a normal via. Filled vias should be considered if even multiple parallel standard vias do not provide a sufficiently fast heat transfer rate to meet system specifications.

The thermal resistance of 81°C/W for the non-filled via from this example can be compared to the thermal resistance of a solid FR4 cylinder of equal outer diameter to determine how much more effective a copper via is in transferring heat from one side of the PCB to the other. Equation 12 shows that the thermal resistance of an equivalently sized cylinder of FR4 is 32,595°C/W, which is approximately 400 times more resistive than the thermal resistance of the via.

$$\theta_{\text{FR4}} = \frac{L}{k \times A_{\text{CS}}} = \frac{L}{k \times \pi \times \left(\left(\frac{D_0}{2} \right)^2 - \left(\frac{D_1}{2} \right)^2 \right)} = \frac{1.6 \times 10^{-3}}{0.25 \frac{\text{W}}{\text{m} \times ^\circ\text{C}} \times \pi \times \left(\left(\frac{0.5 \times 10^{-3}}{2} \right)^2 - \left(\frac{0}{2} \right)^2 \right)} = 32595^\circ\text{C/W} \quad (12)$$

An air filled drill hole contributes negligible thermal transfer. However, because the thermal conductivity of copper is approximately 1,500 higher than FR4, the via of above dimensions is able to transfer heat to the opposite side of the PCB through the via sidewalls approximately 400 times faster than an FR4 cylinder of the same outer diameter. Therefore, placing multiple parallel non-filled vias can be a very effective method to transfer heat quickly from one side of the PCB to the other within a localized area.

2 Design Guidelines For Air Temperature Measurement

For some applications, it is desirable to design for a low thermal conductivity between the PCB and the temperature sensors. This is desired when the ambient air temperature is to be measured, rather than the temperature of the PCB or nearby components.

Examples of such applications include

- Thermostat ambient air temperature measurement
- Indoor and outdoor weather stations
- Wireless sensor node

In such systems, slow changes in air temperature are of interest, while heat sources such as a the heat of a nearby processor would result in an inaccurate reading. The guidelines in sections [Section 2.1](#) to [Section 2.6](#) docato-extra-info-title Edge connector [Section 2.5](#).

2.1 Ground Plane Considerations

Due to the higher thermal conductivity of copper, running solid ground planes between other ICs and the sensor will cause undesired heat transfer which should be avoided. It is best to avoid copper planes near the temperature sensor that are connected to the copper planes of other ICs, as shown in [Figure 12](#)

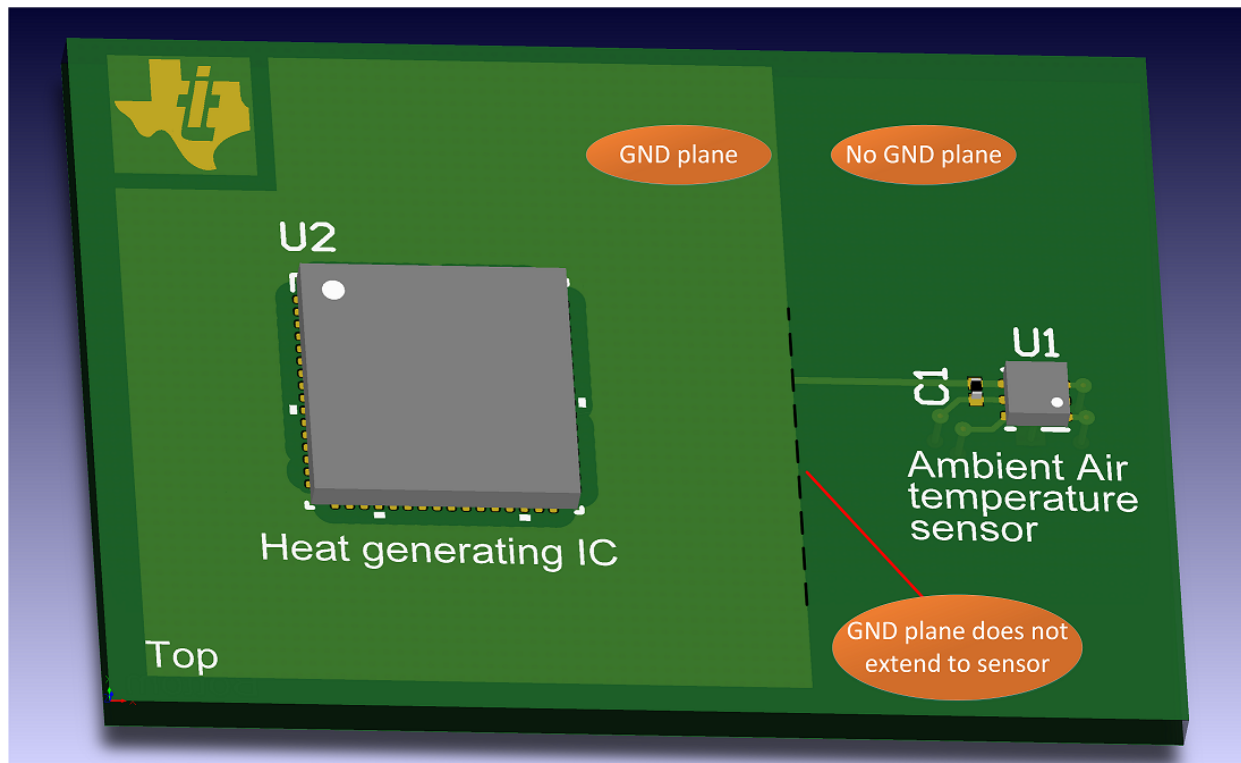

Figure 12. GND Plane Does Not Extend To Temperature Sensor (Top View)

For even better results, create a separate a small copper plane on both sides of the sensor as shown in [Figure 13](#) and [Figure 14](#) , and add several vias to thermally link the top and bottom planes together. Because of the low thermal conductivity of the solder mask compared to copper (see [Table 1](#)), it is advised to create a solder mask cut-out around the copper plane. This will allow the sensor to respond to ambient air temperature measurements significantly faster than in systems in which the copper plane is coated by solder mask. Add a physical gap between the plane around the sensor and the planes of the rest of the PCB. Hatched GND planes in the main section of the PCB further reduce heat flow from other ICs to the sensor.

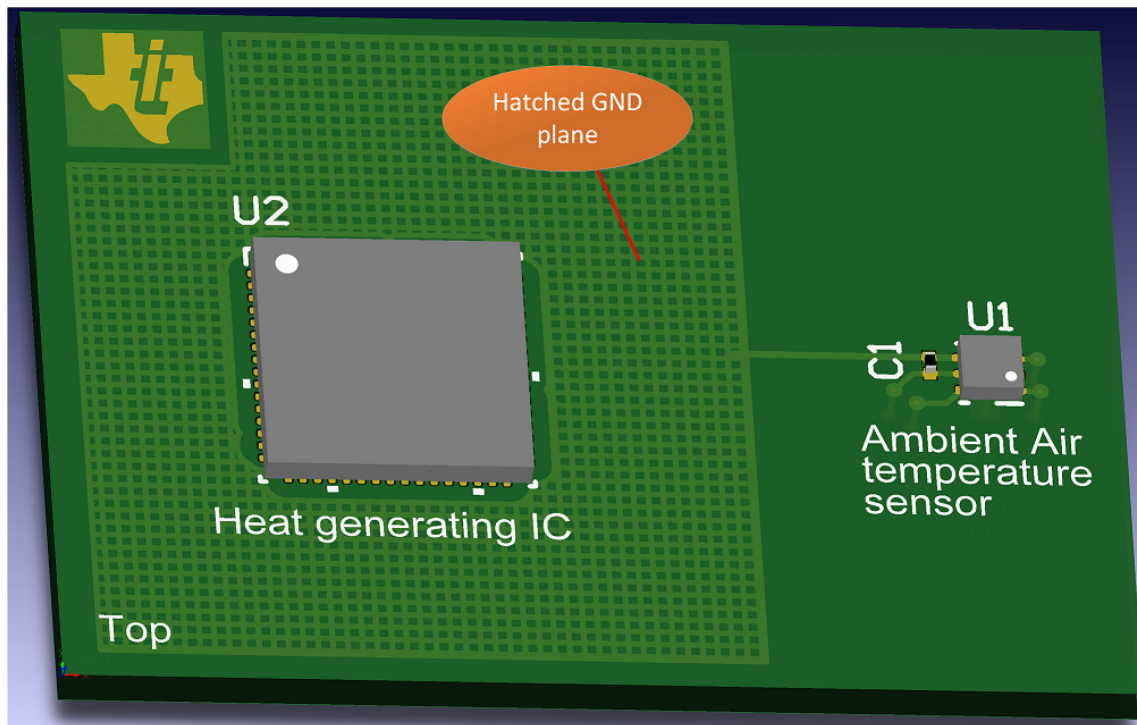

Figure 13. Hatched GND Plane (Top View)

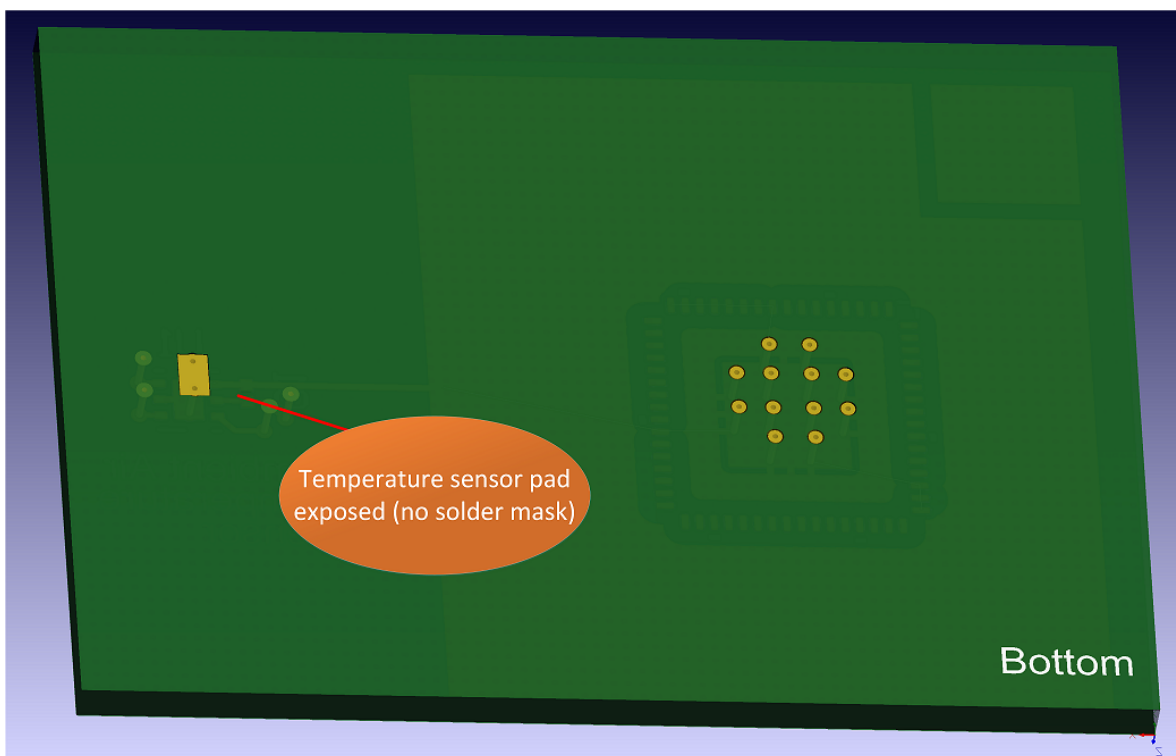

Figure 14. Exposed Sensor GND Pad (Bottom View)

2.2 Partitioning the PCB

The temperature sensor should be in an area of the PCB that is as far away from the main heat generating ICs, as shown in [Figure 15](#). This can be achieved by placing the sensor in a corner of the PCB, away from other components. Doing so will minimize the effect that other components on the board have on the temperature reading.

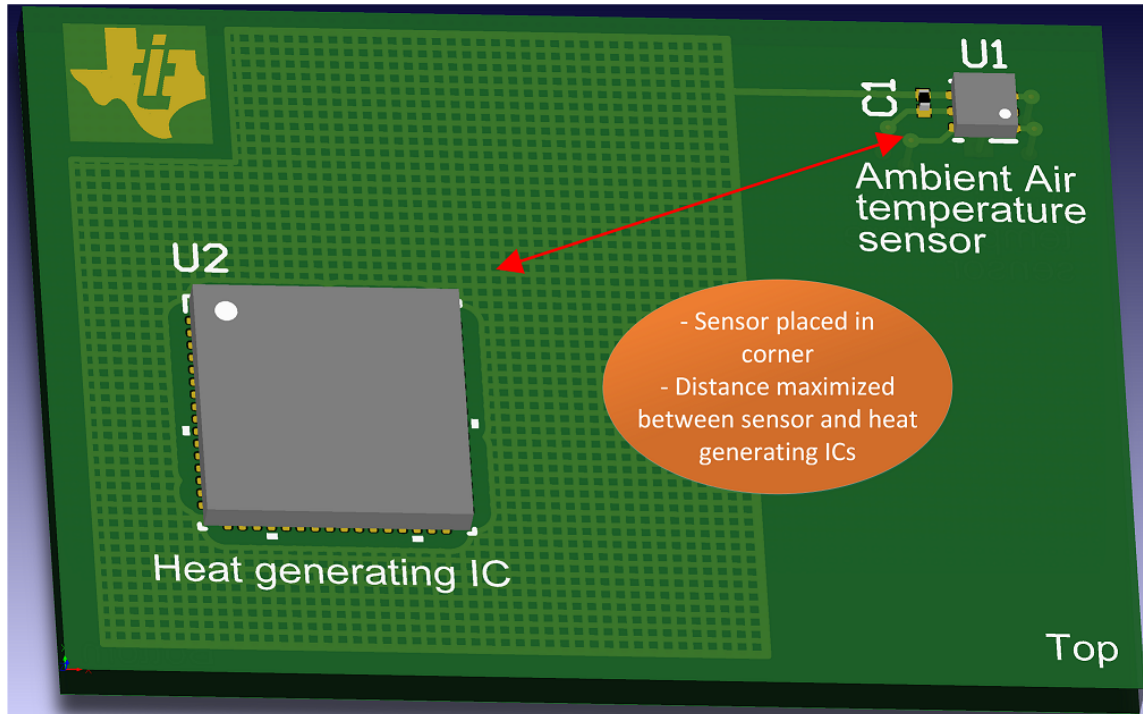

Figure 15. Sensor Placed In PCB Corner

2.3 Isolation Island

If feasible, a partial router trace around the temperature sensor creates an isolation island which greatly reduces heat transfer from the main heat source to the sensor. Heat transfer is reduced because the thermal conductivity of air compared is significantly lower than the thermal conductivity of FR4. An example of an isolation island is shown in [Figure 16](#).

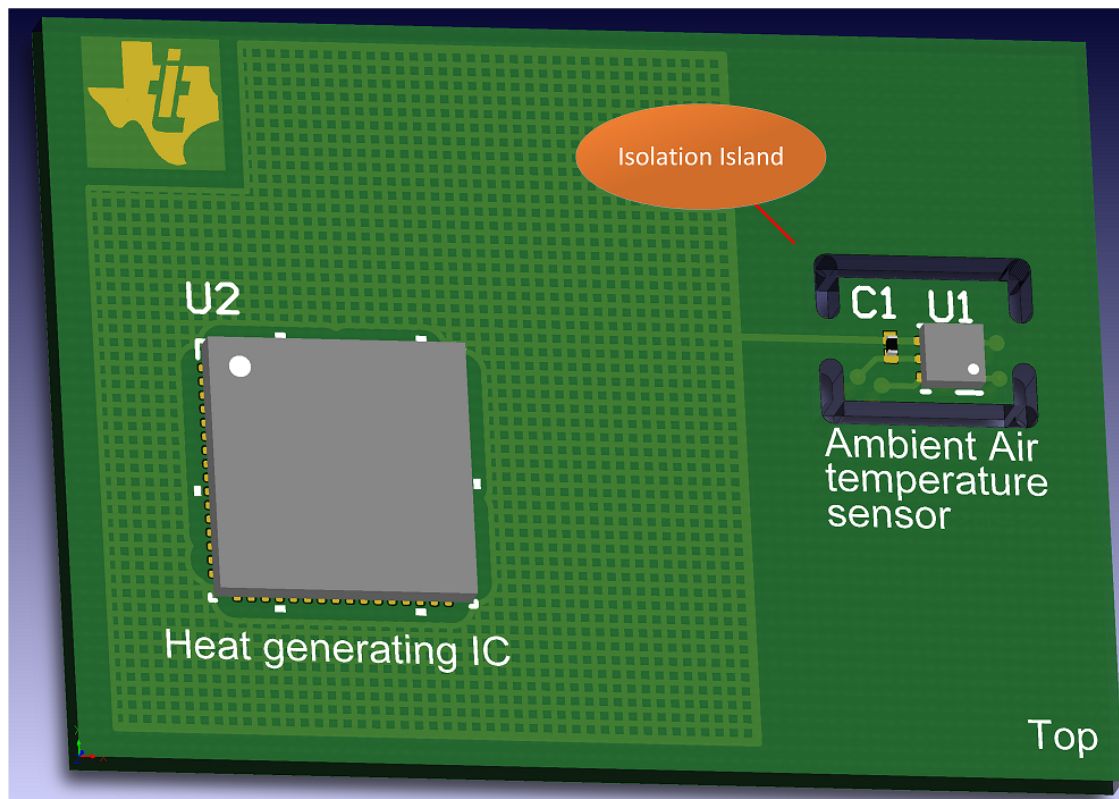

Figure 16. Isolation Island Significantly Reduces Heat Transfer From Main Heat Source To Temperature Sensor

2.4 Perforation

As an alternative to the isolation island discussed in [Section 2.3](#), it is possible to add a perforation around the section with the temperature sensor, as shown in [Figure 17](#). Doing so greatly minimizes the amount of heat transfer through the FR4 material. An example of a perforated PCB is the TMP116 Evaluation module.

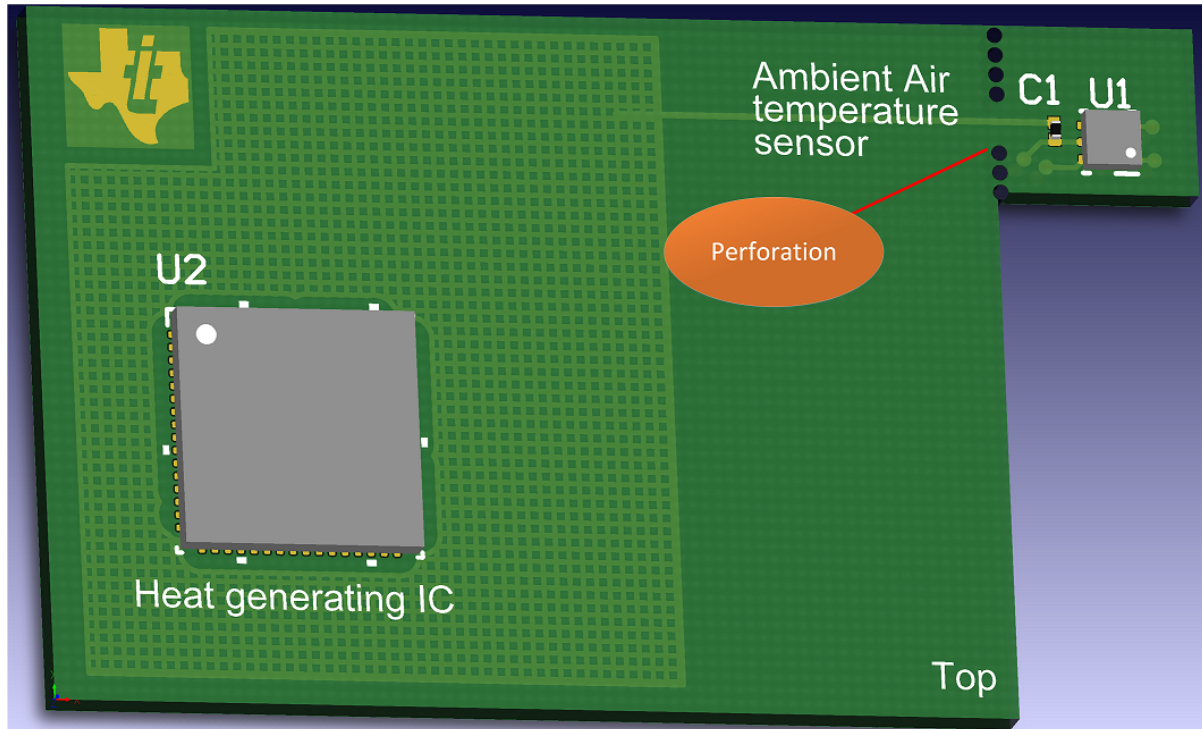

Figure 17. Perforation Reduces Heat Transfer From Heat Source To Temperature Sensor

2.5 Edge Connector

A miniature PCB that contains only the temperature sensor and is mounted using an edge connector to the main PCB is a highly effective method for avoiding significant heat transfer from the main PCB to the temperature sensor. The edge connector should ideally be mounted at a location away from major heat sources on the main PCB so that radiated heat from ICs does not interfere with the temperature reading. This technique is illustrated in [Figure 18](#)

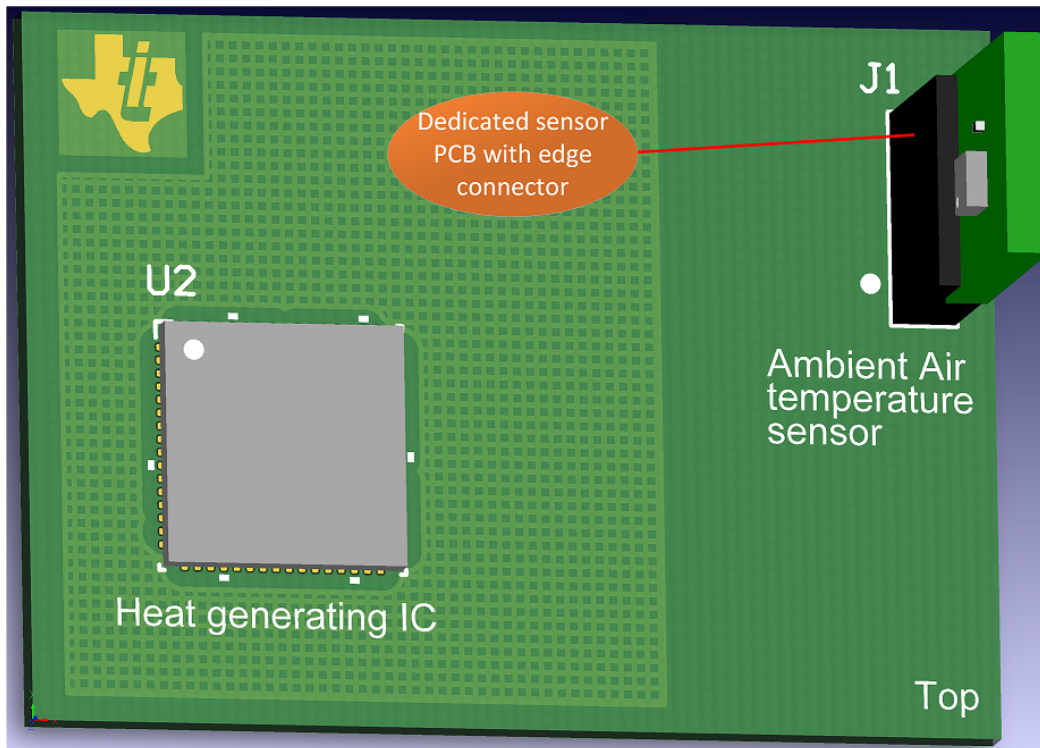

Figure 18. Dedicated Sensor PCB With Edge Connector

2.6 Controlling the Thermal Mass of the PCB

The thermal mass is a material's ability to store heat energy. A material with a high thermal mass will respond to temperature fluctuations more slowly than one with a lower thermal mass. To keep the thermal mass of the PCB as small as possible, it is advised to use a thin PCB (e.g. 0.8mm rather than the standard 1.6mm FR4 thickness), or even place the temperature sensor on a flex PCB as shown in Figure 19. When combined with either one of the techniques for reducing PCB surface area (see Section 2.3 and Section 2.4), a thin PCB can correspond to changes in air temperature much more rapidly than a large, thick PCB with a high thermal mass.

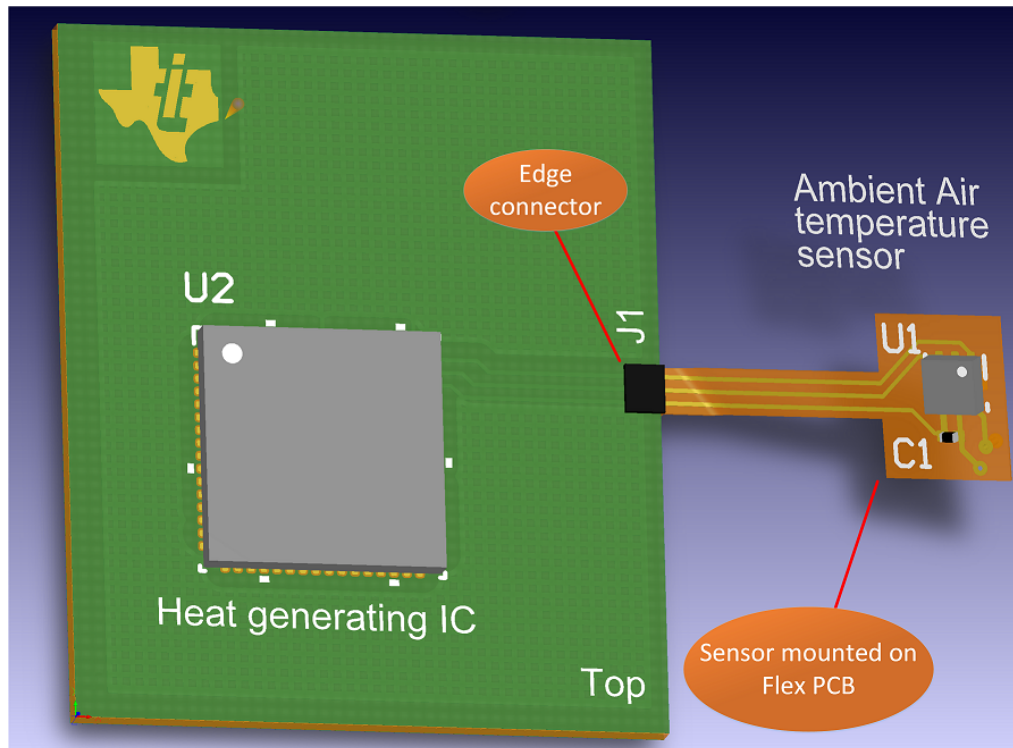

Figure 19. Dedicated Sensor Flex PCB With Edge Connector

3 Design Guidelines For Component Temperature Measurement

In many scenarios, system designers want to monitor the die temperature of a power hungry IC such as a MCU, GPU, ASIC, FPGA, DSP, or CPU in order to dynamically adjust its performance, control fan speed in the system, or initiate a safe system shutdown. Using a remote temperature sensor such as TMP46x, TMP43x or TMP411 is the preferred method for monitoring temperature of ICs as long as they have a suitable integrated temperature diode. Guidance on product selection for remote temperature sensors is available [here](#). Application note [Optimizing Remote Diode Temperature Sensor Design](#) contains details on compensation techniques and layout practices for remote temperature sensors.

If the IC does not contain a suitable temperature sense diode or if a remote sensor cannot be used for any other reason, then a local sensor or an external diode can be used instead. The following sections provide guidelines on obtaining the most accurate measurement and fastest response of a local sensor that monitors the temperature of another IC.

3.1 Location

The sensor location should be chosen to be as close as possible to the heat source that is to be monitored. Avoid any perforations or slits in the PCB between the IC and the temperature sensor, as they will reduce the thermal response.

3.1.1 Bottom-Side Mounting

If possible, mount the temperature monitor on the bottom side of the PCB, directly below the heat source, as shown in [Figure 20](#). As explained in [Section 1.3.5](#), vias are a highly effective method for transferring heat quickly from one side of the PCB to the other because of the superior thermal conductivity of copper compared to FR4. Therefore, using as many parallel vias as feasible or using filled conductive vias to transfer heat from the heat source to the temperature monitor creates a fast thermal equilibrium between the two ICs. A QFN or DFN package with a DAP further helps to decrease the thermal resistance path between the vias and the sensor die.

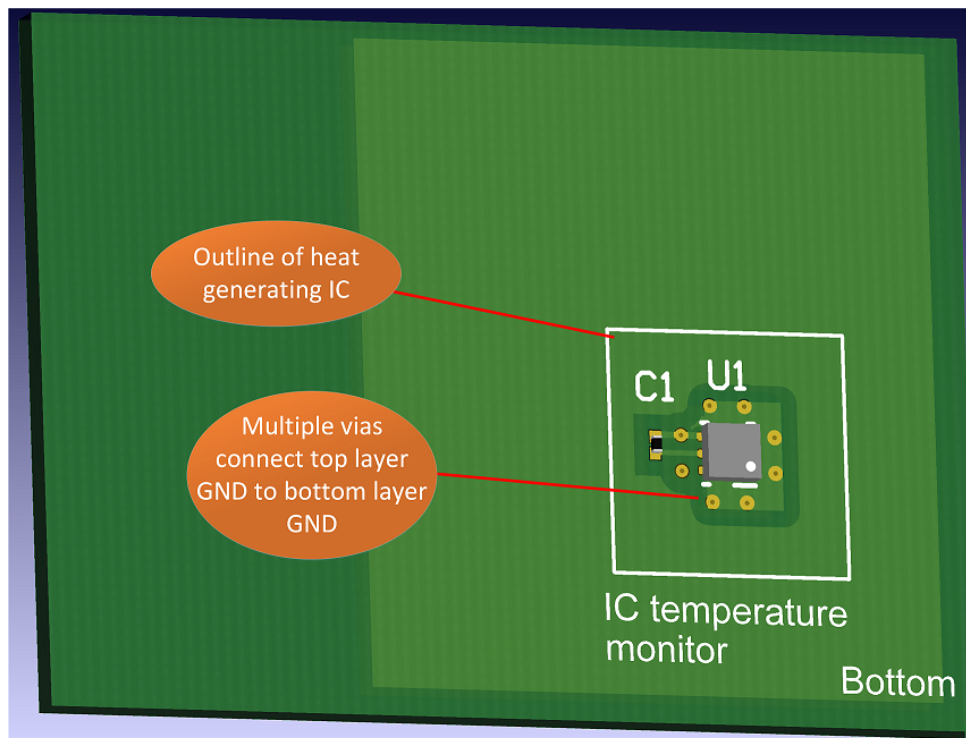

Figure 20. Sensor Mounted On Opposite Side Of Heat Source; Multiple Vias Ensure Fast Heat Transfer

3.1.2 Ground Plane Considerations

If it is not practical or cost effective to place the temperature sensor on the opposite side of the heat source, place it on the same side as close as possible to it, as shown in [Figure 21](#). The most effective way of creating a thermal equilibrium between the heat source and the temperature monitor is through the ground plane. Use a solid ground plane that extends from the heat source to the temperature sensor.

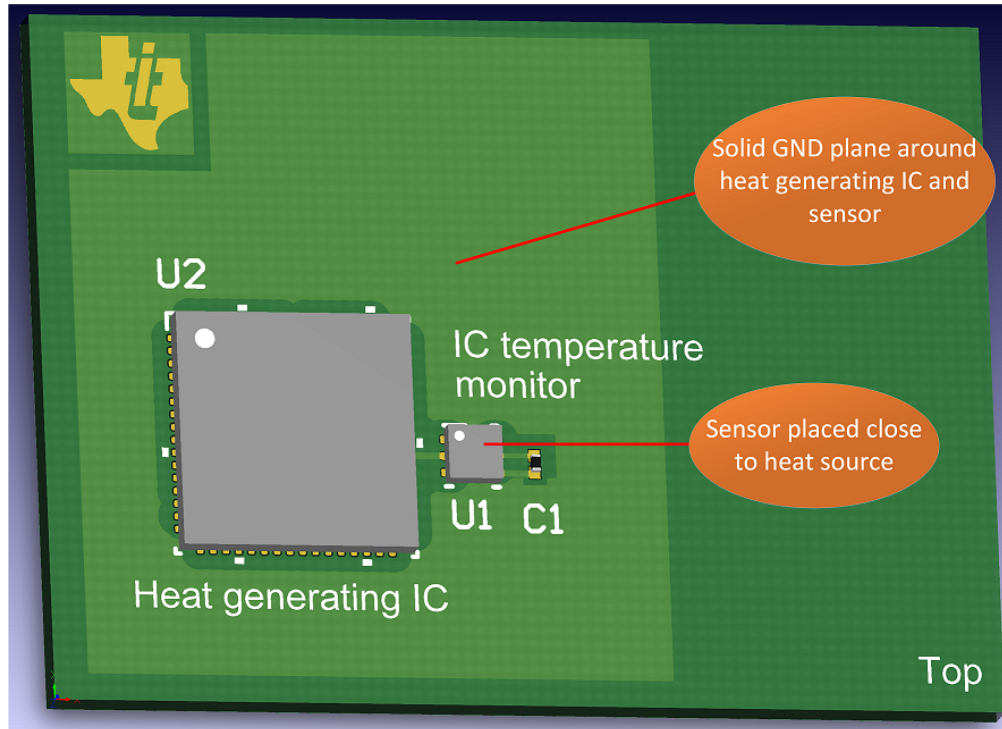

Figure 21. Shared GND Plane Helps With Thermal Equilibrium

4 Summary

When designing a PCB with a temperature sensor, the system designer needs to consider if the objective is to measure ambient air temperature or to monitor the temperature of a nearby power hungry IC. This application note discusses the background and layout techniques for both objectives. For ambient air temperature measurements, physical isolation between the sensor and heat generating components on the same PCB is critical. Additionally, consideration of thermally conductive paths such as GND planes play an important role to ensure that nearby components do not cause false ambient temperature readings. In contrast, measuring the die temperature of ICs requires careful consideration of sensor location and a path with high thermal conductivity to create a fast thermal equilibrium between the sensor and the heat generating IC.

Revision History

NOTE: Page numbers for previous revisions may differ from page numbers in the current version.

Changes from Original (July 2017) to A Revision	Page
• Corrected Figure 8	6
• Changed Equation 4	8
• Changed Equation 5	8
• Changed Equation 9	9
• Changed Equation 10	9
• Changed Equation 12	10

IMPORTANT NOTICE AND DISCLAIMER

TI PROVIDES TECHNICAL AND RELIABILITY DATA (INCLUDING DATASHEETS), DESIGN RESOURCES (INCLUDING REFERENCE DESIGNS), APPLICATION OR OTHER DESIGN ADVICE, WEB TOOLS, SAFETY INFORMATION, AND OTHER RESOURCES "AS IS" AND WITH ALL FAULTS, AND DISCLAIMS ALL WARRANTIES, EXPRESS AND IMPLIED, INCLUDING WITHOUT LIMITATION ANY IMPLIED WARRANTIES OF MERCHANTABILITY, FITNESS FOR A PARTICULAR PURPOSE OR NON-INFRINGEMENT OF THIRD PARTY INTELLECTUAL PROPERTY RIGHTS.

These resources are intended for skilled developers designing with TI products. You are solely responsible for (1) selecting the appropriate TI products for your application, (2) designing, validating and testing your application, and (3) ensuring your application meets applicable standards, and any other safety, security, or other requirements. These resources are subject to change without notice. TI grants you permission to use these resources only for development of an application that uses the TI products described in the resource. Other reproduction and display of these resources is prohibited. No license is granted to any other TI intellectual property right or to any third party intellectual property right. TI disclaims responsibility for, and you will fully indemnify TI and its representatives against, any claims, damages, costs, losses, and liabilities arising out of your use of these resources.

TI's products are provided subject to TI's Terms of Sale (www.ti.com/legal/termsofsale.html) or other applicable terms available either on ti.com or provided in conjunction with such TI products. TI's provision of these resources does not expand or otherwise alter TI's applicable warranties or warranty disclaimers for TI products.

Mailing Address: Texas Instruments, Post Office Box 655303, Dallas, Texas 75265
Copyright © 2019, Texas Instruments Incorporated