

TMS320C6748/46/42 and OMAP-L132/138 Universal Serial Bus Downstream Host Compliance Testing

Christina Lam
DSPS Applications

ABSTRACT

This application report describes the TMS320C6748/46/42 and OMAP-L132/138 embedded Host electrical compliance of a high-speed (HS) universal serial bus (USB) operation conforming to the USB 2.0 specification. The OTG controller supports the USB 2.0 device and host mode at high-speed (HS), full-speed (FS) and low-speed (LS).

Contents

1	Introduction	2
2	Test Items	3
3	Required Instruments	4
4	Test Condition	5
5	References	29

List of Figures

1	USB Functional Block Diagram	2
2	Equipment Setup for High-Speed Downstream Host Signal Quality Testing	6
3	Downstream Eye Diagram	7
4	Downstream Waveform Plot	8
5	Rise and Fall Time Patterns	8
6	Duty Cycle Distortion (DCD)	8
7	Random Jitter/Deterministic Jitter/Total Jitter	9
8	Equipment Setup for Downstream Host Packet Parameters Tests	9
9	Status Stage of a GET DEVICE DESCRIPTOR Transaction SYNC Field of the Token Packet.....	10
10	Inter-Packet-Gap Between the Data Packet of Device and Acknowledge Packet of the Embedded Host on the Data Stage of the GET DESCRIPTOR Command	11
11	Inter-Packet-Gap Between the Token Packet and the Data Packet of the Status Stage of the GET DESCRIPTOR Transaction	12
12	EOP Field of Non-SOP Packet of the Data Packet of the Status Stage of the GET DESCRIPTOR Command.....	13
13	EOP Field of an SOP Packet	14
14	Equipment Setup for Downstream Host Chirp and Suspend and Resume Timings	15
15	Downstream Chirp Response Time	16
16	Chirp-K and Chirp-J Duration	17
17	Time Between First SOF and Last Chirp-(J or K)	18
18	DUT Host Enters Suspend State	19
19	DUT Host Resumes	20
20	Equipment Setup for Downstream Test J/K, SEO_NAK	21
21	Equipment Setup for Full-Speed Downstream Host Signal Quality Testing	23
22	Waveform Plot	24
23	Full-Speed Eye Diagram	25

24	Equipment Setup for Low-Speed Downstream Host Signal Quality Testing	26
25	Low-Speed Waveform Plot.....	27
26	Low-Speed Eye Diagram	28

List of Tables

1	Host Electrical Tests Result Summary	3
2	Test Categories	3
3	Required Instruments.....	4
4	Power Supply Voltage and Temperature Condition	5
5	Test Packet Data.....	5
6	Overall Results of Signal Quality Test	6
7	Result Summary for Full-Speed Downstream Host Signal Quality	25
8	Result Summary for Low-Speed Downstream Host Signal Quality Test	29

1 Introduction

The C6748/46/42 and OMAP-L132/138 Host high-speed electrical test of the USB is performed on a verification and debug board (VDB), which is used to validate the device feature and is not optimized for USB characterization. Better results are expected when using test boards that are optimized for characterization purposes. These optimized boards follow the board design guidelines as recommended by the USB-IF.

The USB functional block diagram is shown in [Figure 1](#).

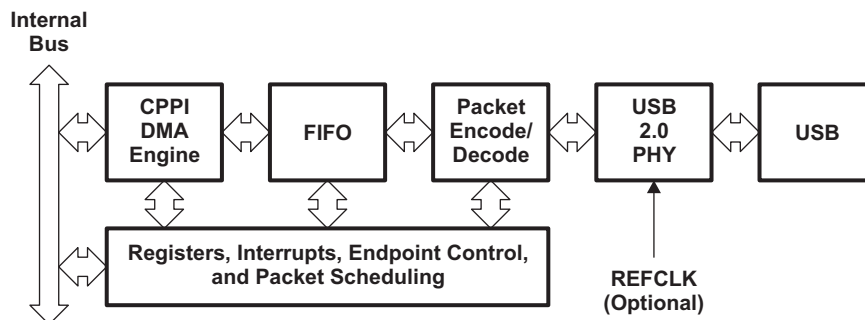

Figure 1. USB Functional Block Diagram

Code Composer Studio is a trademark of Texas Instruments.
 Windows is a registered trademark of Microsoft Corporation in the United States and/or other countries.
 Tektronix is a registered trademark of Tektronix, Inc.

2 Test Items

[Table 1](#) shows a summary of the test listings results of the compliance tests performed to evaluate the USB controller operation while operating in Host mode.

Table 1. Host Electrical Tests Result Summary

Test#	Test Items	Result
USB_EL_2	HS Host transmitter data rate 480 Mb/s \pm 0.05%	PASS
USB_EL_3	HS Host signal quality test measured at the near end	PASS
USB_EL_6	10% to 90% differential rise and fall time > 500 ps	PASS
USB_EL_7	Monotonic data transitions over the vertical openings in the appropriate EYE pattern template	PASS
USB_EL_21	SYNC field (packet originating from Host)	PASS
USB_EL_22	Inter-packet gap field (device and Host)	PASS
USB_EL_23	Inter-packet gap field (back-to-back Host)	PASS
USB_EL_25	EOP field (non-SOF packets)	PASS
USB_EL_55	EOP field (SOF packets)	PASS
USB_EL_33	Chirp response time	PASS
USB_EL_29	Chirp-K and chirp-J duration	PASS
USB_EL_31	Time between SOF and last chirp-(JorK)	PASS
USB_EL_39	Host suspend capability/timing	PASS
USB_EL_41	Host resume capability/timing	PASS
USB_EL_8	Test J/K (controller transmits continuous J)	PASS
USB_EL_8	Test K (controller transmits continuous K)	PASS
USB_EL_9	Test_SE0 (controller does not drive data lines)	PASS
-----	Legacy compliance (full-speed signal quality)	PASS
-----	Legacy compliance (low-speed signal quality)	PASS

The tests are classified into six categories (see [Table 2](#)). These categories correspond to the electrical test in the USB2.0 compliance test.

Table 2. Test Categories

Test Items	Categories
HS Host transmitter data rate 480 Mb/s \pm 0.05%	HS downstream signal quality test
HS Host signal quality test measured at the near end	
10% to 90% differential rise and fall time > 500ps	
Monotonic data transitions over the vertical openings in the appropriate EYE pattern template	Host packet parameters
SYNC field (packet originating from Host)	
Inter-packet gap field (device and Host)	
Inter-packet gap field (back-to-back Host)	
EOP field (non-SOF packets)	Host chirp timing
EOP field (SOF packets)	
Chirp response time	Host suspend/resume timing
Chirp-K and chirp-J duration	
Time between SOF and last chirp-(JorK)	
Host suspend capability/timing	Host test_J/K/SE0
Host resume capability/timing	
Test J (controller transmits continuous J)	
Test K (controller transmits continuous K)	
Test_SE0 (Host stops driving data lines)	Legacy USB compliance testing
Full-speed signal quality	

Table 2. Test Categories (continued)

Test Items	Categories
Low-speed signal quality	

3 Required Instruments

This section discusses the required instruments used for performing compliance tests. USB characterization tests are performed using test fixtures produced by Tektronix®.

NOTE: It is recommended that you use a scope with a 2 GHz bandwidth for performing the tests. This will not allow noise magnification to disturb the test. The DSA71604 is a very fast scope with a maximum operating bandwidth of 16 GHz. Even though the bandwidth needed is user selectable, during the time this test was performed, the TDSUSB2 software re-configures the user set bandwidth to the default 16 GHz speed configuration, disrupting the user settings. This is more important when performing low-speed signal quality testing since the test result captures differ heavily with a low bandwidth configuration yielding a much better result.

The high-speed electrical test (HSET) is not applicable for use with this solution since it requires an EHCI USB controller with Windows® XP/2000 running on the device. The C6748/46/42 and OMAP-L132/138 USB controller is not an EHCI controller, nor is it not running the required operating system (O/S). For this reason, you are required to create a similar application to the HSET utility furnished by the USB-IF. This utility should put the USB controller into the required test modes or configure the USB controller to perform transfers to create the right test conditions applicable for the test. The method used to invoke these tests is a Host test program running under Code Composer Studio™ software with test options controlled by variables where you select the desired test by modifying the variables within the watch window.

Table 3. Required Instruments

Type	Manufacturer	Product	Use
Oscilloscope	Tektronix	DSA71604	To measure USB signals
Differential probe (1)	Tektronix	P7313	Signal quality/receiver sensitivity tests
Single ended FET probe (2)	Tektronix	P6243	Packet parameters/Chirp timings
Measurement application (USB test software that is part of the scope application)	Tektronix	TDSUSB	USB compliance test software specifically used for USB
Test fixture	Tektronix	TDSUSBF	For USB test
Power Supply	Agilent	E3633A	5 V power supply for TDSUSBF
Digital multimeter	Fluke	Fluke 45 Series	Actual voltage monitor
Test board (VDB) ⁽¹⁾	TI	EVM like board	Non-optimized test board used for C6748/46/42 and OMAP-L132/138 device validation
Four self powered USB certified high-speed hubs	Digitus	Hub Twister	For full-speed signal quality testing
One self powered USB certified full-speed hub	ABB	-	For full-speed signal quality testing
One known good USB 2.0 certified compliant device	-	-	For high-speed testing
One known good USB 1.1 certified complaint device	-	-	For full-speed signal quality testing
One USB mouse	-	-	For low-speed signal quality test
Six 5 meter USB cables	-	-	For full-speed signal quality testing

⁽¹⁾ Results could change for the better if using an optimized test board.

4 Test Condition

4.1 Power Supply Voltage/Temperature

Table 4 shows the power supply voltage and temperature conditions:

Table 4. Power Supply Voltage and Temperature Condition

Parameter	Min	Typ	Max	Unit
USB_VDDA1P2LDO	1.14	1.2	1.26	V
USB_VDDA3P3	3.1	3.3	3.5	V
Operating Temperature	-10	25	95	°C

4.2 HS Downstream Signal Quality Test

The HS downstream signal quality test uses the *TEST_PACKET* to place the C6748/46/42 and OMAP-L132/138 USB controller in a test mode where the controller continuously transmits a fixed defined format test packet, which is defined in the USB 2.0 specification, Section 7.1.20. Even though there are many ways to achieve this task, the method used here is for the C6748/46/42 and OMAP-L132/138 to enumerate a known good device (a HS USB Flash drive); at the end of enumeration, you will force the device to go into *TEST_PACKET* test mode via the Code Composer Studio watch window. When this test mode is entered, the device continually transmits the data packet shown in Table 5.

The oscilloscope, along the embedded TDSUSB2 software, automatically analyzes the test packet signal quality as observed on the USB bus. For detailed procedures on how to configure the scope as well as the TDSUSB2 software, see the *Host High-Speed Electrical Test Procedure* documentation issued by the USB Implementers Forum (<http://www.usb.org/home>).

Table 5. Test Packet Data

Data Used for Generating Test Packet	
	00 00 00 00 00 00 00 00
	00 AA AA AA AA AA AA AA
	AA EE EE EE EE EE EE EE
	EE FE FF FF FF FF FF FF
	FF FF FF FF FF 7F BF DF
	EF F7 FB FD FC 7E BF DF
	EF F7 FB FD 7E

Figure 2 displays the equipment setup for high-speed downstream signal quality test.

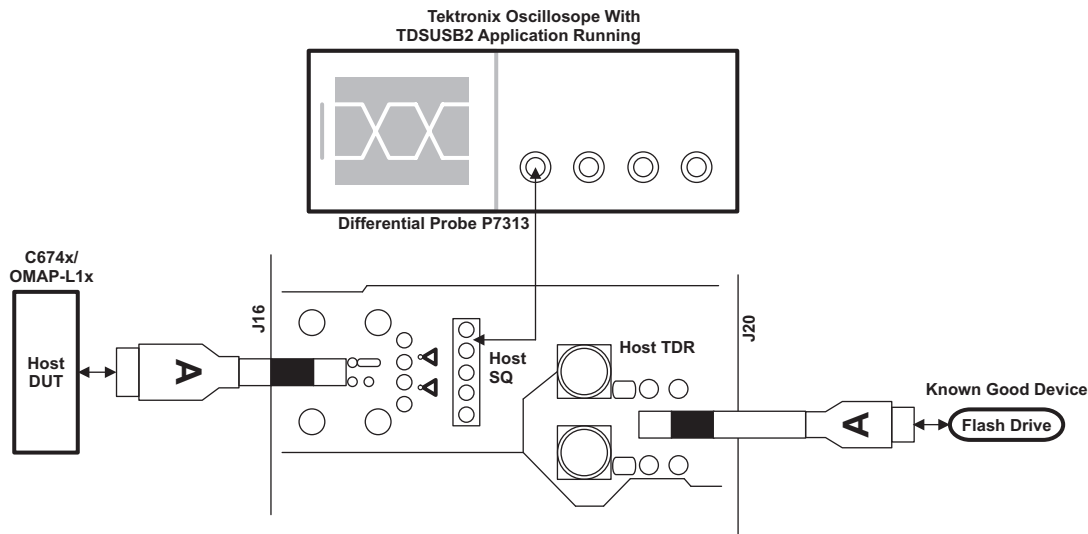

Figure 2. Equipment Setup for High-Speed Downstream Host Signal Quality Testing

4.2.1 EL_2: Signal Rate

A USB 2.0 high-speed transmitter data rate must be 480 Mb/s \pm 0.05%.

4.2.2 EL_3: Signal Quality/Eye Diagram Test

An eye diagram provides an intuitive view of jitter. It is a composite view of all the bit periods of a captured waveform superimposed upon each other. The USB 2.0 downstream port on a device, without a captive cable, must meet template 1 transform waveform requirements measured at a test point close to the port.

4.2.3 EL_6: Rise and Fall Time

A USB 2.0 high-speed driver must have 10% to 90% differential rise and fall times of greater than 500 ps.

4.2.4 EL_7: Monotonic Data Transitions

A USB 2.0 driver must have monotonic data transitions over the vertical openings specified in the appropriate EYE pattern template. These results were based on USB-IF/waiver limits.

Table 6. Overall Results of Signal Quality Test ⁽¹⁾

Measurement Name	Minimum	Maximum	Mean	pk-pk	Standard Deviation	RMS	Pop.	Status
Eye diagram test	-	-	-	-	-	-	-	Pass
Signal rate	463.3401 Mbps	490.3978 Mbps	479.9856 Mbps	0.0000 bps	4.264585 Mbps	479.9017 Mbps	512	Pass
EOP width	-	-	16.65205 ns	-	-	-	1	Pass
EOP width (bits)	-	-	7.992744	-	-	-	1	Pass
Falling Edge Rate	782.6515 V/ μ s	932.6815 V/ μ s	855.6221 V/ μ s	150.0300 V/ μ s	32.19147 V/ μ s	856.2218 V/ μ s	107	Pass
Rising Edge Rate	758.9723 V/ μ s	948.5002 V/ μ s	862.5047 V/ μ s	189.5279 V/ μ s	29.96392 V/ μ s	863.0202 V/ μ s	108	Pass

⁽¹⁾ Additional Information:

- Consecutive jitter range: -54.71 ps to 61.89 ps RMS jitter 23.96 ps
- KJ paired jitter range: -74.18 ps to 65.95 ps RMS jitter 22.08 ps
- JK paired jitter range: -41.40 ps to 56.57 ps RMS jitter 20.25 ps

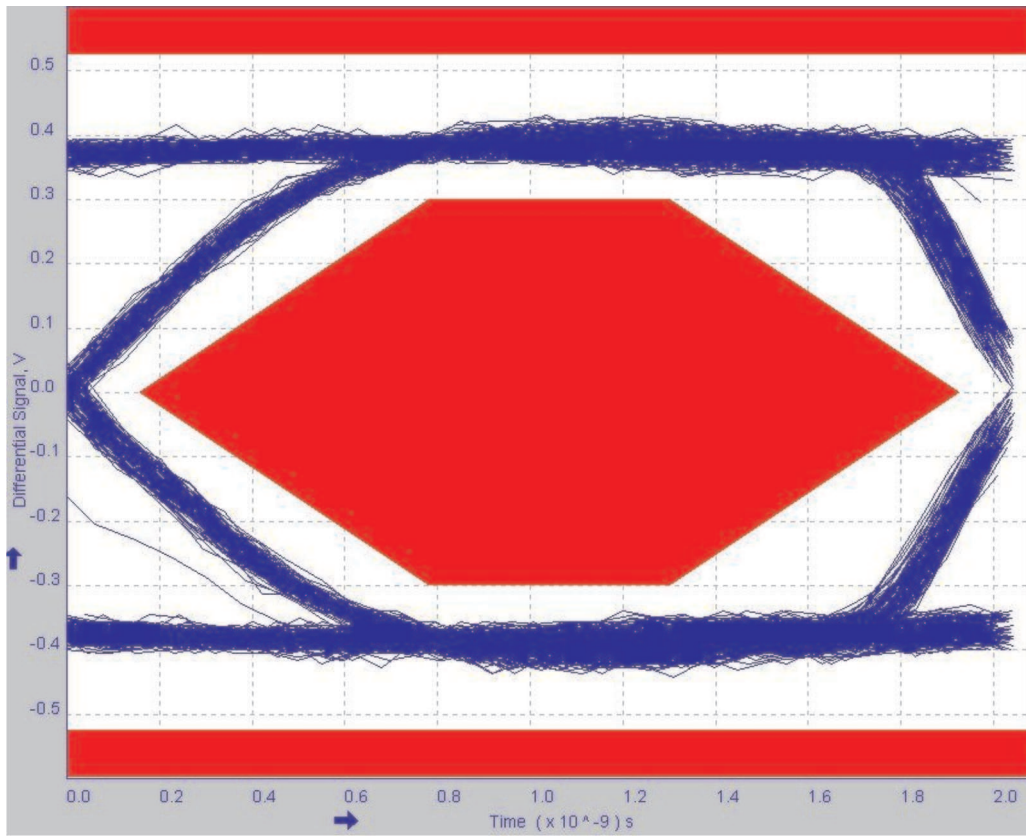

Figure 3. Downstream Eye Diagram

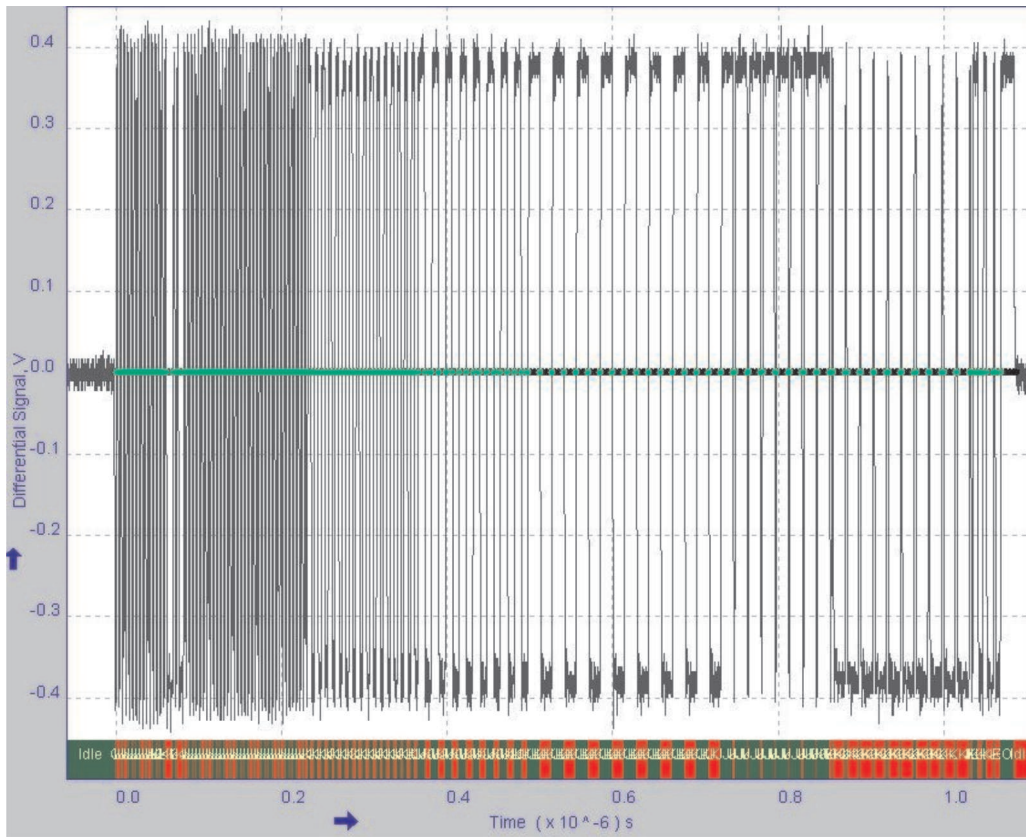

Figure 4. Downstream Waveform Plot

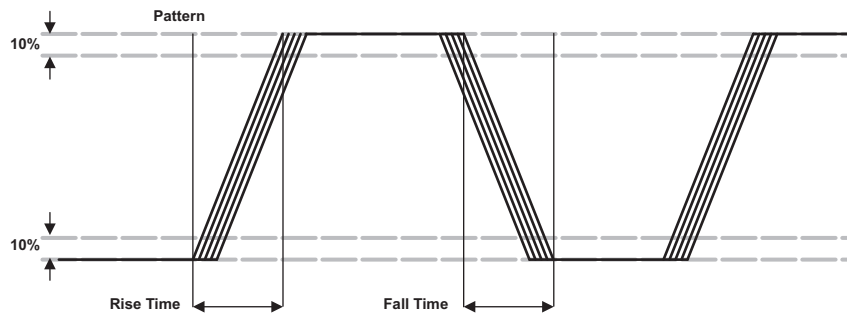

Figure 5. Rise and Fall Time Patterns

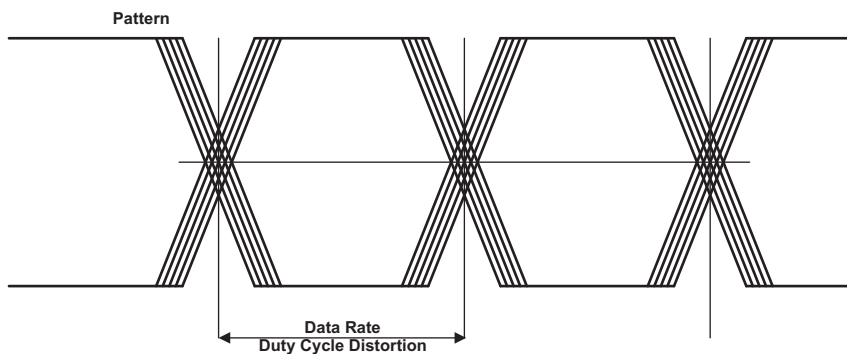

Figure 6. Duty Cycle Distortion (DCD)

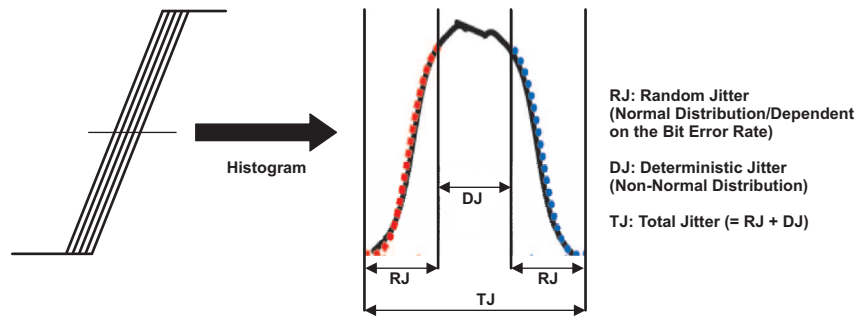

Figure 7. Random Jitter/Deterministic Jitter/Total Jitter

4.3 Host Packet Parameters

The Host packet parameter tests are comprised of a set of tests that pertains to the fields/elements of USB packets. Unlike the signal quality test, the Host controller does not need to enter into a test mode. A single step GET DEVICE DESCRIPTOR control transfer is invoked from the C6748/46/42 and OMAP-L132/138 DUT Host by pausing in between transactions to an attached known good high-speed device (Flash drive was used on this setup). The downstream host high-speed packet parameter test requires the use of the three stages of the GET DEVICE DESCRIPTOR command: setup, data, and status. The C6748/46/42 and OMAP-L132/138 DUT Host invokes the setup stage of the transaction and pauses until it is told to continue. For a GET DEVICE DESCRIPTOR command, it would be good to measure the Host packet parameters tests from either the setup stage or the status stage of the transaction since both of these stages comprises of the token and data packets originating from the Host. The packet delimiter fields, SYNC, EOP fields, and inter-packet delay are measured from either the setup stage or the status stage of the transaction.

Figure 8 displays the equipment setup for the high-speed downstream Host packet parameter tests.

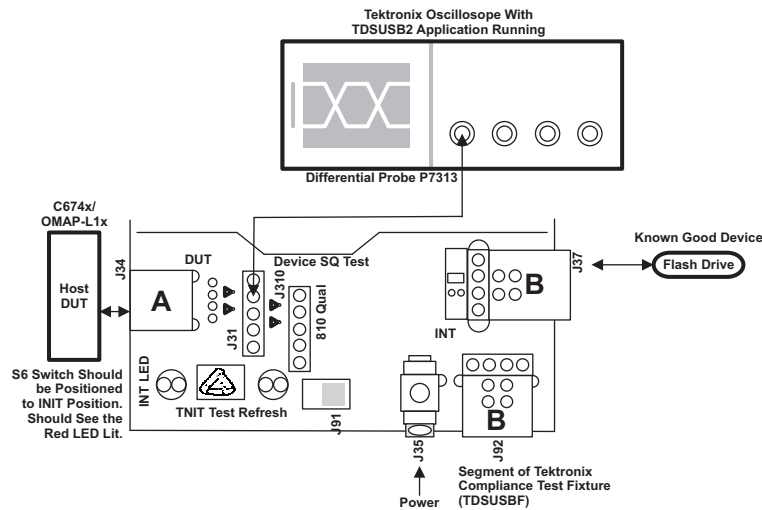

Figure 8. Equipment Setup for Downstream Host Packet Parameters Tests

4.3.1 EL_21: Synchronization (SYNC) Field

The SYNC field for all transmitted packets (not repeated packets) must begin with a 32-bit SYNC field.

Figure 9 displays the status stage of the GET DESCRIPTOR command with the SYNC field of the token packet zoomed.

Handshake packet SYNC field: PASS

NOTE: Measured value: 66.2 ns => 66.2 ns x 480 Mbps = 31.776 bits.

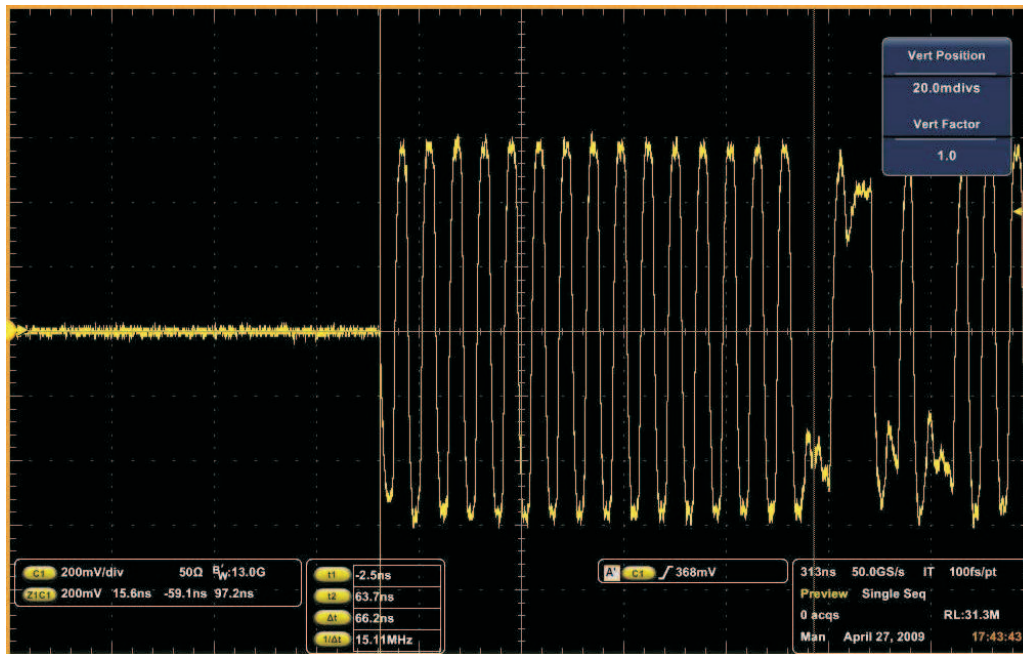

Figure 9. Status Stage of a GET DEVICE DESCRIPTOR Transaction SYNC Field of the Token Packet

4.3.2 EL_22: Inter-Packet-Gap Field of Device and Host Packets

When transmitting after receiving a packet, hosts and devices must provide an inter-packet-gap of at least 8-bit times and not more than 192-bit times.

To test this parameter, it is important to use a transaction that forces the C6748/46/42 and OMAP-L132/138 Host to source a packet in response to a reception of a packet from the known good device. The data stage of the GET DESCRIPTOR command is ideal transaction to measure the inter-packet-gap existing between the device responding with its descriptor data and the DUT Host acknowledging the reception by testing the gap time honored by the DUT Host C6748/46/42 and OMAP-L132/138 device.

Figure 10 displays the inter-packet-gap observed between the device and embedded Host packets.

Packet gap between device data packet and Host acknowledge packet: PASS

NOTE: Measured value: 215.23 ns => 215.23 ns x 480 Mbps = 103.3104 bits.

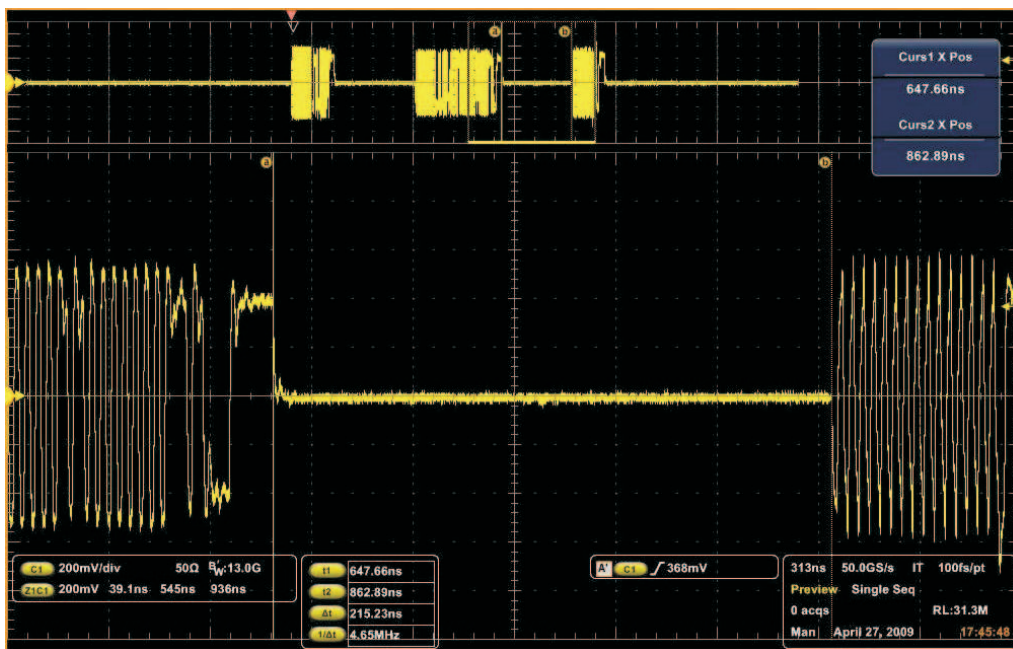

Figure 10. Inter-Packet-Gap Between the Data Packet of Device and Acknowledge Packet of the Embedded Host on the Data Stage of the GET DESCRIPTOR Command

4.3.3 EL_23: Inter-Packet-Gap Field of Back-to-Back Packets

The Host transmitting two packets in a row must have an inter-packet-gap of at least 8-bit times and not more than 192-bit times.

Figure 11 displays the inter-packet-gap between the token packet and the zero byte data packet of the status stage of a GET DESCRIPTOR command sourced from the DUT Host with the inter-packet-gap zoomed.

Packet gap between the Host token packet and the Host data packet: PASS

NOTE: Measured value: 249.1 ns => 249.1 ns x 480 Mbps = 119.568 bits.

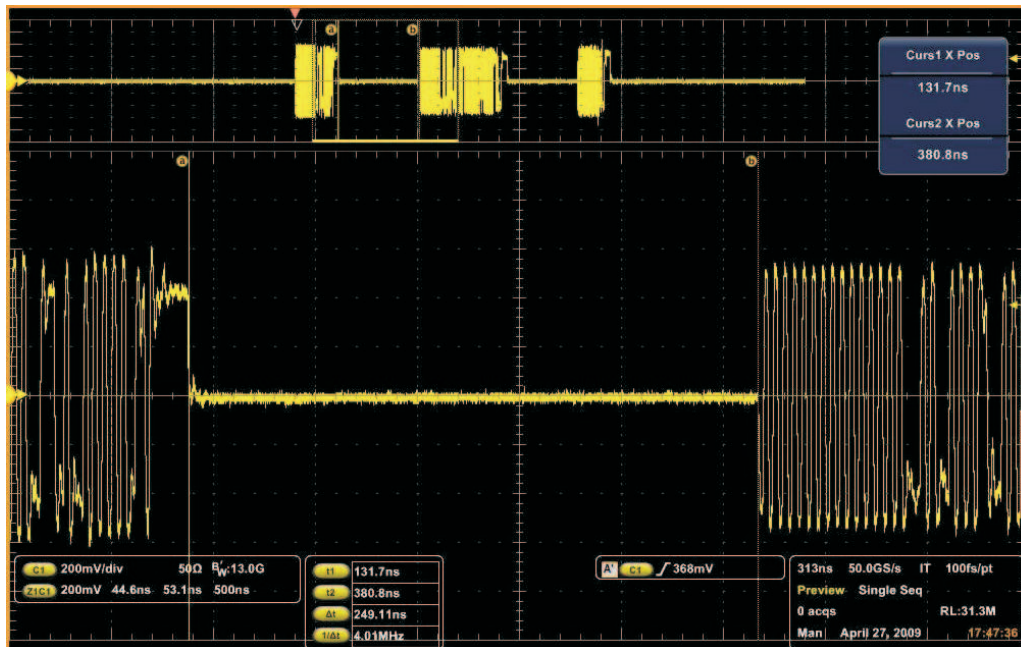

Figure 11. Inter-Packet-Gap Between the Token Packet and the Data Packet of the Status Stage of the GET DESCRIPTOR Transaction

4.3.4 EL_25: End-of-Packet (EOP) Field of Non-SOF Packets

The EOP for all transmitted packets (except SOF) must be an 8-bit NRZI byte of 01111111 without bit stuffing. Note, that a longer EOP is waiverable.

The EOP of the token packet or the data packet of the status stage can be used to verify this timing since both of these packets are sourced by the DUT C6748/46/42 and OMAP-L132/138 Host during the status stage of a GET DESCRIPTOR command. Figure 12 displays the EOP field of the data packet of the status stage of the GET DESCRIPTOR command.

Non-SOP EOP field: PASS.

NOTE: Measured value: 16.6 ns => 16.6 ns x 480 Mbps = 7.968 bits.

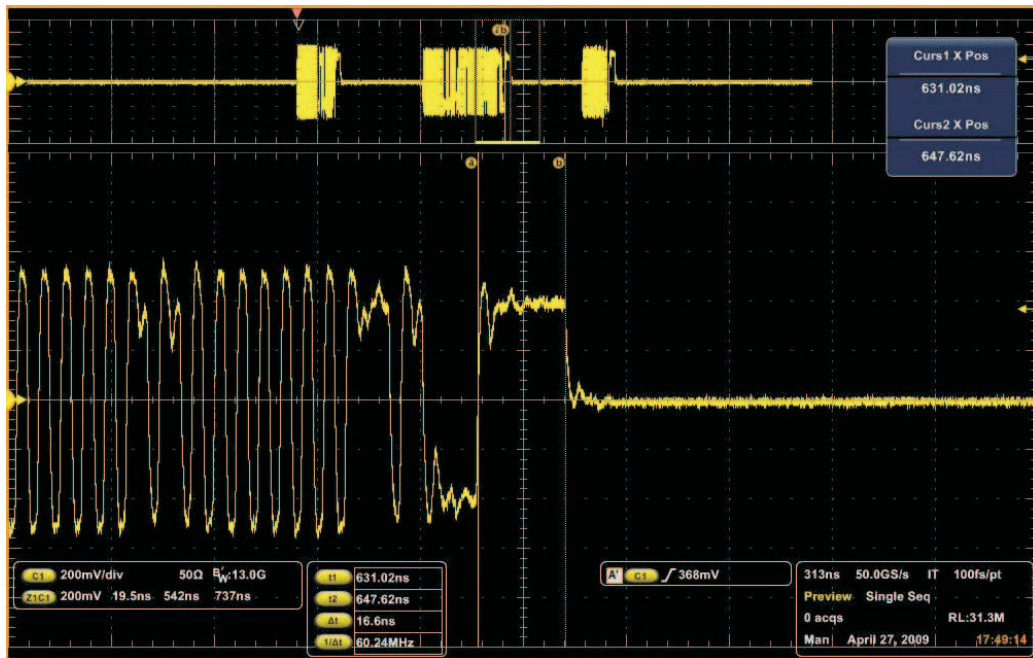

Figure 12. EOP Field of Non-SOP Packet of the Data Packet of the Status Stage of the GET DESCRIPTOR Command

4.3.5 EL_55: End-of-Packet (EOP) Field of SOF Packets

The Host transmitting SOF packets must provide a 40-bit EOP without bit stuffing where the first symbol of the EOP is a transition from the last data symbol. [Figure 13](#) displays the EOP field capture of a SOF packet.

SOF packet EOP Field: PASS.

NOTE: Measured value: 83.6 ns => 83.6 ns x 480 Mbps = 40.128 bits

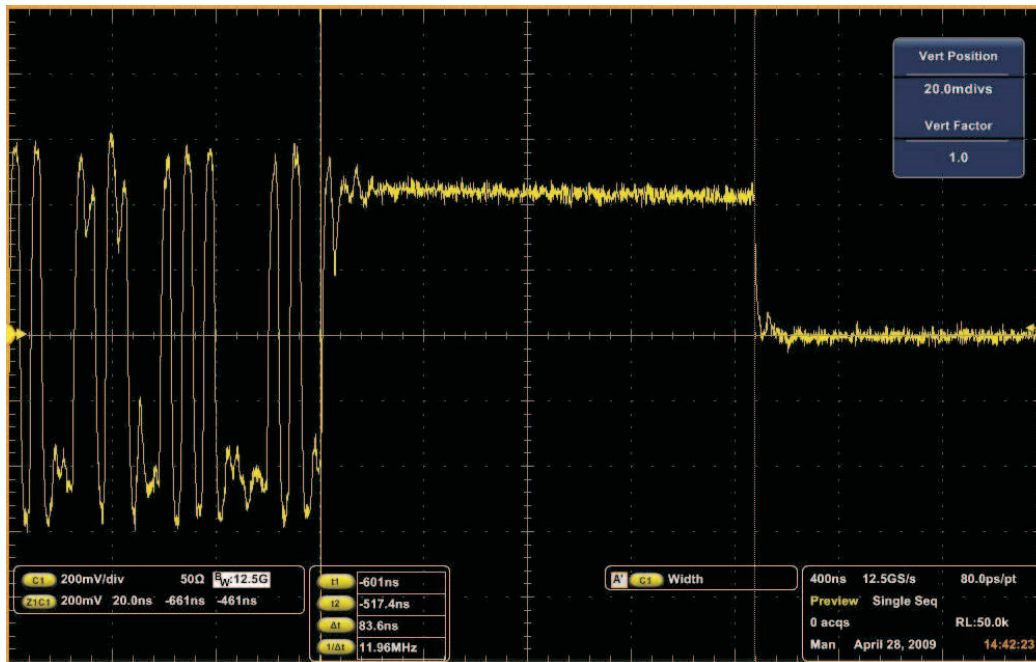

Figure 13. EOP Field of an SOP Packet

4.4 Device Chirp Timing

The Host chirp timing is used to validate high-speed detection handshake and happens during reset time. Some time after the Host resets a high-speed device, the device should indicate its high-speed capability by generating chirp-K signaling. A high-speed Host follows up by generating a minimum of three sets of chirp-KJ signaling at full-speed signaling environment. The device should disconnect its 1.5K Ω pull-up resistor and enable the 45 Ω termination resistors right after the last chirp J from the Host.

To invoke this test, a similar setup used for the device parameter testing, with two single ended FET probes replacing the differential probe, is used and shown on Figure 14.

There are several ways to perform this test. The method used here is to perform the test during an initial attachment. However, the embedded Host test software can be programmed to perform a RESET.

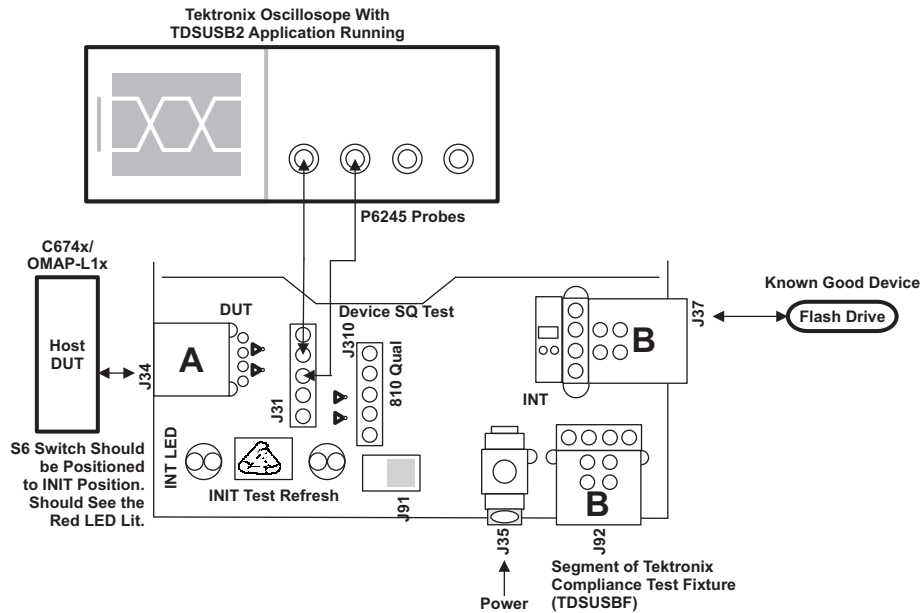

Figure 14. Equipment Setup for Downstream Host Chirp and Suspend and Resume Timings

4.4.1 EL_33: Chirp Response Timing

Downstream ports start sending and alternating a sequence of chirp K's and chirp J's within 100 μ s after the device chirp K stops. Should be \leq 100 μ s.

The device chirp K stop time is usually detected when the signal level of the chirp K drops around \diamond its high value.

Chirp response timing is the time between the device's de-assertion of chirp-K and the start of the alternate chirp-K and chirp-J sent by the Host.

Figure 15 displays the chirp response time measured for a downstream C6748/46/42 and OMAP-L132/138 Host device.

Chirp response time: PASS

NOTE: Measured value: 2.501855 μ s

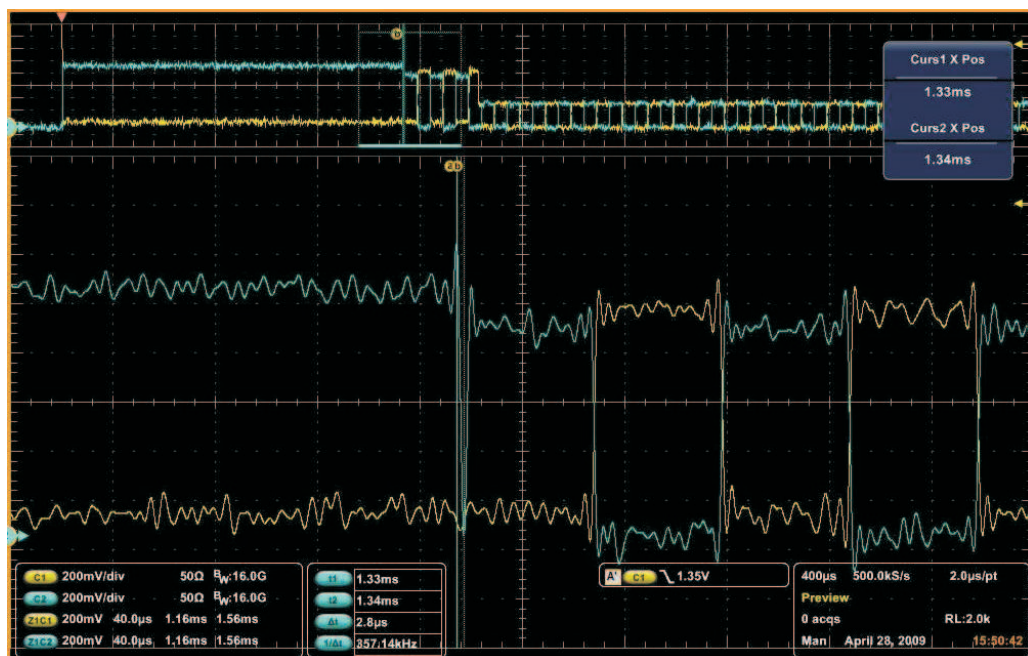

Figure 15. Downstream Chirp Response Time

4.4.2 EL_34: Chirp-K and Chirp-J Duration

Downstream ports start sending and alternating a sequence of chirp K's and chirp J's within 100 μ s after the device chirp K stops.

Chirp-K and chirp-J duration must be between 40 μ s and 60 μ s.

Figure 16 displays chirp-K and chirp-J duration measured for the C6748/46/42 and OMAP-L132/138 Host DUT device.

Chirp-K and chirp-J duration: PASS.

NOTE: Measured value: 49.23644 μ s and 51.79060 μ s

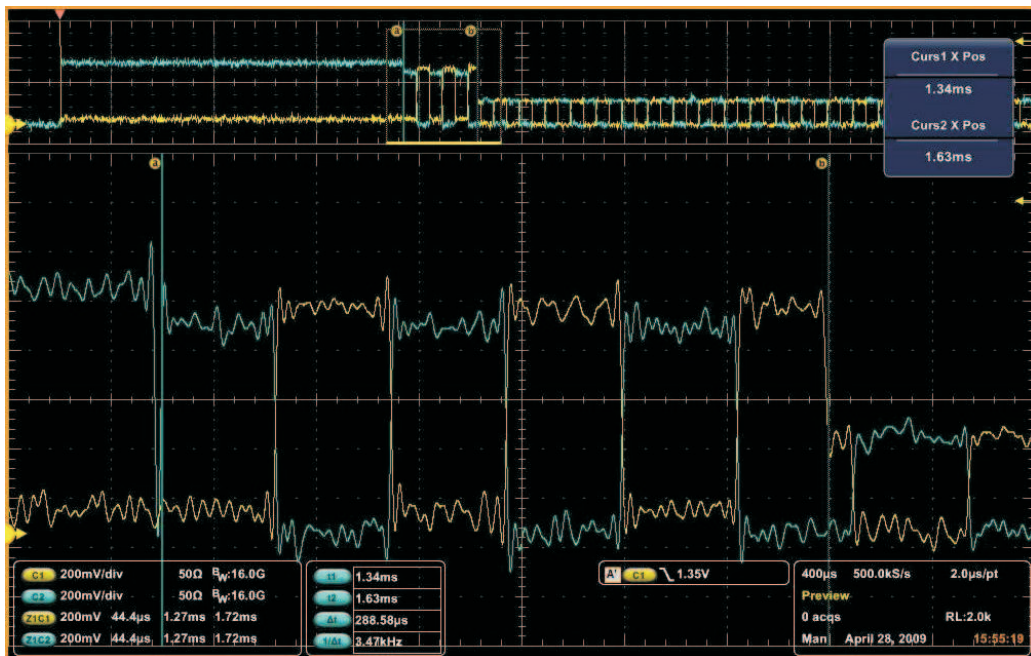

Figure 16. Chirp-K and Chirp-J Duration

4.4.3 EL_35: Time Between SOF and Last Chirp-(J or K)

The downstream C6748/46/42 and OMAP-L132/138 DUT Host should begin sending SOFs within 500 μ s and not sooner than 100 μ s from the transmission of the last chirp-(J or K).

Figure 17 displays the captured time for this event.

Time between SOF and the last chirp-(J or K): PASS

NOTE: Measured value: 124.7733 μ s.

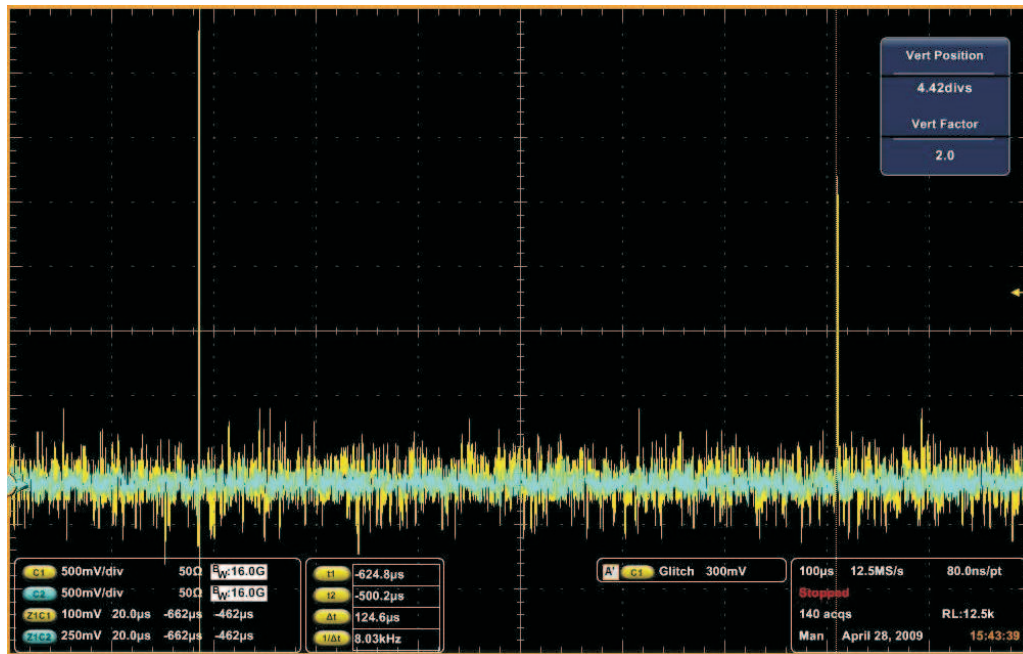

Figure 17. Time Between First SOF and Last Chirp-(J or K)

4.5 Host Suspend/Resume Timing

The embedded Host is attached to a known good high-speed device (Flash drive) and finishes up the enumeration process. The DUT Host does no transaction, but periodically generates a SOF packet to the attached high-speed device every 125 μ s.

The Host DUT is forced to transition to suspend state via the firmware when needed. The results are that the C6748/46/42 and OMAP-L132/138 Host DUT stops generating SOF packets.

To exit suspend mode and start the resume process, the DUT Host firmware does the following:

1. Clears the suspend bit
2. Sets the resume bit
3. Leaves the resume bit set for around 20 ms
4. Clears the resume bit

This will end the resume state.

Figure 14 displays the equipment setup for the suspend and resume tests.

4.5.1 EL_39: Host Suspend Timing

This is the time interval from the end of the last SOF packet issued by the DUT host to when the device attached its full-speed pull-up resistor on D+ (transition to full-speed J-state). This time should be between 3.0 ms and 3.125 ms. No measurement is required as this sequence verifies that the Host supports the suspend state.

The embedded Host is attached to a known good high-speed device (Flash drive) and finishes up the enumeration process. The DUT Host does no transaction, but periodically generates a SOF packet to the attached high-speed device every 125 μ s. The Host DUT is then forced to transition to suspend state via the Firmware. The results are that the C6748/46/42 and OMAP-L132/138 Host DUT stops generating SOF packets.

Figure 18 captures the signal capture of SOF from DUT Host vanishing when it enters into suspend mode along with the automatic result published by the TDSUSB2 software.

DUT Host support suspend capability: PASS

NOTE: Measured Value (by the TDSUSB2 S/W): 3.002907 ms.

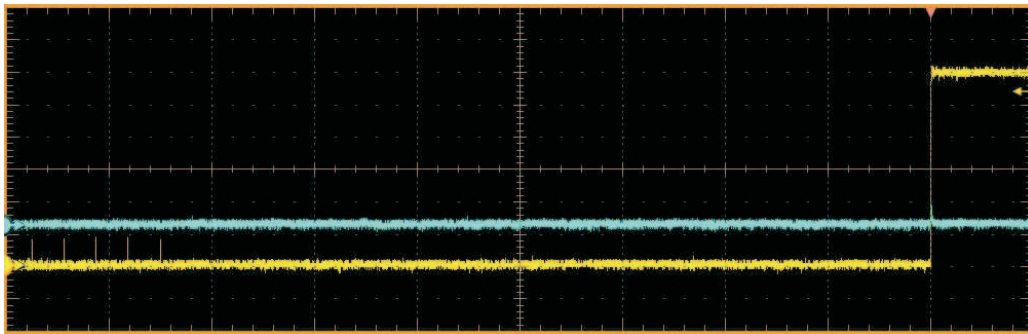

Figure 18. DUT Host Enters Suspend State

Measurement Name	Suspend Time	USB Limits	Status
Suspend Test	3.002907 ms	3.000000 ms to 3.125000 ms	Pass

4.5.2 EL_41: Host Resume Timing

After resuming a port, the Host must begin sending SOFs within 3 ms of the start of the idle state.

Figure 19 captures the resume signal capture alongside the automatic result generated by the TDSUSB2 software.

DUT Host support resume capability: PASS

NOTE: Measured Value: 2.492080 μ s

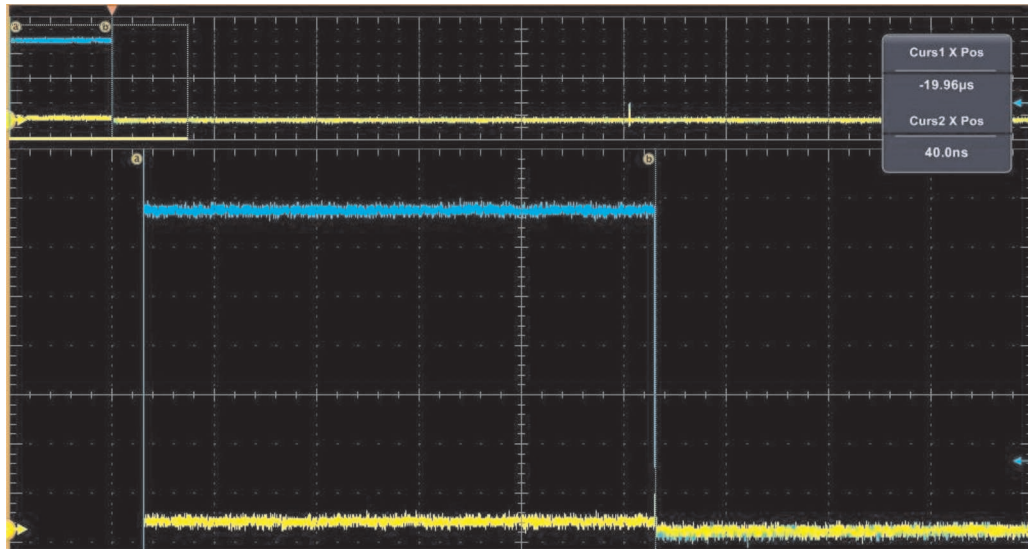

Figure 19. DUT Host Resumes

Measurement Name	Resume TIME	USB Limits	Status
Resume Test	2.492080 μ s	3.000000 ms	Pass

4.6 DUT Host Test_J/K, SE0

A USB 2.0 Specification compliant controller is required for the controller to support mandatory tests (where Test_SE0_NAK, Test_J, and Test_K are members of these tests). A digital multimeter is used to measure the DC voltage level of D+ and D- data lines after placing the controller in one of the test modes mentioned.

Test_SE0 places the controller in high-speed mode and keeps the controller from driving both D+ and D- data lines.

Figure 20 displays the equipment setup used for DUT Host Test_J, Test_K, and Test_SE0

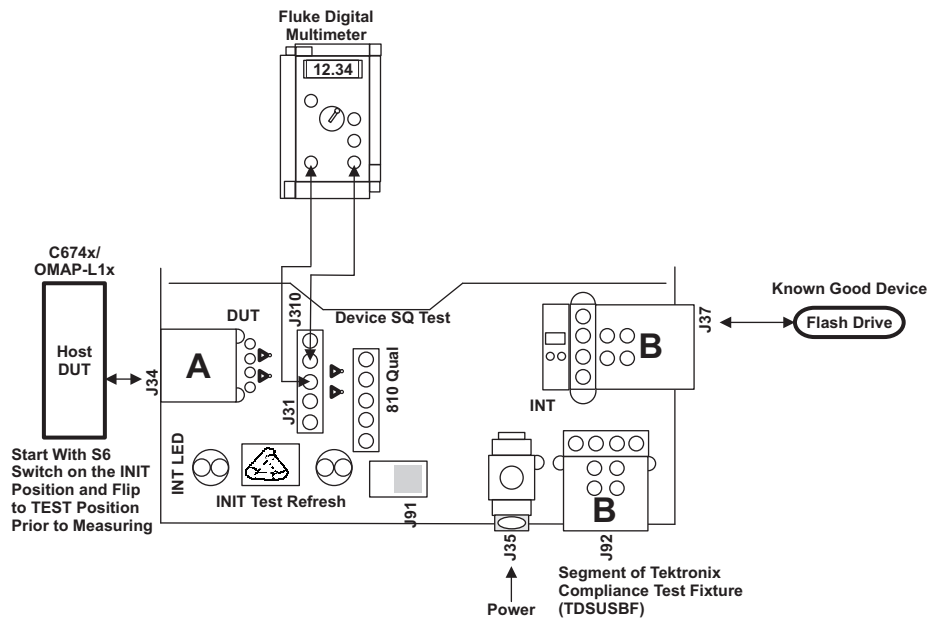

Figure 20. Equipment Setup for Downstream Test J/K, SEO_NAK

4.6.1 Test_J/ Test_K

4.6.1.1 Test_J

When the D+ is driven high, the output voltage must be $400\text{ mV} \pm 10\%$ when terminated with precision $45\ \Omega$ resistor.

D+ data line DC voltage level: PASS

NOTE: Measured value: 0.389 V

D- data line DC voltage level: PASS

NOTE: Measured value: 0.0 V

4.6.1.2 Test_K

When the D- is driven high, the output voltage must be $400\text{ mV} \pm 10\%$ when terminated with precision $45\ \Omega$ resistor.

D- data line DC voltage level: PASS

NOTE: Measured value: 0.388 V

D+ data line DC voltage level: PASS

NOTE: Note: Measured value: 0.0 V

4.6.2 EL_9: Test_SE0

When either D+ and D- are not being driven, the output voltage must be $0V \pm 10\%$ when terminated with precision 45Ω resistors to ground.

D+ data line DC voltage level: PASS

NOTE: Measured value: 0.0 V

D- data line DC voltage level: PASS

NOTE: Measured value: 0.0 V

4.7 Legacy USB Compliance Testing

An eye diagram provides an intuitive view of jitter. It is a composite view of all the bit periods of a captured waveform superimposed upon each other. Full-speed and low-speed signal quality tests are good enough to determine that the embedded high-speed Host is capable of interacting with legacy devices that happen to be full- or low-speed in nature.

4.7.1 Full-Speed Downstream Signal Quality Test

For a full-speed downstream signal quality test, it is necessary to cascade four self-powered high-speed hubs and one self-powered full-speed hub with five meters of USB cables. The TDSUSB2F fixture is connected to the embedded Host with a known good five meter USB cable. The self-powered full-speed hub is directly attached (without using a short cable) to the TDSUSB2F fixture on the opposite side at the Tier 1 position. The remaining high-speed hubs are cascaded with five meter cables. A known good full-speed device, in this case a USB 1.1 Flash drive, is connected to the last high-speed hub via a five meter USB cable. [Figure 21](#) displays the equipment setup for a full-speed downstream signal quality test.

To capture the signal quality test, it is necessary to enumerate the attached USB 1.1 device. Since the embedded Host is configured to operate at full-speed after the completion of the enumeration process, it will generate a start of frame packet at the start of every frame. This packet is good enough to perform the full-speed signal quality test.

Figure 21 displays the equipment setup for the full-speed downstream signal quality test.

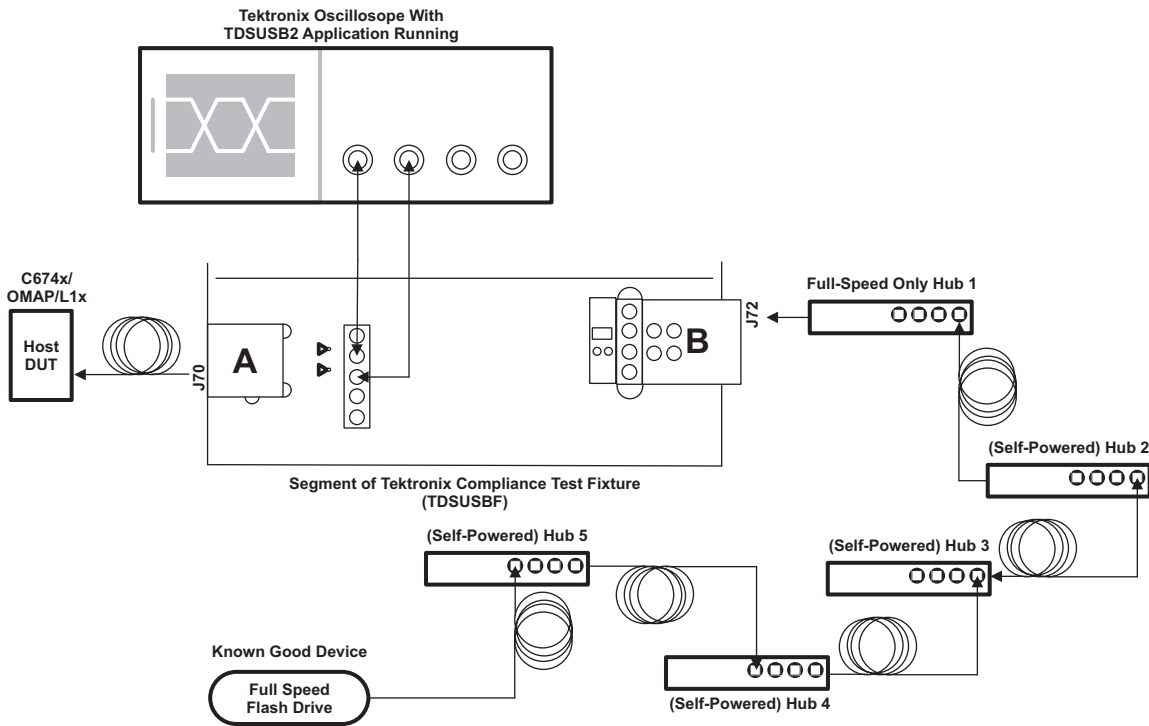

Figure 21. Equipment Setup for Full-Speed Downstream Host Signal Quality Testing

Figure 22 displays the full-speed waveform plot as it is captured by the TDSUSB2F software.

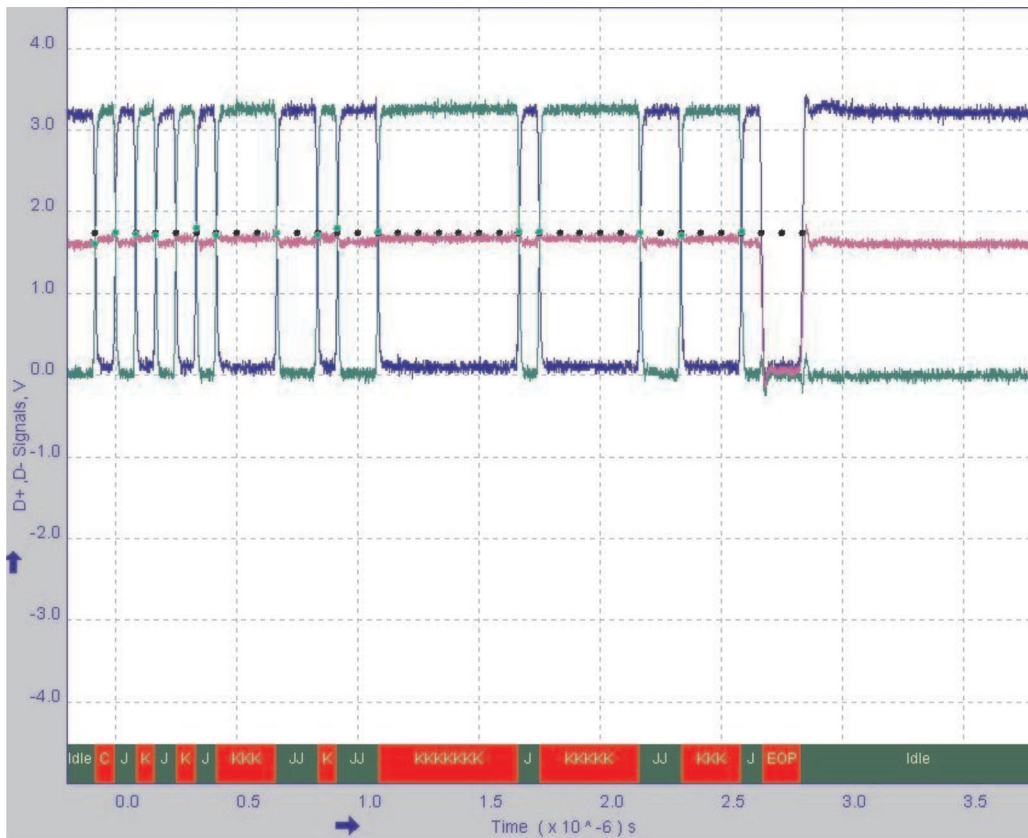

Figure 22. Waveform Plot

Figure 23 displays the eye diagram for the full-speed downstream Host.

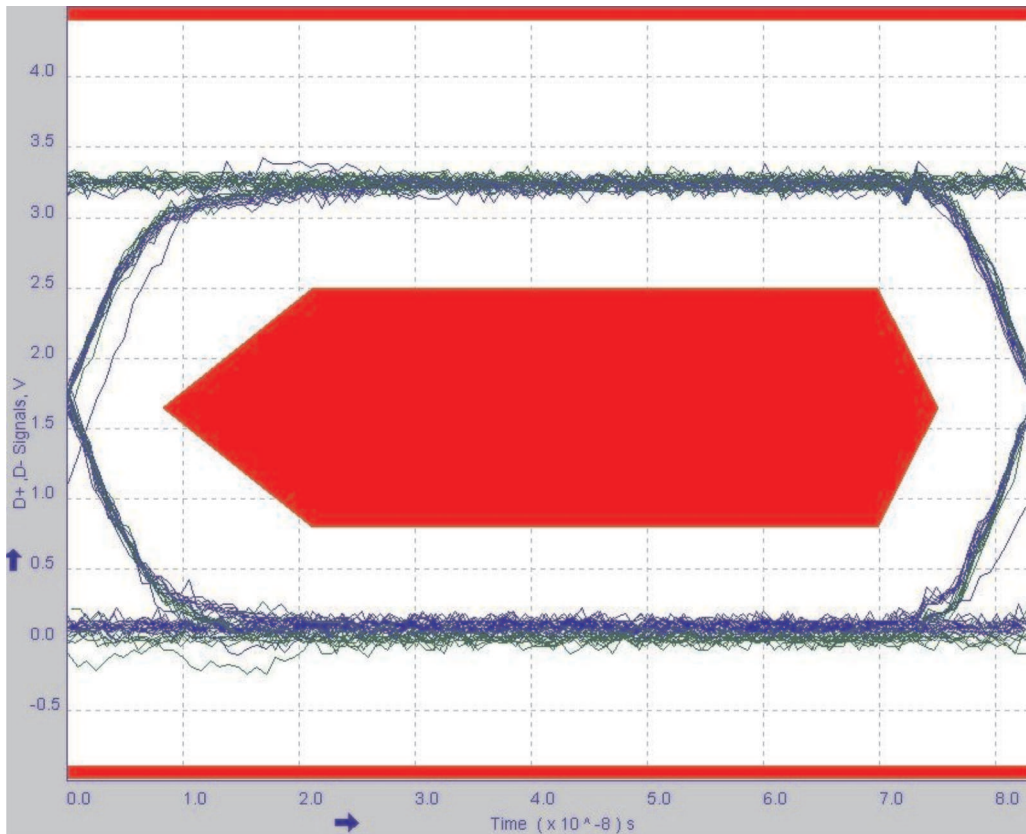

Figure 23. Full-Speed Eye Diagram

Table 7 displays the detailed result for the downstream full-speed signal quality testing.

Table 7. Result Summary for Full-Speed Downstream Host Signal Quality

Measurement Name	Minimum	Maximum	Mean	pk-pk	Standard Deviation	RMS	Pop.	Status (1)
Eye diagram test	-	-	-	-	-	-	-	Pass
Signal rate	11.97349 Mbps	12.04673 Mbps	12.00062 Mbps	0.0000 bps	18.78598 kbps	12.00320 Mbps	31	Pass
Crossover voltage	1.604300 V	1.798424 V	1.733697 V	194.1235 mV	46.12855 mV	1.734269 V	15	Pass
EOP width	-	-	168.8624 ns	-	-	-	1	Pass
Consecutive jitter	-220.7941 ps	142.0142 ps	-9.876668 ps	362.8083 ps	118.2312 ps	114.3577 ps	14	Pass
Paired JK jitter	-179.2898 ps	86.32511 ps	-53.15804 ps	265.6149 ps	109.9732 ps	113.5966 ps	6	Pass
Paired KJ jitter	-239.1476 ps	232.6850 ps	15.12188 ps	471.8326 ps	164.2843 ps	150.7308 ps	6	Pass
Falling Edge Rate	193.8237 V/μs	229.7219 V/μs	214.1485 V/μs	35.89818 V/μs	10.43499 V/μs	214.3877 V/μs	17	Pass
Rising Edge Rate	189.6084 V/μs	226.9610 V/μs	213.4049 V/μs	37.35260 V/μs	9.809686 V/μs	213.6161 V/μs	16	Pass

(1) Because the individual status of the measurements are Pass and performed on Tier 6 (as per USB-IF), the overall result for this test is PASS.

4.7.2 Low-Speed Downstream Signal Quality Test

The best method to capture and analyze low-speed downstream signal quality is to capture both a keep-alive (low-speed EOP) and a packet. The embedded Host is required to either generate a keep-alive or send low-speed traffic once per frame whenever a low-speed device is directly attached to achieve this LOOP GET DESCRIPTOR command is issued from the embedded Host; this is achieved by the Host issuing the GET DESCRIPTOR Command continually. The scope is configured to trigger on the packets transmitted by the Host. The triggering part is sometimes found to be hard depending upon the type of scope and its bandwidth. High bandwidth scopes are not ideal for USB compliance testing.

To achieve a stable trigger, it was necessary on our setup to modify the trigger hold off parameter. For a stable display of repetitive signals, trigger hold off allows you to match the trigger timing with pseudo-random bit streams. It was necessary to play with this setting in order to get a stable trigger for the TDSUSB2 software to measure the signal quality for low-speed downstream configuration. Even though values larger than 1 ms would also work, it is advisable to obtain a hold off value less than one ms that allows stable trigger on multiple packets within a frame.

Figure 24 displays the equipment setup for a low-speed downstream signal quality test.

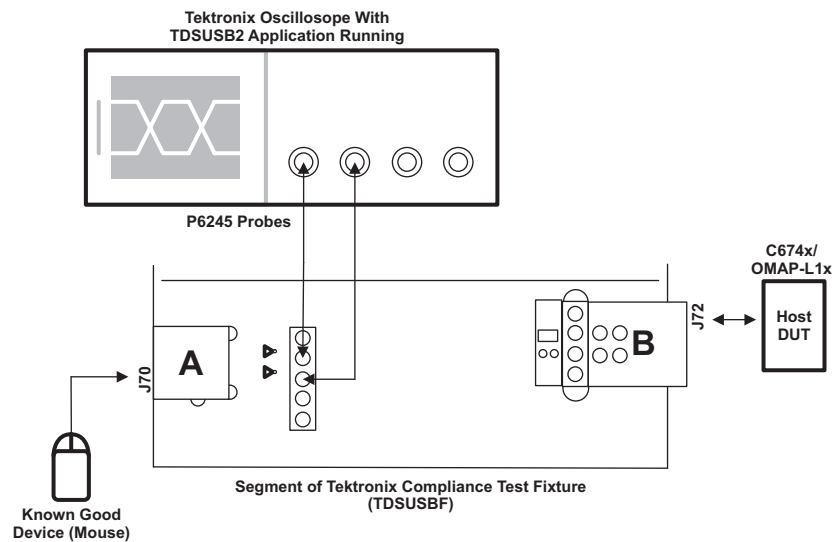

Figure 24. Equipment Setup for Low-Speed Downstream Host Signal Quality Testing

Figure 25 displays the low-speed waveform plot as it is captured by the TDSUSB2F software.

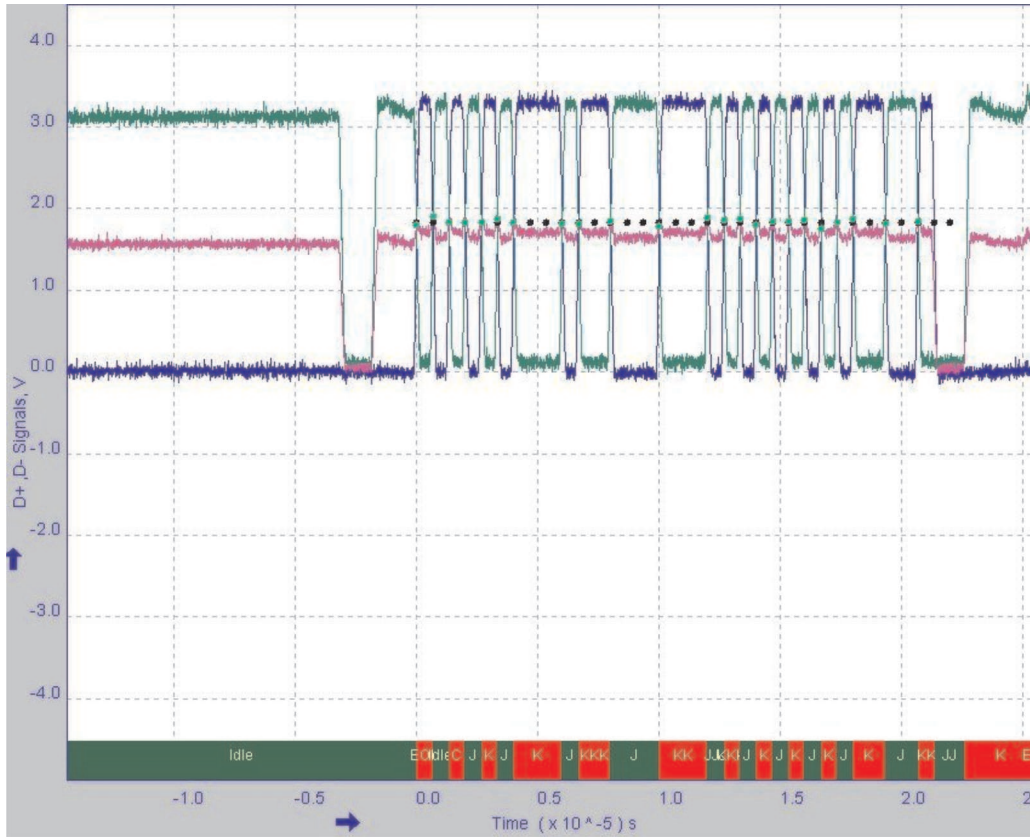

Figure 25. Low-Speed Waveform Plot

Figure 26 displays the eye diagram for low-speed downstream Host.

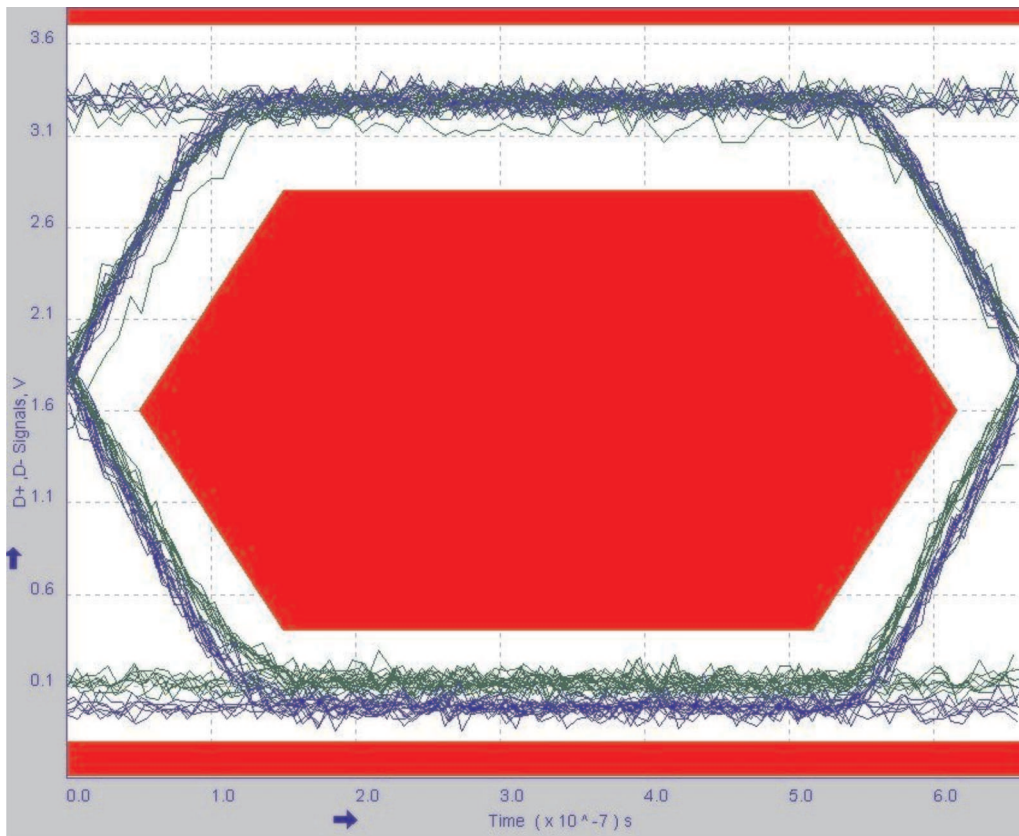

Figure 26. Low-Speed Eye Diagram

Table 8 displays the detailed result for the downstream low-speed signal quality testing.

Table 8. Result Summary for Low-Speed Downstream Host Signal Quality Test⁽¹⁾

Measurement Name	Minimum	Maximum	Mean	pk-pk	Standard Deviation	RMS	Pop.	Status ⁽²⁾
Eye diagram test	-	-	-	-	-	-	-	Pass
Signal rate	1.477204 Mbps	1.524028 Mbps	1.499742 Mbps	0.0000 bps	14.27835 kbps	1.498660 Mbps	30	Pass
Crossover voltage	1.756631 V	1.896771 V	1.833731 V	140.1404 mV	34.12383 mV	1.834035 v	23	Pass
EOP width	-	-	1.363937 μ s	-	-	-	1	Pass
Consecutive jitter	-7.221072 ns	6.307090 ns	180.2733 ps	13.52816 ns	4.174944 ns	4.082938 ns	22	Pass
Paired JK jitter	-4.259368 ns	3.561559 ns	239.3629 ps	7.820927 ns	2.364884 ns	2.256259 ns	10	Pass
Paired KJ jitter	-4.339321 ns	7.634606 ns	624.6793 ps	11.97393 ns	3.687399 ns	3.553512 ns	10	Pass
Falling edge rate	12.98209 V/ μ s	15.26678 V/ μ s	13.88313 V/ μ s	2.284690 V/ μ s	693.0299 mV/ μ s	13.89972 V/ μ s	25	Pass
Rising edge rate	13.28562 V/ μ s	16.17908 V/ μ s	14.93129 V/ μ s	2.893466 V/ μ s	796.6515 mV/ μ s	14.95164 V/ μ s	24	Pass

⁽¹⁾ Additional Information:

- Rising Edge Rate: 14.93129 V/ μ s (Equivalent rise time = 176.81 ns)
- Falling Edge Rate: 13.88313 V/ μ s (Equivalent fall time = 190.16 ns)

⁽²⁾ Because the individual status of the measurements are Pass and performed on Tier 6 (as per USB-IF), the overall result for this test is PASS.

NOTE: The actual Tier level for the low-speed device used (mouse) was Tier 1, as is shown on the equipment setup diagram. During the time when the test was performed, the TDSUSB2 software has a bug that required the Tier number to be selected as Tier 6. Table 8 captures the test device position as such. This is a display error and does not comprise the integrity of the test.

5 References

- *Host High-Speed Electrical Test Procedure* documentation issued by the USB Implementers Forum (<http://www.usb.org/home>)

IMPORTANT NOTICE

Texas Instruments Incorporated and its subsidiaries (TI) reserve the right to make corrections, modifications, enhancements, improvements, and other changes to its products and services at any time and to discontinue any product or service without notice. Customers should obtain the latest relevant information before placing orders and should verify that such information is current and complete. All products are sold subject to TI's terms and conditions of sale supplied at the time of order acknowledgment.

TI warrants performance of its hardware products to the specifications applicable at the time of sale in accordance with TI's standard warranty. Testing and other quality control techniques are used to the extent TI deems necessary to support this warranty. Except where mandated by government requirements, testing of all parameters of each product is not necessarily performed.

TI assumes no liability for applications assistance or customer product design. Customers are responsible for their products and applications using TI components. To minimize the risks associated with customer products and applications, customers should provide adequate design and operating safeguards.

TI does not warrant or represent that any license, either express or implied, is granted under any TI patent right, copyright, mask work right, or other TI intellectual property right relating to any combination, machine, or process in which TI products or services are used. Information published by TI regarding third-party products or services does not constitute a license from TI to use such products or services or a warranty or endorsement thereof. Use of such information may require a license from a third party under the patents or other intellectual property of the third party, or a license from TI under the patents or other intellectual property of TI.

Reproduction of TI information in TI data books or data sheets is permissible only if reproduction is without alteration and is accompanied by all associated warranties, conditions, limitations, and notices. Reproduction of this information with alteration is an unfair and deceptive business practice. TI is not responsible or liable for such altered documentation. Information of third parties may be subject to additional restrictions.

Resale of TI products or services with statements different from or beyond the parameters stated by TI for that product or service voids all express and any implied warranties for the associated TI product or service and is an unfair and deceptive business practice. TI is not responsible or liable for any such statements.

TI products are not authorized for use in safety-critical applications (such as life support) where a failure of the TI product would reasonably be expected to cause severe personal injury or death, unless officers of the parties have executed an agreement specifically governing such use. Buyers represent that they have all necessary expertise in the safety and regulatory ramifications of their applications, and acknowledge and agree that they are solely responsible for all legal, regulatory and safety-related requirements concerning their products and any use of TI products in such safety-critical applications, notwithstanding any applications-related information or support that may be provided by TI. Further, Buyers must fully indemnify TI and its representatives against any damages arising out of the use of TI products in such safety-critical applications.

TI products are neither designed nor intended for use in military/aerospace applications or environments unless the TI products are specifically designated by TI as military-grade or "enhanced plastic." Only products designated by TI as military-grade meet military specifications. Buyers acknowledge and agree that any such use of TI products which TI has not designated as military-grade is solely at the Buyer's risk, and that they are solely responsible for compliance with all legal and regulatory requirements in connection with such use.

TI products are neither designed nor intended for use in automotive applications or environments unless the specific TI products are designated by TI as compliant with ISO/TS 16949 requirements. Buyers acknowledge and agree that, if they use any non-designated products in automotive applications, TI will not be responsible for any failure to meet such requirements.

Following are URLs where you can obtain information on other Texas Instruments products and application solutions:

Products

Audio	www.ti.com/audio
Amplifiers	amplifier.ti.com
Data Converters	dataconverter.ti.com
DLP® Products	www.dlp.com
DSP	dsp.ti.com
Clocks and Timers	www.ti.com/clocks
Interface	interface.ti.com
Logic	logic.ti.com
Power Mgmt	power.ti.com
Microcontrollers	microcontroller.ti.com
RFID	www.ti-rfid.com
OMAP Mobile Processors	www.ti.com/omap
Wireless Connectivity	www.ti.com/wirelessconnectivity

Applications

Communications and Telecom	www.ti.com/communications
Computers and Peripherals	www.ti.com/computers
Consumer Electronics	www.ti.com/consumer-apps
Energy and Lighting	www.ti.com/energy
Industrial	www.ti.com/industrial
Medical	www.ti.com/medical
Security	www.ti.com/security
Space, Avionics and Defense	www.ti.com/space-avionics-defense
Transportation and Automotive	www.ti.com/automotive
Video and Imaging	www.ti.com/video

TI E2E Community Home Page

e2e.ti.com

Mailing Address: Texas Instruments, Post Office Box 655303, Dallas, Texas 75265
Copyright © 2011, Texas Instruments Incorporated