

Plastic Ball Grid Array (PBGA)

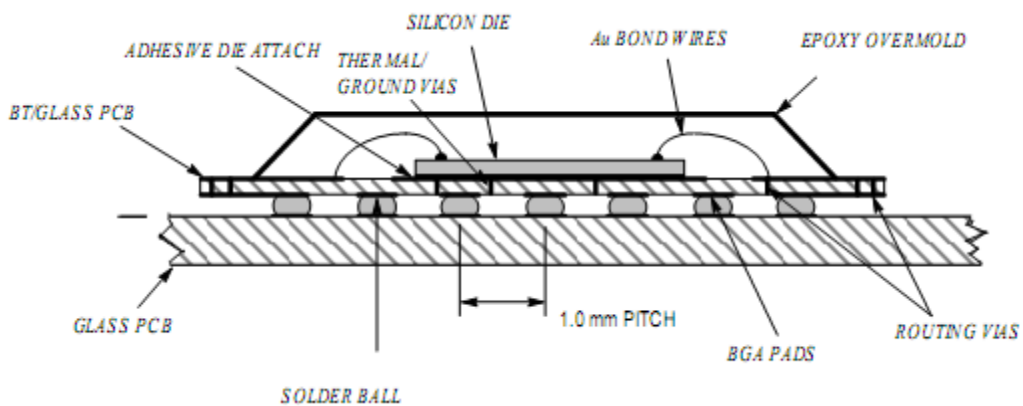

1.0 Introduction:

The Plastic Ball Grid Array or PBGA package, qualified and ramped by Texas Instruments Philippines is a cavity-up laminate based substrate package in which the die is attached to the substrate in the normal die up manner. The wire-bonded device and the complete assembly is then overmolded and solder balls attached to form the package. This package provides a cost-effective packaging solution, offering higher density over traditional leadframe packages. Texas Instruments' advanced design and simulation capabilities enable package optimizations needed for maximum electrical and thermal performance. The PBGA package is offered in a range of sizes from 17mm x 17mm to 35mm x 35mm, in ball pitch of 0.8mm and 1.0mm, to provide a ball count ranging from 208 to 976 balls. PBGA packages are available in 2 and 4 layer substrate designs.

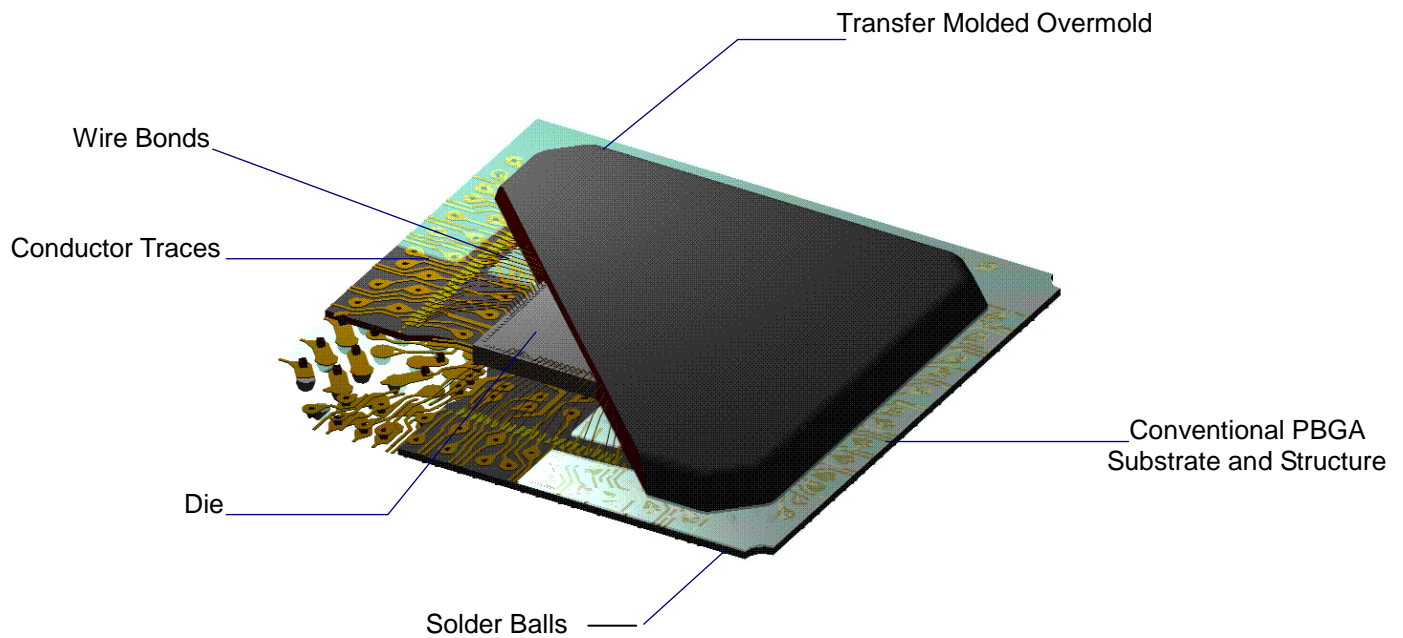

PBGA Package Configuration



Typical Nominal Dimensions of Selected pBGA Substrate Features

Features	Dimensions (mm)	Comments
Substrates Thickness (2ML)	0.56 +/- 0.04	Overall thickness (Core+SR+inner layer+outer layer)
Substrate Thickness (4ML)	0.61 +/- 0.05	Overall thickness (Core+SR+inner layer+outer layer)
Copper Thickness	0.015	
Trace/Space Widths	0.05	minimum
Soldermask Thickness	0.02	Over Copper
Via	0.2	Normal
Solder Pad Cu	0.60~0.65	
Solder Mask Opening	0.40~0.50	

Typical process flow for PBGA assembly

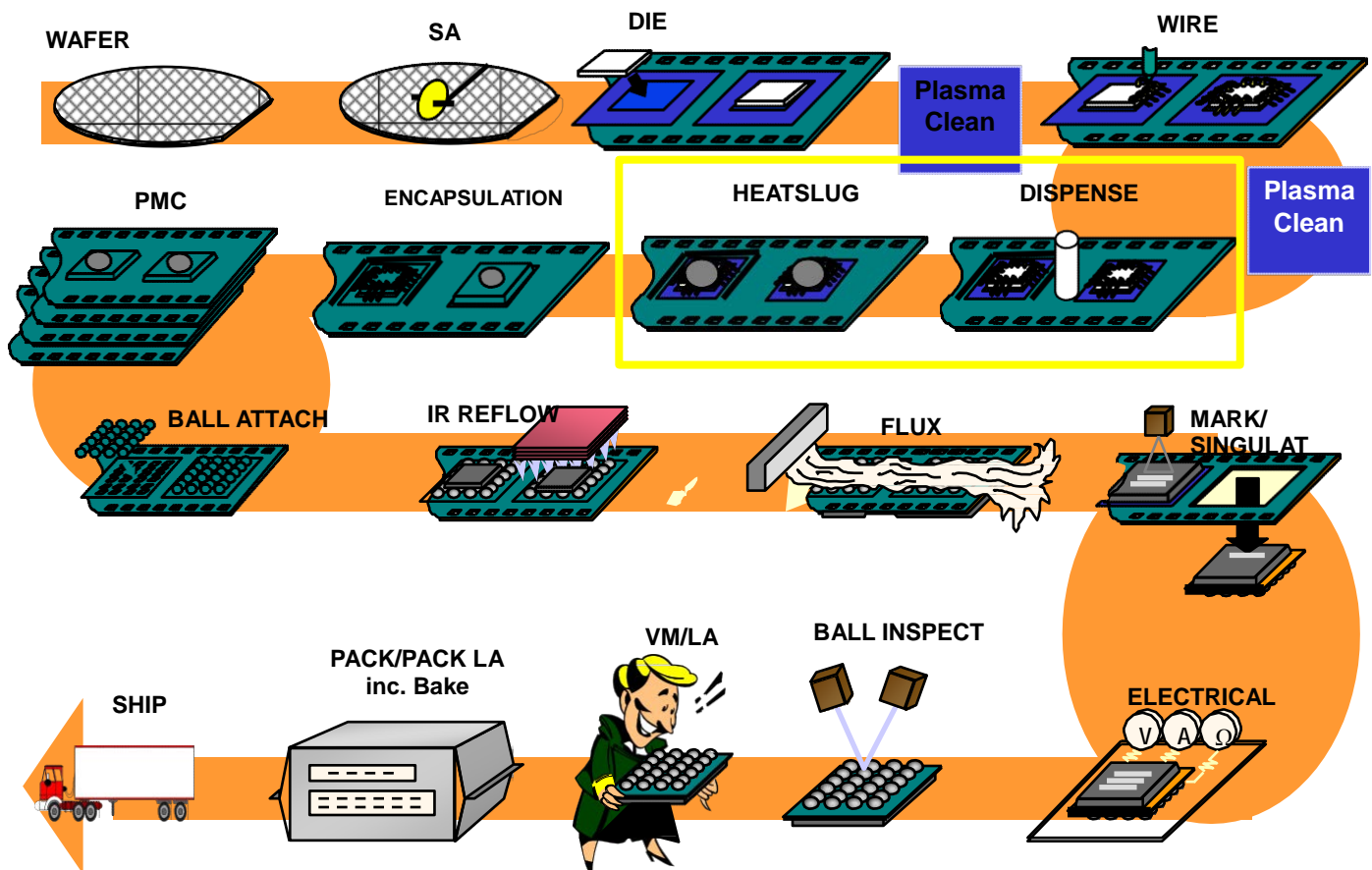

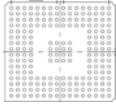
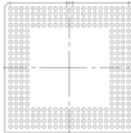
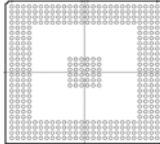
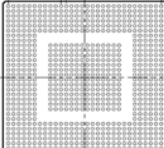
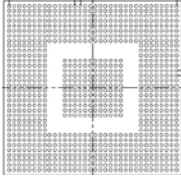
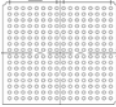
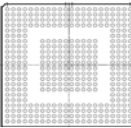
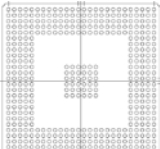
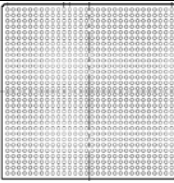
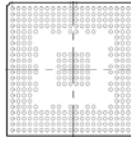
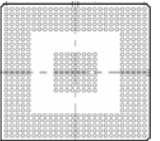
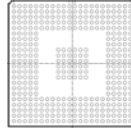
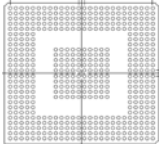
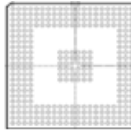
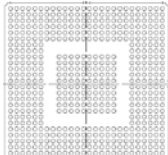
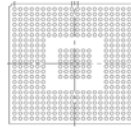
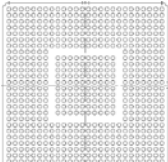
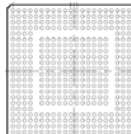
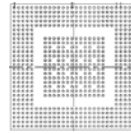

pBGA Package Product Guide

Pitch (mm)	Package Size (mm)				
	17x17	23x23	27x27	31x31	35x35
1	 208ZFE/ZKB	 288ZDQ	 388ZDS	 772ZXM	 976ZEY
	 256ZDH/ZFE/ZKB	 324ZDU/ZDW	 456ZXF/ZXZ	 900ZXM	
		 352ZDU	 484ZED		
		 376ZDW/ZDU	 520ZXF		
		 388ZDW	 580ZEQ		
		 420ZDQ	 632ZXZ		
		 432ZDU			
0.8		 640ZKK			



A typical package outline with 1mm pitch and appropriate tolerances are shown below.

ZXZ (S-PBGA-N456)

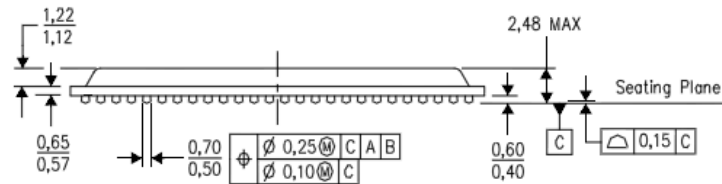
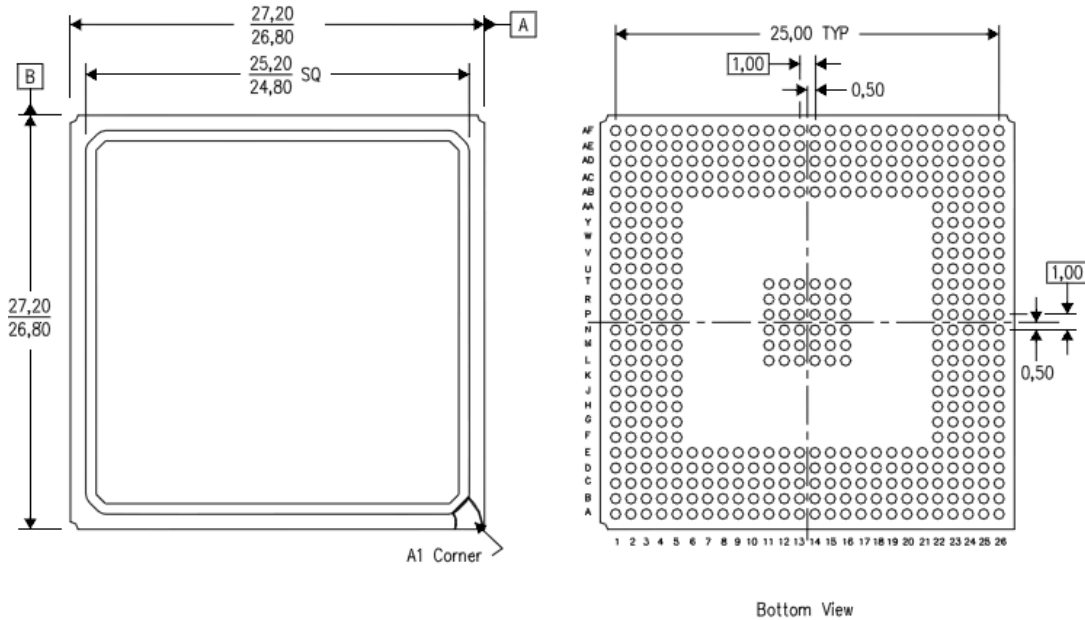

2.0 PC Board Design Guidelines:

The PBGA is compliant with JEDEC MS-034. IPC-SM-782 usually dictates the guidelines by which the PC Board (PCB) pattern should be designed. Working with an Electronics Manufacturing Service provider and/or PCB design house with experience designing and mounting this package type is recommended. The following guidelines are offered based on best known practice at the moment based on Texas Instruments evaluations and research.

- Package Height ranges depending on body size, ball size and layer count.
- Package Size Ranging from 17mm x 17mm to 35mm x35mm
- Ball Pitch 0.8 mm and 1.0mm

The PBGA package is primarily composed of copper laminated BT substrate. This adds stiffness to the package and uniform expansion during board mount and board level temperature cycling. Also, because of cavity up configuration, the solder balls for this package may be placed in a complete array over the entire bottom side. Therefore, balls immediately under the die may be used as thermal paths to further enhance the thermal performance.



2.1 PCB Land Pattern and Solder Mask Design

The solder lands on the package side are always Solder Mask Defined (SMD). The land pattern on the PCB should be designed to correspond with the land pattern on the package. The land on the PCB should be Non-Solder Mask Defined (NSMD) in order to realize the best board level reliability performance.

SOLDER PAD GEOMETRY

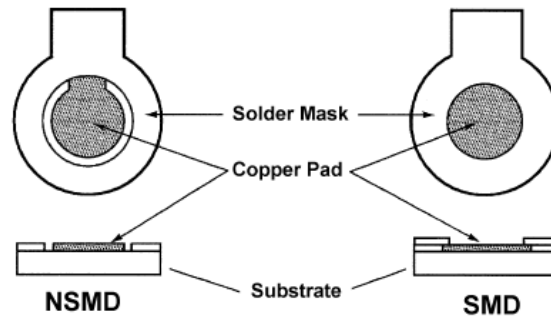

For NSMD pads, TI recommends a clearance (typically 3 mils) between the copper pad and solder mask to avoid overlap between the solder joint and solder mask due to mask registration tolerances.

The diameter of the solder ball land on the PCB should be the same or up to 20% less than that of the package substrate solder land. The trace leading into the NSMD ball land on the PCB should not exceed more than 50% of the land diameter. Again, this is to avoid too much solder wetting this lead-in to the ball thereby creating too much ball collapse and possibly impacting board level reliability.

Optium Land Configurations

All measurements in mm		Ball size, SMO, Pad Size and Apertures are shown in Diameters				
Ball Pitch	Solder Mask Type	PCB Design		Stencil Design		Area Aspect Ratio
		SMO	Pad Size	Thickness	Aperature	
0.8	SMD	0.400	0.500	0.152	0.400	0.66
	NSMD	0.500	0.400			
1	SMD	0.450	0.550	0.152	0.450	0.74
	NSMD	0.550	0.450			

Note: Area Aspect Ratio = Area of Aperture / Area of Aperture Wall

Note: For optial release of solder paste, it is recommended Area Aspect Ratio ≥ 0.66



2.2 Escape routing guidelines

A typical PBGA has four or five rows of solder balls around the periphery of the package. The number of lines routed (N) between the pads on the PCB is defined by the pad size and trace (width and spacing) fabrication capabilities of the PCB manufacturer. For NSMD pads, exposure of underlying copper traces is forbidden, so the diameter and tolerance of the solder mask opening define D . The following relationship is used to define N :

$$N = \frac{P - D - S}{L + S}$$

Figure 8. P = Pad Pitch
D = Pad Diameter
L = Line Width
S = Line Space

As shown below, 1 mm ball pitch with 4 rows of solder balls can be routed to 4 layers of PCB which uses a 0.125 mm line width and 0.125 mm line space.

1 mm Ball Pitch with 0.125 mm Line Width/Spacing

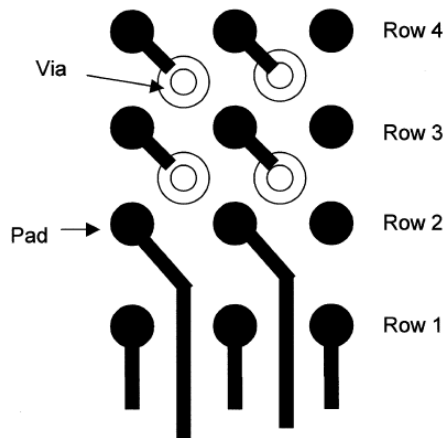



Routing for 5 rows of solder ball 1 mm Ball Pitch with 0.1 mm Line Width/Spacing

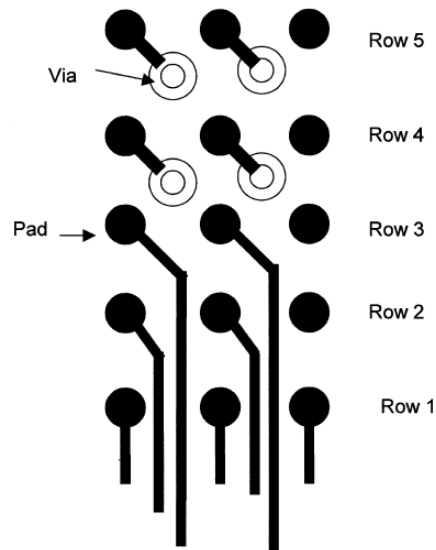

3.0 Assembly Recommendations

3.1 PROCESS FLOW & SET-UP RECOMMENDATION

The BGA surface mount assembly process flow includes:

- PCB plating requirements
- Screen printing the solder paste on the PCB
- Monitoring the solder paste volume (uniformity) , preferably using solder paste inspection machine
- Package placement using standard SMT placement equipment
- X-ray inspection prior to reflow to check for placement accuracy and other defects such as solder paste bridging
- Reflow and flux residue cleaning (dependent upon the paste type)
- X-ray inspection after reflow to check for defects such as solder bridging & voids

3.2 PCB PLATING RECOMMENDATIONS

A uniform PCB plating thickness is key for high assembly yield.

- PCB with Organic Solderability Preservative coating (OSP) finish is recommended.
- For PCBs with electroless or immersion gold finish, the gold thickness recommendation is $0.15 \mu\text{m} \pm 0.05 \mu\text{m}$ to avoid solder joint embrittlement. For PCBs with Hot Air Solder Leveling (HASL), the surface flatness should be controlled within $28 \mu\text{m}$.



3.3 SOLDER PASTE PRINTING

Solder paste deposition by the stencil-printing process involves the transfer of the solder paste through pre-defined apertures with the application of pressure. Stencil parameters such as aperture area ratio and the stencil fabrication method have a significant impact on paste deposition. Inspection of the stencil prior to placement of the BGA package is highly recommended to improve board assembly yields. Aperture size to PCB pad size is typically 1:1 ratio with 0.100 to 0.125 mm thick stencil.

Three typical stencil fabrication methods include:

- Chem-etch
- Laser cut
- Electroform (Metal additive processes)

Nickel-plated electro polished chem-etch or laser cut with tapered aperture walls (5° tapering) is recommended to facilitate paste release.

3.4 PASTE RECOMMENDATIONS

Type 3/4 water soluble or no-clean solder pastes are acceptable.

- 37%Pb-63%Sn eutectic paste for tin-lead process with tin-lead PBGA device
- Sn-3%Ag-0.5%Cu lead free paste for lead free process lead free PBGA device

3.5 COMPONENT PLACEMENT

BGA packages are placed using standard pick and place equipment with a placement accuracy of ± 0.10 mm. Component pick and place systems are composed of a vision system that recognizes and positions the component and a mechanical system which physically performs the pick and place operation. Two commonly used types of vision systems are: (1) a vision system that locates a package silhouette and (2) a vision system that locates individual bumps on the interconnect pattern. Both methods are valid since the parts align due to self-centering feature of the BGA solder joint during solder reflow. The latter vision system while providing greater accuracy tends to be more expensive and time consuming. BGAs have excellent self-alignment during solder reflow if a minimum of 50% of the ball is aligned with the pad. The 50% accuracy is in both the X and Y direction as determined by the following relation.

BGA self centering

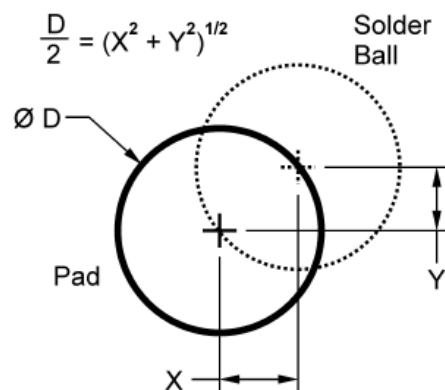



3.6 REFLOW

Finally, successful reflow cycles strike a balance among temperature, timing, and length of cycle. Mistiming may lead to excessive fluxing activation, oxidation, excessive voiding, or even damage to the package. Heating the paste too hot, too quickly before it melts can also dry the paste, which leads to poor wetting. Process development is needed to optimize reflow profiles for each solder paste/flux combination

The BGA may be assembled using standard IR or IR convection SMT reflow processes. As with other packages, the thermal profile for specific board locations must be determined. The BGA is qualified for up to three reflow cycles at 245° C peak (J-STD-020). The actual temperature used in the reflow oven is a function of:

- Board density
- Board geometries
- Component location on the board
- Size of surrounding components
- Component mass
- Furnace loading
- Board finish
- Solder paste types

It is recommended that the temperature profile be validated at the ball location of the BGA as well as several other locations on the PCB surface.

Solder Ball Collapse

To produce the optimum solder joint, it is important to understand the amount of collapse of the solder balls, and the overall shape of the joint. These are a function of:

- The diameter of the package solder ball via.
- The volume and type of paste screened onto the PCB.
- The diameter of the PCB land.
- The board assembly reflow conditions.
- The weight of the package.

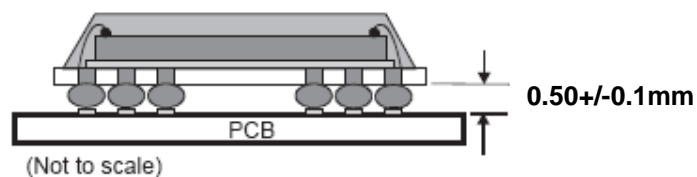

Controlling the collapse, and thus defining the package standoff, is critical to obtaining the optimum joint reliability. Generally, a larger standoff gives better solder joint fatigue strength, but this should not be achieved by reducing the board land diameter. Reducing the land diameter will increase the standoff, but will also reduce the minimum cross-section area of the joint. This, in turn, will increase the maximum shear force at the PCB side of the solder joint. Therefore, a reduction of land diameter will normally result in a worse fatigue life, and should be avoided unless all the consequences are well understood



3.6.1 For Pb Free paste reflow

A DOE (design of experiment) was performed to assemble the board under different assembly conditions.

3.6.1.1 Assembly build matrix

PCBA S/N	Packages per Board	Stencil Parameters	Reflow Atmosphere	Solder Alloy
01	4	5-mil Thick, 0.6mm Diameter Aperture	Air	SAC305
02	4	5-mil Thick, 0.6mm Diameter Aperture	Nitrogen	SAC305
03	4	4-mil Thick, 0.6mm Square Aperture	Air	SAC305
04	4	4-mil Thick, 0.6mm Square Aperture	Nitrogen	SAC305

3.6.1.2 Board properties

- 228.6 mm x 63.7 mm
- 3.7 mm thick
- 8 Layers
- OSP finish over Cu
- 0.45mm Pad Size
- NSMD pad
- 4 components per board



3.6.1.3 Package information:

- 27 mm x 27 mm
- 2.48 mm thick
- 1.0 mm pitch
- 456 balls
- SAC305 solder ball

3.6.1.4 Thermocouple locations:

- U4 Bottom Right Solder Joint
- U4 Center Solder Joint
- U4 Top Left Solder Joint
- U1 Top Right Solder Joint
- U1 Center Solder Joint
- U1 Bottom Left Solder Joint
- PCB

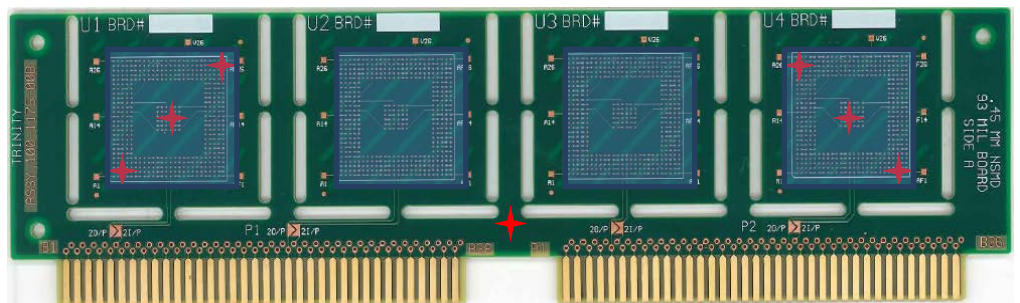

★: Thermocouples were attached to the solder joint through the other side of the board by drilling through the PCB. Then the components were placed on the board.



3.6.1.5 Lead free reflow profile for lead free components using lead free solder paste

An actual reflow profile using no clean paste that produce good board level reliability result.

Setpoints (Celsius)										
Zone	1	2	3	4	5	6	7	8	9	10
Top	140	150	160	175	195	205	245	255	295	285
Bottom	140	150	160	175	195	205	245	255	295	285

Conveyor Speed (inch/min): 27.0

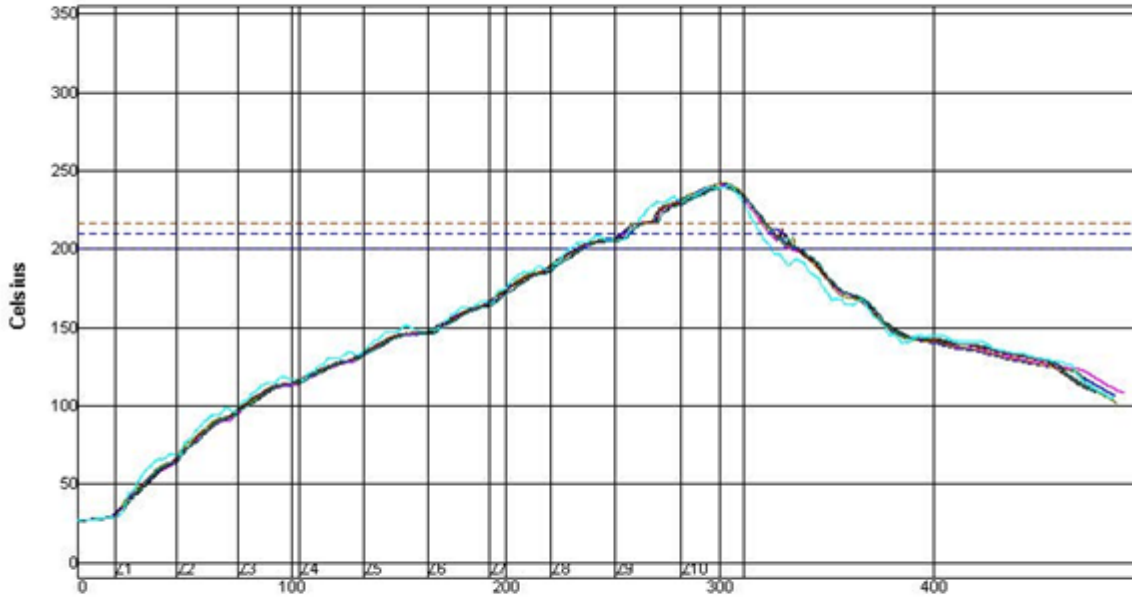

	Seconds					
	PWI= 69%	Soak Time 200-210C		Peak Temp		Tot Time /217C
U4-BOTTOM RIGHT	22.31	-54%	240.62	12%	56.05	-26%
U4-CENTER	21.57	-69%	241.90	38%	57.97	-14%
U4-TOP LEFT	22.53	-49%	242.28	46%	56.19	-25%
U1-TOP RIGHT	22.59	-48%	240.11	2%	55.00	-33%
U1-CENTER	21.71	-66%	240.06	1%	54.71	-35%
U1-BOTTOM LEFT	22.56	-49%	239.78	-4%	51.82	-55%
PCB	27.39	46%	241.22	24%	54.79	-35%
Delta	5.82		2.50		6.15	



3.6.2 Reflow profile for PbSn components using PbSn solder paste

The reflow peak temperature should be kept in the 215°C to 225°C range. An actual reflow profile used to produce good board level reliability result is shown below (no clean paste):

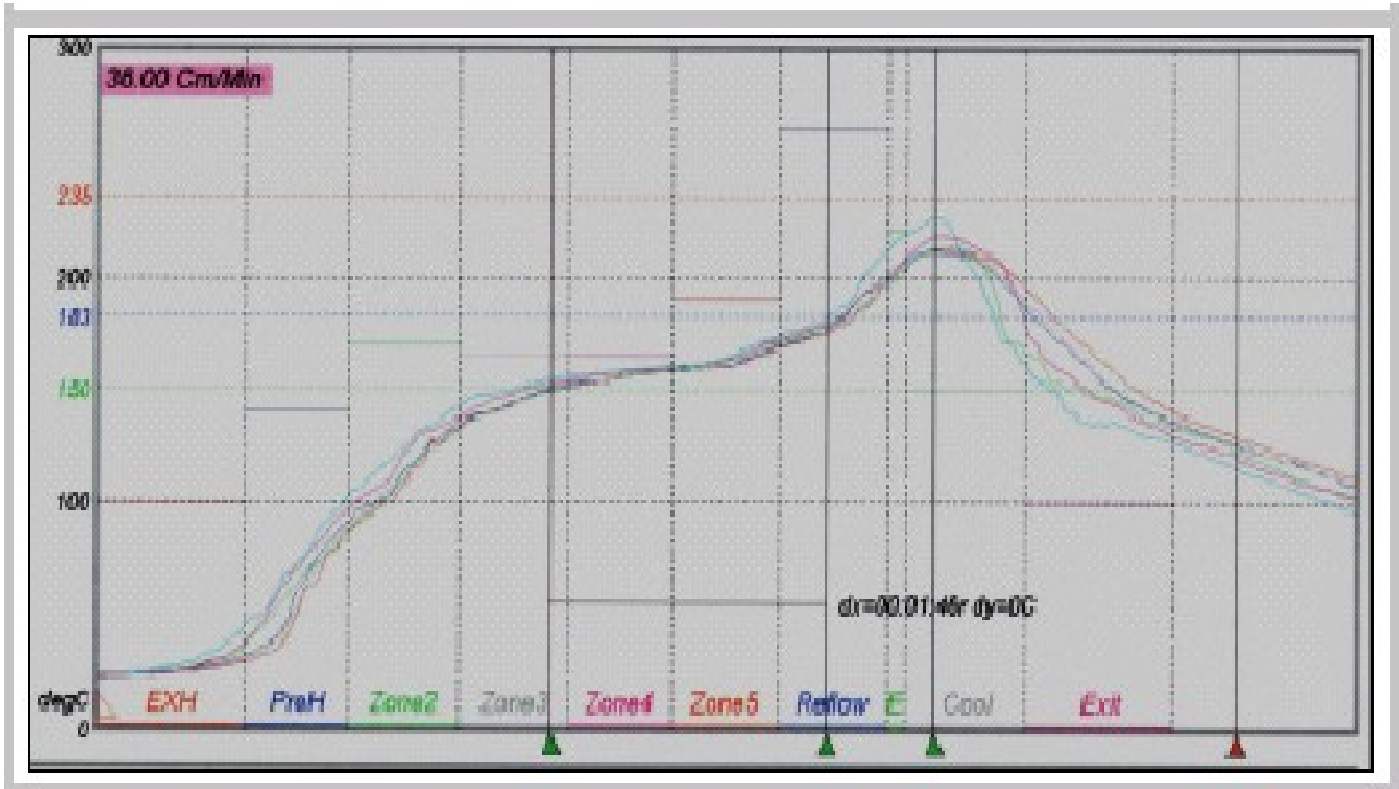

PbSn Reflow Profile:

Time between 150°C – 170°C: 100 sec

Time above 183°C: 60 sec

Peak Temp: 220°C



4.0 REPLACEMENT AND REWORK

Removing BGA packages involves heating the solder joints above the liquidus temperature of the solder and picking the part off the PCB when the solder melts. The quality of rework is controlled by directing thermal energy to solder without over-heating the adjacent components. Heating should occur in an encapsulated, inert, gas-purged environment where the temperature gradients do not exceed $\pm 5^{\circ}\text{C}$ across the heating zone using a convective bottom side pre-heater to maximize temperature uniformity. If possible, the PCB area should be preheated through the bottom side of the board, to 100°C before heating the BGA to ensure a controlled process. Interchangeable nozzles designed with different geometries will accommodate different applications to direct the airflow path. Once the liquidus temperature is reached, the nozzle vacuum is automatically activated and the component is removed.

4.1 SITE PREPARATION

It is recommended that the reflow profile used to reflow the BGA be as close to the PCB mount profile as possible. Preheat from the bottom side of the board is recommended where possible. Once the liquidus temperature is reached, the solder will reflow and the BGA will self-align.

4.2 COMPONENT PLACEMENT

Most BGA rework stations will have a pick and place feature for accurate placement and alignment. Manual pick and place, with only eyeball alignment, is not recommended. It is difficult to achieve consistent placement accuracy.

4.3 COMPONENT REFLOW

It is recommended that the reflow profile used to reflow the BGA be as close to the PCB mount profile as possible. Preheat from the bottom side of the board is recommended where possible. Once the liquidus temperature is reached, the solder will reflow and the BGA will self-align.

5.0 Reliability

Reliability is one of the first questions designers ask about any new packaging technology. They want to know how well the package will survive handling and assembly operation, and how long it will last on the board. The elements of package reliability and system reliability, while related, focus on different material properties and characteristics and are tested by different methods.

Package reliability focuses on materials of construction, thermal flows, material adherence/ delamination issues, resistance to high temperatures, moisture resistance and ball/stitch bond reliability. Thorough engineering of the package is performed to prevent delamination caused by the interaction of the substrate material and the mold compound. TI subjects each PBGA to rigorous qualification testing before the package is released to production.



Package-Level Reliability Test Results				
	<i>PinPkg</i>	<i>376ZDW</i>	<i>256ZDH</i>	<i>388ZDS</i>
	<i>PkgSize (mm)</i>	<i>23x23</i>	<i>17x17</i>	<i>27x27</i>
	<i>Die (mm)</i>	<i>8.64x8.44</i>	<i>5.13x4.67</i>	<i>6.41x6.54</i>
	<i>Level</i>	<i>4</i>	<i>3</i>	<i>4</i>
Test Environments				
<i>THB, 85RH/85°C</i>	<i>168 hrs</i>	<i>0/26</i>	<i>0/78</i>	<i>na</i>
	<i>300 hrs</i>	<i>0/26</i>	<i>na</i>	<i>na</i>
	<i>600hrs</i>	<i>0/26</i>	<i>0/78</i>	<i>na</i>
	<i>1000hrs</i>	<i>0/26</i>	<i>0/78</i>	<i>na</i>
<i>uHAST,85RH/110°C</i>	<i>96 hrs</i>	<i>0/77</i>	<i>0/78</i>	<i>0/78</i>
	<i>192 hrs</i>	<i>0/77</i>	<i>0/78</i>	<i>0/78</i>
	<i>264 hrs</i>	<i>0/77</i>	<i>0/78</i>	<i>0/78</i>
<i>TC, -55/125°C</i>	<i>100cyc</i>	<i>0/77</i>	<i>0/78</i>	<i>0/78</i>
	<i>500cyc</i>	<i>0/77</i>	<i>0/78</i>	<i>0/78</i>
	<i>1000cyc</i>	<i>0/77</i>	<i>0/78</i>	<i>0/78</i>
	<i>2000cyc</i>	<i>0/77</i>	<i>na</i>	<i>0/78</i>
<i>TS, -55/125°C</i>	<i>200cyc</i>	<i>0/77</i>	<i>0/26</i>	<i>0/78</i>
	<i>500cyc</i>	<i>0/77</i>	<i>0/26</i>	<i>0/78</i>
	<i>1000cyc</i>	<i>0/77</i>	<i>na</i>	<i>0/78</i>
<i>HTOL, 125°C</i>	<i>168cyc</i>	<i>0/77</i>	<i>na</i>	<i>na</i>
	<i>300cyc</i>	<i>0/77</i>	<i>na</i>	<i>na</i>
	<i>600cyc</i>	<i>0/77</i>	<i>na</i>	<i>na</i>
	<i>1000cyc</i>	<i>0/77</i>	<i>na</i>	<i>na</i>
<i>Bake, 150°C</i>	<i>168hrs</i>	<i>na</i>	<i>0/78</i>	<i>0/78</i>
	<i>300hrs</i>	<i>na</i>	<i>na</i>	<i>0/78</i>
	<i>500hrs</i>	<i>na</i>	<i>0/78</i>	<i>0/78</i>
	<i>1000hrs</i>	<i>na</i>	<i>0/78</i>	<i>0/78</i>



Board-level Reliability Summary

Package Information				Test Conditions	Sample Size/Failures			
					Test Cycle Requirements		Test Cycle Extended range	
Package	Pkg Size (mm)	Pitch (mm)	Die (mm)	Temp Cyc (degC)	500	1000	1500	2000
256ZKB	17X17	1	6.949 X 5.820	-40/125	38/0	38/0	38/0	38/0
456ZXZ	27X27	1	8.500 X 8.800	-40/125	32/0	32/0	32/0	32/0
640ZKK	23X23	0.8	8.010 X 8.098	-40/125	42/0	42/0	42/0	42/0

6.0 Packing and Shipping

PBGA packages are shipped in trays or “Tape-and-Reels”.

6.1 Trays

Thermally resistant plastic trays are used to ship these packages. Each family of parts with the same package outline has its own individually designed tray. The trays are designed to be used with pick-and-place machines.

Typical tray details

Table with number of units per tray.

<i>Package Size, mm</i>	<i>Matrix</i>	<i>Units/Tray</i>	<i>Units/Box</i>
<i>17 x 17</i>	<i>6 x 15</i>	<i>90</i>	<i>900</i>
<i>19 x 19</i>	<i>6 x 14</i>	<i>84</i>	<i>840</i>
<i>23 x 23</i>	<i>5 x 12</i>	<i>60</i>	<i>600</i>
<i>27 x 27</i>	<i>4 x 10</i>	<i>40</i>	<i>200</i>
<i>31 x 31</i>	<i>3 x 9</i>	<i>27</i>	<i>135</i>
<i>35 x 35</i>	<i>3 x 8</i>	<i>24</i>	<i>120</i>



6.2 Tape-and-Reel

Pkg Group	Package	Pkg Size	Qty per reel	Reel							
				WIDTH	DIAMETER	HUB					
PBGA 256	GDH	17x17	750	32mm	13 in	4 in					
PBGA 256	ZKB										
PBGA 256	ZEP										
PBGA 491	ZCN										
PBGA 491	ZDN										
PBGA 256	ZFE										
PBGA 208	ZFE										
PBGA 1088	CYL										
PBGA 208	ZKB										
PBGA 754	AAN										
PBGA 256	ZDH										
PBGA 208	ZDH										
PBGA 289	ZEL						19x19	500	32mm	13 in	4 in
PBGA 289	GDY										
PBGA 289	ZDY										
PBGA 484	ZVK										
PBGA 288	GDQ										
PBGA 324	GDU	23X23	250	44mm	13 in	7 in					
PBGA 324	GDW										
PBGA 324	ZKD										
PBGA 376	ZKD										
PBGA 324	ZDU										
PBGA 768	ZDU										
PBGA 640	ZKK										
PBGA 324	ZDW										
PBGA 376	ZDU										
PBGA 376	ZDW										
PBGA 388	ZDW										
PBGA 420	ZDQ										
PBGA 484	ZDU										
PBGA 376	ZKC										
PBGA 324	ZKC										
PBGA 484	ZER										
PBGA 484	ZDW										
PBGA 256	GFN						27x27	250	44mm	13 in	6 in
PBGA 256	ZFN										
PBGA 272	GDP										
PBGA 272	GFN										
PBGA 584	ZEQ										
PBGA 580	ZEQ										
PBGA 316	GFN										
PBGA 352	GPC										
PBGA 352	ZPC										
PBGA 388	GDS										
PBGA 388	GED										
PBGA 388	GPC										
PBGA 388	ZDS										
PBGA 388	ZED										
PBGA 388	ZPC										
PBGA 456	GXF										
PBGA 456	ZXF										
PBGA 484	ZED										
PBGA 520	ZXF										
PBGA 676	GPY	35x35	250	56mm	13 in	6 in					
PBGA 352	GFT										
PBGA 352	ZFT										
PBGA 388	GFW										
PBGA 388	GFT										
PBGA 420	GDC										
PBGA 474	GPJ										
PBGA 520	GPJ										
PBGA 580	GPA										
PBGA 624	GPA										
PBGA 624	ZPA										
PBGA 676	GXD										
PBGA 676	ZXD										
PBGA 680	GPA										
PBGA 680	ZPA										
PBGA 680	ZWZ										
PBGA 976	ZWZ										
PBGA 729	GXB										

7.0 Sockets



7.1 PBGA Test Contactor Pin and Ball Contact

Typical testing of TI pbga packages is done through the use of a pogo pin style contactor. See below for an image of an actual test socket and contactor. Also note the typical witness marks on the ball after testing.

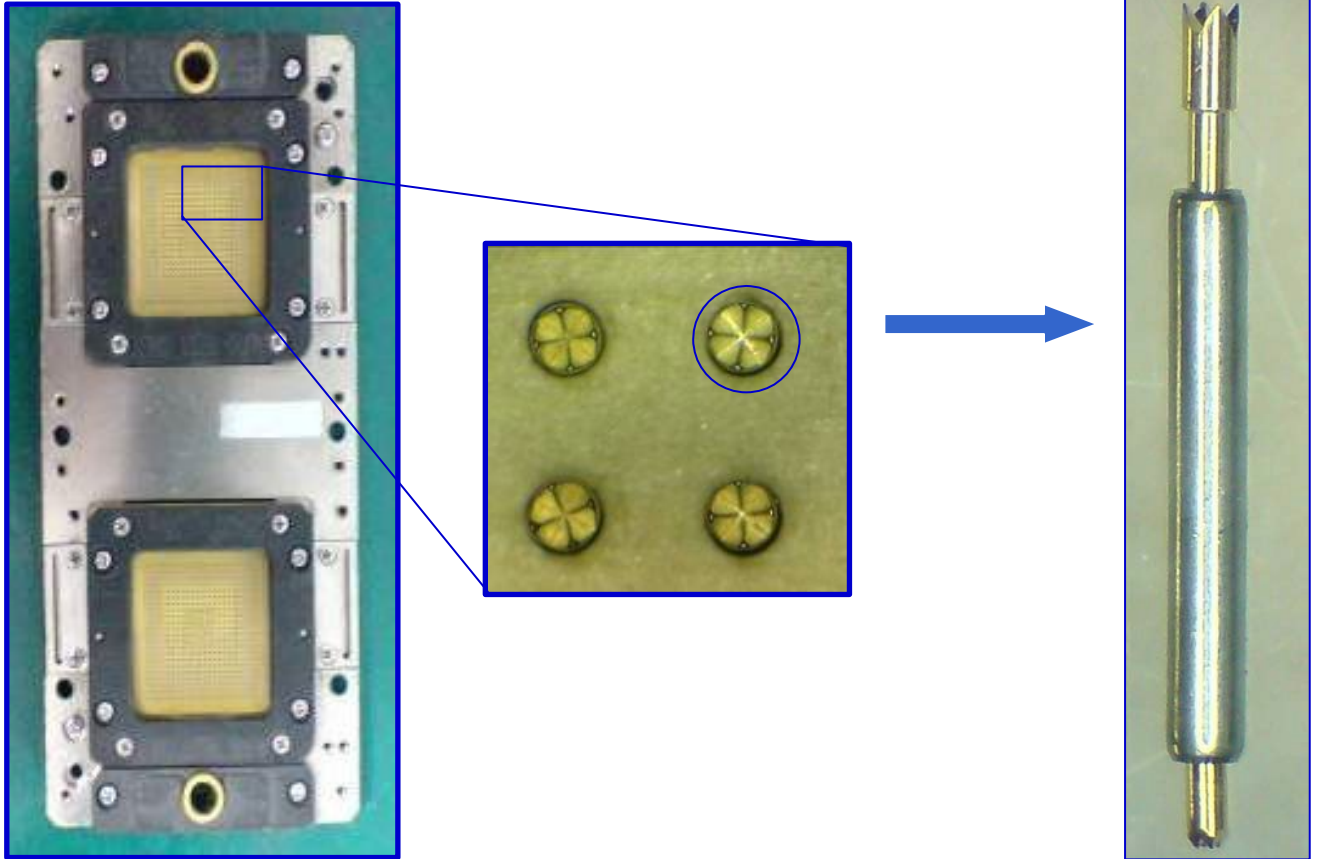

Contactor for 0.8/1.0mm pitch PBGA (23X23)

Pogo Pin

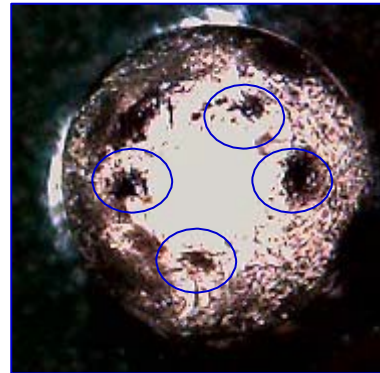
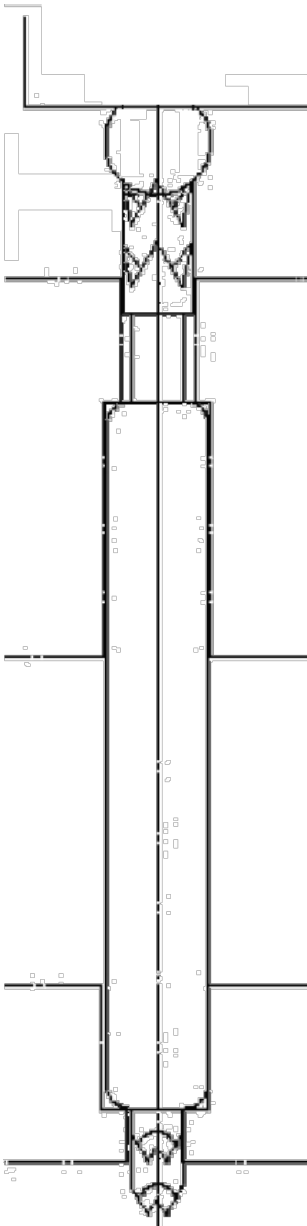

- **Pin – Ball Contact is pricking**
- **Expected toolmark - Crown Tip marks on balls.**



7.2 PBGA Burn- In Pin and Ball Contact

A pinch style contact has been used extensively for contacting solder balls in conventional BGAs and is the proposed method for burn-in of these packages, providing the most reliable solution with less ball deformation at an affordable cost. Further information on the availability of these sockets can be obtained from your local TI Field Sales representative.

Picture below showing a typical Texas Instruments burn-in socket and pins

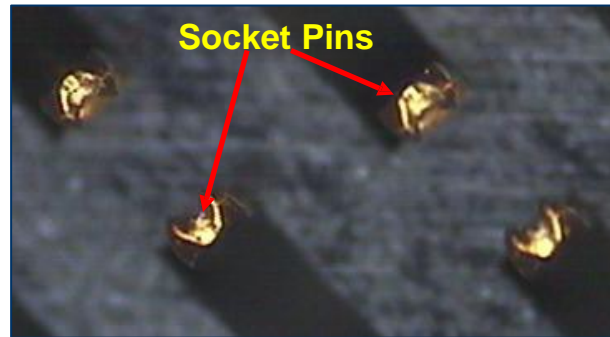
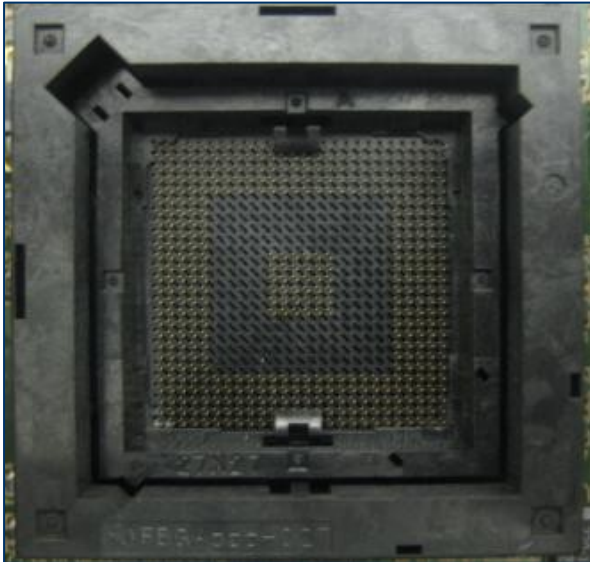

Actual Socket Pin Magnification

PBGA socket

Socket Pin Package: 456 ZXF

The contact is designed to grip the solder ball with a pinching action. This not only provides electrical contact to the solder ball but also helps retain the package in the socket. Each contact incorporates two beams that provide an oxide-piercing interface with the sides of the balls above the central area—the equator. No contact is made on the bottom of the solder ball so the original package planarity specifications are unchanged. The contact is shown below:



Horizontal Cross Section:

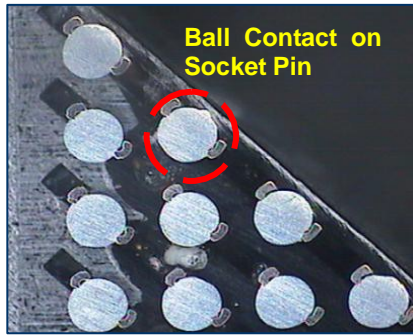

Cross-section Magnification:

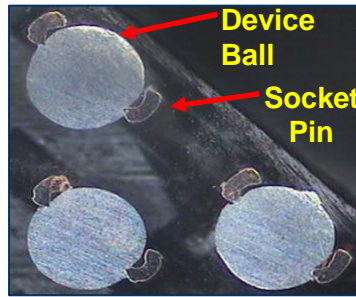

Result: *Good*
Contact between the ball and the socket pin

Vertical Cross Section:

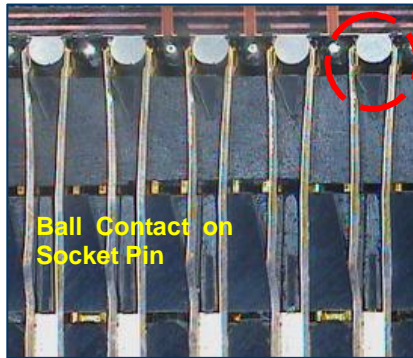

Cross-section Magnification:

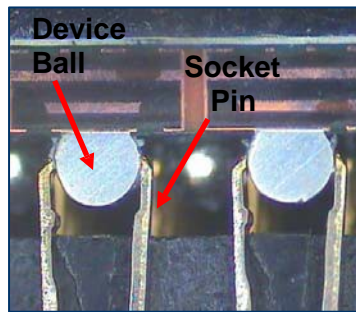

Remarks: *Good*
Ball Contact on the socket pin; No Abnormalities seen inside the socket

The witness marks left on the solder ball from the contact are shown below. There is no damage to the bottom of the ball and typical pin contact signature is seen in the ball marking magnification photograph below.

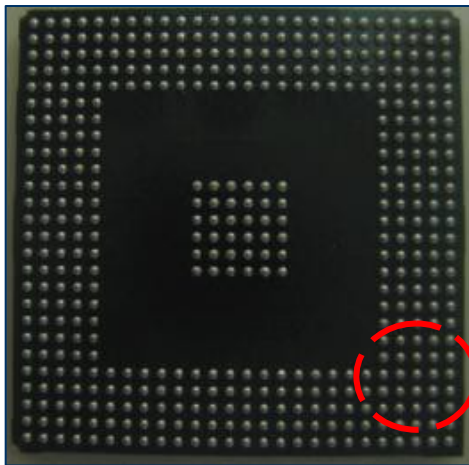

Sample PBGA Device

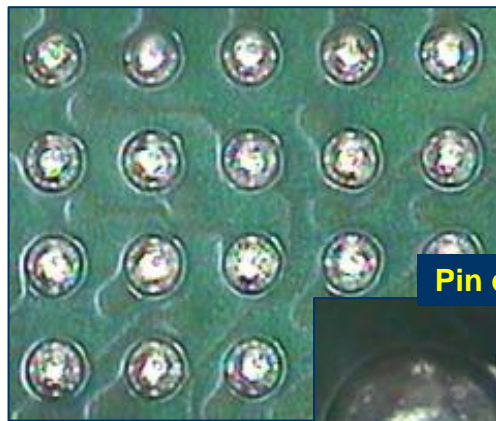

Ball Marking Magnification

Frequently Asked Questions

A.1 Package Questions

Q Do the solder balls come off during shipping?

A No, this has never been observed. The balls are inspected for coplanarity, diameter, and other physical properties prior to packing for shipment. Because solder is used during the ball-attachment process, uniformly high ball-attachment strengths are developed. Also, the ball-attachment strength is monitored frequently in the assembly process to prevent ball loss from vibration and other shipping forces.

Q Is package repair possible? Are tools available?

A Yes, some limited package repair is possible, and there are some semiautomatic M/C tools available. However, TI does not specify the reliability of repaired packages.

A.2 Assembly Questions

Q What alignment accuracy is possible?

Alignment accuracy for the package is dependent upon board-level pad tolerance, placement accuracy, and solder ball position tolerance. Nominal ball position tolerances are specified at $\pm 100 \mu\text{m}$. These packages are self-aligning during solder reflow, so final alignment accuracy may be better than placement accuracy.

Q Can the solder joints be inspected after reflow?

A No final in-line inspection is necessary. Some customers are achieving satisfactory results during process set-up with lamographic X-ray techniques.

Q Are there specific recommendations for SMT processing?

A SMT processing must match the recommended reflow profile.

Q Can the boards be repaired?

A TI strongly recommends that removed packages be discarded.

Q What size land diameter for these packages should I design on my board?

A Land size is the key to board-level reliability, and Texas Instruments strongly recommends following the design rules included in this document.

----END APPLICATION NOTE----

Revision History

Rev B. August 2015	Changed the "Optium Land Configurations" table on page 6
--------------------	--

IMPORTANT NOTICE

Texas Instruments Incorporated and its subsidiaries (TI) reserve the right to make corrections, enhancements, improvements and other changes to its semiconductor products and services per JESD46, latest issue, and to discontinue any product or service per JESD48, latest issue. Buyers should obtain the latest relevant information before placing orders and should verify that such information is current and complete. All semiconductor products (also referred to herein as "components") are sold subject to TI's terms and conditions of sale supplied at the time of order acknowledgment.

TI warrants performance of its components to the specifications applicable at the time of sale, in accordance with the warranty in TI's terms and conditions of sale of semiconductor products. Testing and other quality control techniques are used to the extent TI deems necessary to support this warranty. Except where mandated by applicable law, testing of all parameters of each component is not necessarily performed.

TI assumes no liability for applications assistance or the design of Buyers' products. Buyers are responsible for their products and applications using TI components. To minimize the risks associated with Buyers' products and applications, Buyers should provide adequate design and operating safeguards.

TI does not warrant or represent that any license, either express or implied, is granted under any patent right, copyright, mask work right, or other intellectual property right relating to any combination, machine, or process in which TI components or services are used. Information published by TI regarding third-party products or services does not constitute a license to use such products or services or a warranty or endorsement thereof. Use of such information may require a license from a third party under the patents or other intellectual property of the third party, or a license from TI under the patents or other intellectual property of TI.

Reproduction of significant portions of TI information in TI data books or data sheets is permissible only if reproduction is without alteration and is accompanied by all associated warranties, conditions, limitations, and notices. TI is not responsible or liable for such altered documentation. Information of third parties may be subject to additional restrictions.

Resale of TI components or services with statements different from or beyond the parameters stated by TI for that component or service voids all express and any implied warranties for the associated TI component or service and is an unfair and deceptive business practice. TI is not responsible or liable for any such statements.

Buyer acknowledges and agrees that it is solely responsible for compliance with all legal, regulatory and safety-related requirements concerning its products, and any use of TI components in its applications, notwithstanding any applications-related information or support that may be provided by TI. Buyer represents and agrees that it has all the necessary expertise to create and implement safeguards which anticipate dangerous consequences of failures, monitor failures and their consequences, lessen the likelihood of failures that might cause harm and take appropriate remedial actions. Buyer will fully indemnify TI and its representatives against any damages arising out of the use of any TI components in safety-critical applications.

In some cases, TI components may be promoted specifically to facilitate safety-related applications. With such components, TI's goal is to help enable customers to design and create their own end-product solutions that meet applicable functional safety standards and requirements. Nonetheless, such components are subject to these terms.

No TI components are authorized for use in FDA Class III (or similar life-critical medical equipment) unless authorized officers of the parties have executed a special agreement specifically governing such use.

Only those TI components which TI has specifically designated as military grade or "enhanced plastic" are designed and intended for use in military/aerospace applications or environments. Buyer acknowledges and agrees that any military or aerospace use of TI components which have **not** been so designated is solely at the Buyer's risk, and that Buyer is solely responsible for compliance with all legal and regulatory requirements in connection with such use.

TI has specifically designated certain components as meeting ISO/TS16949 requirements, mainly for automotive use. In any case of use of non-designated products, TI will not be responsible for any failure to meet ISO/TS16949.

Products

Audio	www.ti.com/audio
Amplifiers	amplifier.ti.com
Data Converters	dataconverter.ti.com
DLP® Products	www.dlp.com
DSP	dsp.ti.com
Clocks and Timers	www.ti.com/clocks
Interface	interface.ti.com
Logic	logic.ti.com
Power Mgmt	power.ti.com
Microcontrollers	microcontroller.ti.com
RFID	www.ti-rfid.com
OMAP Applications Processors	www.ti.com/omap
Wireless Connectivity	www.ti.com/wirelessconnectivity

Applications

Automotive and Transportation	www.ti.com/automotive
Communications and Telecom	www.ti.com/communications
Computers and Peripherals	www.ti.com/computers
Consumer Electronics	www.ti.com/consumer-apps
Energy and Lighting	www.ti.com/energy
Industrial	www.ti.com/industrial
Medical	www.ti.com/medical
Security	www.ti.com/security
Space, Avionics and Defense	www.ti.com/space-avionics-defense
Video and Imaging	www.ti.com/video

TI E2E Community

e2e.ti.com