

C2000™ MCUs enable the next generation of low-cost, dual-axis servo drives



Brian Fortman
C2000™ Marketing
Texas Instruments

As factory automation continues its rapid adoption of precision motion control in industrial machines, the number of servo motors and servo drives used in these applications is skyrocketing.

Some analysts have characterized the servo drive market as “unbounded” as the applications expand. This is not surprising as previous manual processes become automated: the mechanical power capability of today’s servo motors can be a practical replacement for pneumatic and hydraulic-based actuation.

Motion control and servo drive advancements – enabled by servo drive and servo motor hardware enhancements such as the transition of inverter switches away from insulated gate bipolar transistors (IGBTs) toward higher-speed gallium nitride (GaN) and higher-power silicon carbide (SiC) technology – remain essential for competing in the global economy. The market dynamics also remain extremely competitive. Suppliers seek advantages for their servo drive lineups in system-level criteria including control performance, connectivity, ease of use and cost.

Higher performance and higher precision control will always be sought after for some machine functions. However, given the strides already made in digital drive control performance, the greater challenge today is the cost of “standard” motion performance for a machine’s application, rather than the maximum attainable control bandwidth for speed and position loops. And since most industrial automation machines have multiple motor axes of control, a better metric to consider is the cost-per-axis for such performance. Since some drive electronics functions (and therefore their costs) can be shared across axes, in some cases it makes sense to consider servo drives that can support two axes instead of the more traditional single motor.

With the release of the F28004x and F28002x series of C2000™ microcontrollers (MCUs), Texas Instruments (TI) has enabled a new value point for dual-axis drives that also delivers very robust motion-control performance. The value comes not only from the achievable control performance and ability to drive two motors concurrently, but also from the high degree of on-chip integration of other key electronic system functions.

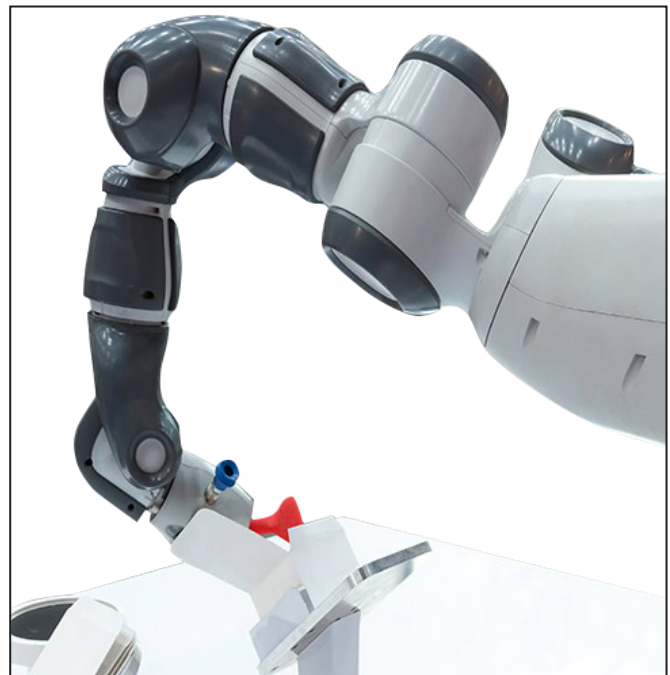

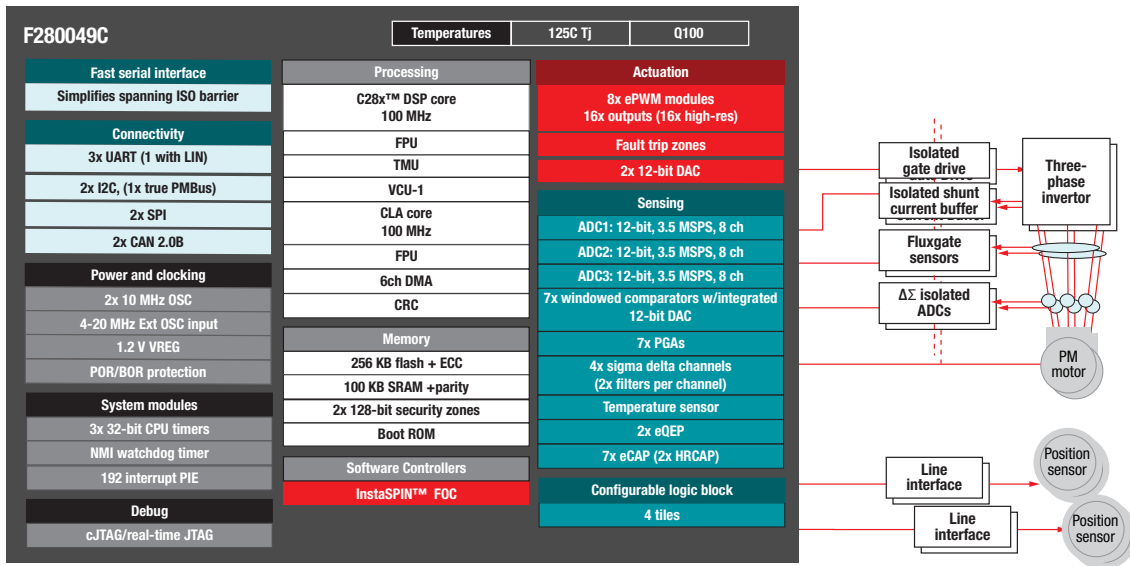

Figure 1. F280049C MCU in a dual-axis configuration.

In this white paper, I will show the superset F28004x features that enable support for dual axes, with control technology that delivers unprecedented motion control performance and the opportunity to further reduce the bill of materials by using both new and legacy features integrated onto a real-time controller.

Integrated peripherals support dual-axis drives

The F28004x (TMS320F280049C) series is a scaled down version of the popular F2837x (TMS320F28379D) series. TI carried forward the accelerator and peripheral enhancements and added a few additional features for AC drives and servo applications, as shown in Figure 1.

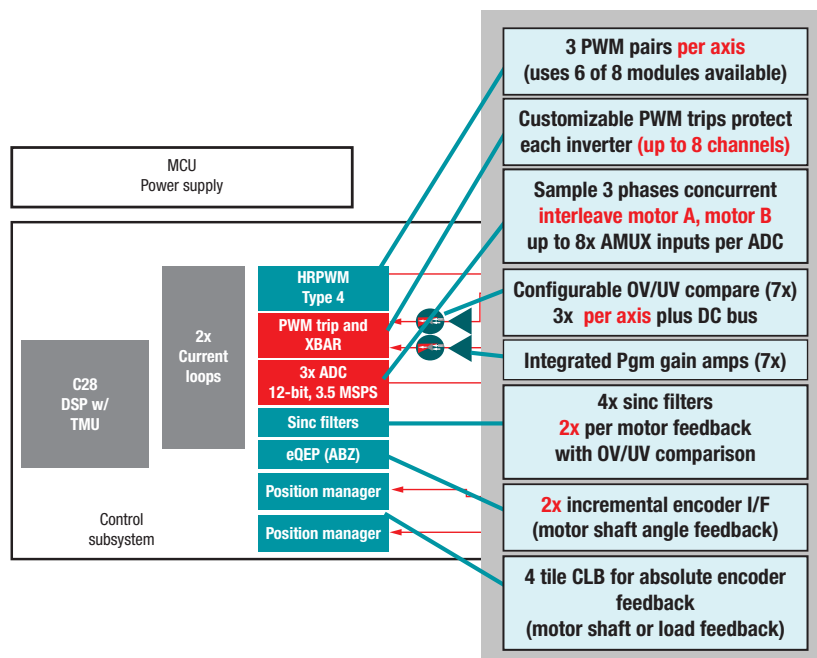

Figure 2. The key input/output (I/O) features supporting dual-axis control.

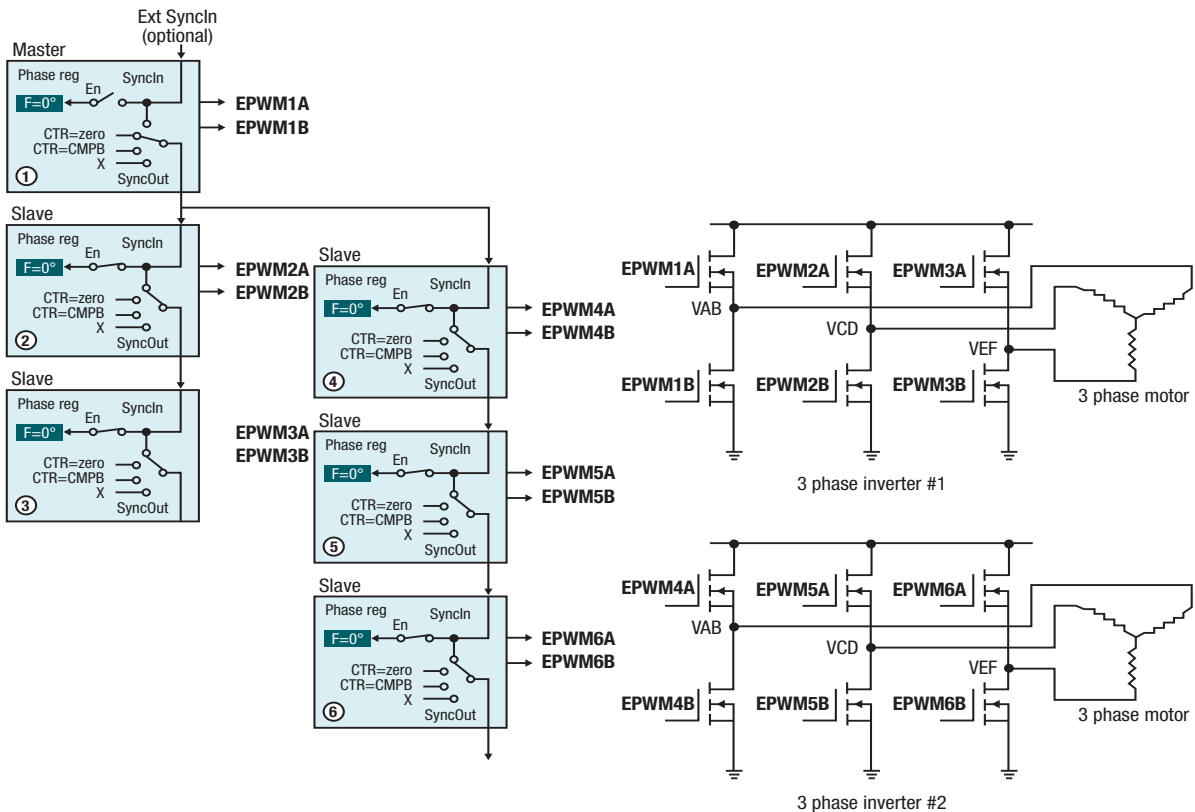

Figure 3. Control of a dual three-phase inverter stage common in motor control.

Let's have a closer look at how the configuration of the F28004x series enables the control of two servo motors concurrently. Several of the key features supporting dual axis applications are highlighted in Figure 2 below.

Inverter actuation through C2000 fourth-generation ePWM modules

A common two-level three-phase inverter used for a permanent magnet synchronous motor (PMSM) or an alternating current induction (ACI) motor requires two switches in a half-bridge configuration on each of the three legs.

The pulse-width modulators (PWMs) act as complementary pairs to ensure the correct management of the high- and low-side switches of one leg.

High-performance deadband features of the PWMs are especially helpful here to avoid shoot-through.

Each enhanced PWM (ePWM) module on the F28004x device contains a pair of complementary PWM generating timers. When supporting two

three-phase inverters, as shown in Figure 3, you can see that only six of the PWM modules are required: the F28004x still has two PWM pairs available. Wouldn't these two pairs be particularly handy if the F28004x was also applying its control capability to a power factor correction (PFC) circuit that was generating the high-voltage DC bus for the inverter? What if you applied the extra PWMs to the generation of precision clocking in support of position manager solutions for absolute encoder interfaces? Or possibly for braking functions?

With a 100MHz instruction execution frequency, or SYSCLK, the F28004x can update the PWM time-base settings at that frequency for a PWM resolution of 10ns. If you need more precise control in higher-speed switching scenarios, a 150ps high-resolution step is available when using the high-resolution PWM (HRPWM) features. With the advent of GaN and SiC inverter switches featuring very low 12.5ns or smaller deadband periods, the high-resolution deadband capabilities of HRPWMs helps dramatically minimize phase-voltage

ringing, sinusoidal distortions and electromagnetic interference.

Customizable inverter protection through flexible PWM trip capability

Placing the PWM outputs into a known protected state using the ePWM trip-zone capability protects the inverter. This feature can be particularly useful if you need a torque-off condition when using the trip in one-shot mode.

Applying the supported cycle-by-cycle tripping mechanisms may allow even more sophisticated ways to keep the equipment running without completely shutting down. In addition, there are multiple potential sources for driving a PWM trip. These sources include an external signal for on-chip qualification and inversion as well as integrated, high-speed analog comparators and on-chip sigma-delta filter comparators. As many as eight channels of trip input and PWM crossbar resources are available, so it's possible to reserve four channels of trips for each of the two inverters. Every F28004x PWM trip module also includes a selection of Boolean logic configurations in the digital compare module that can further qualify the trip action.

High-performance analog conversion of three phases concurrently

Reducing the overall current-loop time is critical for high-performance servo control. The analog-to-digital (ADC) conversion time has a significant impact on the total current-loop time. It would seem like sampling each motor-phase current on two motors would dominate the current-loop time. However, the high-performance ADCs on the F28004x include many features that minimize the impact on a dual-motor, dual-current loop.

For example, the F28004x has three ADCs that can use a common start-of-conversion trigger, enabling the measurement of all three phases at precisely the

same time. Only two ADCs would require additional sampling, or the CPU would have to algorithmically derive the third phase value, potentially introducing errors in the control and increasing the latency in CPU field-oriented control (FOC) processing. The three 12-bit ADCs can complete the sampling and conversions concurrently in only 290ns.

Also consider that each of the three F28004x ADCs deliver these 3.5MSPS while also delivering 11.1 effective number of bits (ENOB) of dynamic range.

Because of the flexible start-of-conversion triggering ability, the same three ADCs can alternately sample the three phases of each motor's current. By suitably staggering the start of conversion for each motor, the time it takes to close the current loop for a dual-axis system is not double the length of time needed to complete a single current loop. In fact, the loop time is the same, whether supporting single or dual axes.

As many as 21 analog multiplexed inputs

Each ADC has at least nine multiplexed analog input options on the 100-pin quad flat package (QFP) and at least four potential analog inputs on the 7mm-by-7mm 56-pin quad flat no-lead (QFN) package. This configuration provides flexibility to support the interleaved three-phase sampling of at least four different sets of current and/or voltage sensing, even on the tiniest device in the F28004x series, with several additional analog inputs for DC bus, temperature monitoring and perhaps other less time-critical signals.

Four sigma-delta filters

The F28004x supports dual axes in high voltage systems as well. When delta-sigma modulators are used to sense motor-phase currents, the resulting digital signals cross the air gap to the cold-side where they must be filtered for use in the control

algorithms. TI's [AMC130x](#) delta-sigma modulators are a good option but still require filtering to use them for motion control. Like previous MCUs, the F28004x series features digital sinc filtering on-chip to support these external ADCs. In fact, with four total channels of the digital filters on-chip, it's possible to route two phases of the sampled current information of each motor directly to the F28004x. In this case, the CPU can use the two input phases to algorithmically derive the third phase values. Recall that each sigma-delta input channel includes a parallel digital comparison path that when configured can trip the PWMs in overcurrent situations.

Motor shaft position feedback through two eQEPs

Whether it's a dual-channel motor-shaft position or dual channels of absolute encoder load-angle feedback, the F28004x series can decode all four feedback paths simultaneously. Many servo motors today come with built-in incremental position encoders, commonly referred to as ABZ encoders by the names of their output signals, A, B and Z, to feed back the motor-shaft angle once you know the index. Because the F28004x includes two standard enhanced quadrature encoder peripherals (eQEPs) on-chip, handling dual ABZ interfaces is not a problem. The trend in the industry is to move to absolute encoders and avoid the indexing problem altogether. Absolute encoders are especially helpful for measuring the load angle and a dual-axis drive will need to support two interfaces to absolute encoders.

Dual feedback paths of load positions through absolute encoder protocols

The position manager solutions for absolute encoders leverage a peripheral block on the F28004x and other C2000 MCUs called the configurable logic block (CLB). The CLB works with other peripherals on-chip to create more valuable functions that otherwise might require external logic devices such as a complex programmable logic device (CPLD) or a field-programmable gate array (FPGA).

In position manager solutions, coupling the CLB with a serial port creates solutions for EnDat2.2, bidirectional/serial/synchronous (BiSS), Tamagawa T-format and other serial encoder standards. The CLB on the F28004x has enough capability to implement two channels of most protocols.

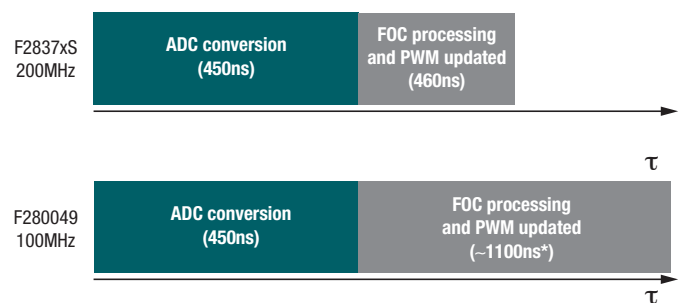

Figure 4. A comparison of FCL execution on the F2837x and F28004x.

Robust dual-axis current control performance with FCL

The fast current loop (FCL) time on a 200MHz F2837xS device has been measured at 910ns, from ADC sample to PWM update, and yielding a 5kHz current-loop control bandwidth from a 10kHz PWM carrier. Because of the similarities in architecture, CPU and peripherals between the F28004x and device, is not difficult to estimate the FCL time on the F28004x at 100MHz or a 10ns cycle time. While the FOC processing will double, the 12-bit ADC

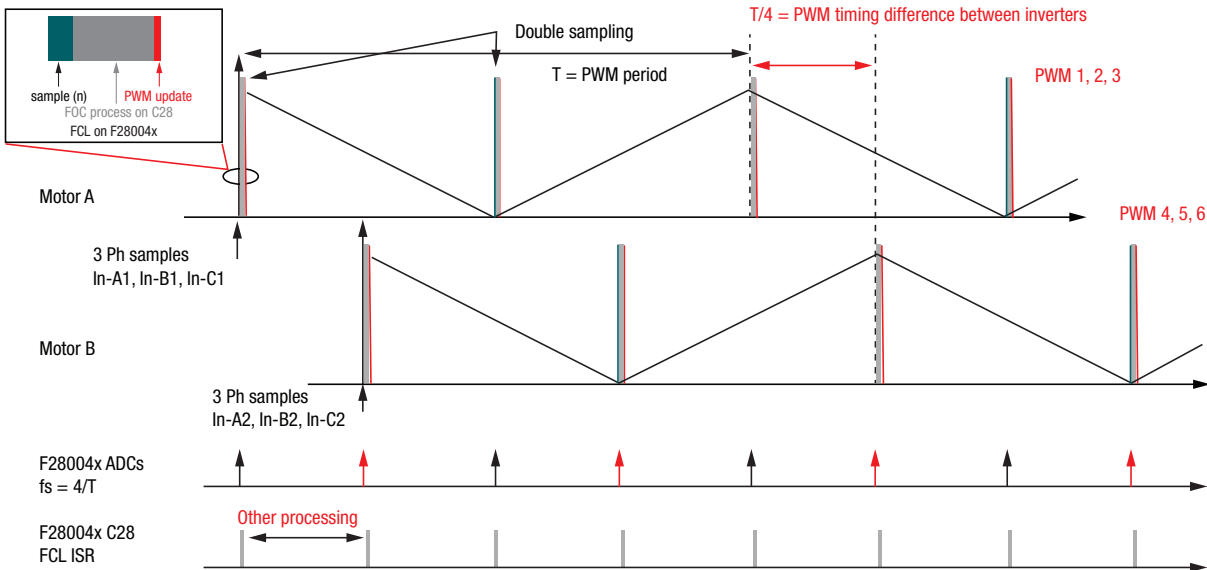

Figure 5. A comparison of FCL execution on the F2837x and F28004x.

conversion time will not change. See **Figure 4**.

For a single axis, you can estimate the FCL to complete in less than 1.6µs on the F28004x series, which is nearly a full microsecond faster than traditional current loops. Even on the lower-cost device, the closed loop current bandwidth provided by FCL remains at 5kHz on a 10kHz carrier.

However, this white paper is about using the F28004x in a dual-axis configuration. Previously, I described how the F28004x series has the peripheral capability to support two servo motors at the same time. If you assume that the ground plane of the control circuits is not shared with the ground planes of each of the inverter/motor axes, then it's possible for a single F28004x to run two independent FCLs in 1.6µs while still supporting the high-control bandwidth and double sampling of each axis.

The key lies in interleaving the ADC double sampling between each motor so that the sampling and subsequent FOC processing does not need to happen back to back. In order to maintain the goal of measuring the currents of each motor during voltage transitions, there must be a phase difference between the carriers driving each axis.

For example, if the motor B carrier lags motor A by a fixed 90 degrees, then the ADC sampling period is consistent across both motors but interleaved between them. Using two 100µs carriers, the ADCs can sample three phases of motor A at time zero, three phases of motor B at 25µs, a “double sample” of motor A at 50µs and a double sample of motor B at 75µs. See **Figure 5**.

Each ADC sample and conversion is followed by the C28x CPU performing the FOC algorithm and updating the PWMs. In this way, the sample-to-PWM update remains very consistent for each execution, whether it's the first or second sample of motor A or motor B.

Although using shared resources (the ADCs and the CPU, for example), there is no contention for these resources with this scheme. Each current-loop update – and there are four of them happening in one period, T – takes only 1.6µs. All of the performance benefits of FCL, like high control bandwidth and marginal modulation index (M-I) impact, still apply.

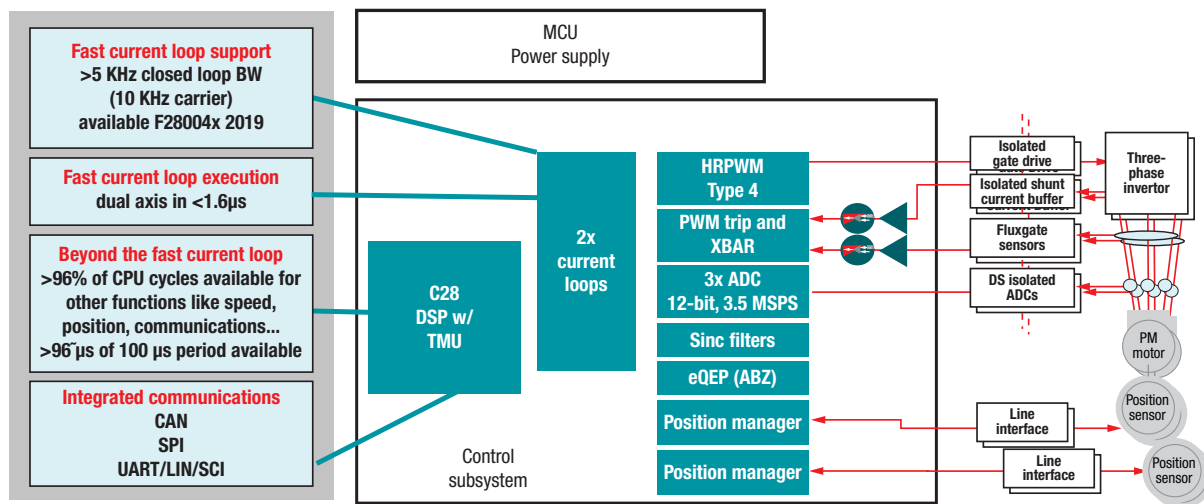

Figure 6. Dual FCL on the F28004x.

So both axes should operate with an modulation index of 93.6% and deliver 5kHz of closed-loop control bandwidth for a 10kHz PWM carrier frequency.

Figure 5 illustrates another important point as well. In every 100µs PWM period, the CPU executes the FOC for 1µs four times. So for other processing functions like the speed loop, position loop or perhaps some communication functions, over 90% of the CPU cycles remain available for use.

Estimates of FCL performance and CPU resource availability are shown in Figure 6.

On-chip support functions save system costs

Besides the performance that FCL can deliver and the breadth of control peripherals on-chip that make dual-axis control from a single MCU possible, the F28004x series also includes a number of capabilities that could be very beneficial to reduce development and bill-of-materials costs for an industrial drive.

Functional safety features

A variety of safety-related applications – including digital power, electric vehicles, industrial machinery, industrial processing, medical, automotive, rail and aviation – use SafeTI™ design packages

for functional safety applications. SafeTI control solutions help you get to market quickly with safety-critical systems targeting compliance to safety standards such as International Organization for Standardization (ISO) 26262 and International Electrotechnical Commission (IEC) 61508. The F28004x series is being offered with SafeTI quality-managed design packages for functional safety applications.

Basic communications ports

Even with dual-axis FCL execution, the C28 has plenty of bandwidth available to support additional software functions. Some of those functions might include communication to external systems like the power supply, human machine interface (HMI) or networking. The F28004x includes many of the standard communication ports in its peripheral mix, including Controller Area Network (CAN) 2.0b, universal asynchronous receiver transmitters (UARTs), Serial Peripheral Interface (SPI) and Inter-Integrated Circuit (I2C).

For richer HMI or broader communications support, especially for very flexible support of industrial Ethernet standards like EtherCAT and Profinet, you can use the F28004x SPI port to communicate with TI's Sitara™ AMIC110 multiprotocol processors.

FSI

The F28004x also introduces a new serial port from C2000 MCUs that could be very useful when expanding to more than two axes. The Fast Serial Interface (FSI) is a high-speed serial port supporting up to 200Mbps in each direction in three-wire mode, or 100Mbps each in two-wire mode. FSI is meant for use in a chip-to-chip configuration and you can daisy-chain multiple F28004x devices together.

The FSI can also support digital communication across a high-speed reinforced isolator like the ISO74xx family from TI, especially when your requirements include low latency, high bandwidth and low cost.

The F28004x series can serve as a real-time control-loop accelerator in certain servo system architectures that may need to use a larger microprocessor for motion planning, HMI or an advanced communications manager. The communication bus between the controller and processor could be a high-speed SPI or FSI. Because the communications are serial in nature, you benefit from the minimized board routing requirements and the reduced costs of signal isolation.

DC/DC core power-supply controller

For power and cost savings, designs using the F28004x can take advantage of the integrated 1.2V switching regulator (DC/DC) controller to generate the core voltage instead of using the on-chip low-dropout regulator. Compared to older Piccolo devices using an on-chip linear regulator, using the the DC/DC controller on the F28004x series can save over 60% of the power consumed.

Seven PGAs

Based on the precision requirements generally required in the current-sensing path of servo drive controllers, the integrated programmable gain

amplifiers (PGAs) on the F28004x series may not be the best solution. However, industrial servo drives certainly do have other analog sensing inputs for which you could apply the PGAs.

For example, the PGAs may be able to replace the signal-conditioning path that senses the DC bus supply to the inverter. In some cases, the PGAs may be also useful to condition or amplify temperature or other system-monitoring analog inputs. Some servo drives may include an analog input feature, for example, to sense a 4-20mA analog signal from other sensors or automation equipment. The programmable gain feature of the PGAs could be particularly helpful when gain control is necessary to improve the dynamic range of the input.

Buffered DACs

The F28004x has two buffered 12-bit digital-to-analog converters (DACs). The buffered DAC is a general-purpose DAC that can generate a DC voltage or AC waveforms such as sine waves, square waves or triangle waves. Software writes to the DAC value register can take effect immediately or synchronize with events triggered by the PWM.

A practical example of how to apply the DACs is to generate a bias to convert bipolar signals into acceptable ADC input levels. Another practical use is to use the DACs to represent an internal digital value for external analog monitoring, or to generate carrier excitation signals for resolvers. And for some industrial drives that need to include more I/O functions, the DACs could generate programmable analog output signals to signal or control other equipment nearby.

I/Os: sources, qualification, inversion, routing

The F28004x has programmable I/O multiplexing and negation, as well as the unique on-chip routing provided by the input, output and PWM crossbars.

Given the wealth of analog input possibilities available, there may be unused analog inputs on the F28004x in some dual-axis cases. For added flexibility, each analog input circuit can also serve as a general-purpose digital input.

When you consider the many I/O multiplexing options, digital peripherals whose pin assignments are selectable, it's easy to see how it's possible to optimize every pin of a given F28004x package. This feature is also a big reason why a dual-axis drive system is possible with a package that is limited to only 100-pins.

The F28004x can route some of the outputs back as inputs and do so on-chip – without using physical pins on the device. In addition, all of the digital inputs, including outputs routed back in, can qualify the input filtering for potential glitches. All inputs can likewise be negated on-chip, thus saving the potential need for external inverters when active-low signals need to be seen as active-high logic on-chip.

The input, output and PWM crossbars define the number and types of signals that can be routed to various control functions on the F28004x. These resources enable system features that otherwise would need to happen off-chip, or potentially enable functions that would not even be possible externally.

For example, you could take a PWM output channel (or perhaps more than one channel), and route them back as an input to the F28004x. The input could be qualified, negated and run to the PWM trip-zone block for digital comparison to a crossbar-available signal such as another PWM output signal, with Boolean logic. The result of that combination could then be the condition that trips the PWMs and protects the inverter. This kind of digital protection would otherwise need to happen with external circuits that would add dollars, not dimes, to the bill of materials.

Reducing or eliminating external storage devices

The F28004x has several additional features that can eliminate the need to add an external component for a unique board or system identification. For example, each device includes a C2000 unique identifier number in bank 0 of the one-time-programmable (OTP) flash. This unique ID contains a 256-bit value that comprises both randomly and sequentially coded parts. The first 192 bits are random, the next 32 bits are sequential and the last 32 bits are a checksum value. The unique ID can also act as a seed for code encryption on the device.

For a small amount of persistent OTP data, the F28004x includes two sectors of 2KB (4KB total) user-configurable OTP. This OTP memory includes a section that configures the part of the DCSM OTP.

As part of the security features of the F28004x, it's possible to restrict access to the contents of the OTP.

You can change the four available factory default boot-mode pins on the F28004x by programming a section of the user-configurable DCSM OTP locations. Possible boot selections are CAN, serial communications interface (SCI), SPI, I2C, on-chip flash, on-chip random access memory (RAM) or the 8-bit parallel I/O boot option.

ERAD for performance monitoring

An new C2000 capability is available with the F28004x. The integrated embedded real-time analysis and debugging (ERAD) module enhances debugging and system analysis capabilities with functions that otherwise might not be possible even with external components. The ERAD module consists of enhanced bus comparator units and benchmark system event counter units. The

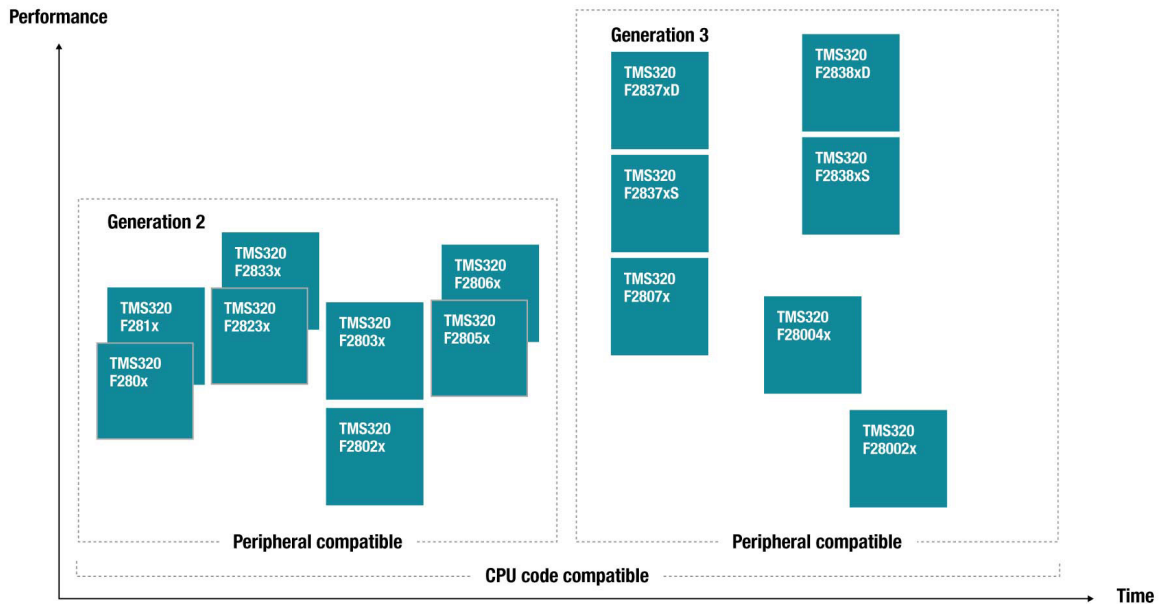

Figure 7. Product portfolio for real-time control.

enhanced bus comparator units generate hardware breakpoints, hardware watch points and other output events. The ERAD module is accessible both by the debugger and the application software, which significantly increases the debugging capabilities of many real-time systems, especially in situations where debuggers are not connected.

In addition to the debugging benefits, the ERAD unit can count CPU cycles between accesses to specified memory locations.

The benchmark system event counter units perform system analysis and profiling. In a drive or servo context, this capability could be particularly helpful in profiling the execution time of critical tasks such as an FOC current loop, or validating that the ADC is configured correctly and is achieving the expected conversion time.

Portfolio

To build upon the F28004x series TI has also introduced the F28002x series which includes a subset of the features described. Figure 7 shows a portfolio of options in regards to packages, memory sizes, and peripherals ideal for servo drive applications.

Conclusion

Given its system-level integration and performance, the F28004x and F28002x series offers a new value point for servo drive systems. But with the ability to support two servo motor inverters and feedback requirements simultaneously, the value of these C2000 controllers quickly doubles. Industrial servo and AC inverter drive developers who move quickly to adopt these new capabilities will lead the race to the next industrial motor drive market evolution.

The quickest way to begin exploring the capabilities of these devices is to order the C2000 MCU F280049C LaunchPad™ development kit from the TI store. To evaluate the performance of the DesignDRIVE FCL see the projects found in [C2000 Ware MotorControl SDK](#).

References

- Related documents:
 - [Designing the next generation of industrial drive and control systems](#)
 - [Flexible PWMs Enable Multi-Axis Drives, Multi-Level Inverters](#)
 - [Simple interfacing to analog and digital position sensors for industrial drive control systems](#)
 - [A faster current loop pays off in servo motor control](#)
 - [C2000 functional safety](#)
 - [F28004x product folder](#)
 - [F28002x product folder](#)
 - [F28002x brochure with F28004x comparison](#)
 - [Distributed Servo Drive Reference Design](#)

Important Notice: The products and services of Texas Instruments Incorporated and its subsidiaries described herein are sold subject to TI's standard terms and conditions of sale. Customers are advised to obtain the most current and complete information about TI products and services before placing orders. TI assumes no liability for applications assistance, customer's applications or product designs, software performance, or infringement of patents. The publication of information regarding any other company's products or services does not constitute TI's approval, warranty or endorsement thereof.

The platform bar is a trademark of Texas Instruments. All other trademarks are the property of their respective

owners. © 2020 Texas Instruments Incorporated



SWAY022A

IMPORTANT NOTICE AND DISCLAIMER

TI PROVIDES TECHNICAL AND RELIABILITY DATA (INCLUDING DATASHEETS), DESIGN RESOURCES (INCLUDING REFERENCE DESIGNS), APPLICATION OR OTHER DESIGN ADVICE, WEB TOOLS, SAFETY INFORMATION, AND OTHER RESOURCES "AS IS" AND WITH ALL FAULTS, AND DISCLAIMS ALL WARRANTIES, EXPRESS AND IMPLIED, INCLUDING WITHOUT LIMITATION ANY IMPLIED WARRANTIES OF MERCHANTABILITY, FITNESS FOR A PARTICULAR PURPOSE OR NON-INFRINGEMENT OF THIRD PARTY INTELLECTUAL PROPERTY RIGHTS.

These resources are intended for skilled developers designing with TI products. You are solely responsible for (1) selecting the appropriate TI products for your application, (2) designing, validating and testing your application, and (3) ensuring your application meets applicable standards, and any other safety, security, or other requirements. These resources are subject to change without notice. TI grants you permission to use these resources only for development of an application that uses the TI products described in the resource. Other reproduction and display of these resources is prohibited. No license is granted to any other TI intellectual property right or to any third party intellectual property right. TI disclaims responsibility for, and you will fully indemnify TI and its representatives against, any claims, damages, costs, losses, and liabilities arising out of your use of these resources.

TI's products are provided subject to TI's Terms of Sale (www.ti.com/legal/termsofsale.html) or other applicable terms available either on ti.com or provided in conjunction with such TI products. TI's provision of these resources does not expand or otherwise alter TI's applicable warranties or warranty disclaimers for TI products.

Mailing Address: Texas Instruments, Post Office Box 655303, Dallas, Texas 75265
Copyright © 2020, Texas Instruments Incorporated