

# **TPA3140D2 Design Considerations for EMC**

## **ABSTRACT**

The TPA3140D2 Class D audio power amplifier is the latest TI analog input amplifier that uses advanced PWM switching techniques for reducing electromagnetic interference (EMI) without degrading audio performance. This application note describes the system design and printed circuit board (PCB) guidelines used to maximize the technology employed in the TPA3140D2 device. These techniques include the EMI suppression without the need for expensive inductor filters and the reduction of external component count.

## **Contents**

1	General Overview.....	2
2	Advanced Emission Suppression .....	2
	2.1 Spread Spectrum Modulation .....	2
	2.2 Dephase and Edge Rate Control .....	4
3	Printed Circuit Board Design for EMC .....	4
	3.1 Printed Circuit Board Layout .....	4
	3.2 Ferrite Bead Filter.....	5
	3.3 Power Supply and Speaker Wires.....	5
4	TPA3140D2 EVM EMI Results.....	5
	4.1 EN55013 Radiated Emission Results .....	5
	4.2 EN55022 Conducted Emission Results.....	6
	4.3 Conclusions.....	7

## **List of Figures**

1	Class D Audio Amplifier .....	2
2	Fixed-Frequency Mode Modulation .....	3
3	Spread Spectrum Mode Modulation.....	3
4	Comparison of FFM and SSM Modulation .....	4
5	Radiated Emission – Horizontal Pre-Scan .....	5
6	Radiated Emission – Vertical Pre-Scan.....	6
7	Conducted Emission – Line Pre-Scan .....	6
8	Conducted Emission – Neutral Pre-Scan.....	7

## **List of Tables**

1	Radiated Emission Margins – Horizontal .....	5
2	Radiated Emission Margins – Vertical .....	6
3	Conducted Emission Margins – Line .....	7
4	Conducted Emission Margins – Neutral .....	7

## 1 General Overview

The emphasis on green technologies and sleek looking electronics (such as the flat panel TV) has lead manufacturers to produce space-efficient and attractive products without sacrificing performance. The TPA3140D2 mono/stereo Class D audio power amplifier provides Class AB audio performance using only the PC board as heat sink due to its high efficiency. In addition, the TPA3140D2 device has advanced PWM modulation and switching schemes that help reduce EMI while eliminating the need for the traditional Class D output filter. PWM filtering requires only smaller and less expensive RF filter components. No external heat sink and less RF filtering result directly in PC board size reduction.

Discussions in the following sections explain the PC board layout practice and external components selection in order to achieve optimal audio performance and pass electromagnetic compatibility (EMC) specification EN55022.

- [Section 2](#) describes the advanced emission suppression techniques used to combat EMI.
- [Section 3](#) discusses the PC board design guidelines for audio quality and EMC.
- [Section 4](#) shows the EMC results for TPA3140D2 EVM.

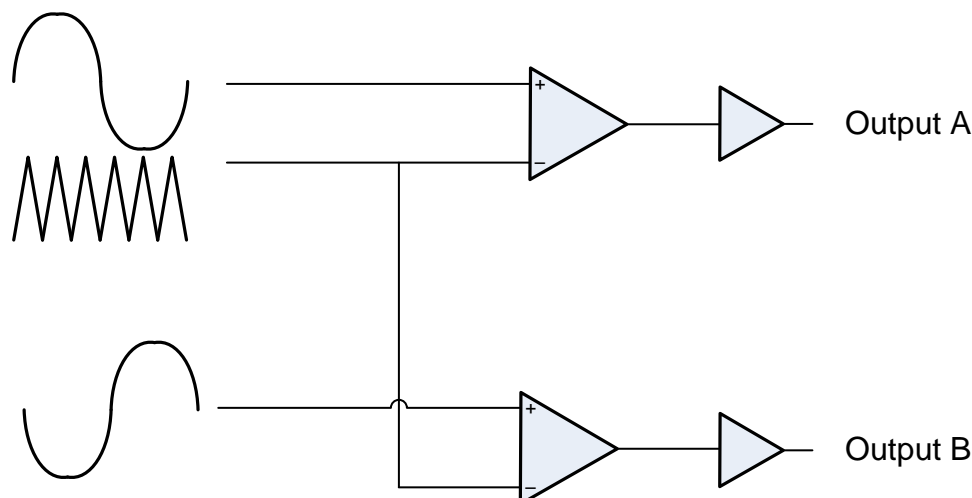
## 2 Advanced Emission Suppression

### 2.1 Spread Spectrum Modulation

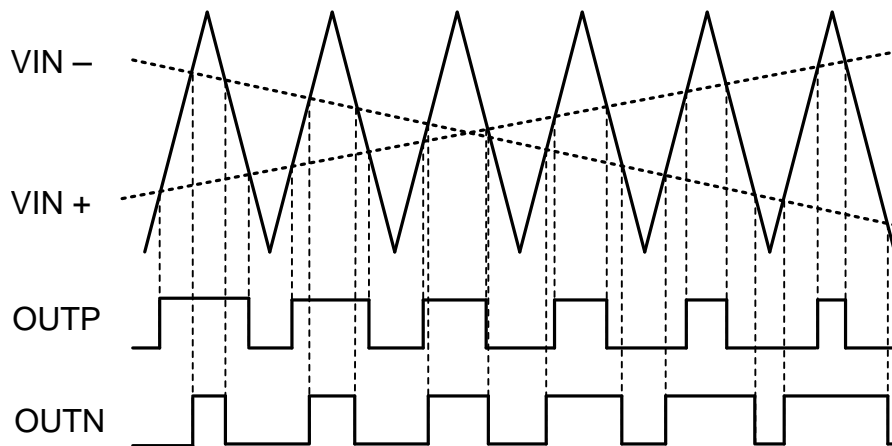
EMI is electromagnetic radiation emitted by electrical systems with fast changing signals that are common to the outputs of a class D audio power amplifier. EMI encompasses two aspects: emission and susceptibility. Emission refers to the generation of unwanted electromagnetic energy by the equipment. Susceptibility, by contrast, refers to the degree in which the equipment is affected by the electromagnetic disturbances. EMC is achieved by addressing both emission and susceptibility issues. The TPA3140D2 device has advanced emission suppression technology which enables the device to run without an LC filter with speaker wires up to one meter long and still meet the EMI regulatory standards such as EN55022, CISPR 22, or FCC Part 15 Class B.

The TPA3140D2 device features an advanced spread spectrum modulation mode with low EMI emission to lower the overall system cost. This reduced system cost is achieved by replacing large expensive LC output filters with small, low-cost ferrite beads filters. The spread spectrum modulation scheme exhibits less EMI by flattening the wideband spectral components from the speaker cables and still retains the high-efficiency feature of a traditional class D amplifier such as the TPA3110D2 device.

[Figure 1](#) shows the topology of a conventional (nonspread-spectrum) BD modulation class D amplifier. The BD switching technique uses an internally generated triangular waveform with a fixed frequency and a complementary signal pair at the input stage. The output PWM changes the duty cycle to generate a moving average of the signal that correspond to the input analog signal. The advantages of PWM switching topology is high efficiency, which provides low power consumption and small thermal design.

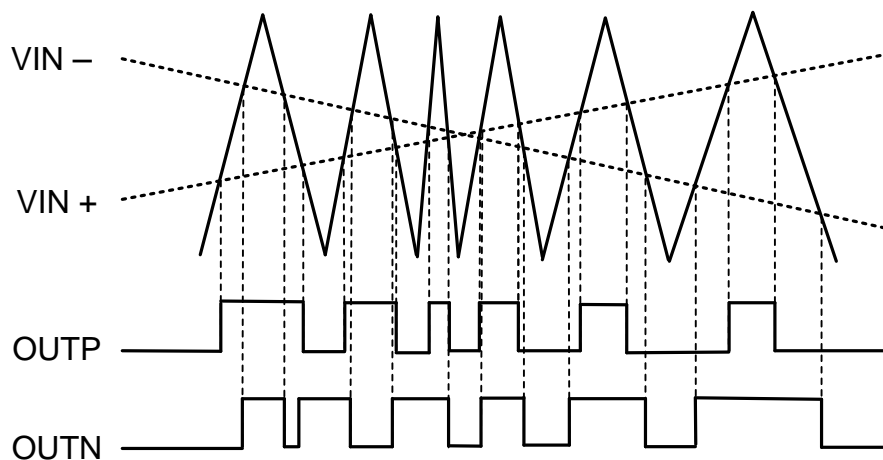


**Figure 1. Class D Audio Amplifier**



**Figure 2. Fixed-Frequency Mode Modulation**

The TPA3140D2 device features two modulation modes: fixed-frequency modulation mode (FFM) and spread spectrum modulation (SSM) mode. In the conventional FFM mode (Figure 1) the frequency of the triangular waveform is fixed as shown in Figure 2. In SSM mode, the frequency of the triangular waveform frequency varies by  $\pm 10\%$  cycle-to-cycle with a center frequency at about 310 kHz. SSM mode improves EMI emissions radiated by the speaker wires by spreading the energy over a larger bandwidth and reducing the wideband spectral content. On the other hand, FFM produces larger amounts of spectral energy at multiples of the PWM switching frequency. The cycle-to-cycle variation of the switching frequency does not affect the efficiency of the audio amplifier. Figure 3 shows the effects of the frequency variation on the triangular waveform.



**Figure 3. Spread Spectrum Mode Modulation**

Compared to traditional FFM class D amplifier, the spread spectrum scheme has reduced the peak energy of the switching frequency and lessens harmonics. shows a comparison of FFM and SSM modulation.

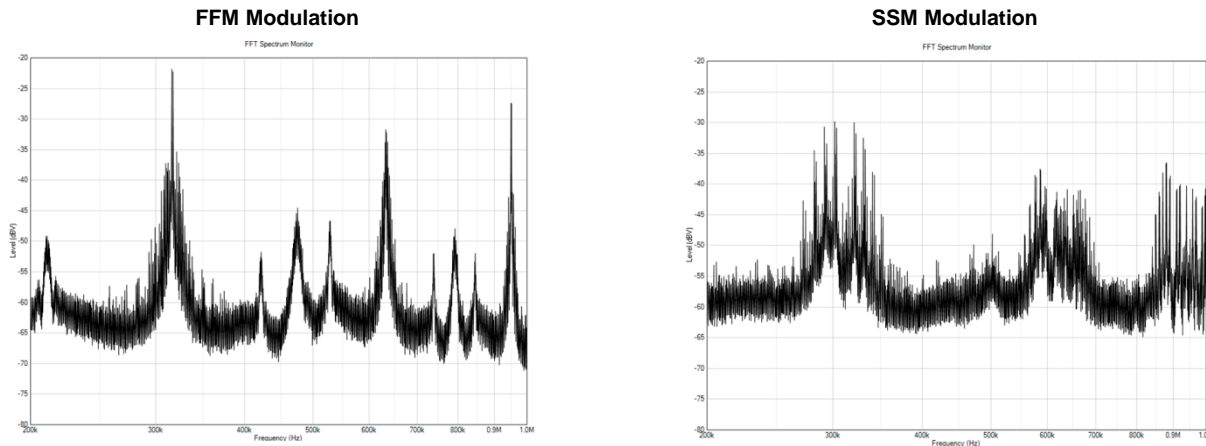


Figure 4. Comparison of FFM and SSM Modulation

## 2.2 Dephase and Edge Rate Control

In addition to the spread spectrum technology, the TPA3140D2 device employs edge rate control and dephase circuits to further reduce electromagnetic emission without degrading audio performance.

The edge rate control circuit reduces emission by controlling the PWM output FET switching transitions near the rails with as little impact to the efficiency as possible. In this mode, the edge rate is optimized and fixed.

The dephase circuit improves EMI and noise performance by interleaving the switching timing between the two audio channels. This improved EMI and noise performance reduces conducted emission on the PVCC line because the output ripple current of the two audio channels will be out of phase, and the ripple peak current from the PVCC line will thus be reduced to half value.

## 3 Printed Circuit Board Design for EMC

### 3.1 Printed Circuit Board Layout

It is necessary to follow recommended PC board guidelines for EMC success. Proper PC board floor planning, component selection, component placement, and routing are all essential to counter EMI. Emissions are exacerbated by improper layout, components, and output trace length causing antenna effect. Practical PC board design guidelines for achieving EMC include:

- Place the high-frequency decoupling capacitors as close to the power pin and ground pin of the device as possible to reduce the parasitic inductance of the trace. To ensure low AC impedance over a wide frequency range for noise reduction, use good quality, low-ESR, 1-nF ceramic capacitors. For mid-frequency noise due to PWM transients, use another good quality 0.1  $\mu$ F ceramic capacitor placed as close as possible to the PV<sub>CC</sub> leads.
- Use a continuous ground plane and avoid voltage offset on the ground planes whenever possible.
- Low impedance routing back to source (return signal).
- Power planes should be away from the edges of the PC board.
- Proper filtering of the PC board connectors.
- Place EMC snubbers and ferrite bead filters as close as possible to the IC. Minimize unfiltered loops and trace length as well as stray inductance.
- Keep amplifier output traces to the speaker as short as possible. PC board traces and the speaker wire are the largest sources of emission.

### 3.2 Ferrite Bead Filter

Low-cost ferrite bead filters are used to suppress EMI. They are placed close to the amplifier output to minimize loop antennas. At low frequencies, ferrite beads act as 0 Ω resistors with no DC drop. However, the impedance of ferrite bead increases significantly at frequencies above 1 MHz to suppress radiation. Ferrite beads also play a significant role on the THD+N of the system. Examples of ferrite beads which have been tested and worked well with the TPA3140D2 device include the NFZ2MSM series from Murata. If other ferrite beads are used, the EMC testing must be repeated to ensure compliance.

### 3.3 Power Supply and Speaker Wires

When performing the conducted emission test, it is essential to keep the AC power cable away from the speaker cables. This prevents stray signals from coupling to power source and other potential unintended radiators or conductors.

## 4 TPA3140D2 EVM EMI Results

The following sections show the EMI test results from a certified third-party vendor (National Technical Systems) in Plano, TX. The passing margins are greater than 10 dBuV in most cases.

The radiated EMI plots below are taken with standard EVM configuration and BOM components.

The conducted EMI plots are taken using the same EVM configuration but with a TV power supply. The TV is currently available on US consumer market (2015).

### 4.1 EN55013 Radiated Emission Results

TPA3140D2 EVM, PVCC = 12 V, 8-Ω load, up to 1-meter speaker cable, Spread Spectrum enabled, Po = 1.25 W

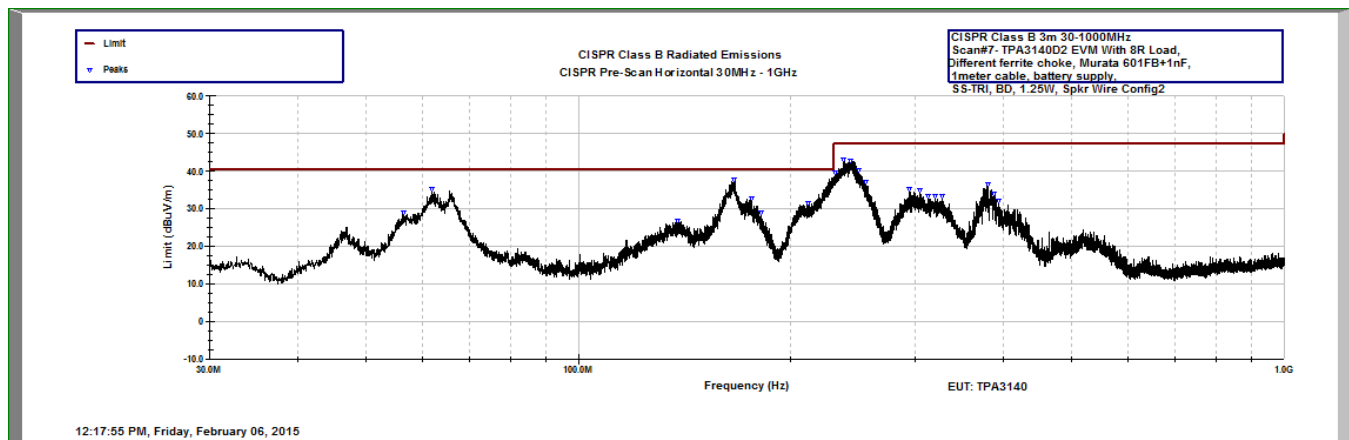


Figure 5. Radiated Emission – Horizontal Pre-Scan

Table 1. Radiated Emission Margins – Horizontal

Frequency MHz	Limit dBuV/m	Peaks dBuV/m	Q-Peak dBuV/m	Margin dB	Turn Table Degrees	Tower cm
166.246	40.457	21.781	21.975	-18.482	44.9	100
237.372	47.457	29.330	29.186	-18.271	326.9	100

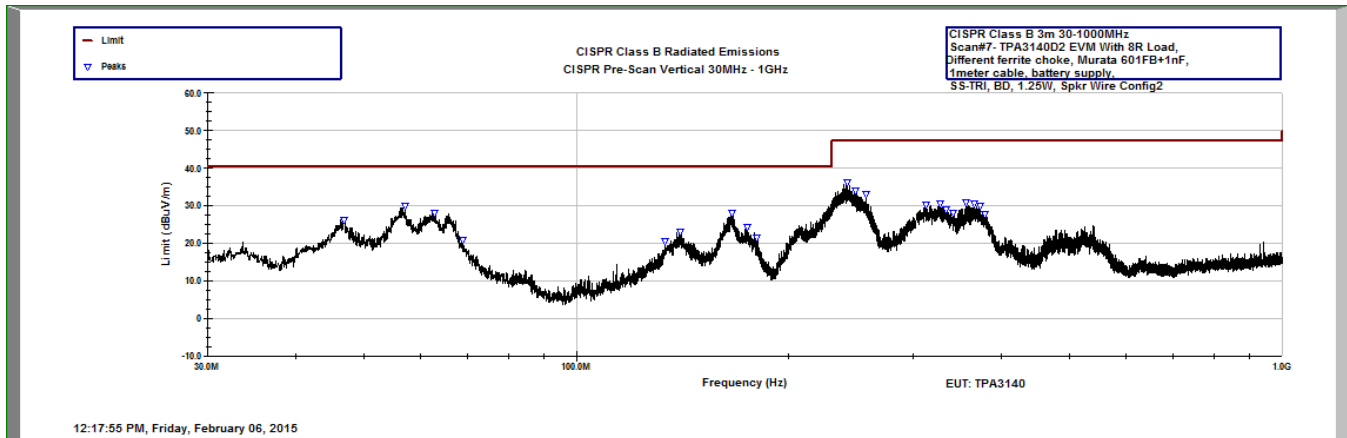


Figure 6. Radiated Emission – Vertical Pre-Scan

Table 2. Radiated Emission Margins – Vertical

Frequency MHz	Limit dBuV/m	Peaks dBuV/m	Q-Peak dBuV/m	Margin dB	Turn Table Degrees	Tower cm
56.841	40.457	26.213	27.058	-13.399	54	100
241.9	47.457	19.429	20.430	-27.027	-0.1	100

#### 4.2 EN5022 Conducted Emission Results

TV (40-inch) from the major TV manufacturer, TPA3140D2 EVM, PVCC = 12 V, 8-Ω speakers, Spread Spectrum enabled,  $P_o = 1.25$  W

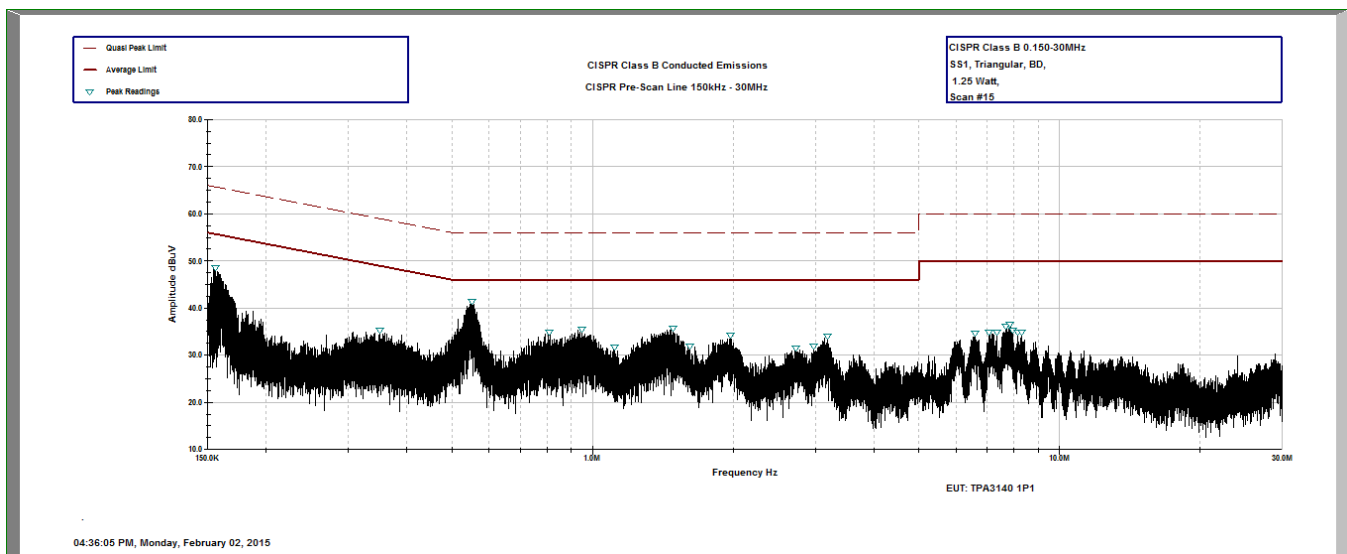
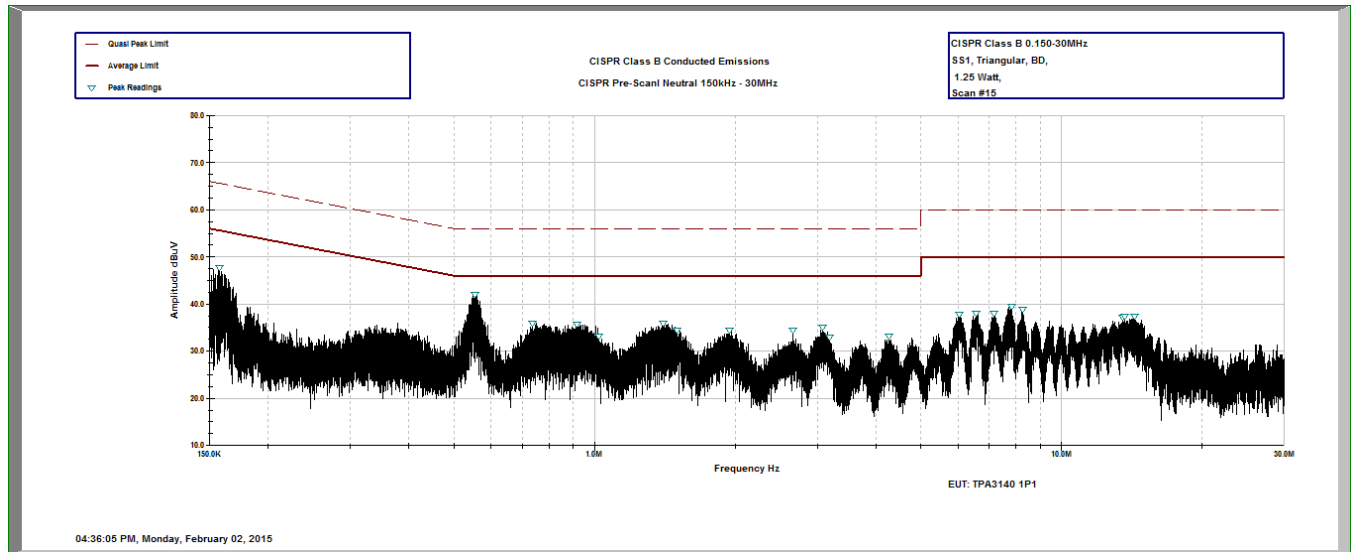


Figure 7. Conducted Emission – Line Pre-Scan

**Table 3. Conducted Emission Margins – Line**

Frequency MHz	QP Limit dBuV	AVE Limit dBuV	AVE Readings dBuV	AVE Margin dB	QP Readings dBuV	QP Margin dB
0.156	65.83	55.83	33.774	-22.056	45.956	-19.873
0.552	56	46	28.872	-17.128	39.164	-16.836
0.806	56	46	21.341	-24.659	29.585	-26.415
0.95	56	46	22.678	-23.322	31.471	-24.529
1.485	56	46	22.622	-23.378	31.082	-24.918
1.976	56	46	20.952	-25.048	29.849	-26.151



**Figure 8. Conducted Emission – Neutral Pre-Scan**

**Table 4. Conducted Emission Margins – Neutral**

Frequency MHz	QP Limit dBuV	AVE Limit dBuV	AVE Readings dBuV	AVE Margin dB	QP Readings dBuV	QP Margin dB
0.158	65.785	55.785	34.022	-21.763	45.398	-20.387
0.554	56	46	29.574	-16.426	40.485	-15.515
0.735	56	46	22.652	-23.348	32.52	-23.48
0.918	56	46	22.699	-23.301	31.849	-24.151
1.402	56	46	23.264	-22.736	32.173	-23.827
7.806	60	50	28.006	-21.994	35.214	-24.786

### 4.3 Conclusions

The TPA3140D2 device has the proven advanced RF emission suppression technology that helps to design an EMI-compliant audio system without compromising cost and performance. The EVM User's Guide ([SLOU405](#)) provides the details of the schematic and BOM. By adhering to the guidelines discussed in this report, EMI requirements are met and costly PC board rework is avoided.

For further questions and discussions on this topic, go to the TI E2E Forums (<http://e2e.ti.com/>).

## IMPORTANT NOTICE

Texas Instruments Incorporated and its subsidiaries (TI) reserve the right to make corrections, enhancements, improvements and other changes to its semiconductor products and services per JESD46, latest issue, and to discontinue any product or service per JESD48, latest issue. Buyers should obtain the latest relevant information before placing orders and should verify that such information is current and complete. All semiconductor products (also referred to herein as "components") are sold subject to TI's terms and conditions of sale supplied at the time of order acknowledgment.

TI warrants performance of its components to the specifications applicable at the time of sale, in accordance with the warranty in TI's terms and conditions of sale of semiconductor products. Testing and other quality control techniques are used to the extent TI deems necessary to support this warranty. Except where mandated by applicable law, testing of all parameters of each component is not necessarily performed.

TI assumes no liability for applications assistance or the design of Buyers' products. Buyers are responsible for their products and applications using TI components. To minimize the risks associated with Buyers' products and applications, Buyers should provide adequate design and operating safeguards.

TI does not warrant or represent that any license, either express or implied, is granted under any patent right, copyright, mask work right, or other intellectual property right relating to any combination, machine, or process in which TI components or services are used. Information published by TI regarding third-party products or services does not constitute a license to use such products or services or a warranty or endorsement thereof. Use of such information may require a license from a third party under the patents or other intellectual property of the third party, or a license from TI under the patents or other intellectual property of TI.

Reproduction of significant portions of TI information in TI data books or data sheets is permissible only if reproduction is without alteration and is accompanied by all associated warranties, conditions, limitations, and notices. TI is not responsible or liable for such altered documentation. Information of third parties may be subject to additional restrictions.

Resale of TI components or services with statements different from or beyond the parameters stated by TI for that component or service voids all express and any implied warranties for the associated TI component or service and is an unfair and deceptive business practice. TI is not responsible or liable for any such statements.

Buyer acknowledges and agrees that it is solely responsible for compliance with all legal, regulatory and safety-related requirements concerning its products, and any use of TI components in its applications, notwithstanding any applications-related information or support that may be provided by TI. Buyer represents and agrees that it has all the necessary expertise to create and implement safeguards which anticipate dangerous consequences of failures, monitor failures and their consequences, lessen the likelihood of failures that might cause harm and take appropriate remedial actions. Buyer will fully indemnify TI and its representatives against any damages arising out of the use of any TI components in safety-critical applications.

In some cases, TI components may be promoted specifically to facilitate safety-related applications. With such components, TI's goal is to help enable customers to design and create their own end-product solutions that meet applicable functional safety standards and requirements. Nonetheless, such components are subject to these terms.

No TI components are authorized for use in FDA Class III (or similar life-critical medical equipment) unless authorized officers of the parties have executed a special agreement specifically governing such use.

Only those TI components which TI has specifically designated as military grade or "enhanced plastic" are designed and intended for use in military/aerospace applications or environments. Buyer acknowledges and agrees that any military or aerospace use of TI components which have **not** been so designated is solely at the Buyer's risk, and that Buyer is solely responsible for compliance with all legal and regulatory requirements in connection with such use.

TI has specifically designated certain components as meeting ISO/TS16949 requirements, mainly for automotive use. In any case of use of non-designated products, TI will not be responsible for any failure to meet ISO/TS16949.

### Products

Audio	<a href="http://www.ti.com/audio">www.ti.com/audio</a>
Amplifiers	<a href="http://amplifier.ti.com">amplifier.ti.com</a>
Data Converters	<a href="http://dataconverter.ti.com">dataconverter.ti.com</a>
DLP® Products	<a href="http://www.dlp.com">www.dlp.com</a>
DSP	<a href="http://dsp.ti.com">dsp.ti.com</a>
Clocks and Timers	<a href="http://www.ti.com/clocks">www.ti.com/clocks</a>
Interface	<a href="http://interface.ti.com">interface.ti.com</a>
Logic	<a href="http://logic.ti.com">logic.ti.com</a>
Power Mgmt	<a href="http://power.ti.com">power.ti.com</a>
Microcontrollers	<a href="http://microcontroller.ti.com">microcontroller.ti.com</a>
RFID	<a href="http://www.ti-rfid.com">www.ti-rfid.com</a>
OMAP Applications Processors	<a href="http://www.ti.com/omap">www.ti.com/omap</a>
Wireless Connectivity	<a href="http://www.ti.com/wirelessconnectivity">www.ti.com/wirelessconnectivity</a>

### Applications

Automotive and Transportation	<a href="http://www.ti.com/automotive">www.ti.com/automotive</a>
Communications and Telecom	<a href="http://www.ti.com/communications">www.ti.com/communications</a>
Computers and Peripherals	<a href="http://www.ti.com/computers">www.ti.com/computers</a>
Consumer Electronics	<a href="http://www.ti.com/consumer-apps">www.ti.com/consumer-apps</a>
Energy and Lighting	<a href="http://www.ti.com/energy">www.ti.com/energy</a>
Industrial	<a href="http://www.ti.com/industrial">www.ti.com/industrial</a>
Medical	<a href="http://www.ti.com/medical">www.ti.com/medical</a>
Security	<a href="http://www.ti.com/security">www.ti.com/security</a>
Space, Avionics and Defense	<a href="http://www.ti.com/space-avionics-defense">www.ti.com/space-avionics-defense</a>
Video and Imaging	<a href="http://www.ti.com/video">www.ti.com/video</a>

### TI E2E Community

[e2e.ti.com](http://e2e.ti.com)