

TPA324x and TPA325x Post-Filter Feedback

Dan Kisling, Matthew Beardsworth

ABSTRACT

The TPA324x and TPA325x (TPA3244, TPA3245, TPA3250, TPA3251, TPA3255) Class-D audio amplifier families deliver high audio performance with less than 0.01% total harmonic distortion and noise (THD+N) to clipping. The high level of audio performance makes this device an ideal candidate for high resolution and high fidelity audio applications, which previously could only be achieved by Class-AB amplifiers. The TPA324x and TPA325x devices are analog input, closed loop (internal feedback network) Class-D audio amplifiers that can be further enhanced by adding an additional post-filter feedback (PFFB) or PFFB loop. This application report shows one optional implementation of PFFB for the TPA3244, TPA3245, TPA3250, TPA3251, and TPA3255 amplifiers.

PFFB offers many benefits including lower output noise, improved THD+N performance, improved IMD performance, lower output impedance, frequency response less affected by load impedance, and suppression of nonlinearities of the LC filter.

Contents

1	PFFB Implementation	2
2	Closed Loop Gain.....	4
3	LC Filter Distortion	5
4	Performance Results	6
5	Output Noise	6
6	SNR and DNR.....	6
7	THD+N vs Power	7
8	THD+N vs Frequency	9
9	SMPTE IMD.....	11
10	CCIF IMD.....	12
11	Stability Analysis	13
12	Stability Testing.....	14
13	Overshoot for Square Wave Input	14
14	Calculating Phase Margin	15
15	TPA3245 PFFB Stability.....	16
16	Frequency Reponse at Full Scale.....	18
Appendix A	TPA3244.....	19
Appendix B	TPA3245.....	25
Appendix C	TPA3250.....	31
Appendix D	TPA3251.....	37
Appendix E	TPA3255.....	43

Trademarks

All trademarks are the property of their respective owners.

1 PFFB Implementation

Post filter feedback is implemented by adding a secondary feedback loop external to the amplifier. This feedback loop takes a fraction of the output voltage signal of the amplifier after the external LC filter and sends an error signal back to the input of the amplifier. See [Figure 1](#).

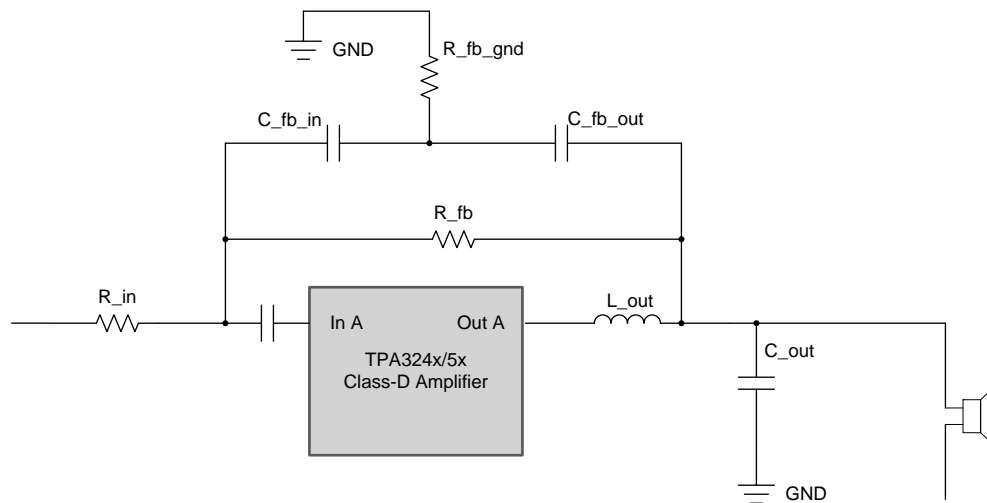

Copyright © 2017, Texas Instruments Incorporated

Figure 1. Post-Filter Feedback Loop

The following components are required for PFFB implementation:

- R_fb – Feedback resistor
- C_fb_in – Capacitor on input side of the feedback network
- C_fb_out – Capacitor on output side of the feedback network
- R_fb_gnd – Resistor between C_fb_in and C_fb_out to GND in the feedback network
- R_in – Input summing junction resistor
- C_z – Zobel network capacitor
- R_z – Zobel network resistor
- C_op – Op-Amp feedback capacitor
- R_op-fb – Op-Amp feedback resistor

Figure 2 shows the passive PFFB implementation used throughout the document for TPA3244, TPA3245, TPA3250, TPA3251, and TPA3255 amplifiers.

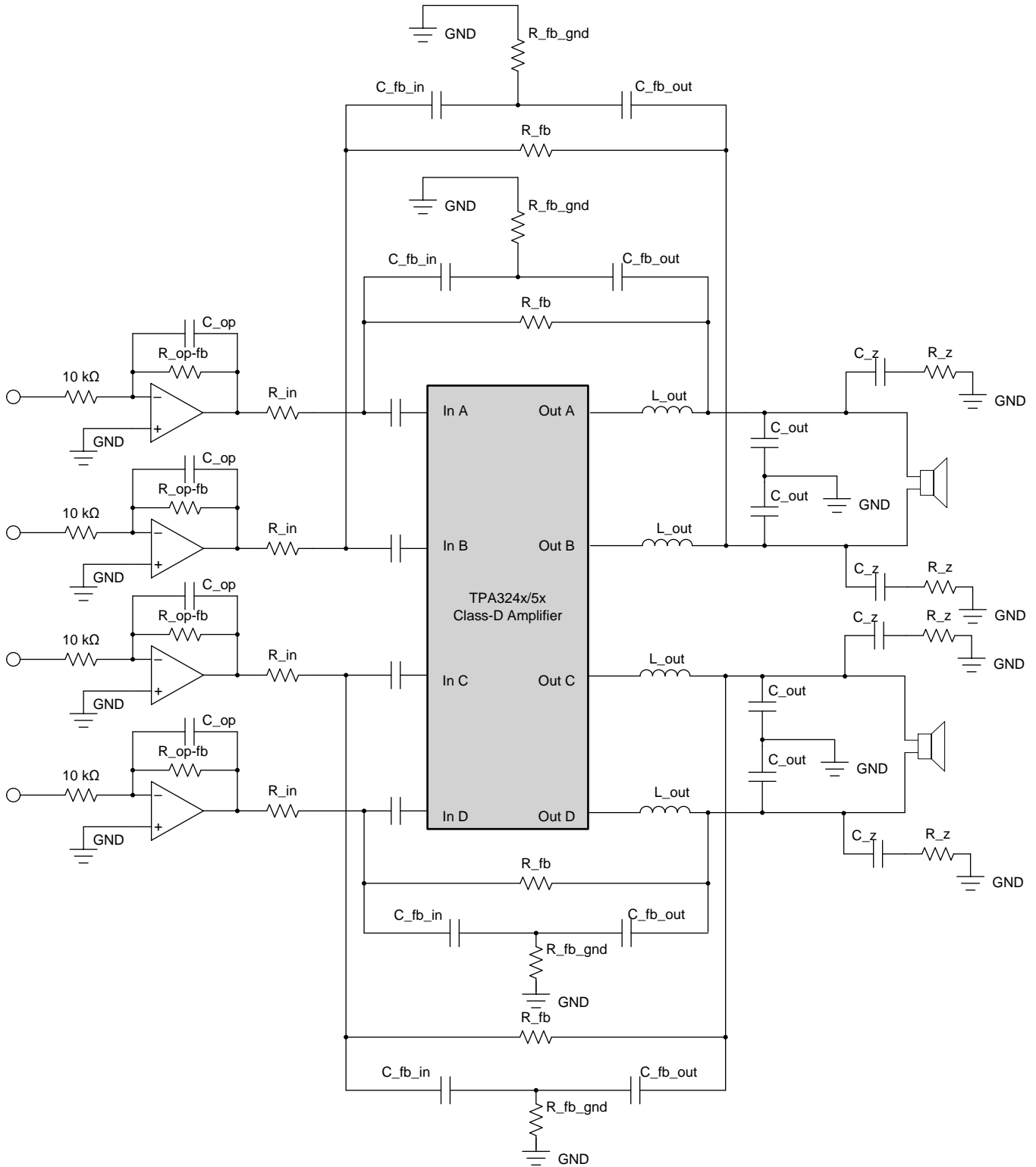

Copyright © 2017, Texas Instruments Incorporated

Figure 2. Passive PFFB Implementation

Table 1 lists the component values that have improved audio performance and sufficient stability.

Table 1. Recommended PFFB Component Values

PFFB Designator	EVM Schematic Location and Designator	TPA3244 (PVDD = 30 V, Fpwm = 450 kHz)	TPA3245 (PVDD = 30 V, Fpwm = 600 kHz)	TPA3250 (PVDD = 36 V, Fpwm = 450 kHz)	TPA3251 (PVDD = 36 V, Fpwm = 600 kHz)	TPA3255 (PVDD = 51 V, Fpwm = 450 kHz)
L_out	L2, L3, L4, L5	10 μ H	10 μ H	10 μ H	7 μ H	10 μ H
C_out	C24, C35, C43, C59	1 μ F	1 μ F	1 μ F	680 nF	1 μ F
R_fb	R47, R49, R50, R51	18 k Ω	18 k Ω	18 k Ω	18 k Ω	33 k Ω
C_fb_in	N/A	220 pF	220 pF	220 pF	220 pF	220 pF
C_fb_out	N/A	220 pF	1 nF	220 pF	1 nF	220 pF
R_fb_gnd	N/A	2 k Ω	2 k Ω	2 k Ω	2 k Ω	10 k Ω
R_in	R4, R12, R44, R46	2.7 k Ω	2.7 k Ω	2.7 k Ω	2.7 k Ω	2.7 k Ω
C_z	C77, C78, C79, C80	220 nF	220 nF	220 nF	220 nF	220 nF
R_z	R54, R55, R56, R57	1 Ω	1 Ω	1 Ω	1 Ω	1 Ω
C_op	C18, C23, C57, C65	330 pF	330 pF	330 pF	330 pF	330 pF
R_op_fb	R8, R41, R21, R25	10 k Ω	10 k Ω	10 k Ω	10 k Ω	10 k Ω

- R_fb and R_in controls the amount of negative feedback used in this system.
- C_fb_in, C_fb_out, and R_fb_gnd make a feedback network that helps with open load response and overall network stability.
- C_z and R_z create the Zobel Network and are required for network stability.

The Zobel network helps attenuate the high-frequency ringing by damping the amplitude response of the output of the LC filter and lowering the quality factor (Q). This is especially required for open-load stability where the Q of the LC filter is extremely large due to the lack of dampening from the load impedance. Reducing the Q of the output filter also increases stability, by relaxing the phase shift associated with a high Q system.

It is best to keep the feedback components close to the device so the feedback signals are not subject to significant distortion or noise.

2 Closed Loop Gain

With the components for PFFB selected and the gain on the amplifier known, the new closed loop gain can be estimated. Equation 1 shows the closed-loop gain.

$$A_f = \frac{A_0}{(1 + A_0\beta)} \quad (1)$$

Use Equation 2 to calculate the feedback factor.

$$\beta = \frac{R_{in}}{R_{in} + R_{fb}} \quad (2)$$

Using Equation 1 and Equation 2, the PFFB gain and the negative feedback gain can be calculated. Equation 3 shows an example for the TPA3251.

$$A_o = 20 \text{ dB} = 10 \quad \beta = \frac{2.7 \text{ k}}{(2.7 \text{ k} + 18 \text{ k})} = 0.13$$

$$A_f = \frac{10}{(1 + (10 \times 0.13))} = 4.35 = 12.8 \text{ dB}$$

where

- The closed loop gain has been reduced to 12.8 dB due to PFFB
 - 7.2 dB of PFFB has been applied to the amplifier
- (3)

Approximately 6 to 7 dB of PFFB has been applied to each amplifier. Table 2 lists the results.

Table 2. PFFB Parameters

Feedback Parameters	TPA3244 (PVDD = 30 V, Fpwm = 450 kHz)	TPA3245 (PVDD = 30 V, Fpwm = 600 kHz)	TPA3250 (PVDD = 36 V, Fpwm = 450 kHz)	TPA3251 (PVDD = 36 V, Fpwm = 600 kHz)	TPA3255 (PVDD = 51 V, Fpwm = 450 kHz)
Gain (dB)	18	18	20	20	21.5
Feedback factor	0.130	0.130	0.130	0.130	0.076
PFFB gain A_f (dB)	11.82	11.82	12.75	12.75	15.93
Negative feedback	6.18	6.18	7.25	7.25	5.57

3 LC Filter Distortion

The LC filter extracts a continuous analog audio signal from the PWM output for the Class-D to suppress radiating EMI and ripple current in the load connected. However, since the TPA324x and TPA325x families offer such a high level of performance, the inductor used in the LC filter is the primary contributor to distortion. By feeding back the output after the inductor in PFFB, inductor and capacitor distortion can be reduced significantly. For systems where lower distortion is not a requirement, PFFB can allow for the use of a smaller and less expensive inductor or capacitor and correct for some added distortion. Since smaller inductors are usually less linear and cause higher distortion, the distortion improvement offered by PFFB can allow very good system performance even with an inductor of this type. The same can be stated for smaller and cheaper capacitors.

Figure 3 shows the performance difference between two different 10-μH inductors on the TPA3245. With PFFB, not only does the overall performance of the amplifier improve, but the performance gap between the two inductors has been reduced.

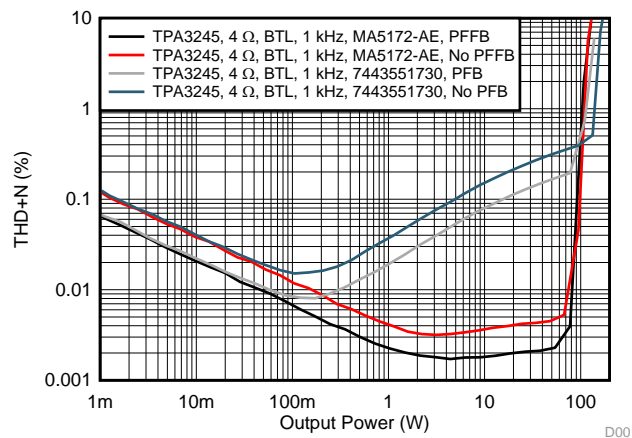

Figure 3. THD+N vs Power Inductor Comparison

4 Performance Results

PFFB is implemented on the TPA3245, TPA3251, TPA3255, TPA3244, and TPA3250 EVM. The performance of the EVM is measured, and then the performance of the EVM with PFFB is implemented for the same conditions. The following measurements were completed for all devices. For select audio performance results, only the TPA3245 performance results are shown to make the document easier to read. The rest of the amplifier results can be found in the appendix.

5 Output Noise

Output noise is almost cut in half for systems with PFFB implemented. The lower the noise floor, the better users will be able to hear the small details in the audio. [Table 3](#) lists the A-weighted noise.

Table 3. Noise – A Weighted

EVM Configuration	TPA3244 (PVDD = 30 V, Fpwm = 450 kHz)	TPA3245 (PVDD = 30 V, Fpwm = 600 kHz)	TPA3250 (PVDD = 36 V, Fpwm = 450 kHz)	TPA3251 (PVDD = 36 V, Fpwm = 600 kHz)	TPA3255 (PVDD = 51 V, Fpwm = 450 kHz)
Standard configuration	54.5 μ V	54.4 μ V	62.7 μ V	61.4 μ V	81.5 μ V
PFFB	29.5 μ V	28.7 μ V	30.5 μ V	28.3 μ V	46.2 μ V

6 SNR and DNR

Signal to Noise Ratio (SNR) and Dynamic Range Ratio (DNR) are both very critical numbers to evaluate the audio performance of an amplifier. In a single number, they summarize how the low output noise compares to the how loud the amplifier can be. The lower the number, the better the system sounds. The difference between SNR and DNR is that for SNR, the input signal is grounded. For DNR, the input signal is very small (–60 dB of the input signal required achieving the power level corresponding to 1% THD+N). Both are important to look at because some circuits may be activated in an IC at very small signals that may not be activated when the outputs are grounded.

[Table 4](#) lists the A-weighted SNR.

Table 4. SNR – A Weighted

EVM Configuration	TPA3244 (PVDD = 30 V, Fpwm = 450 kHz)	TPA3245 (PVDD = 30 V, Fpwm = 600 kHz)	TPA3250 (PVDD = 36 V, Fpwm = 450 kHz)	TPA3251 (PVDD = 36 V, Fpwm = 600 kHz)	TPA3255 (PVDD = 51 V, Fpwm = 450 kHz)
Standard configuration	–111.4 dB	–111.5 dB	–111.3 dB	–111.8 dB	–111.9 dB
PFFB	–116.8 dB	–116.8 dB	–117.4 dB	–117.8 dB	–116.5 dB

[Table 5](#) lists the A-weighted DNR.

Table 5. DNR – A Weighted

EVM Configuration	TPA3244 (PVDD = 30 V, Fpwm = 450 kHz)	TPA3245 (PVDD = 30 V, Fpwm = 600 kHz)	TPA3250 (PVDD = 36 V, Fpwm = 450 kHz)	TPA3251 (PVDD = 36 V, Fpwm = 600 kHz)	TPA3255 (PVDD = 51 V, Fpwm = 450 kHz)
Standard configuration	–111.2 dB	–111.5 dB	–111.1 dB	–111.6 dB	–111.9 dB
PFFB	–117.1 dB	–116.9 dB	–117.5 dB	–117.6 dB	–116.5 dB

7 THD+N vs Power

THD+N vs Power curves can tell you the power performance of the device at a single frequency. You can use this curve to get power numbers for the device, such as the power at 1% THD+N and 10% THD+N. Additionally, this curve is useful to see how the amplifier performs at lower powers that are critical for how the amplifier sounds at typical room volumes such as 1 W to 10 W. As seen in Figure 4, PFFB in this system slightly limits the high power performance of the device because the input op amps start to saturate at voltages high enough to drive the amplifier to high power. The lower power performance which is very critical to how an amplifier actually sounds to a human ear is improved by roughly 5 dB with this PFFB configuration. As an example, the TPA3245 is used below with a 4 Ω Load in BTL with a PVDD = 30 V.

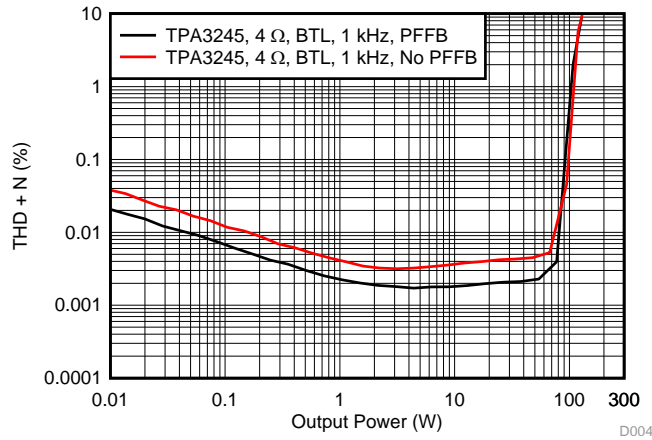

Figure 4. THD+N vs Power at 1 kHz

Table 6. TPA3245: 1-kHz Input

Output Power (W)	THD+N (dB)		
	Standard EVM	PFFB	Difference
0.01	-68.383	-73.669	-5.28
0.1	-78.305	-83.263	-4.958
1	-87.610	-92.844	-5.234
10	-88.768	-94.845	-6.076

1 kHz is the standard signal for THD+N curves but other frequencies are common and useful. A 100-Hz value gives insight in how the lower frequency performance is and can be useful for woofer or subwoofer design.

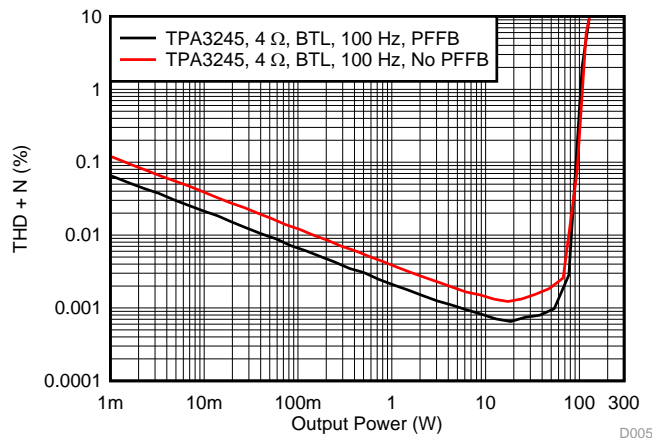
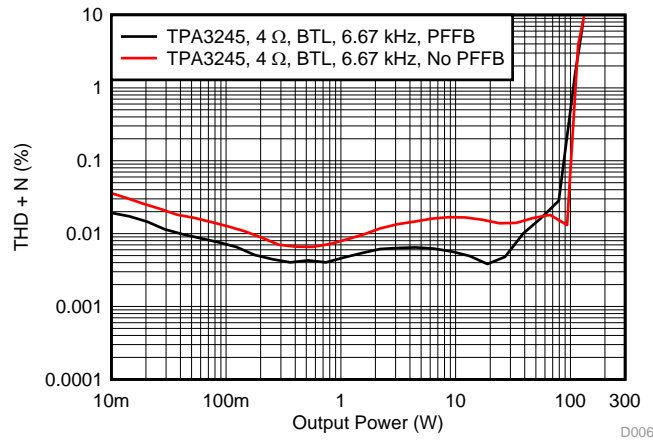

Figure 5. THD+N vs Power at 100 Hz

Table 7. TPA3245: 100-Hz Input

Output Power (W)	THD+N (dB)		
	Standard EVM	PFFB	Difference
0.01	-68.211	-73.418	-5.208
0.1	-78.243	-83.479	-5.236
1	-88.141	-93.446	-5.304
10	-96.802	-102.021	-5.219

6.67 kHz is also useful to see because this is typically a challenging test for class-D amplifiers. 6.67 kHz is the highest frequency in a 20-kHz band that can still show a second (13.13 kHz) and third (20 kHz) harmonic.

Figure 6. THD+N vs Power at 6.67 kHz
Table 8. TPA3245: 6.67-kHz Input

Output Power (W)	THD+N (dB)		
	Standard EVM	PFFB	Difference
0.01	-68.830	-74.306	-5.476
0.1	-77.840	-82.860	-5.020
1	-82.050	-86.783	-4.733
10	-75.523	-85.115	-9.592

8 THD+N vs Frequency

THD+N vs Frequency curves can supplement THD+N vs Power curves to see how the amplifier performs for all frequencies for a set power. This will ensure that the amplifier sounds good for all audible frequencies at a certain power level. Several power levels were used. The 1-W and 10-W power levels are important because they show how the amplifier performs at lower powers that are critical for how the amplifier sounds at typical room volumes. A 50-W power level is also taken to show high-power performance.

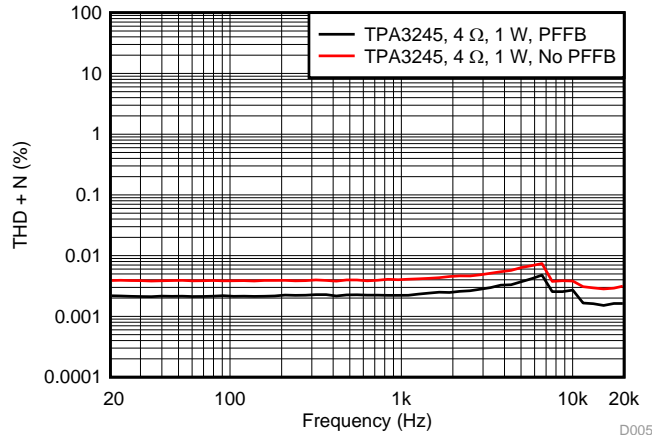

Figure 7. THD+N vs Frequency at 1 W

Table 9. TPA3245: 1 W

Frequency (Hz)	THD+N (dB)		
	Standard EVM	PFFB	Difference
20	-88.199	-93.202	-5.003
100	-88.284	-93.329	-5.045
1000	-87.888	-93.063	-5.176
10000	-88.355	-91.359	-3.003
15000	-90.919	-96.330	-5.411

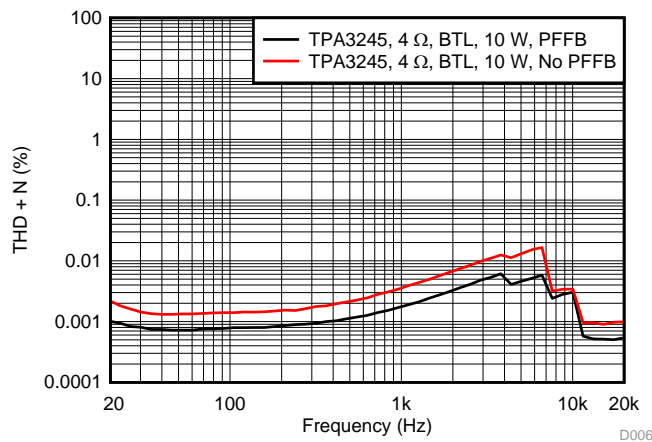

Figure 8. THD+N vs Frequency at 10 W

Table 10. TPA3245: 10 W

Frequency (Hz)	THD+N (dB)		
	Standard EVM	PFFB	Difference
20	-93.255	-99.900	-6.645
100	-97.083	-102.088	-5.005
1000	-88.966	-95.103	-6.137
10000	-82.290	-90.367	-1.077
15000	-100.874	-105.783	-4.908

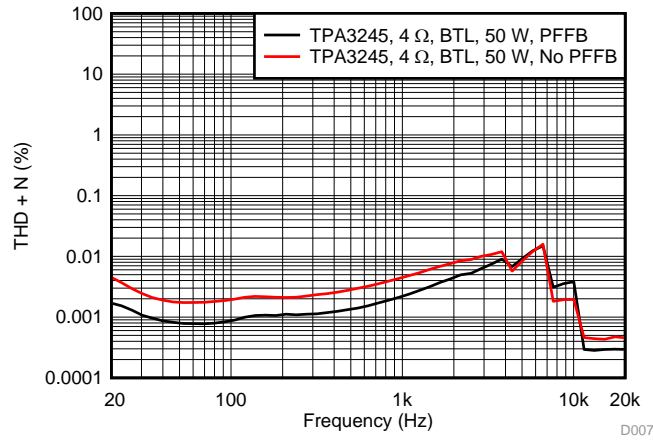

Figure 9. THD+N vs Frequency at 50 W

Table 11. TPA3245: 50 W

Frequency (Hz)	THD+N (dB)		
	Standard EVM	PFFB	Difference
20	-86.882	-95.380	-8.498
100	-94.246	-101.191	-6.945
1000	-86.941	-93.134	-6.193
10000	-94.173	-88.351	-5.823
15000	-107.281	-110.676	-3.395

9 SMPTE IMD

Intermodulation distortion (IMD) is an important element to measure on class-D amplifiers. IMD is created when two or more audio tones beat with one another in a non-linear device to produce undesired new tones. SMPTE IMD is a technique for measuring IMD according to the SMPTE RP120-1983 standard. This method of IMD uses a 60-Hz tone and a 7-kHz tone mixed at a 4:1 ratio. The harmonics of the 60-Hz tone are the primary ones measured. One useful way to view the distortion levels is to look at the sum of the harmonics vs output power. This can give you a sense of how much of the harmonics will be audible, and if that level gets significantly worse at high power.

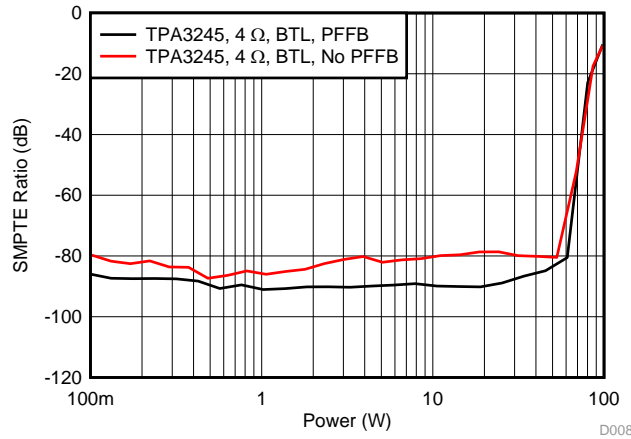

Figure 10. SMPTE IMD vs Power

Another useful view is to see all of the harmonics at a particular power level. Figure 11 and Figure 12 show the 1-W and 10-W SMPTE IMD. One can see that the second harmonic is very small for the standard configuration, and even lower with PFFB. Additionally, you can see that PFFB improves most harmonics at 1 W and 10 W.

Table 12. SMPTE Distortion Product Ratio

Frequency	60 Hz	6.76 kHz	6.82 kHz	6.88 kHz	6.94 kHz	7.00 kHz	7.06 kHz	7.12 kHz	7.18 kHz	7.24 kHz
	f1	d5	d4	d3	d2	f2	d2	d3	d4	d5

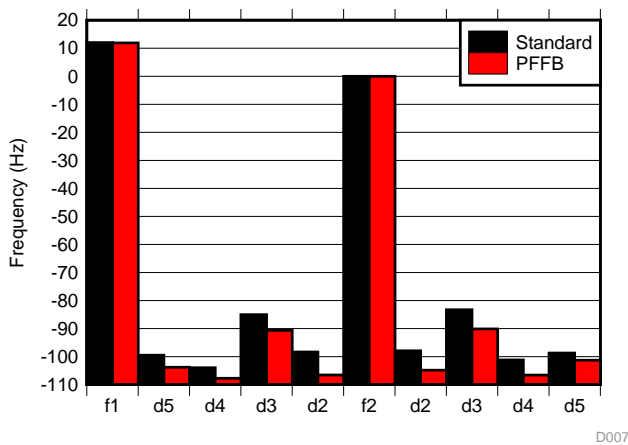

Figure 11. SMPTE IMD Distortion Product Ratio at 1 W

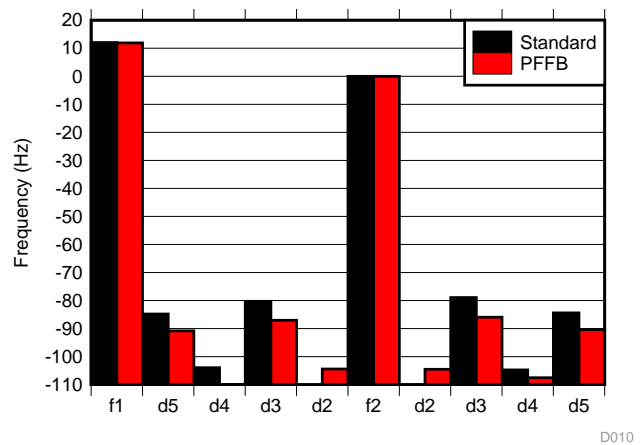

Figure 12. SMPTE IMD Distortion Product Ratio at 10 W

10 CCIF IMD

CCIF IMD is more sensitive to high-frequency nonlinearity; it mixes a 19-kHz and 20-kHz wave. CCIF IMD versus power is a way for to measure the high-frequency nonlinearity of the device across power.

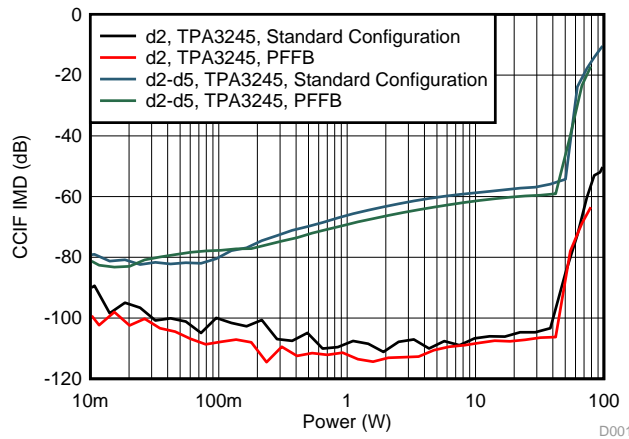

Figure 13. CCIF IMD vs Power

CCIF Distortion Product Ratio allows us to take a look at which harmonics are present, and at what level. The d2 product (1 kHz) is extremely important as it is easy to distinguish from the high frequency tones. The TPA324x and TPA325x family has excellent d2 distortion, and PFFB further improves distortion significantly below the audible level. The third and fifth harmonic (d3 and d5 respectively) are at higher levels, but since they are so close to the signal tones, they are hard to perceive. One can see that PFFB improves the system’s non-linearity and reduces d3 and d5 as well.

Table 13. CCIF Distortion Product Ratio

Frequency	1.00 kHz	2.00 kHz	17.00 kHz	18.00 kHz	19.00 kHz	20.00 kHz	21.00 kHz	22.00 kHz
	d2	d4	d5	d3	f1	f2	d3	d5

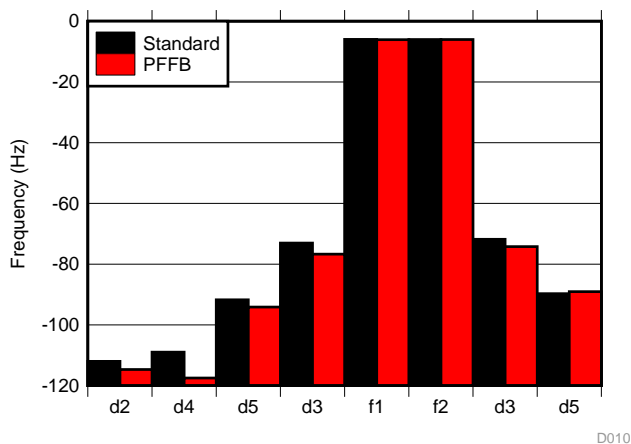

Figure 14. CCIF IMD Distortion Product Ratio at 1 W

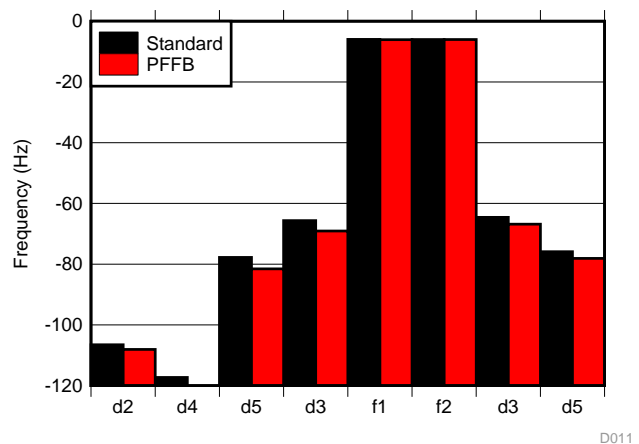

Figure 15. CCIF IMD Distortion Product Ratio at 10 W

11 Stability Analysis

Stability analysis is important for PFFB to insure that the added outer PFFB loop does not cause amplifier oscillations. With incorrectly selected PFFB component values, poor stability margins can cause the amplifier to oscillate. This can cause the amplifier to shut down and behave erratically, especially near clipping.

It is important to ensure the stability of the system for all conditions. For this reason, precautions must be taken to ensure that the TPA324x and TPA325x device is stable for open load conditions when using PFFB. For open load cases, the LC filter Q is extremely large. The Q factor of an LC filter will be affected by changes in the load resistance and an open load will cause an extremely large Q. The Zobel network is used to reduce the Q of the open load case by adding a resistance, or load, to the output. This reduction in the Q factor will reduce the output ringing. See [Figure 16](#).

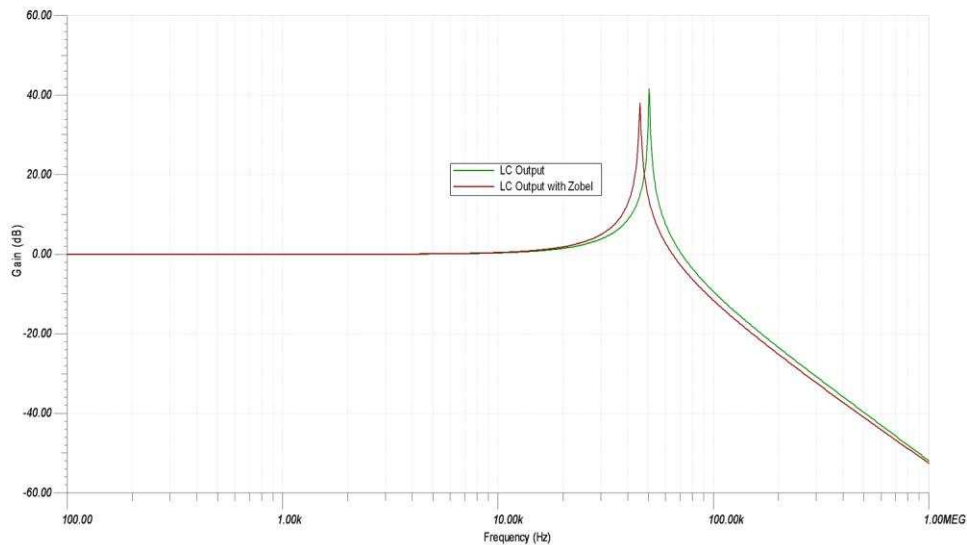

Figure 16. LC Filter Open Load Response – TINA Spice Simulation

By adding more capacitance to the Zobel capacitor, the response could be further improved, but there is a critical tradeoff. This RC network will be attached to the outputs of a high power amplifier. Therefore we must be mindful of the voltage across the capacitor and the current through the resistor. A calculation is done for the power dissipated in the Zobel resistor. The worst case here is a high frequency full scale signal. The audio band goes to 20 kHz, so that will be the worst case frequency. The output terminal to GND worst case is a full scale signal, thus PVDD is the worst case amplitude.

Table 14. Worst-Case Power Dissipation in Zobel Resistor

TPA3244 (PVDD=31.5, Fpwm=450 kHz)	TPA3245 (PVDD=31.5, Fpwm=600 kHz)	TPA3250 (PVDD=36 V, Fpwm=450kHz)	TPA3251 (PVDD=36 V, Fpwm=600 kHz)	TPA3255 (PVDD=51V , Fpwm=450 kHz)
P(R _z) (W)	P(R _z) (W)	P(R _z) (W)	P(R _z) (W)	P(R _z) (W)
0.095	0.095	0.124	0.124	0.273

By setting the Zobel capacitor to 220 nF, the worst case power dissipation is roughly ¼ W for the TPA3255, and 1/8 W for the TPA3250, TPA3251, TPA3244, and TPA3245. This allows users to use small, inexpensive components for the Zobel network.

The relationship between the Zobel capacitor value and the power dissipated for worst case is not linear. For example, for the TPA3255 case, if the Zobel capacitor was increased to 440 nF, the power dissipated in the resistor would be 1.09 W for worst case. If the Zobel capacitor was increased to 660 nF, the power dissipated would be 2.44 W.

For actual audio, there is less energy in higher frequencies. A 20-kHz full scale sine wave is a very rigorous test. For most audio applications, the Zobel resistor will dissipate very little power.

12 Stability Testing

There are a few tests that should be performed on any PFFB configuration:

- Test overshoot for a square wave input
- Test frequency response at full scale

13 Overshoot for Square Wave Input

The TPA324x and TPA325x amplifier family has an integrated feedback loop for noise suppression, which makes frequency domain gain and phase analysis for PFFB stability nearly impossible. Further complexity is added since the PFFB loop includes the phase and amplitude characteristics of the output LC filter where the internal feedback loop does not. For this reason, time domain overshoot analysis is the best means for assessing stability.

Using the TPA324x and TPA325x EVMs setup in BTL PFFB outlined in [Section 1](#), a 1-kHz square wave signal was input to the system. The amplifier output was monitored on an oscilloscope to capture the amount of overshoot from the rising edge of the input square wave. The amplifier output voltage of the square wave signal should be large enough for good resolution with the oscilloscope used for viewing the overshoot. However, the amplitude must not be large enough to approach clipping of the amplifier. The nonlinearity of clipping will give inaccurate results. For this test, a 3.3 V_{RMS} differential signal is input to the system.

Some oscilloscopes have the built in capability to measure overshoot. Overshoot can also be calculated using [Equation 4](#).

$$\text{Overshoot (\%)} = [(V_{\text{peak}}) - (V_{\text{ideal}})] / [(V_{\text{ideal}}) - (V_{\text{ss}})] \quad (4)$$

14 Calculating Phase Margin

After the overshoot percentage has been captured, the phase margin can be found. There are several methods to complete this. Users can use the Stability section of the [Analog Engineer's Calculator](#).

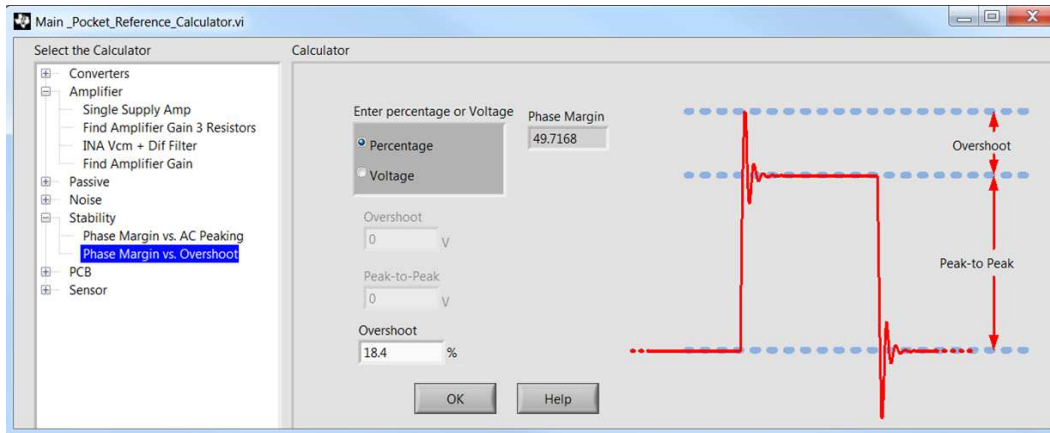

Figure 17. Phase Margin vs Overshoot Calculator of Analog Engineer

Alternatively, the curve in [Figure 18](#) can be used.

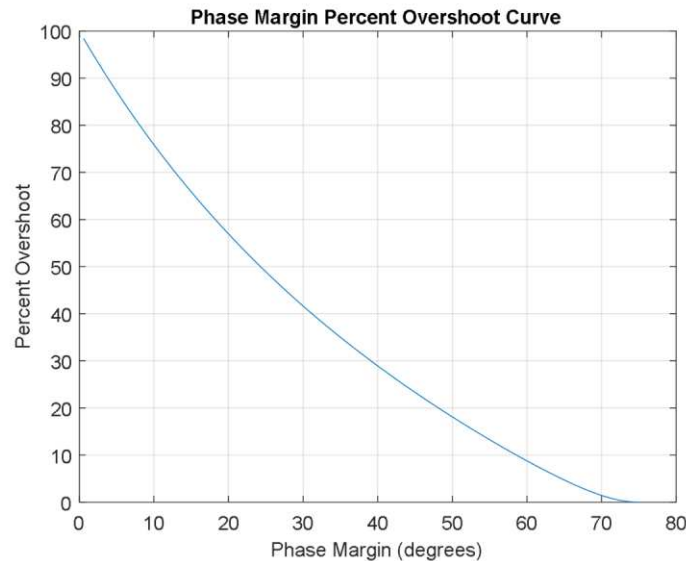

Figure 18. Phase Margin Percent Overshoot Curve

The curve in [Figure 18](#) was generated with the following code:

```
x = .27:.01:100;
pm = 90-(180/pi)*atan(x);
q=sqrt(x.*sqrt((1+x.^2)));
os=100*exp(-pi./(sqrt(4*q.^2-1)));
plot(pm,os)
title('Phase Margin Percent Overshoot Curve');
xlabel('Phase Margin (degrees)');
ylabel('Percent Overshoot');
grid;
```

The 1-kHz square wave test should be completed for possible loads the system will be subject to and an open load test. The goal is to evaluate the stability of the loop and determine if any oscillations are possible. By looking at a square wave, we can see the step response and determine how quickly the oscillations decay. If the oscillations do not decay quickly enough, the output could oscillate which could damage the device.

To complete the 1-kHz square wave test, first start with the worst case: open load. For a Class-D amplifier in PFFB, the most unstable condition is when the amplifier output is unloaded. Without a load, the Q of the LC filter will be extremely large. This quality factor extreme amplitude peaking at a frequency determined by the component values of the inductor (L) and capacitor (C). Furthermore, the higher the Q, the quicker phase will shift -180° for incremental increase in frequency, meaning the amplitude of the filter will still be very large when large phase shifts occurs; this causes instability.

If the amplifier is proven to have a stable open load, then the likelihood of stability issues when the amplifier output is loaded are reduced.

15 TPA3245 PFFB Stability

Using an oscilloscope, measure the signal after the LC filter with no load connected to the output. Supply a 1-kHz square wave signal to the amplifier input. Set the amplitude either to the maximum amplitude signal your system will supply or to the highest input that does not produce clipping, whichever is lower.

For example, a $3.3\text{-V}_{\text{RMS}}$ signal 1-kHz square wave signal is supplied to the TPA3245EVM with PFFB components installed before the output started clipping. [Figure 19](#) shows the output wave.

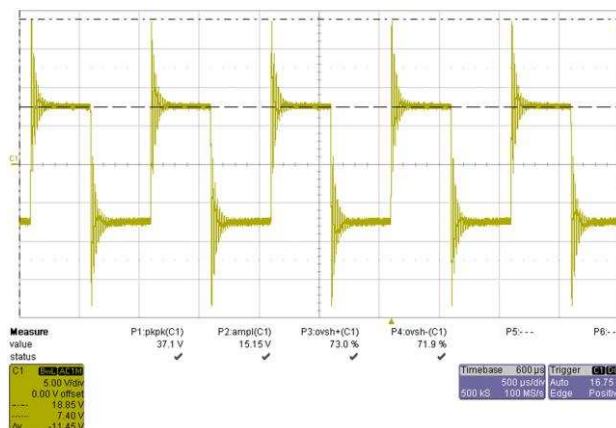

Figure 19. TPA3245 PFFB 1-kHz Square Wave Open Response

The scope images have an overshoot of 73%, and a phase margin of 11° .

The 11° is rather small, but this is a worst case test. It is also important to note how quickly the oscillations decay. This very quick decay points to good stability for the loop. Figure 20 shows the open load response to the TPA3245 without PFFB.

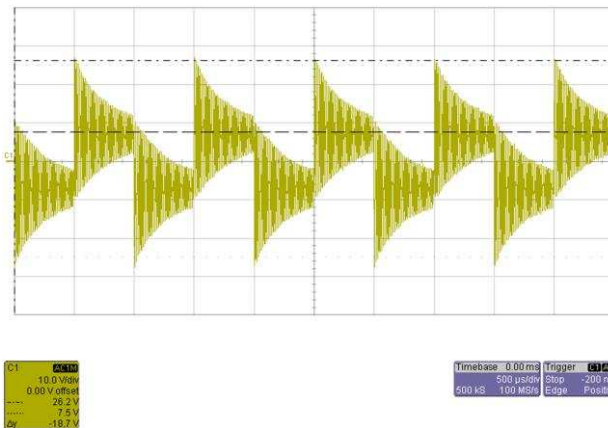

Figure 20. TPA3245 Standard Configuration 1-kHz Square Wave Open Response

The 1-kHz square wave then should be tested on all other loads the system is to support. Ensure that the load you are using is able to support the power the amplifier will be supplying. For the TPA3245, this is about 115 W for $4\ \Omega$ and 60 W for $8\ \Omega$.

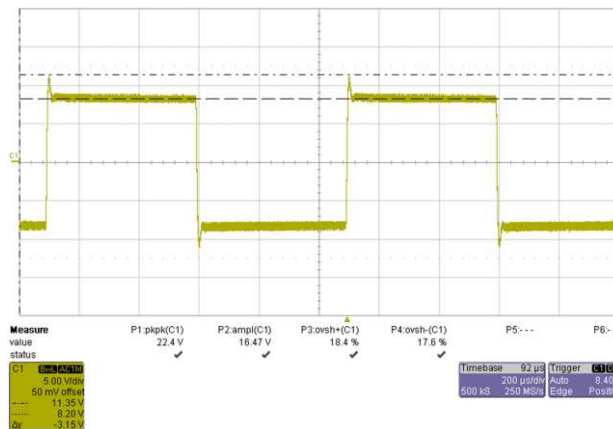

Figure 21. TPA3245 PFFB 1-kHz Square Wave $4\text{-}\Omega$ Response

With a $4\text{-}\Omega$ load, the output has an 18.4% overshoot and a phase margin of 50° .

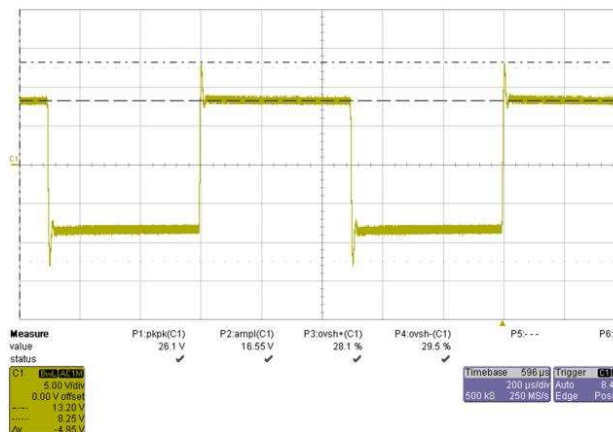

Figure 22. TPA3245 PFFB 1-kHz Square Wave $8\text{-}\Omega$ Response

The square wave tests for the TPA3250, TPA3251, TPA3245, TPA3244, and TPA3255 can be found in [Appendix A](#), [Appendix B](#), [Appendix C](#), [Appendix D](#), and [Appendix E](#).

16 Frequency Reponse at Full Scale

The frequency response of the device should also be tested to ensure that no signals inside the audio band can cause instability for the device. This should be done for open load, and all loads that the system is to support. This test should be done at the highest output voltage that the device is to support.

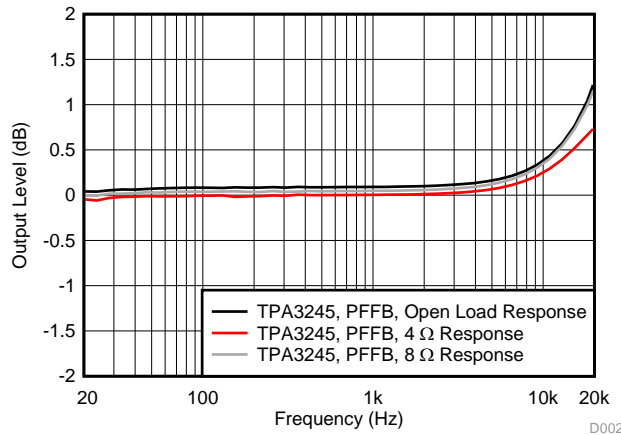

Figure 23. PFFB Audible Frequency Response

If a fault occurs during either one of these tests there is an issue with stability.

It is important to note this should be done for all frequencies this device is expected to pass. If, for some reason the amplifier will receive inputs outside of the audio range at high levels, this should be tested as well. The system is more likely to have stability issues at higher frequencies, especially for open load, due to the peaking of the LC filter. [Figure 24](#) shows the extended PFFB frequency response.

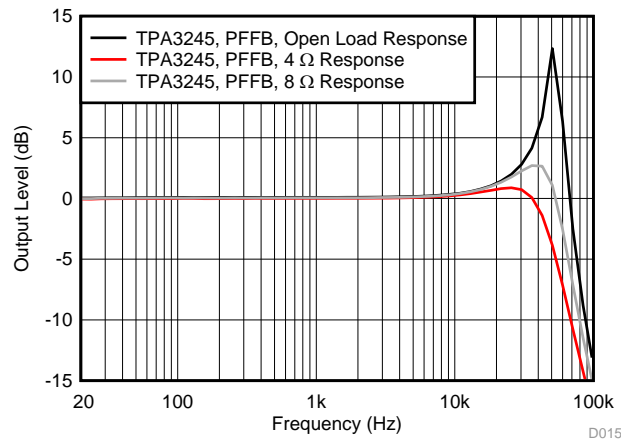

Figure 24. Extended PFFB Frequency Response

If the device passes the overshoot for a square wave input and the frequency response at full scale for all conditions of the audio system (PVDD voltage, loading conditions, temperature, and more), the system is considered stable.

TPA3244

A.1 TPA3244 EVM PFFB Test Results

Table 15. TPA3244 Summary

Parameter	Standard	PFFB
Gain (dB)	18	11.8
Negative feedback (dB)	0	6.2
Output noise (μV) A-weighted	54.5	29.5
SNR (dB) A-weighted	-111.4	-116.8
DNR (dB) A-weighted	-111.2	-117.1

A.2 TPA3244 THD+N vs Power

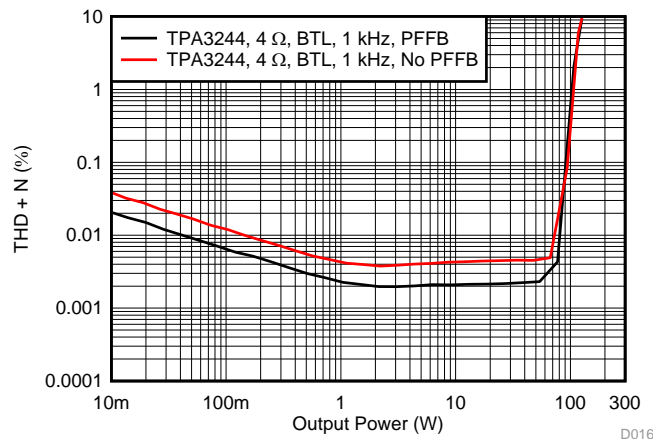

Figure 25. THD+N vs Power at 1 kHz

Table 16. TPA3244: 1 kHz

Output Power (W)	THD+N (dB)		
	Standard EVM	PFFB	Difference
0.01	-68.196	-73.677	-5.481
0.1	-78.298	-83.684	-5.386
1	-87.277	-92.770	-5.492
10	-87.343	-93.570	-6.226

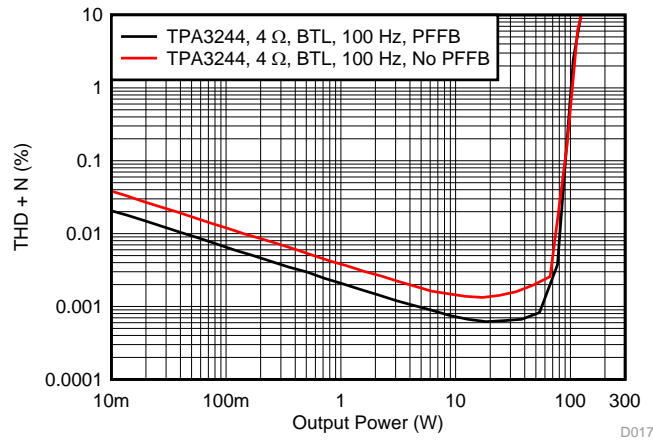

Figure 26. THD+N vs Power at 100 Hz

Table 17. TPA3244: 100 Hz

Output Power (W)	THD+N (dB)		
	Standard EVM	PFFB	Difference
0.01	-68.296	-73.695	-5.399
0.1	-78.380	-83.605	-5.226
1	-88.286	-93.599	-5.313
10	-96.775	-102.759	-5.985

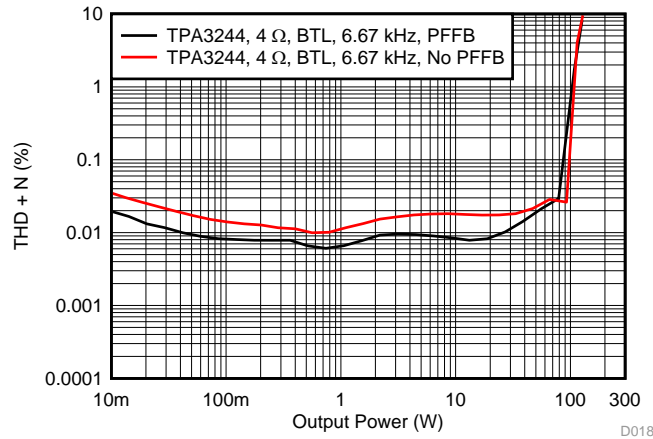

Figure 27. THD+N vs Power at 6.67 kHz

Table 18. TPA3244: 6.67 kHz

Output Power (W)	THD+N (dB)		
	Standard EVM	PFFB	Difference
0.01	-69.063	-74.142	-5.079
0.1	-77.034	-81.750	-4.717
1	-79.047	-83.735	-4.688
10	-74.878	-81.555	-6.677

A.3 TPA3244 THD+N vs Frequency

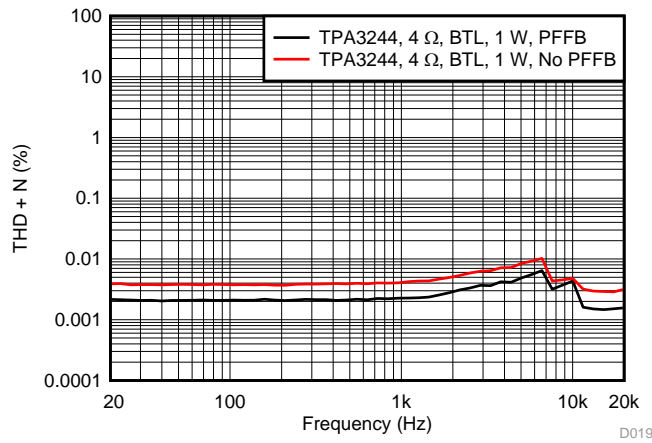

Figure 28. THD+N vs Frequency at 1 W

Table 19. TPA3244: 1 W

Frequency (Hz)	THD+N (dB)		
	Standard EVM	PFFB	Difference
20	-88.202	-93.291	-5.089
100	-88.468	-93.554	-5.086
1000	-87.740	-92.893	-5.152
10000	-86.427	-87.280	-0.854
15000	-90.679	-96.657	-5.977

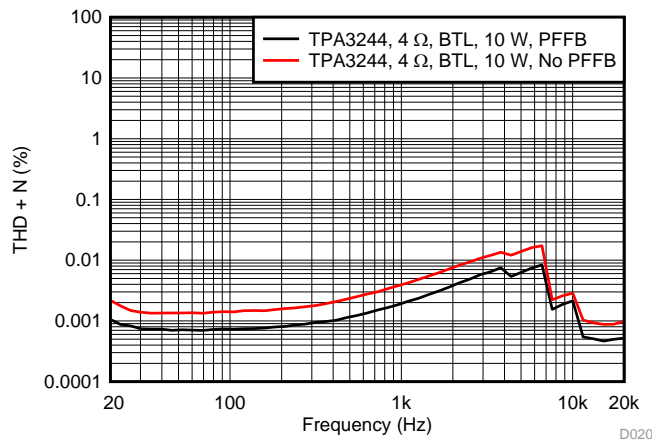

Figure 29. THD+N vs Frequency at 10 W

Table 20. TPA3244: 10 W

Frequency (Hz)	THD+N (dB)		
	Standard EVM	PFFB	Difference
20	-93.200	-99.457	-6.257
100	-97.002	-102.704	-5.702
1000	-88.101	-94.294	-6.193
10000	-90.901	-93.418	-2.517
15000	-101.101	-106.543	-5.442

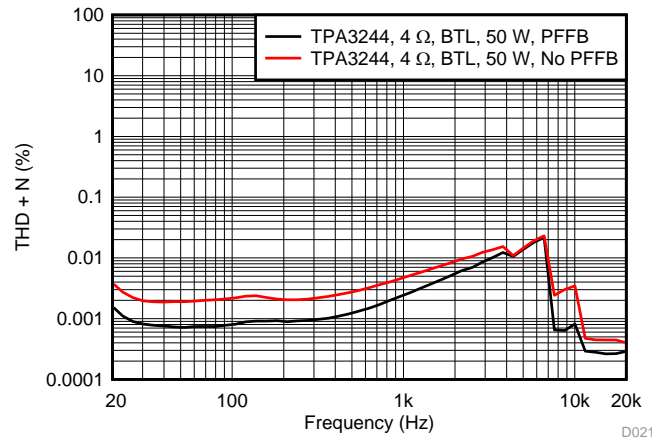

Figure 30. THD+N vs Frequency at 50 W

Table 21. TPA3244: 50 W

Frequency (Hz)	THD+N (dB)		
	Standard EVM	PFFB	Difference
20	-88.218	-95.958	-7.740
100	-93.263	-101.948	-8.685
1000	-86.504	-92.282	-5.779
10000	-89.209	-101.776	-12.567
15000	-107.020	-111.545	-4.525

A.4 TPA3244 SMPTE Distortion Product Ratio

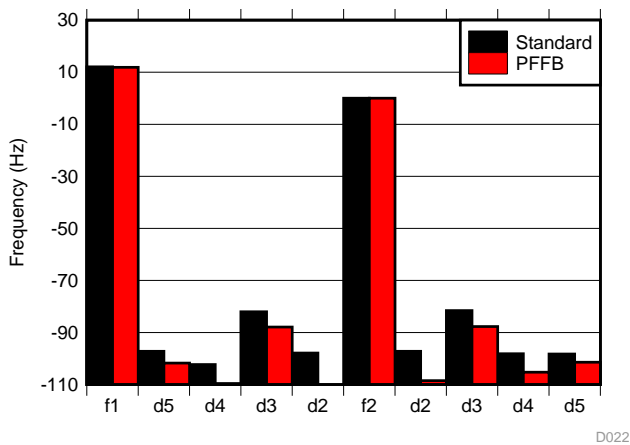

Figure 31. SMPTE IMD – TPA3244 at 1 W

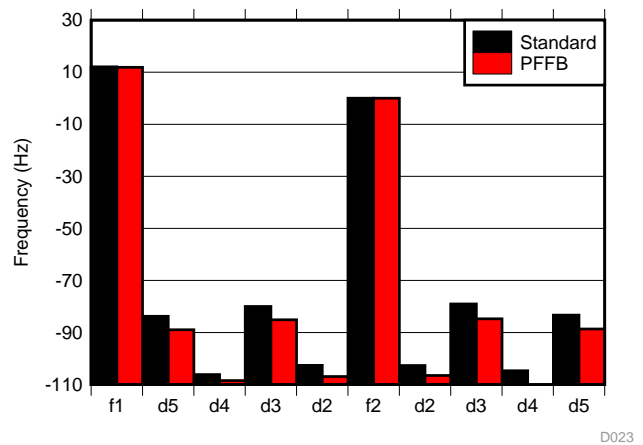

Figure 32. SMPTE IMD – TPA3244 at 10 W

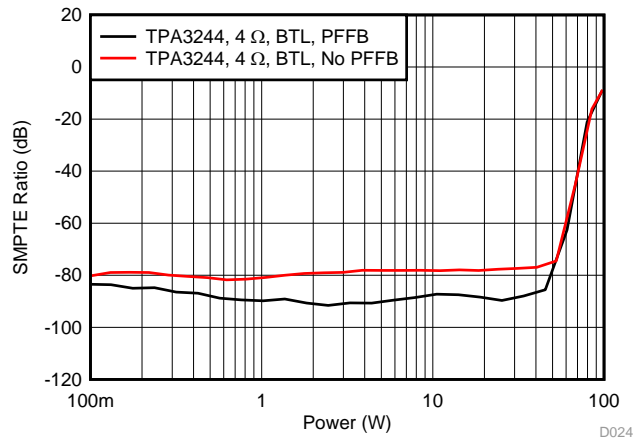

Figure 33. SMPTE Ratio vs Output Power

A.5 TPA3244 CCIF Distortion Product Ratio

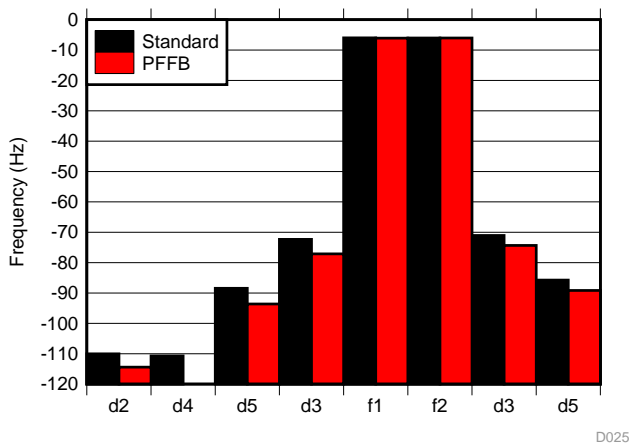

Figure 34. CCIF IMD – TPA3244 at 1 W

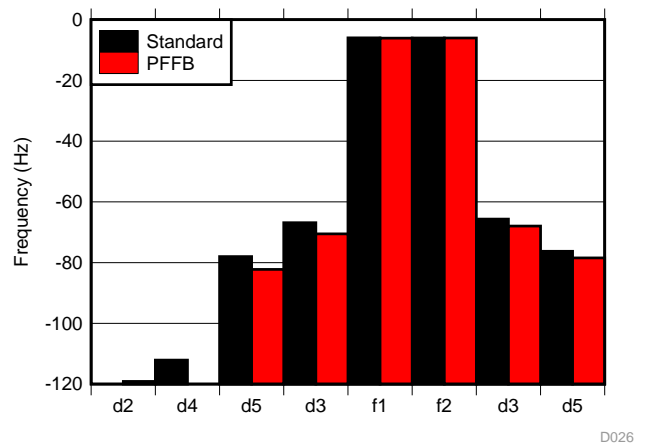

Figure 35. CCIF IMD – TPA3244 at 10 W

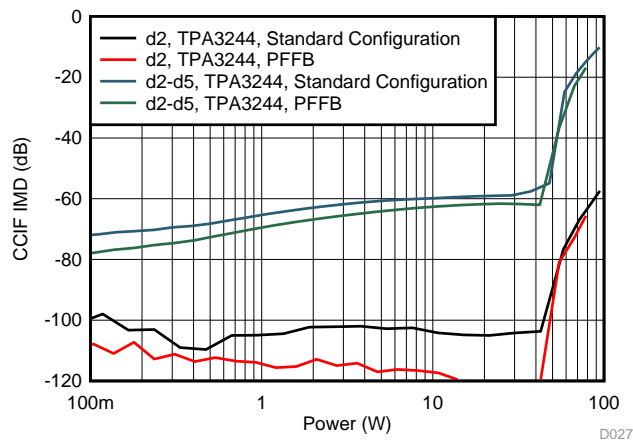

Figure 36. CCIF Response

A.6 TPA3244 Stability Analysis

Table 22. TPA3244 – PFFB

Load (Ω)	Overshoot (%)	Phase Margin (degrees)
OL	77.9	9.1
4	19.1	49.0
8	36.3	34.0

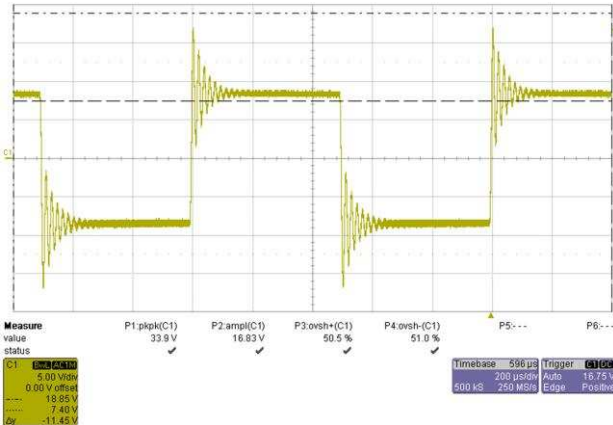

Figure 37. TPA3244 PFFB – Open-Load Response

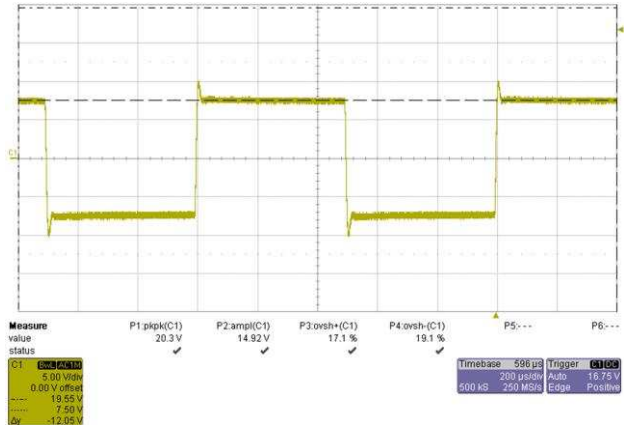

Figure 38. TPA3244 PFFB – 4- Ω Response

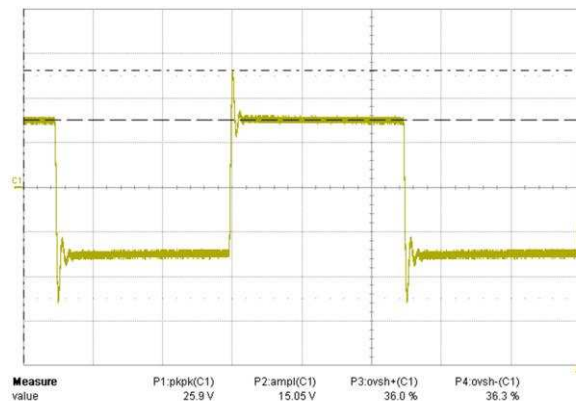

Figure 39. TPA3244 PFFB – 8- Ω Response

TPA3245

B.1 TPA3245 EVM PFFB Test Results

Table 23. TPA3245 Summary

Parameter	Standard	PFFB
Gain (dB)	18	11.8
Negative feedback (dB)	0	6.2
Output noise (μ V) A-weighted	54.4	28.7
SNR (dB) A-weighted	-111.5	-116.8
DNR (dB) A-weighted	-111.5	-116.9

B.2 THD+N vs Power

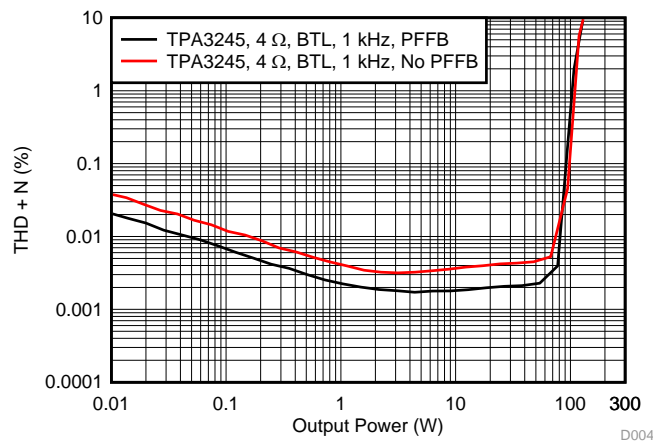
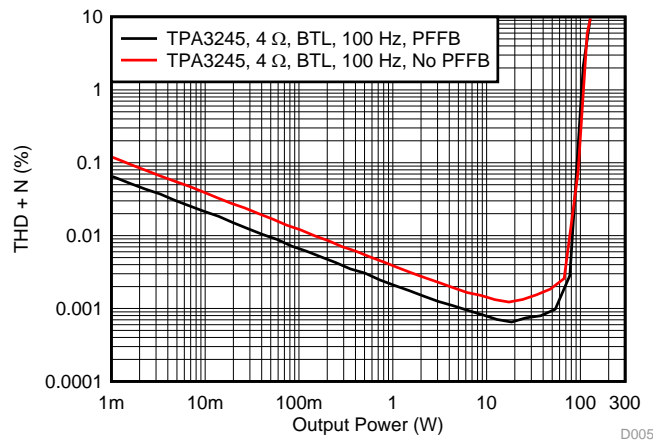

Figure 40. THD+N vs Power at 1 kHz

Table 24. TPA3245: 1-kHz Input

Output Power	THD+N (dB)		
	Standard EVM	PFFB	Difference
0.01	-68.383	-73.669	-5.28
0.1	-78.305	-83.263	-4.958
1	-87.610	-92.844	-5.234
10	-88.768	-94.845	-6.076

Figure 41. THD+N vs Power at 100 Hz
Table 25. TPA3245: 100-Hz Input

Output Power	THD+N (dB)		
	Standard EVM	PFFB	Difference
0.01	-68.211	-73.418	-5.208
0.1	-78.243	-83.479	-5.236
1	-88.141	-93.446	-5.304
10	-96.802	-102.021	-5.219

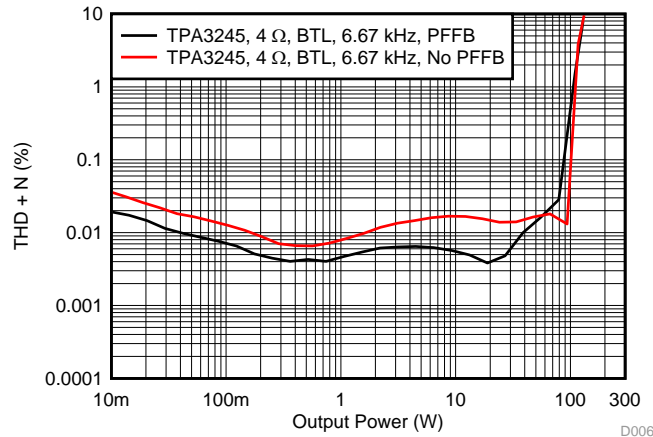
Figure 42. THD+N vs Power at 6.67 kHz
Table 26. TPA3245: 6.67-kHz Input

Output Power	THD+N (dB)		
	Standard EVM	PFFB	Difference
0.01	-68.830	-74.306	-5.476
0.1	-77.840	-82.860	-5.020
1	-82.050	-86.783	-4.733
10	-75.523	-85.115	-9.592

B.3 THD+N vs Frequency

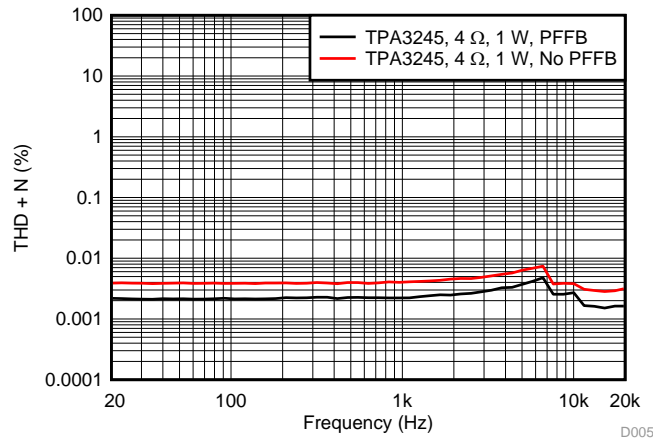

Figure 43. THD+N vs Frequency at 1 W

Table 27. TPA3245: 1 W

Frequency	THD+N (dB)		
	Standard EVM	PFFB	Difference
20	-88.199	-93.202	-5.003
100	-88.284	-93.329	-5.045
1000	-87.888	-93.063	-5.176
10000	-88.355	-91.359	-3.003
15000	-90.919	-96.330	-5.411

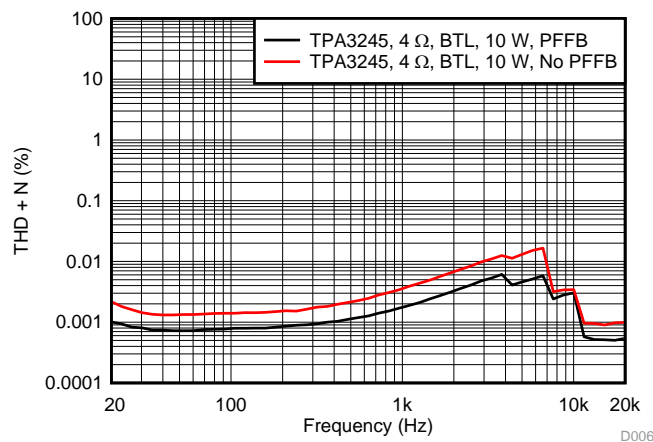

Figure 44. THD+N vs Frequency at 10 W

Table 28. TPA3245: 10 W

Frequency	THD+N (dB)		
	Standard EVM	PFFB	Difference
20	-93.255	-99.900	-6.645
100	-97.083	-102.088	-5.005
1000	-88.966	-95.103	-6.137
10000	-82.290	-90.367	-1.077
15000	-100.874	-105.783	-4.908

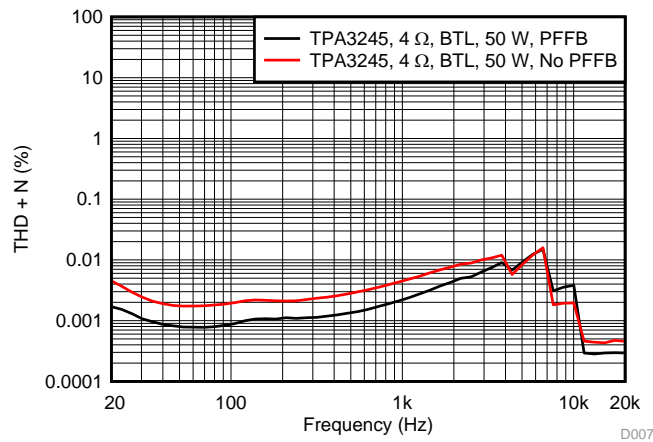

Figure 45. THD+N vs Frequency at 50 W

Table 29. TPA3245: 50 W

Frequency	THD+N (dB)		
	Standard EVM	PFFB	Difference
20	-86.882	-95.380	-8.498
100	-94.246	-101.191	-6.945
1000	-86.941	-93.134	-6.193
10000	-94.173	-88.351	-5.823
15000	-107.281	-110.676	-3.395

B.4 TPA3245 – SMPTE Distortion Product Ratio

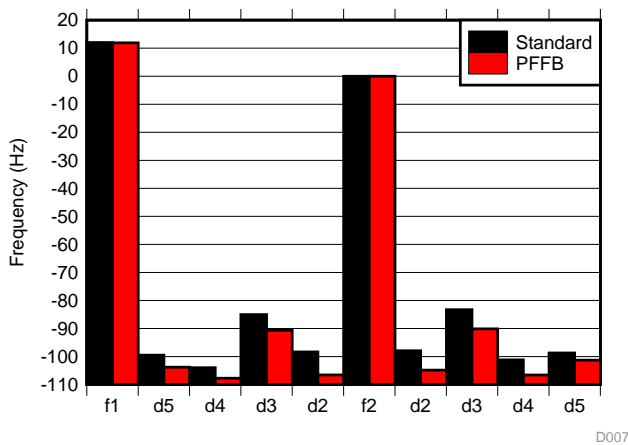

Figure 46. SMPTE IMD Distortion Product Ratio at 1 W

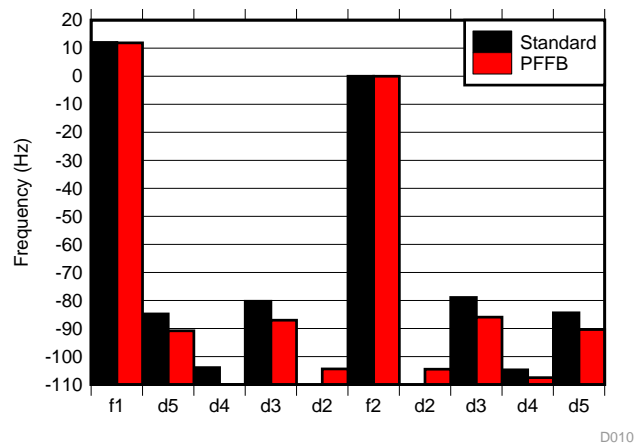

Figure 47. SMPTE IMD Distortion Product Ratio at 10 W

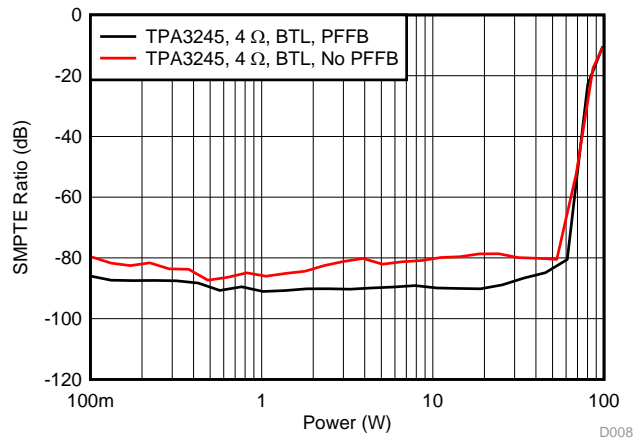

Figure 48. SMPTE IMD vs Power

B.5 TPA3245 – CCIF Distortion Product Ratio

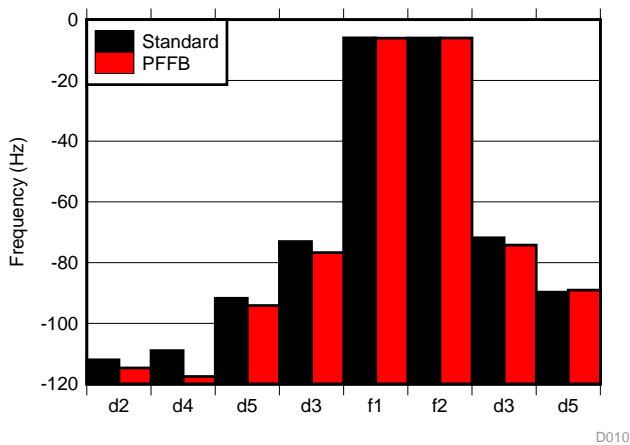

Figure 49. CCIF IMD Distortion Product Ratio at 1 W

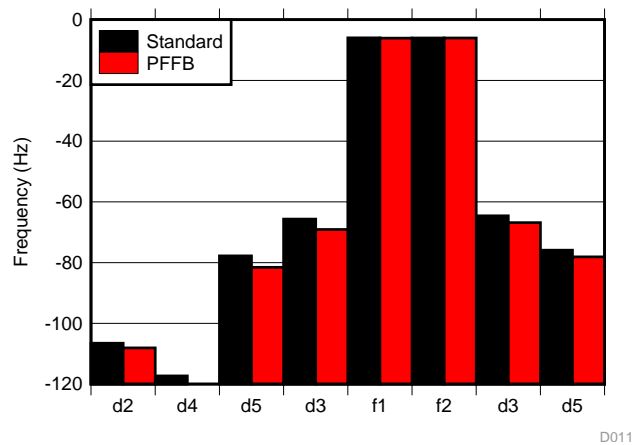

Figure 50. CCIF IMD Distortion Product Ratio at 10 W

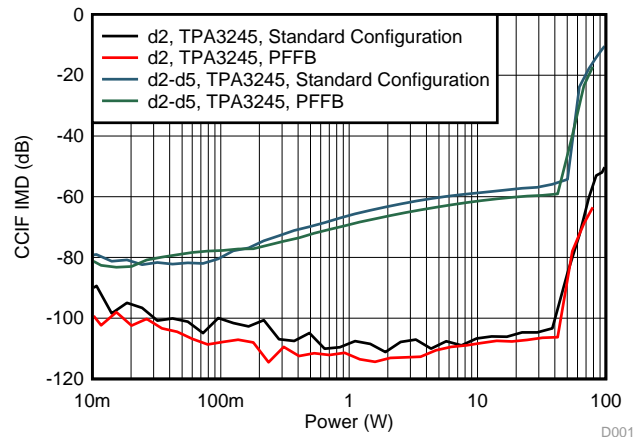

Figure 51. CCIF IMD vs Power

B.6 TPA3245 Stability Analysis

Table 30. TPA3245 – PFFB

Load (Ω)	Overshoot (%)	Phase Margin (degrees)
OL	73.0	11.4
4	18.1	50.0
8	35.0	35.0

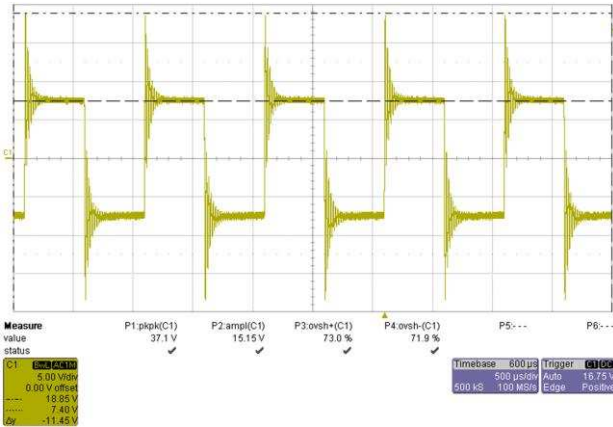

Figure 52. TPA3245 PFFB – Open-Load Response

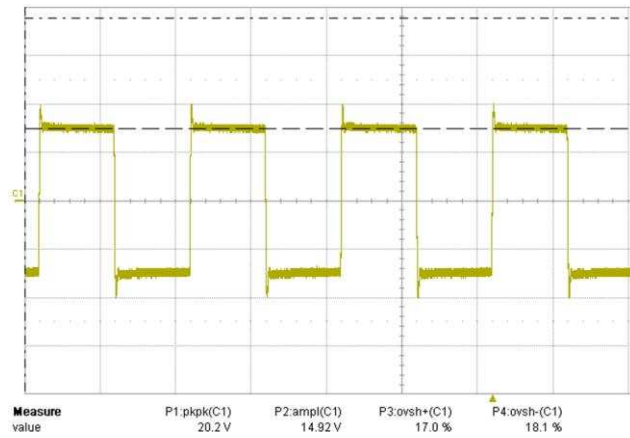

Figure 53. TPA3245 PFFB – 4- Ω Response

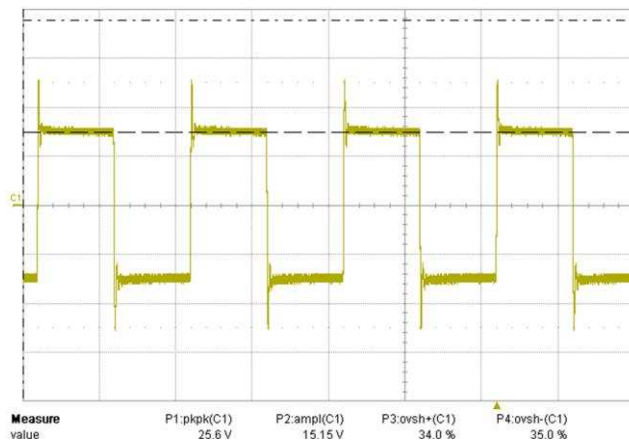

Figure 54. TPA3245 PFFB – 8- Ω Response

TPA3250

C.1 TPA3250 EVM PFFB Test Results

Table 31. TPA3245 Summary

Parameter	Standard	PFFB
Gain (dB)	20	12.75
Negative feedback (dB)	0	7.25
Output noise (μ V) A-weighted	62.7	30.5
SNR (dB) A-weighted	-111.3	-117.4
DNR (dB) A-weighted	-111.1	-117.5

C.2 TPA3250 THD+N vs Power

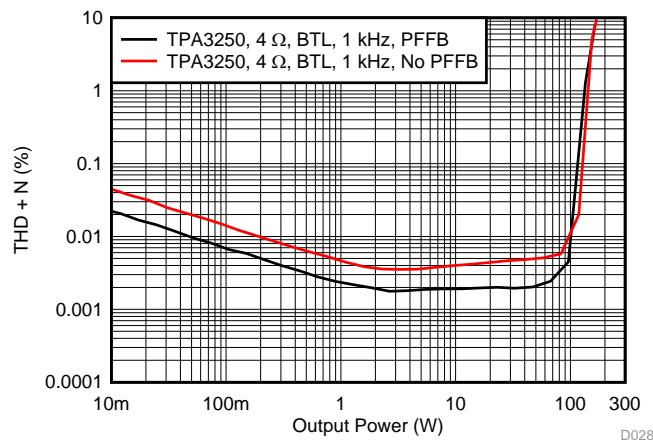

Figure 55. THD+N vs Power at 1 kHz

Table 32. TPA3250: 1-kHz Input

Output Power (W)	THD+N (dB)		
	Standard EVM	PFFB	Difference
0.01	-66.926	-72.981	-6.055
0.1	-76.911	-83.258	-6.348
1	-86.555	-92.542	-5.987
10	-87.940	-94.371	-6.432

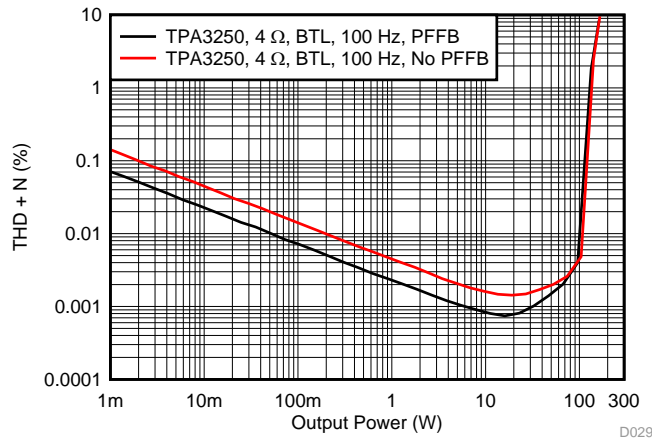

Figure 56. THD+N vs Power at 100 Hz

Table 33. TPA3250: 100-Hz Input

Output Power (W)	THD+N (dB)		
	Standard EVM	PFFB	Difference
0.01	-66.918	-72.774	-5.856
0.1	-76.941	-82.786	-5.845
1	-86.885	-92.682	-5.797
10	-95.880	-101.513	-5.633

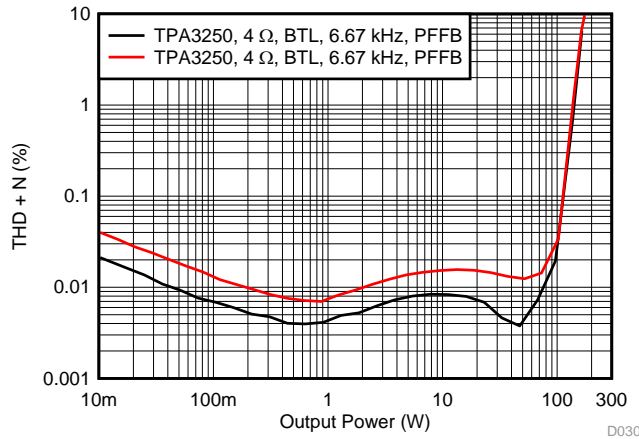

Figure 57. THD+N vs Power at 6.67 kHz

Table 34. TPA3250: 6.67-kHz Input

Output Power (W)	THD+N (dB)		
	Standard EVM	PFFB	Difference
0.01	-67.796	-73.258	-5.462
0.1	-77.577	-83.145	-5.568
1	-82.605	-87.324	-4.719
10	-76.296	-81.575	-5.279

C.3 TPA3250 THD+N vs Frequency

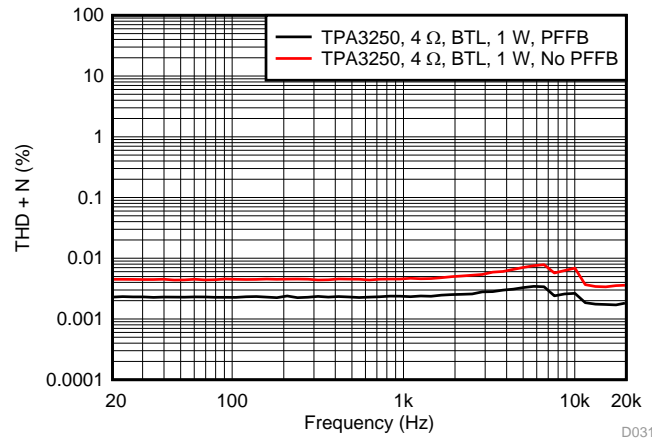

Figure 58. THD+N vs Frequency at 1 W

Table 35. TPA3250: 1 W

Frequency (Hz)	THD+N (dB)		
	Standard EVM	PFFB	Difference
20	-86.917	-92.803	-5.885
100	-86.898	-92.881	-5.983
1000	-86.771	-92.529	-5.759
10000	-83.247	-91.568	-8.321
15000	-89.403	-95.218	-5.815

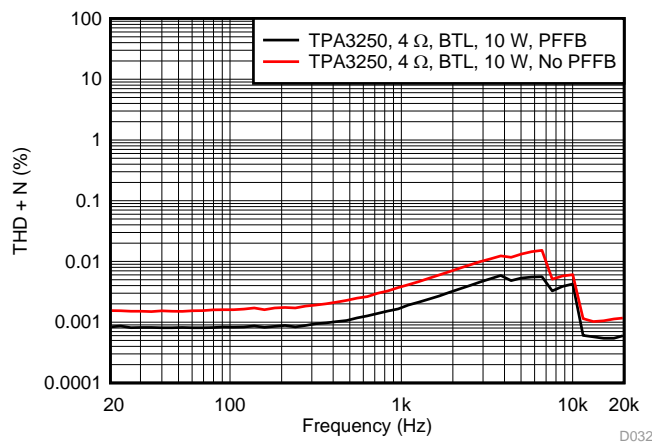

Figure 59. THD+N vs Frequency at 10 W

Table 36. TPA3250: 10 W

Frequency (Hz)	THD+N (dB)		
	Standard EVM	PFFB	Difference
20	-96.172	-101.561	-5.388
100	-95.899	-101.641	-5.742
1000	-88.297	-95.230	-6.933
10000	-84.369	-87.426	-3.057
15000	-99.568	-105.261	-5.693

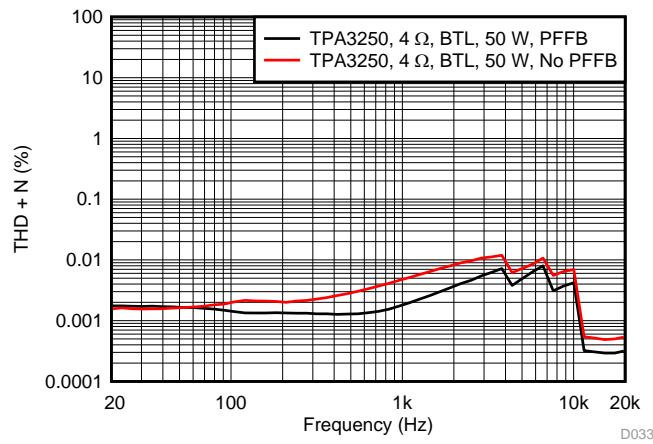

Figure 60. THD+N vs Frequency at 50 W

Table 37. TPA3245: 50 W

Frequency (Hz)	THD+N (dB)		
	Standard EVM	PFFB	Difference
20	-96.174	-95.165	1.009
100	-94.061	-96.871	-2.810
1000	-86.436	-94.864	-8.428
10000	-83.185	-87.548	-4.363
15000	-106.203	-110.651	-4.448

C.4 TPA3250 – SMPTE Distortion Product Ratio

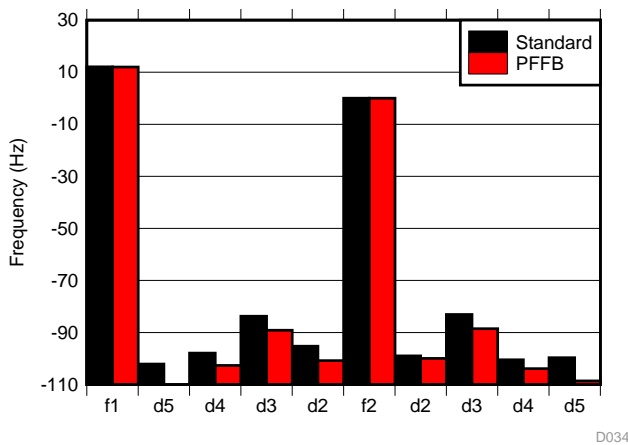

Figure 61. SMPTE IMD Distortion Product Ratio at 1 W

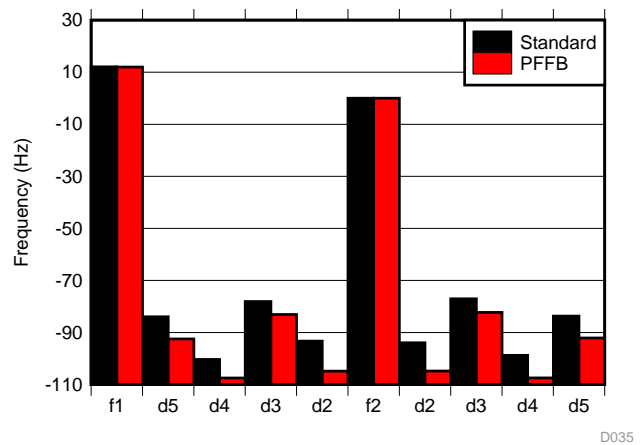

Figure 62. SMPTE IMD Distortion Product Ratio at 10 W

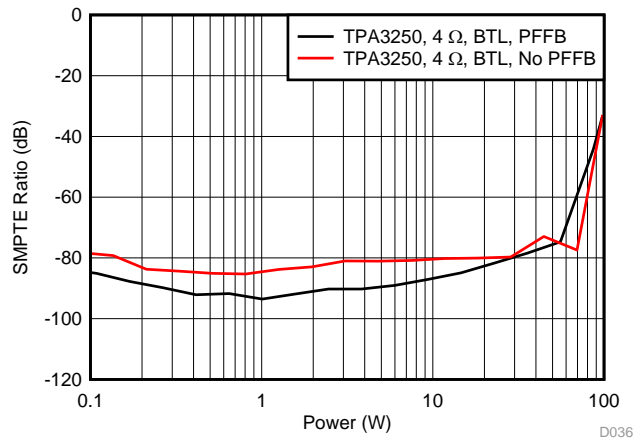

Figure 63. SMPTE IMD vs Power

C.5 TPA3250 – CCIF Distortion Product Ratio

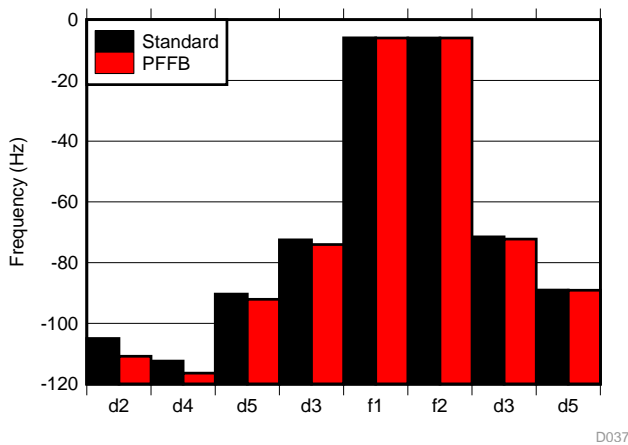

Figure 64. CCIF IMD Distortion Product Ratio at 1 W

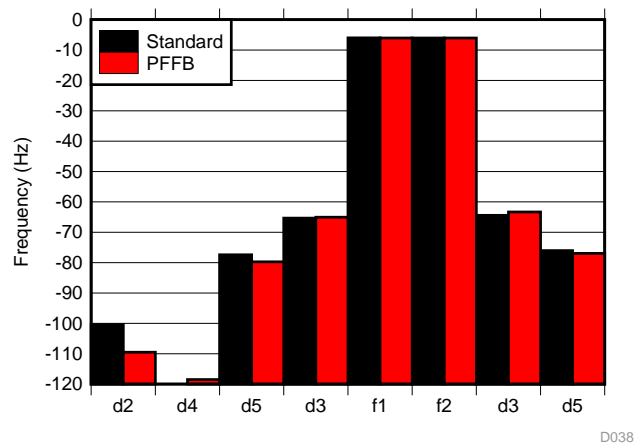

Figure 65. CCIF IMD Distortion Product Ratio at 10 W

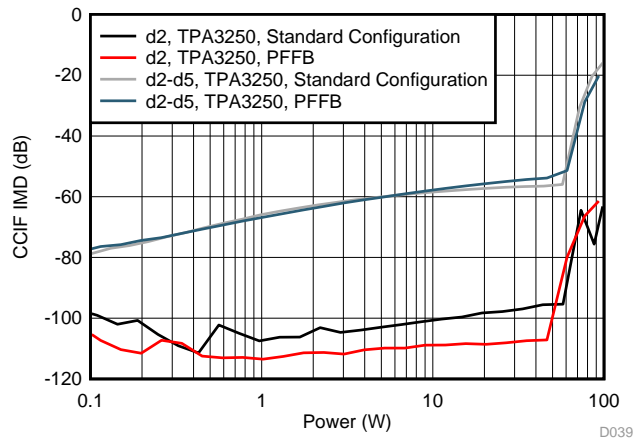

Figure 66. CCIF IMD vs Power

C.6 TPA3250 Stability Analysis

Table 38. TPA3250 – PFFB

Load (Ω)	Overshoot (%)	Phase Margin (degrees)
OL	51.0	23.7
4	18.4	49.7
8	29.5	39.5

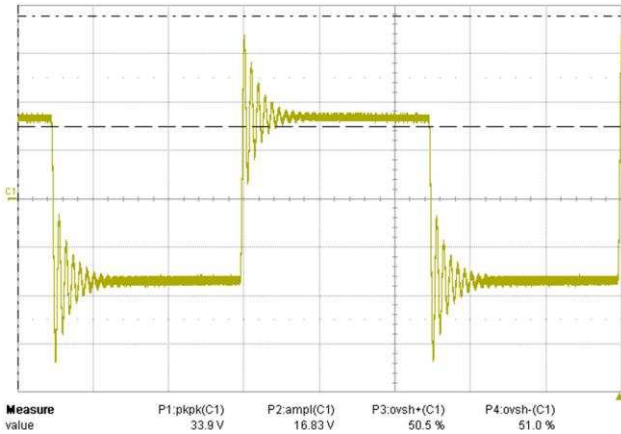

Figure 67. TPA3250 PFFB – Open-Load Response

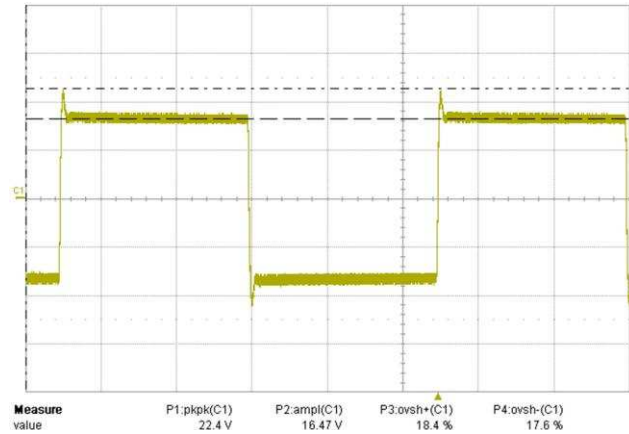

Figure 68. TPA3250 PFFB – 4- Ω Response

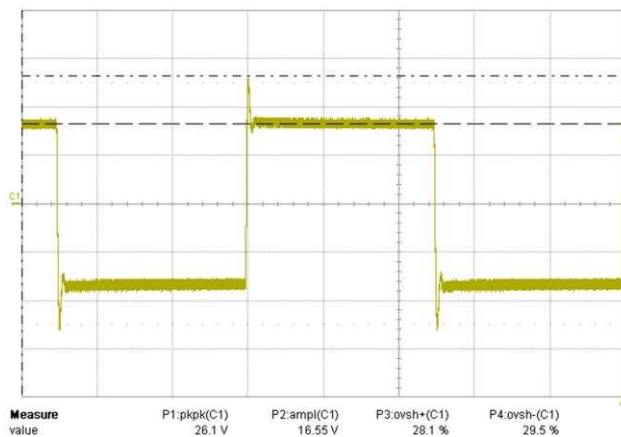

Figure 69. TPA3250 PFFB – 8- Ω Response

TPA3251

D.1 TPA3251 EVM PFFB Test Results

Table 39. TPA3251 Summary

Parameter	Standard	PFFB
Gain (dB)	20	12.75
Negative feedback (dB)	0	7.25
Output noise (μ V) A-weighted	61.4	28.3
SNR (dB) A-weighted	-111.8	-117.8
DNR (dB) A-weighted	-111.6	-117.6

D.2 TPA3251 THD+N vs Power

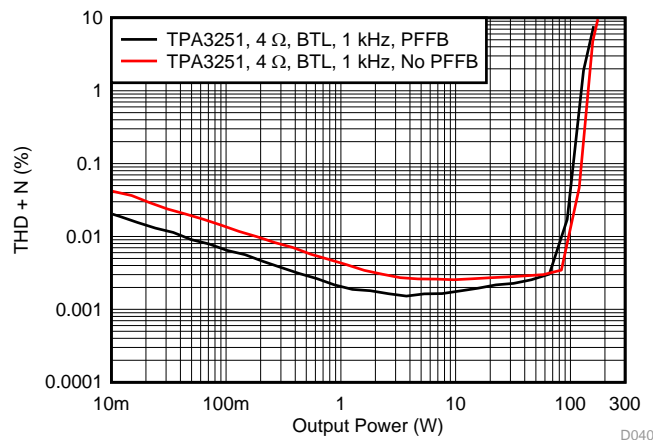

Figure 70. THD+N vs Power at 1 kHz

Table 40. TPA3251: 1-kHz Input

Output Power (W)	THD+N (dB)		
	Standard EVM	PFFB	Difference
0.01	-67.339	-73.622	-6.283
0.1	-77.261	-83.708	-6.447
1	-87.187	-93.660	-6.473
10	-91.852	-95.140	-3.288

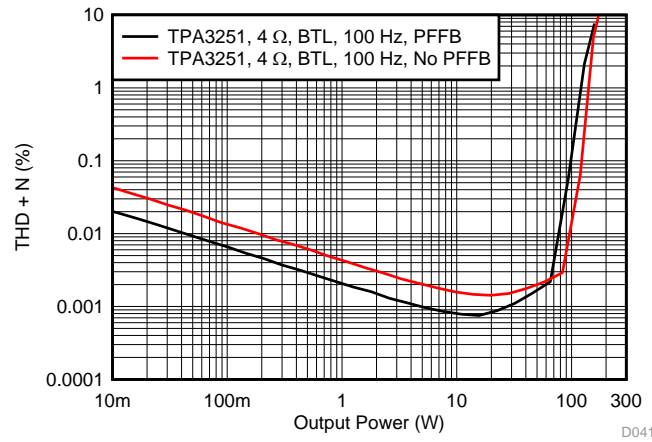

Figure 71. THD+N vs Power at 100 Hz

Table 41. TPA3251: 100-Hz Input

Output Power (W)	THD+N (dB)		
	Standard EVM	PFFB	Difference
0.01	-67.305	-73.801	-6.496
0.1	-77.372	-83.615	-6.243
1	-87.228	-93.610	-6.382
10	-96.038	-101.894	-5.856

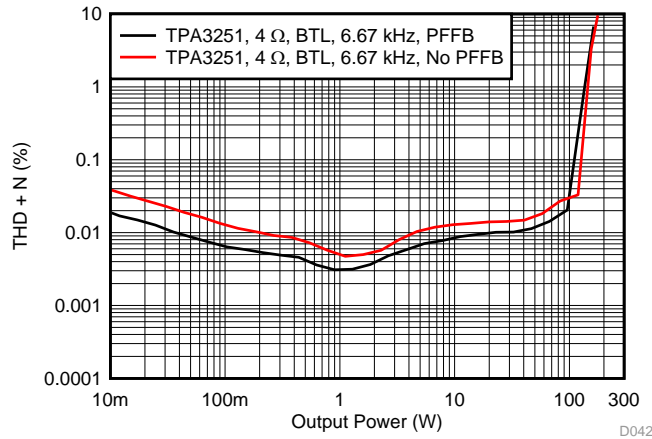

Figure 72. THD+N vs Power at 6.67 kHz

Table 42. TPA3251: 6.67-kHz Input

Output Power (W)	THD+N (dB)		
	Standard EVM	PFFB	Difference
0.01	-68.200	-74.304	-6.104
0.1	-77.788	-83.742	-5.954
1	-85.894	-90.153	-4.258
10	-77.789	-81.460	-3.670

D.3 THD+N vs Frequency

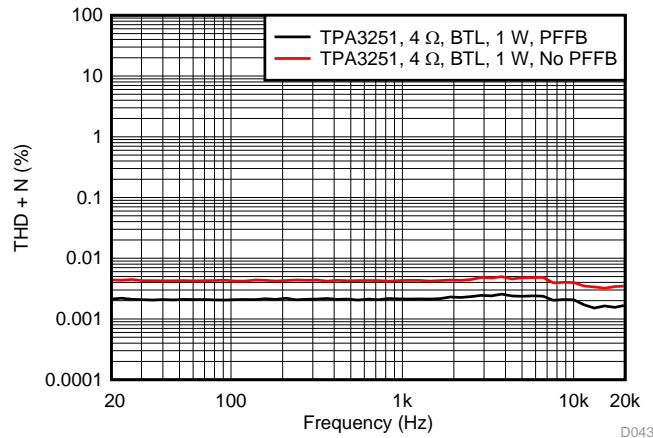

Figure 73. THD+N vs Frequency at 1 W

Table 43. TPA3251: 1 W

Frequency (Hz)	THD+N (dB)		
	Standard EVM	PFFB	Difference
20	-87.132	-93.440	-6.308
100	-87.398	-93.682	-6.284
1000	-87.331	-93.405	-6.074
10000	-88.003	-93.690	-5.687
15000	-89.834	-95.767	-5.933

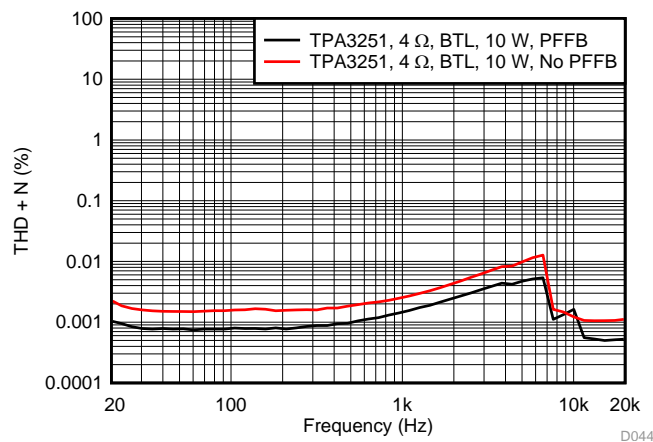

Figure 74. THD+N vs Frequency at 10 W

Table 44. TPA3251: 10 W

Frequency (Hz)	THD+N (dB)		
	Standard EVM	PFFB	Difference
20	-92.789	-99.585	-6.796
100	-96.070	-102.051	-5.981
1000	-91.882	-96.705	-4.823
10000	-98.215	-95.809	2.406
15000	-99.487	-106.007	-6.520

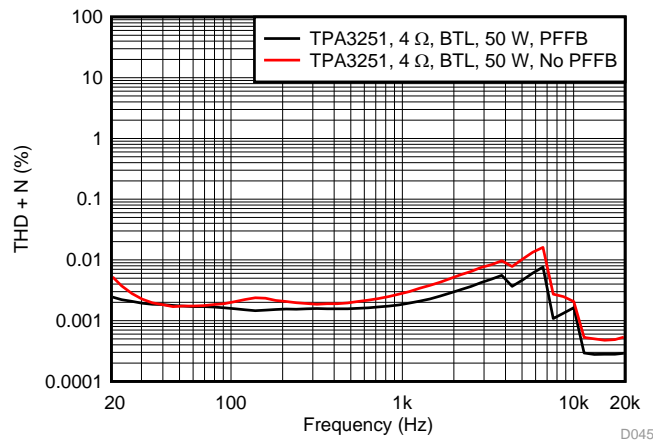

Figure 75. THD+N vs Frequency at 50 W

Table 45. TPA3251: 50 W

Frequency (Hz)	THD+N (dB)		
	Standard EVM	PFFB	Difference
20	-85.180	-92.110	-6.930
100	-93.986	-95.960	-1.974
1000	-90.983	-94.627	-3.644
10000	-93.689	-95.777	-2.088
15000	-106.407	-111.074	-4.667

D.4 TPA3251 – SMPTE Distortion Product Ratio

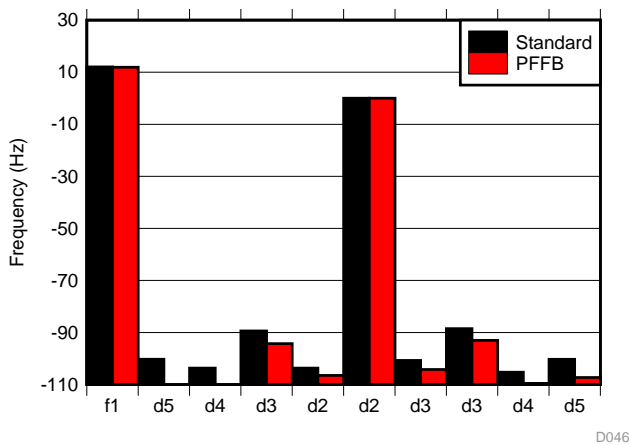

Figure 76. SMPTE IMD Distortion Product Ratio at 1 W

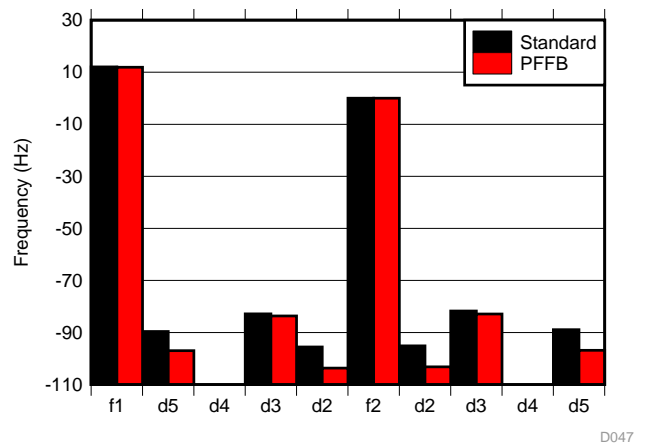

Figure 77. SMPTE IMD Distortion Product Ratio at 10 W

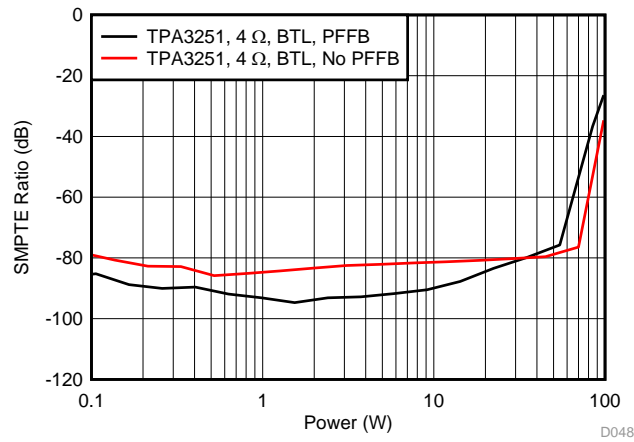

Figure 78. SMPTE IMD vs Power

D.5 TPA3251 – CCIF Distortion Product Ratio

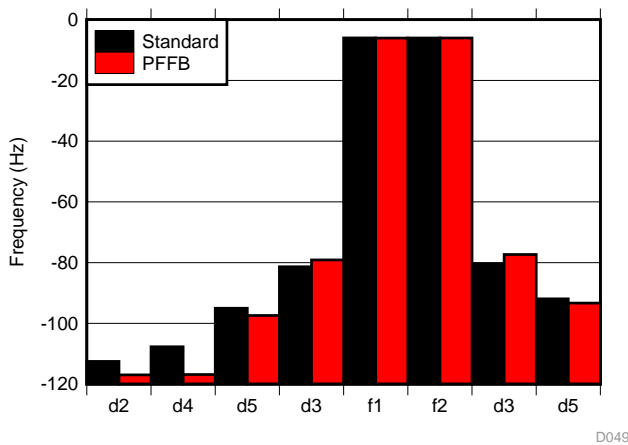

Figure 79. CCIF IMD Distortion Product Ratio at 1 W

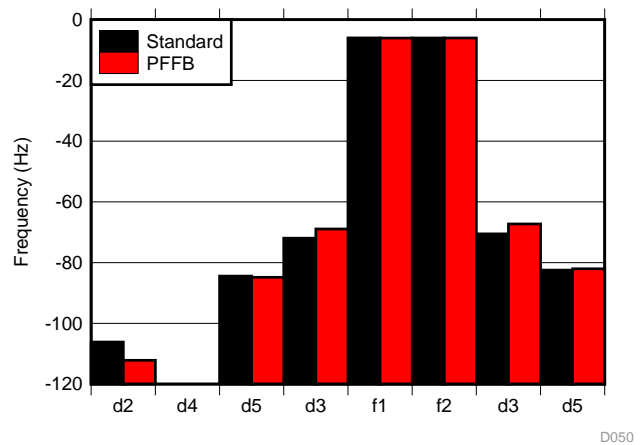

Figure 80. CCIF IMD Distortion Product Ratio at 10 W

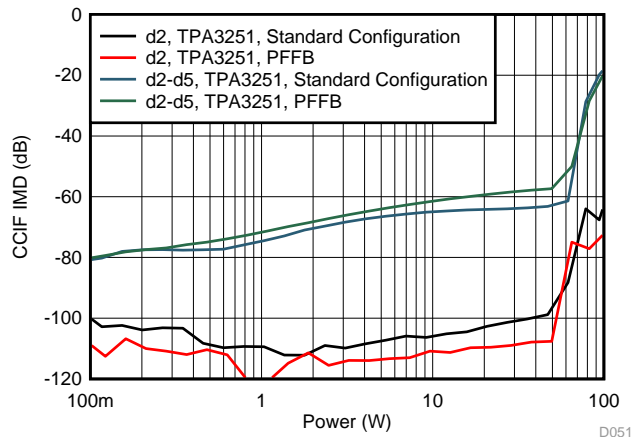

Figure 81. CCIF IMD vs Power

D.6 TPA3251 Stability Analysis

Table 46. TPA3245 – PFFB

Load (Ω)	Overshoot (%)	Phase Margin (degrees)
OL	59.8	18.3
4	18.4	49.7
8	29.5	39.5

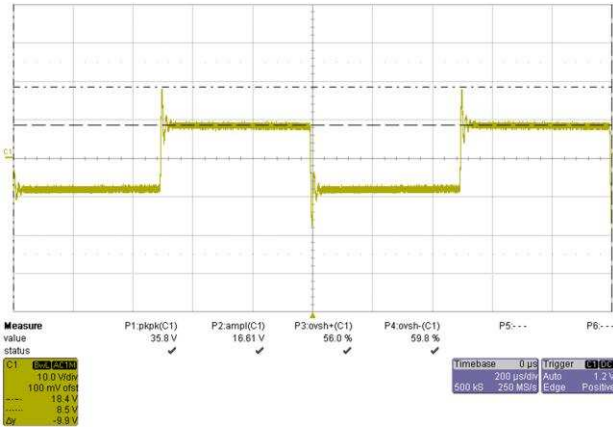

Figure 82. TPA3251 PFFB – Open-Load Response

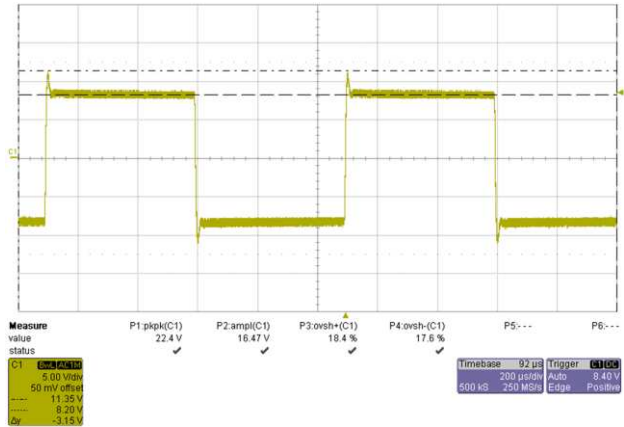

Figure 83. TPA3251 PFFB – 4- Ω Response

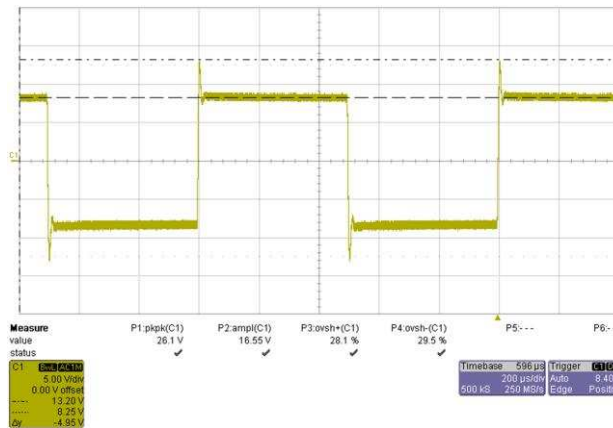

Figure 84. TPA3251 PFFB – 8- Ω Response

TPA3255

E.1 TPA3255 EVM PFFB Test Results

Table 47. TPA3255 Summary

Parameter	Standard	PFFB
Gain (dB)	21.5	15.9
Negative feedback (dB)	0	5.6
Output noise (μ V) A-weighted	81.5	46.2
SNR (dB) A-weighted	-111.9	-116.5
DNR (dB) A-weighted	-111.9	-116.5

E.2 TPA3255 THD+N vs Power

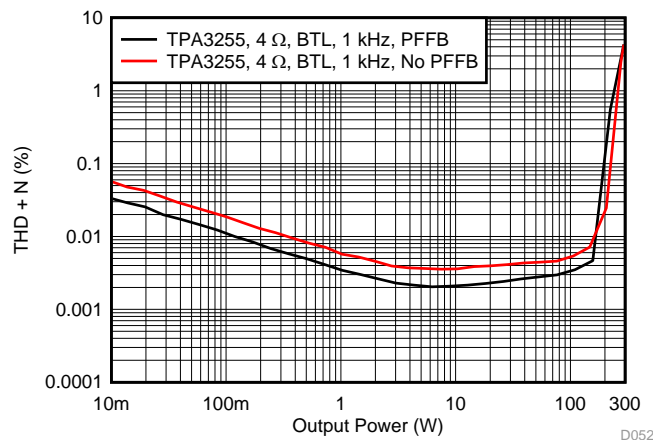

Figure 85. THD+N vs Power at 1 kHz

Table 48. TPA3255: 1-kHz Input

Output Power (W)	THD+N (dB)		
	Standard EVM	PFFB	Difference
0.01	-64.882	-69.511	-4.630
0.1	-74.564	-78.990	-4.426
1	-84.682	-89.125	-4.443
10	-88.905	-93.545	-4.640
100	-85.619	-89.501	-3.882

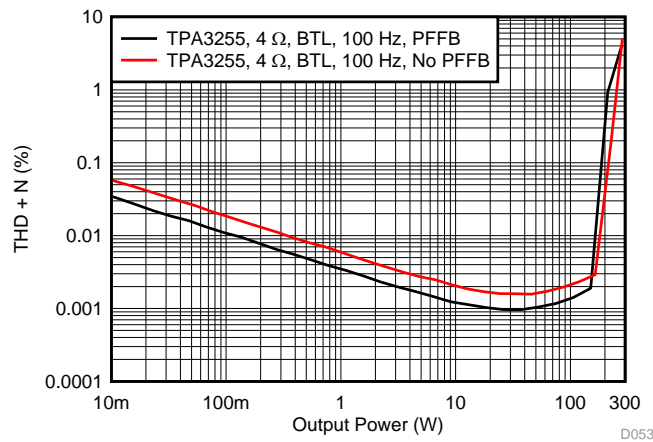

Figure 86. THD+N vs Power at 100 Hz

Table 49. TPA3255: 100-Hz Input

Output Power (W)	THD+N (dB)		
	Standard EVM	PFFB	Difference
0.01	-64.597	-69.091	-4.494
0.1	-74.605	-79.294	-4.690
1	-84.516	-89.081	-4.564
10	-93.713	-98.335	-4.622
100	-93.498	-97.274	-3.776

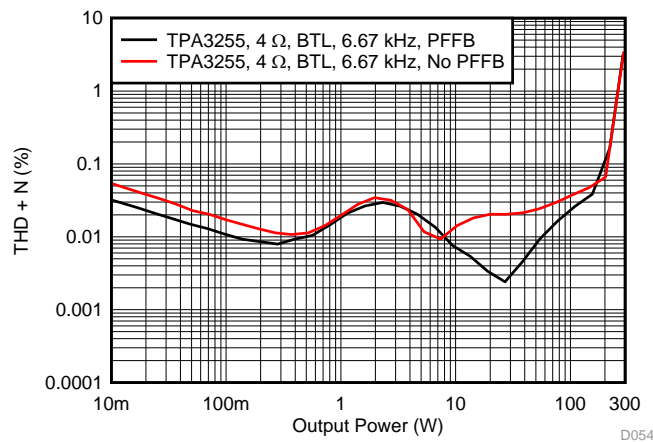

Figure 87. THD+N vs Power at 6.67 kHz

Table 50. TPA3255: 6.67-kHz Input

Output Power (W)	THD+N (dB)		
	Standard EVM	PFFB	Difference
0.01	-65.289	-69.784	-4.495
0.1	-75.323	-79.352	-4.029
1	-74.158	-74.714	-0.556
10	-77.214	-82.780	-5.565
100	-68.772	-72.664	-3.892

E.3 THD+N vs Frequency

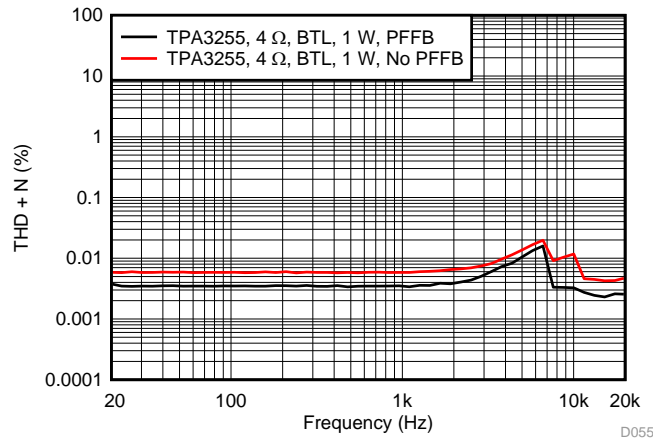

Figure 88. THD+N vs Frequency at 1 W

Table 51. TPA3255: 1 W

Frequency (Hz)	THD+N (dB)		
	Standard EVM	PFFB	Difference
20	-84.620	-88.456	-3.836
100	-84.644	-89.132	-4.488
1000	-84.682	-89.176	-4.494
10000	-78.621	-89.730	-11.109
15000	-87.372	-92.690	-5.319

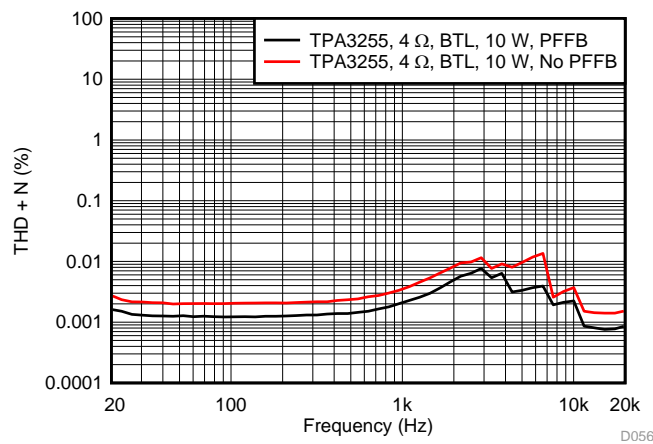

Figure 89. THD+N vs Frequency at 10 W

Table 52. TPA3255: 10 W

Frequency (Hz)	THD+N (dB)		
	Standard EVM	PFFB	Difference
20	-91.195	-95.764	-4.569
100	-93.794	-98.257	-4.464
1000	-89.108	-93.560	-4.452
10000	-88.629	-92.993	-4.364
15000	-97.007	-102.332	-5.324

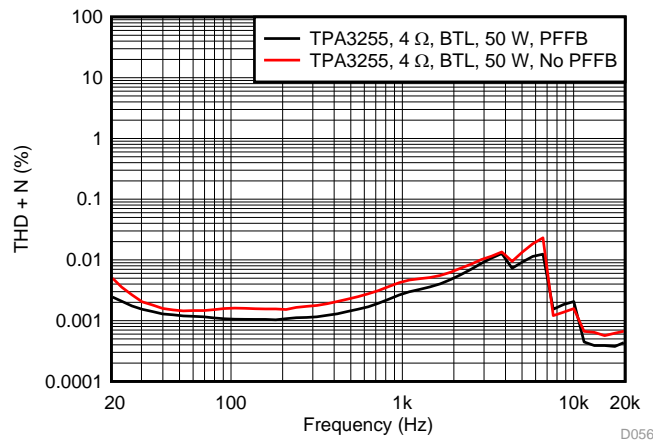

Figure 90. THD+N vs Frequency at 50 W

Table 53. TPA3255: 50 W

Frequency (Hz)	THD+N (dB)		
	Standard EVM	PFFB	Difference
20	-85.610	-92.025	-6.415
100	-95.919	-99.465	-3.545
1000	-87.237	-91.221	-3.984
10000	-96.057	-93.741	2.316
15000	-104.838	-108.176	-3.338

E.4 TPA3255 – SMPTE Distortion Product Ratio

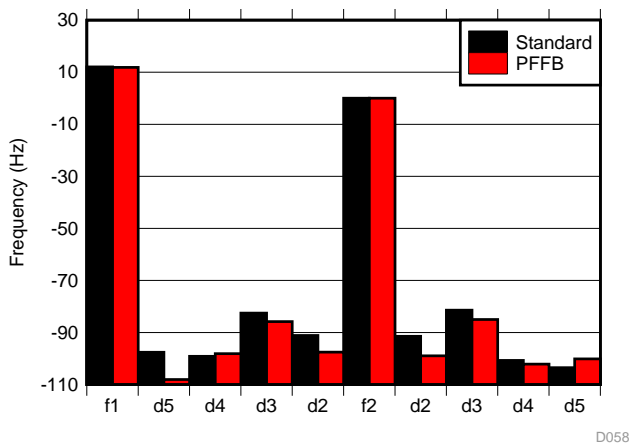

Figure 91. SMPTE IMD Distortion Product Ratio at 1 W

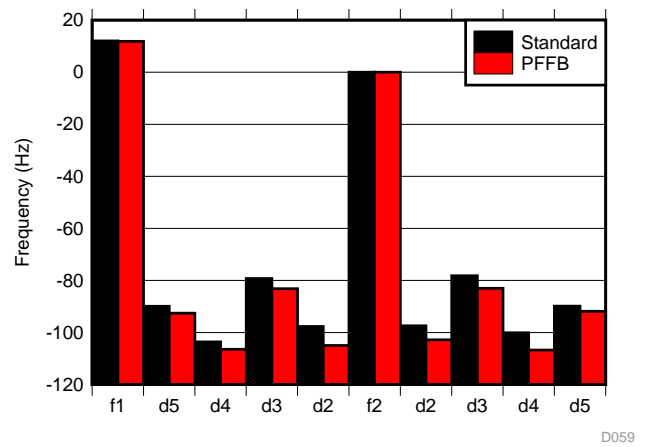

Figure 92. SMPTE IMD Distortion Product Ratio at 10 W

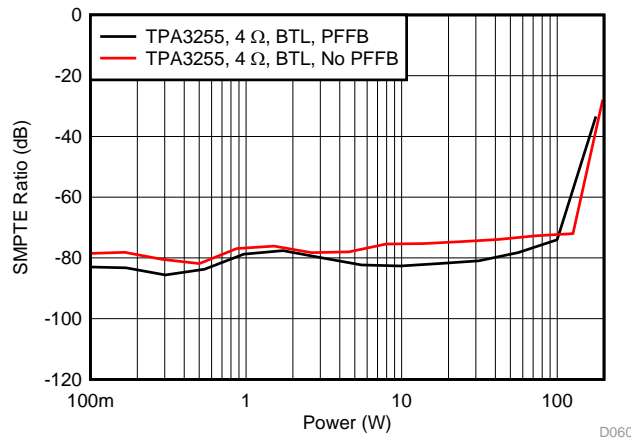

Figure 93. SMPTE IMD vs Power

E.5 TPA3245 – CCIF Distortion Product Ratio

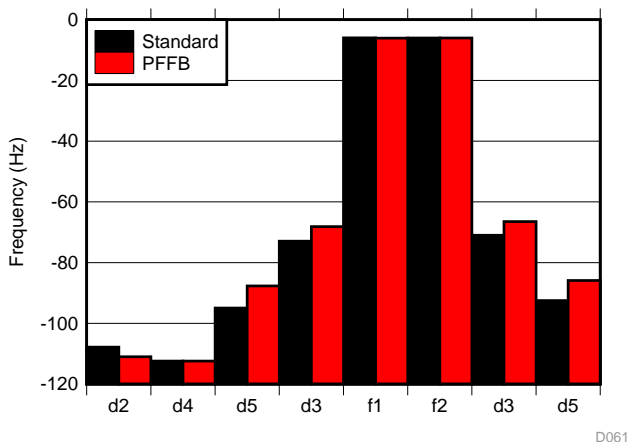

Figure 94. CCIF IMD Distortion Product Ratio at 1 W

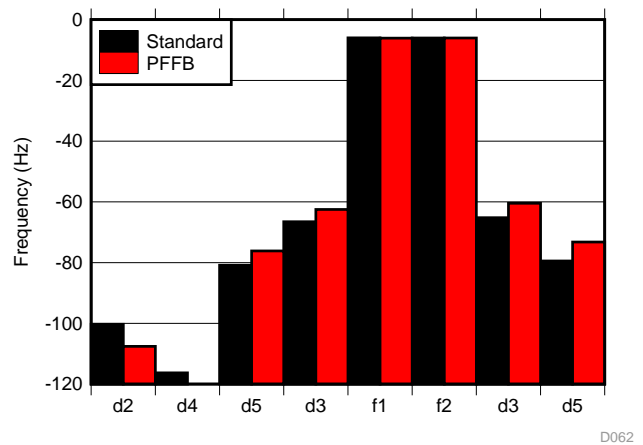

Figure 95. CCIF IMD Distortion Product Ratio at 10 W

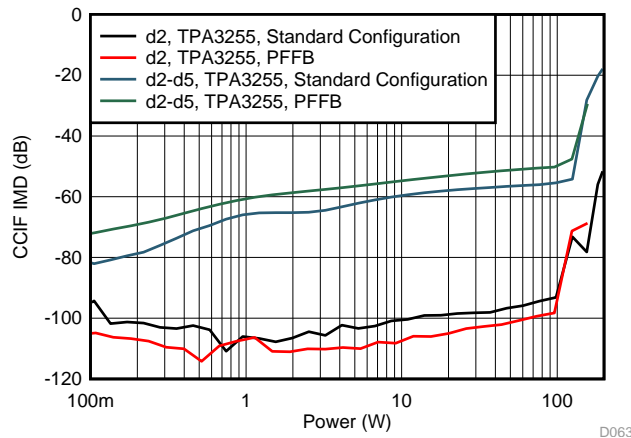

Figure 96. CCIF IMD vs Power

E.6 TPA3255 Stability Analysis

Table 54. TPA3255 – PFFB

Load (Ω)	Overshoot (%)	Phase Margin (degrees)
OL	78.4	8.8
4	16.3	51.8
8	35.0	35.0

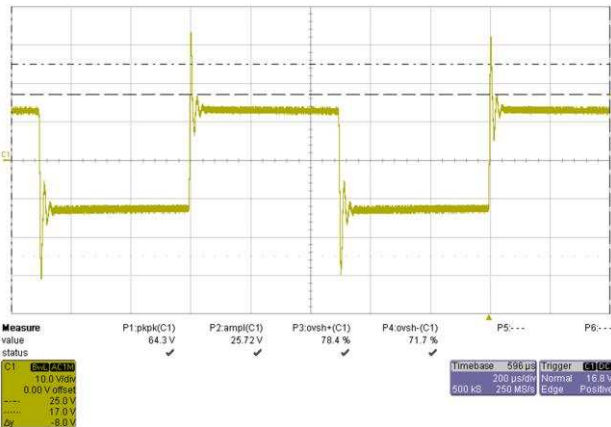

Figure 97. TPA3255 PFFB – Open-Load Response

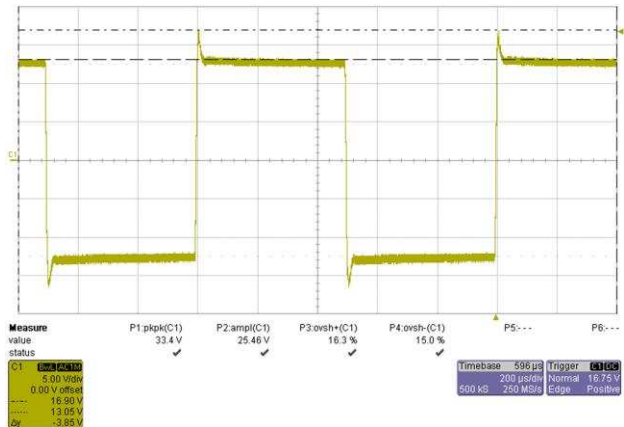

Figure 98. TPA3255 PFFB – 8- Ω Response

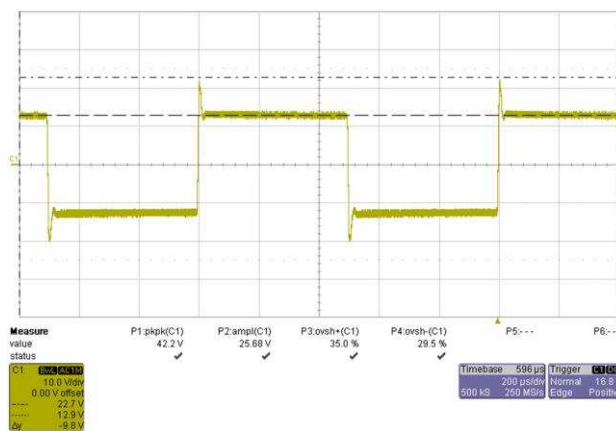

Figure 99. TPA3255 PFFB – 8- Ω Response

Revision History

NOTE: Page numbers for previous revisions may differ from page numbers in the current version.

Changes from Original (September 2017) to A Revision	Page
• Changed TPA3244 and TPA3245 column from "PVDD = 31.5" to "PVDD = 30 V" in Table 1 , Table 2 , Table 3 , Table 4 , and Table 5	4
• Changed TPA3244 column from "Fpwm = kHz" to "Fpwm = 450 kHz" in Table 1 , Table 2 , Table 3 , Table 4 , and Table 5	4
• Changed C_out values from μH to μF.....	4
• Changed TND+N to THD+N in <i>THD+N vs Power Inductor Comparison</i>	5
• Corrected <i>THD+N vs Power Inductor Comparison</i> legend	5
• Changed "with a PVDD = 31.5 V" to "with a PVDD = 30 V" in Section 7	7
• Switched "Standard EVM" and "PFFB" values in Table 6 , Table 7 , Table 8 , Table 9 , Table 10 , Table 11 , Table 16 , Table 17 , Table 18 , Table 19 , Table 20 , Table 21 , Table 24 , Table 25 , Table 26 , Table 27 , Table 28 , Table 29 , Table 32 , Table 33 , Table 34 , Table 35 , Table 36 , Table 37 , Table 40 , Table 41 , Table 42 , Table 43 , Table 44 , Table 45 , Table 48 , Table 49 , Table 50 , Table 51 , Table 52 , and Table 53	7

IMPORTANT NOTICE FOR TI DESIGN INFORMATION AND RESOURCES

Texas Instruments Incorporated ("TI") technical, application or other design advice, services or information, including, but not limited to, reference designs and materials relating to evaluation modules, (collectively, "TI Resources") are intended to assist designers who are developing applications that incorporate TI products; by downloading, accessing or using any particular TI Resource in any way, you (individually or, if you are acting on behalf of a company, your company) agree to use it solely for this purpose and subject to the terms of this Notice.

TI's provision of TI Resources does not expand or otherwise alter TI's applicable published warranties or warranty disclaimers for TI products, and no additional obligations or liabilities arise from TI providing such TI Resources. TI reserves the right to make corrections, enhancements, improvements and other changes to its TI Resources.

You understand and agree that you remain responsible for using your independent analysis, evaluation and judgment in designing your applications and that you have full and exclusive responsibility to assure the safety of your applications and compliance of your applications (and of all TI products used in or for your applications) with all applicable regulations, laws and other applicable requirements. You represent that, with respect to your applications, you have all the necessary expertise to create and implement safeguards that (1) anticipate dangerous consequences of failures, (2) monitor failures and their consequences, and (3) lessen the likelihood of failures that might cause harm and take appropriate actions. You agree that prior to using or distributing any applications that include TI products, you will thoroughly test such applications and the functionality of such TI products as used in such applications. TI has not conducted any testing other than that specifically described in the published documentation for a particular TI Resource.

You are authorized to use, copy and modify any individual TI Resource only in connection with the development of applications that include the TI product(s) identified in such TI Resource. NO OTHER LICENSE, EXPRESS OR IMPLIED, BY ESTOPPEL OR OTHERWISE TO ANY OTHER TI INTELLECTUAL PROPERTY RIGHT, AND NO LICENSE TO ANY TECHNOLOGY OR INTELLECTUAL PROPERTY RIGHT OF TI OR ANY THIRD PARTY IS GRANTED HEREIN, including but not limited to any patent right, copyright, mask work right, or other intellectual property right relating to any combination, machine, or process in which TI products or services are used. Information regarding or referencing third-party products or services does not constitute a license to use such products or services, or a warranty or endorsement thereof. Use of TI Resources may require a license from a third party under the patents or other intellectual property of the third party, or a license from TI under the patents or other intellectual property of TI.

TI RESOURCES ARE PROVIDED "AS IS" AND WITH ALL FAULTS. TI DISCLAIMS ALL OTHER WARRANTIES OR REPRESENTATIONS, EXPRESS OR IMPLIED, REGARDING TI RESOURCES OR USE THEREOF, INCLUDING BUT NOT LIMITED TO ACCURACY OR COMPLETENESS, TITLE, ANY EPIDEMIC FAILURE WARRANTY AND ANY IMPLIED WARRANTIES OF MERCHANTABILITY, FITNESS FOR A PARTICULAR PURPOSE, AND NON-INFRINGEMENT OF ANY THIRD PARTY INTELLECTUAL PROPERTY RIGHTS.

TI SHALL NOT BE LIABLE FOR AND SHALL NOT DEFEND OR INDEMNIFY YOU AGAINST ANY CLAIM, INCLUDING BUT NOT LIMITED TO ANY INFRINGEMENT CLAIM THAT RELATES TO OR IS BASED ON ANY COMBINATION OF PRODUCTS EVEN IF DESCRIBED IN TI RESOURCES OR OTHERWISE. IN NO EVENT SHALL TI BE LIABLE FOR ANY ACTUAL, DIRECT, SPECIAL, COLLATERAL, INDIRECT, PUNITIVE, INCIDENTAL, CONSEQUENTIAL OR EXEMPLARY DAMAGES IN CONNECTION WITH OR ARISING OUT OF TI RESOURCES OR USE THEREOF, AND REGARDLESS OF WHETHER TI HAS BEEN ADVISED OF THE POSSIBILITY OF SUCH DAMAGES.

You agree to fully indemnify TI and its representatives against any damages, costs, losses, and/or liabilities arising out of your non-compliance with the terms and provisions of this Notice.

This Notice applies to TI Resources. Additional terms apply to the use and purchase of certain types of materials, TI products and services. These include; without limitation, TI's standard terms for semiconductor products (<http://www.ti.com/sc/docs/stdterms.htm>), [evaluation modules](#), and [samples](http://www.ti.com/sc/docs/sampterm.htm) (<http://www.ti.com/sc/docs/sampterm.htm>).

Mailing Address: Texas Instruments, Post Office Box 655303, Dallas, Texas 75265
Copyright © 2018, Texas Instruments Incorporated