

Inductor Selection Guide for 2.1 MHz Class-D Amplifiers

Gregg Scott

Mid-Power Audio Amplifiers

ABSTRACT

All automotive Class-D audio amplifier designs require a filter on the output of the amplifier to remove the fundamental switching frequency. New technologies, like the 2.1-MHz high switching frequency used on TI's latest automotive Class-D audio amplifiers, drive significant changes in the inductor requirements for the LC filter. A traditional 400-kHz Class-D automotive audio amplifier typically uses a 10 μH , while the 2.1-MHz higher switching frequency amplifier design can take advantage of a much smaller and lighter-weight inductor in the range of 3.3- μH (assuming that each amplifier provides equivalent output power). The important parameters are discussed to understand their effects on determining the proper inductor needed for high frequency class-D amplifiers.

Contents

1	Inductor Parameters	2
2	Determine the Proper Inductance Value	2
3	Selection Guide	7
4	References	9

List of Figures

1	LC Filter for BD Mode (Half is Shown)	2
2	Frequency Response of a Type 2 Filter (3.3- μH Inductor, 1- μF Capacitor, 4- Ω Load)	3
3	Inductance vs DC Current	4
4	Temperature Rise vs DC Current	4
5	Core Material	5
6	Inductor THD FFT	5
7	THD vs Power	6
8	THD+N vs Output Power with 4- Ω load	7
9	THD+N vs Output Power with 2- Ω load	8

List of Tables

1	Inductor Specifications	7
---	-------------------------------	---

1 Inductor Parameters

1.1 Inductance

An inductor is a component that both stores the AC energy passing through it in its magnetic field, as well as resists change to the passing current level. The Inductance value influences the rate of change of current through the inductor.

1.2 DC Resistance (DCR)

This is the DC resistance of the internal conductor and is directly related to DC current losses. This is the largest contributor to efficiency loss in class-D amplifiers.

1.3 Saturation Current

The saturation current is the amount of current specified as a maximum or typical value flowing through the inductor which will induce a specified drop in inductance of the inductor. This is not the maximum current allowed to flow through the inductor. It is a single point on the L vs. I graph.

1.4 Temperature Rise Current

The temperature rise current is the amount of current (Max or Typical) flowing through the inductor which induces a specified increase in the temperature of the inductor. This is typically specified as a 40°C rise above ambient. This is not the maximum current allowed to flow through the inductor. It is a point on the Temp vs. I graph

1.5 L vs I Graph

Using the L vs I graph or Inductance (L) versus Current (I) graph is helpful in understanding how the inductor reacts with audio signals over the power range of the amplifier as well as in a current limit event.

2 Determine the Proper Inductance Value

There are several application notes already written on determining the proper inductance value for class-D amplifiers, such as, [SLOA119](#) and [SLAA701](#). Refer to these documents to determine the LC filter values.

The 2.1-MHz high switching frequency devices use BD modulation, resulting in the single-ended circuit shown in [Figure 1](#) (see [SLAA701](#) for derivation).

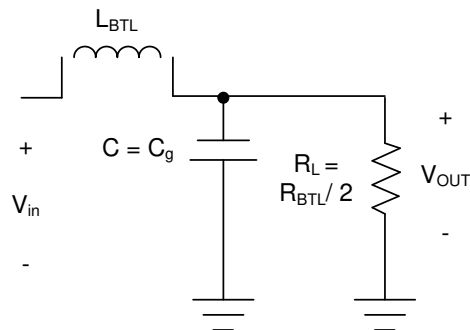

Figure 1. LC Filter for BD Mode (Half is Shown)

The 2.1-MHz switching frequency of these devices allow for a higher cutoff frequency to be used than with 500 kHz class-D amplifiers. This higher cutoff frequency requires a lower inductance value resulting in an inductor that can be physically smaller.

Using the calculations in the referenced application notes, the values for the LC filter are 3.3- μ H inductor and 1- μ F capacitor on each leg of the device. Assuming a 4- Ω load, this gives a cutoff frequency of 116 kHz. With a 2- Ω load this gives a cutoff frequency of 64 kHz. The capacitor value chosen is optimized for both 4- Ω and 2- Ω loads. This means that the response is slightly over-damped for a 2- Ω load and slightly under-damped for a 4- Ω load as illustrated in [Figure 2](#).

A minimum inductance value is provided in the data sheets. This is due to higher ripple currents with lower values of inductance which may interfere with the current protections. This value should not be violated under all operating conditions over current and temperature.

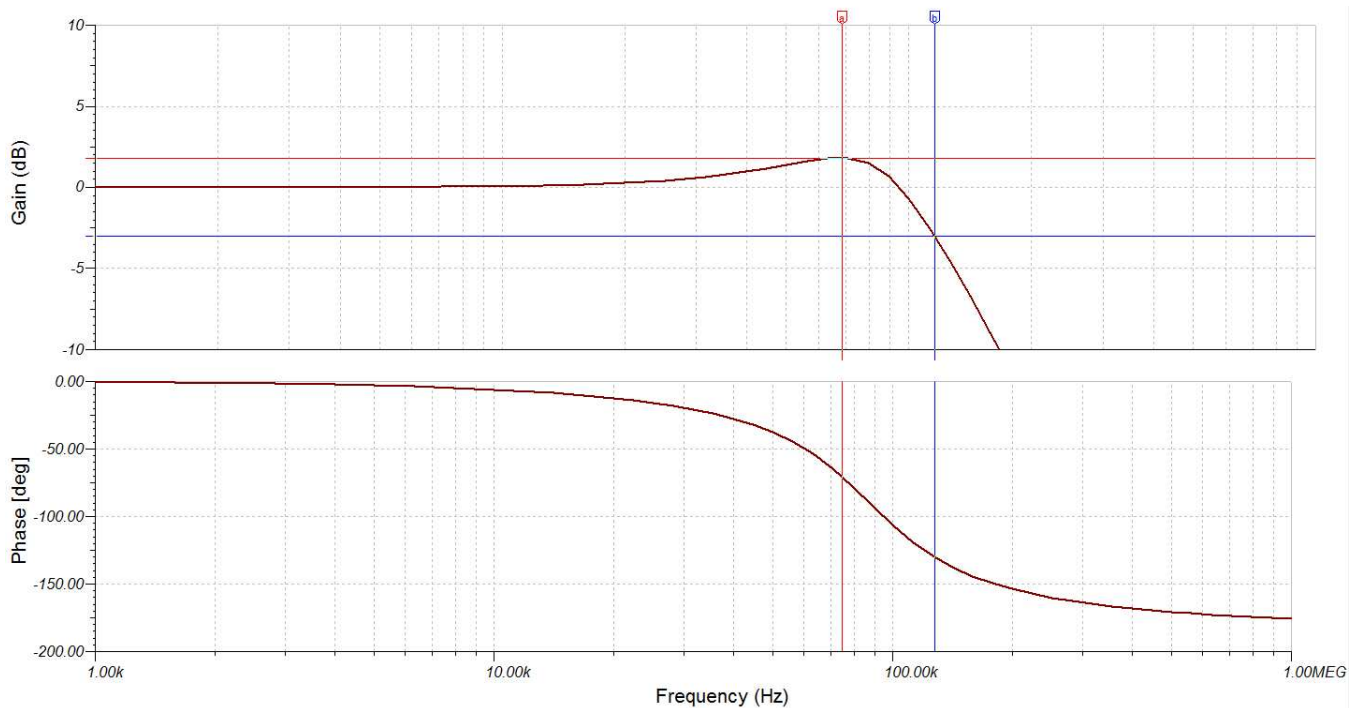

Figure 2. Frequency Response of a Type 2 Filter (3.3- μ H Inductor, 1- μ F Capacitor, 4- Ω Load)

2.1 Inductance vs. DC Current

The graph in [Figure 3](#) shows the relationship between inductance and DC current for a typical 3.3 μH low permeability inductor. The inductance starts falling off as current rises. Conversely, a high permeability switched mode power supply (SMPS) inductor holds the inductance as current increases and eventually drops off at saturation. A SMPS needs the inductance to be stable to provide regulation and stability of the system. For audio amplifiers, this is not the case and low permeability inductors provide higher saturation current for a smaller size inductor (this is explained further in the core material section of this app note). The inductance vs. DC current graph is important in inductor choice as the designer must ensure that the inductance does not go below the 2 μH minimum inductance at the highest expected current.

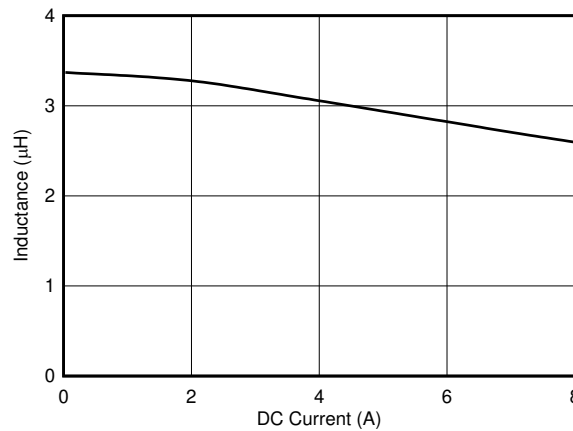

Figure 3. Inductance vs DC Current

2.2 Temp vs. I Graph

The temperature vs. I graph is shown in [Figure 4](#). The temperature rise in the inductor is primarily due to the copper losses in the magnet wire. The wire has a resistance at DC (DCR), and it also has a resistance at higher AC frequencies that increases due to skin effect (ACR). The wire in inductors for the 2.1 MHz high frequency class-D amplifiers have a small diameter so the ACR can be neglected. The current rating due to temperature should be decided by the system designer. The temperature rise has a long time constant, so the average current or average power should be used and is system dependent.

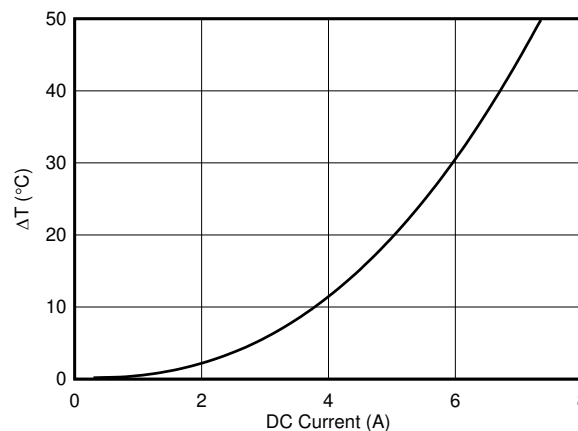

Figure 4. Temperature Rise vs DC Current

The DCR does play a role in the maximum output power that can be delivered to the speaker. In a BTL class-D amplifier, there are two inductors in series with the speaker that form a voltage divider. This reduces the signal level at the speaker terminals. The DCR needs to be chosen to allow for the required power level to be delivered to the speaker.

2.3 Core Material

The core material plays the crucial part in how the inductor behaves over the operating current and temperature ranges. It is important to understand the differences and tradeoffs with these materials. The materials can be separated into three types: low, medium, and high permeability (perm). A metal alloy material is classified as a low perm material whereas ferrites fall into medium and high perm.

The metal alloy materials have a low perm, where the inductance starts to drop with current but saturates at a high current. They are also very stable over temperature. Whereas ferrites tend to hold their inductance until they saturate typically at a lower current. Ferrites also are sensitive temperature. As temperature increases the saturation current decreases. Therefore, the filter design must take the worst case temperature into account.

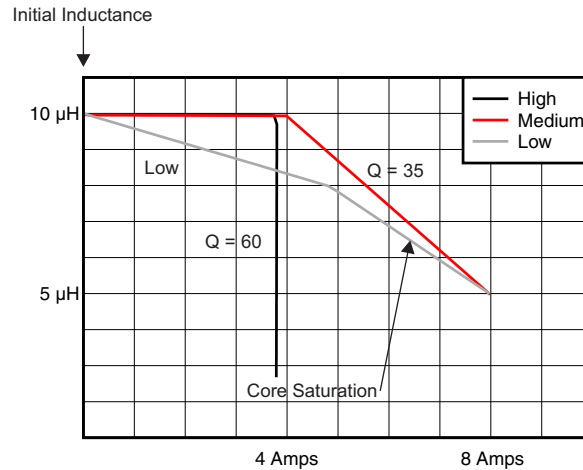

Figure 5. Core Material

A low permeability inductor results in a decreased B field in the inductor core and thus lower harmonics introduced by the inductor. The inductor harmonics are shown in Figure 6. Lower harmonics results in better THD and make low permeability inductors preferable for audio applications. Since low permeability inductors are preferred in this application, it is important to consider the decreasing inductance as current is increased. An inductor should be chosen such that the LC filter does not saturate to near zero inductance. Large current spikes causes the amplifier to prematurely trip the current limit or the over current shutdown protection.

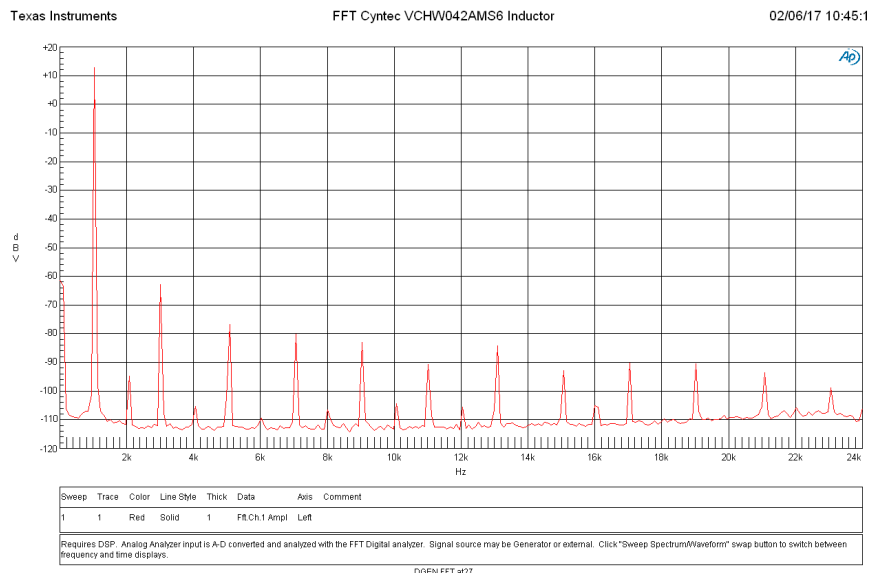

Figure 6. Inductor THD FFT

2.4 Linearity

The linearity of the inductor is not on most inductor data sheets. The linearity is determined by measuring the total harmonic distortion plus noise (THD+n) of the amplifier versus output power. The linearity of the inductor is due to the material that used in the core and the volume of the core material. See [Figure 7](#) for an explanation of the THD+n versus output power curve.

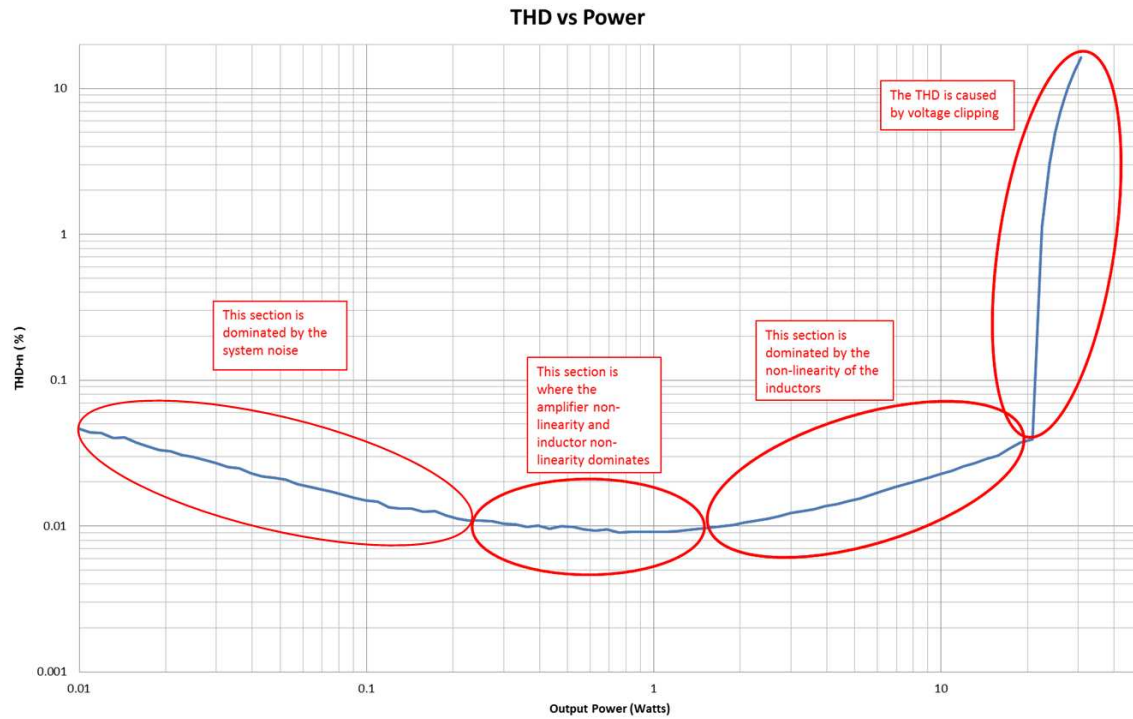

Figure 7. THD vs Power

3 Selection Guide

The selection guide has been created by collecting the data sheets and measuring the THD+n for the inductors. The ranking is determined by the goal of the design. The goals are separated for output power into a load, THD, and physical dimensions.

Table 1. Inductor Specifications

Part Number	Inductance	Dimensions L x W x H (mm)	L _{SAT} (A)	L _{TEMP} (A)	DCR (mΩ)
ABCO LPHM4020T-3R3M-R	3.3 μH	4.0 x 4.0 x 2.0	3.8	3.5	57.0
Cyntec VCHW042A MS6	3.3 μH	4.2 x 4 x 2.1	5.0	4.9	38.0
Cyntec VCMV052G-MN2	3.3 μH	5.45 x 5.25 x 2.8	5.3	5.5	33.0
Cyntec VCMT063T MN5	3.3 μH	7 x 6.6 x 2.8	7.5	7.5	22.5
Cyntec VAMV06077E-3R3MM2-79	3.3 μH x 2	6.9 x 7.6 x 7.3	13	5.7	16.0
Coilmaster CMI-CMMPFF322530QL-3R3M	3.3 μH	3.2 x 2.5 x 3	3.6	3.5	35.0
Coilmaster CMI-CMMP4030HL-3R3M	3.3 μH	4.4 x 4.4 x 3.0	7.5	4.6	42.0
Murata DFE322520FD-3R3M	3.3 μH	3.2 x 2.5 x 2	3.9	3.3	51.0
Murata DFEG0730D-3R3M	3.3 μH	7 x 6.6 x 3	7.1	6.7	24.0
Murata FDS0420-H-3R3M	3.3 μH	4.2 x 4.2 x 2	4.9	3.4	59.0
Sagami DBL8087H-3R3M-R1	3.3 μH x 2	8.0 x 8.0 x 9.0	3.9	7.2	18.0
Sunlord ASWPA6055S3R3MT1	3.3 μH	6.0 x 6.0 x 5.5	6.6	4.0	21.0
Sunlord ASWPA4035S3R3MT	3.3 μH	4.0 x 0 4.0 x 3.5	3.8	2.9	53.0
Sumida C2DEPIH80D90NP-3R3MC	3.3 μH x 2	8.0 x 8.0 x 9.0	9.0	6.2	10.7
Taiyo Yuden NRS5040T-3R3M	3.3 μH	4.9 x 4.9 x 4.0	4.0	3.3	27.0
Taiyo Yuden NRS8040T-3R6NJGV	3.6 μH	8.0 x 8.0 x 4.0	6.8	6.0	15.0
Würth 784 383 560 33	3.3 μH	4.0 x 4.0 x 2.0	5.5	3.6	39.9

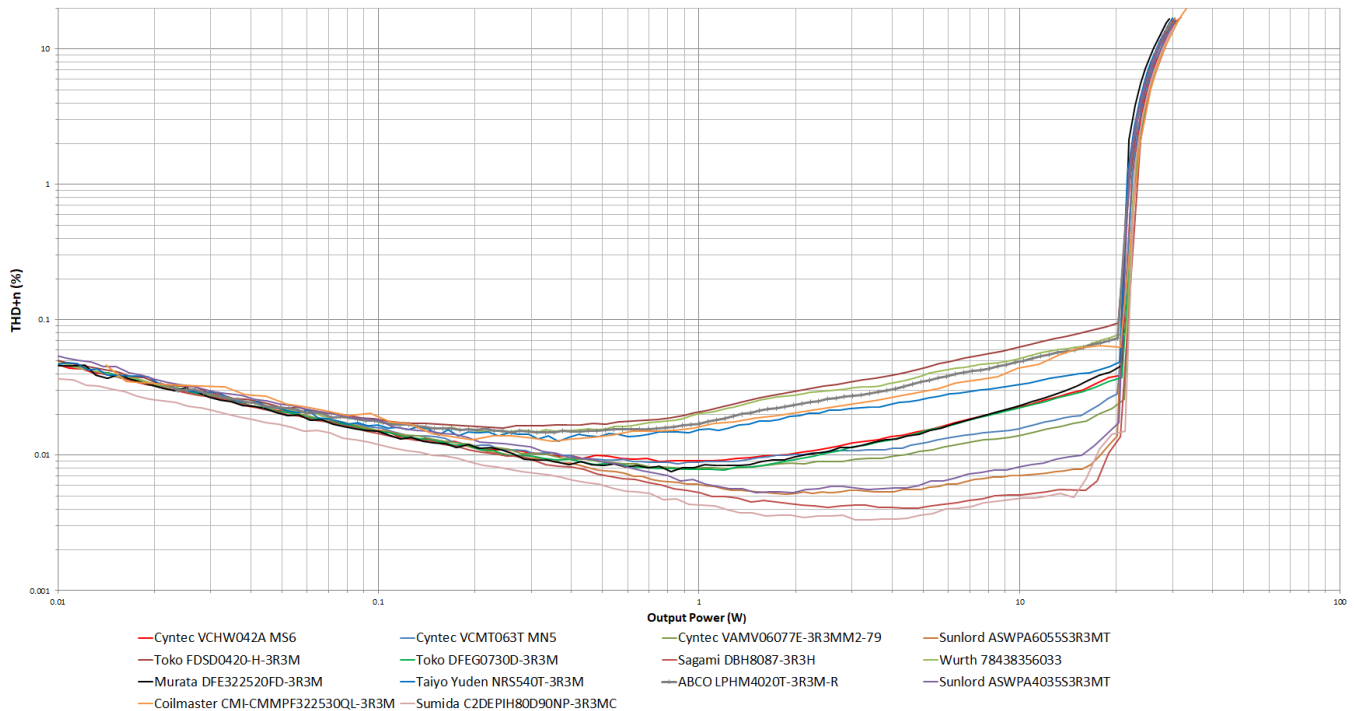

Figure 8. THD+N vs Output Power with 4-Ω load

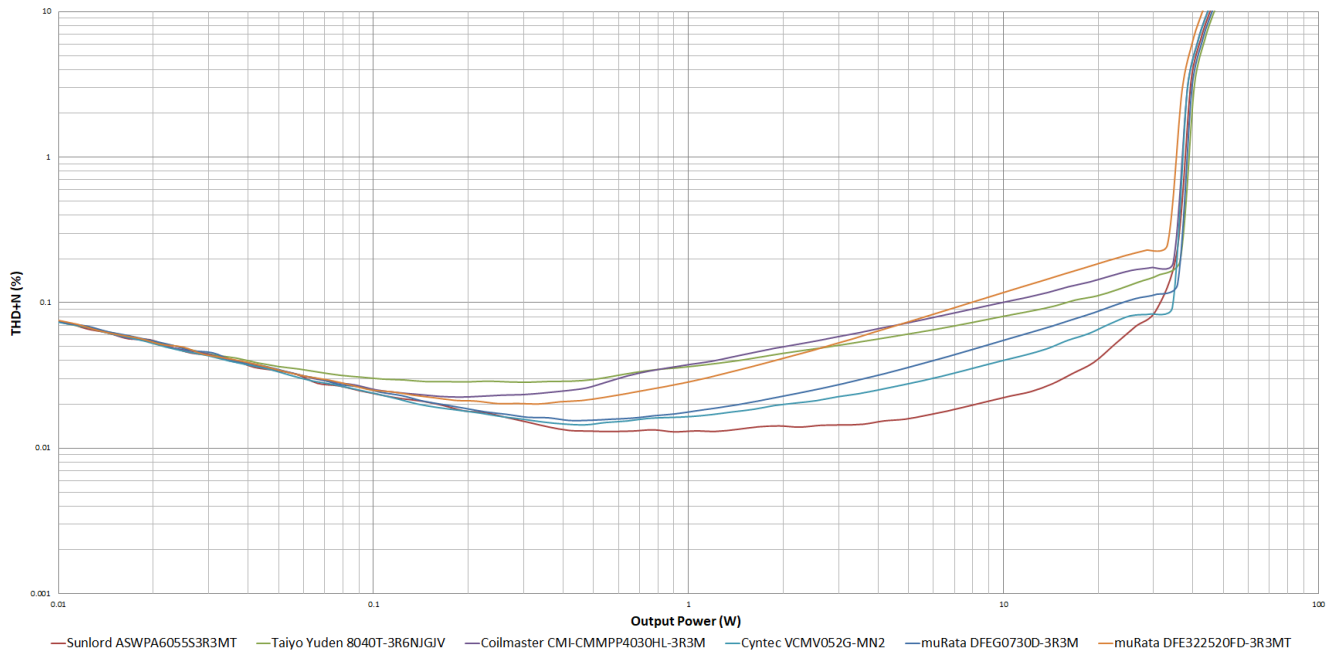

Figure 9. THD+N vs Output Power with 2-Ω load

3.1 Rank

Ranking is based on the customer specifications and the system needs. Testing has been provided to help in choosing or ranking inductors. The inductors are evaluated for their overall current handling capability, minimum inductance curves, and linearity to determine whether these inductors are recommended for driving 2 Ω loads and 4 Ω loads. A chart is created to compare the inductors that were tested. The THD vs Power graphs are created for 4 Ω and 2 Ω loads. The size and price of the inductors may need to be evaluated before making their final selection. Although the price of the inductors has not been part of this study, typically, the smaller the inductor the lower the cost. This may not hold true in all cases.

4 References

- Cyntec: <http://www.cyntec.com/productList.aspx?id=7>
 Murata: <http://www.murata.com/en-global/products/inductor>
 Sagami: <http://www.sagami-elec.co.jp/en/product/list.php?srctype=cat&cat=07&catk=03>
 Sunlord: <http://www.sunlordinc.com/>
 Taiyo Yuden: <http://www.t-yuden.com/ut/product/category/inductor/>
 Toko: <http://www.toko.co.jp/products/en/index2.html>
 Würth: http://www.we-online.com/web/en/all_electronic_components/Start_PB.php
 Sumida: <http://products.sumida.com/ProductsInfo/?lang=en>
 ABCO: <http://www.abco.co.kr>
 Coilmaster: http://www.coilmaster.com/index_eng.php

5 Trademarks

All trademarks are the property of their respective owners.

Revision History

NOTE: Page numbers for previous revisions may differ from page numbers in the current version.

Changes from Original (June 2017) to A Revision	Page
• Changed the document title To: <i>Inductor Selection Guide for 2.1 MHz Class-D Amplifiers</i>	1
• Changed the Abstract statement	1
• Changed Table 1	7
• Changed Figure 8	7
• Added Figure 9	8
• Changed the <i>Rank</i> section	9
• Changed the <i>References</i> section	9

IMPORTANT NOTICE AND DISCLAIMER

TI PROVIDES TECHNICAL AND RELIABILITY DATA (INCLUDING DATASHEETS), DESIGN RESOURCES (INCLUDING REFERENCE DESIGNS), APPLICATION OR OTHER DESIGN ADVICE, WEB TOOLS, SAFETY INFORMATION, AND OTHER RESOURCES "AS IS" AND WITH ALL FAULTS, AND DISCLAIMS ALL WARRANTIES, EXPRESS AND IMPLIED, INCLUDING WITHOUT LIMITATION ANY IMPLIED WARRANTIES OF MERCHANTABILITY, FITNESS FOR A PARTICULAR PURPOSE OR NON-INFRINGEMENT OF THIRD PARTY INTELLECTUAL PROPERTY RIGHTS.

These resources are intended for skilled developers designing with TI products. You are solely responsible for (1) selecting the appropriate TI products for your application, (2) designing, validating and testing your application, and (3) ensuring your application meets applicable standards, and any other safety, security, or other requirements. These resources are subject to change without notice. TI grants you permission to use these resources only for development of an application that uses the TI products described in the resource. Other reproduction and display of these resources is prohibited. No license is granted to any other TI intellectual property right or to any third party intellectual property right. TI disclaims responsibility for, and you will fully indemnify TI and its representatives against, any claims, damages, costs, losses, and liabilities arising out of your use of these resources.

TI's products are provided subject to TI's Terms of Sale (www.ti.com/legal/termsofsale.html) or other applicable terms available either on ti.com or provided in conjunction with such TI products. TI's provision of these resources does not expand or otherwise alter TI's applicable warranties or warranty disclaimers for TI products.

Mailing Address: Texas Instruments, Post Office Box 655303, Dallas, Texas 75265
Copyright © 2019, Texas Instruments Incorporated