

TPS2295x-Q1 5.7-V, 5-A, 14-mΩ On-Resistance, Automotive Load Switch

1 Features

- Qualified for automotive applications
- AEC-Q100 qualified:
 - Device temperature grade 1: -40°C to 125°C ambient operating temperature range
- Integrated single channel load switch
- Input voltage range: 0.7 V to 5.7 V
- R_{ON} resistance
 - $R_{\text{ON}} = 14\text{ m}\Omega$ at $V_{\text{IN}} = 5\text{ V}$ ($V_{\text{BIAS}} = 5\text{ V}$)
- 5-A maximum continuous switch current
- Adjustable Undervoltage Lockout Threshold (UVLO)
- Adjustable voltage supervisor with Power Good (PG) indicator
- Adjustable output slew rate control
- Enhanced quick output discharge remains active after power is removed (TPS22954-Q1 only)
 - $15\ \Omega$ (typ.) discharges $100\ \mu\text{F}$ within 10 ms
- Reverse current blocking when disabled (TPS22953-Q1 only)
- Automatic restart after supervisor fault detection when enabled
- Thermal shutdown
- Low quiescent current $\leq 50\ \mu\text{A}$
- SON 10-pin package with thermal pad
- ESD performance tested per JESD 22
 - 2-kV HBM and 750-V CDM

2 Applications

- [Infotainment and cluster head unit](#)
- [Automotive cluster display](#)
- [ADAS surround view system ECU](#)
- [Body control module and gateway](#)

3 Description

The TPS2295x-Q1 are small, single channel load switches with controlled turn-on. The devices contain an N-channel MOSFET that can operate over an input voltage range of 0.7 V to 5.7 V and can support a maximum continuous current of 5 A.

The integrated adjustable Undervoltage Lockout (UVLO) and adjustable Power Good (PG) threshold provides voltage monitoring as well as robust power sequencing. The adjustable rise-time control of the device greatly reduces inrush current for a wide variety of bulk load capacitances, thereby reducing or eliminating power supply droop. The switch is independently controlled by an on and off input (EN), which is capable of interfacing directly with low-voltage control signals. A $15\text{-}\Omega$ on-chip load is integrated into the device for a quick discharge of the output when the switch is disabled. The enhanced Quick Output Discharge (QOD) remains active for a short time after power is removed from the device to finish discharging the output.

The TPS2295x-Q1 are available in small, space-saving 10-SON packages with integrated thermal pad, allowing for high power dissipation. The device is characterized for operation over the free-air temperature range of -40°C to $+125^{\circ}\text{C}$.

Device Information⁽¹⁾

PART NUMBER	PACKAGE (PIN)	BODY SIZE (NOM)
TPS2295x-Q1	WSON (10)	2.00 mm × 3.00 mm

(1) For all available packages, see the orderable addendum at the end of the data sheet.

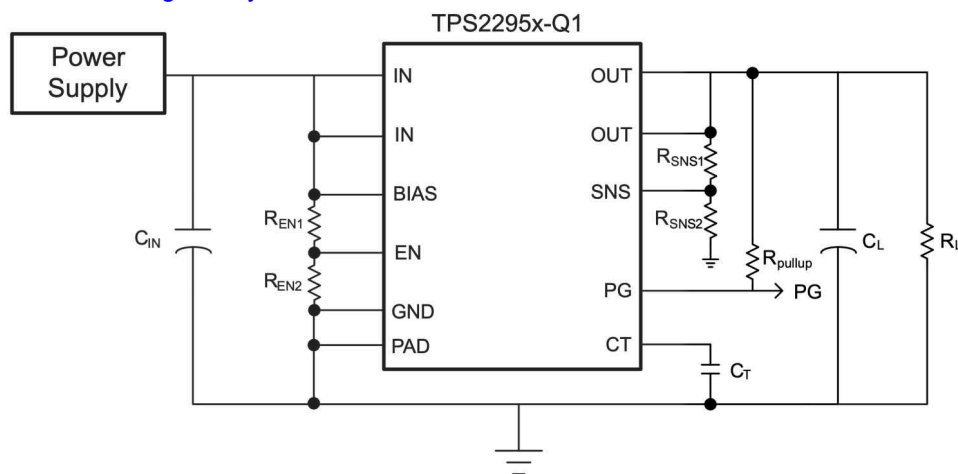

Simplified Schematic



Table of Contents

1 Features	1	9.1 Overview.....	21
2 Applications	1	9.2 Functional Block Diagram.....	21
3 Description	1	9.3 Feature Description.....	22
4 Revision History	2	9.4 Device Functional Modes.....	28
5 Device Comparison Table	3	10 Application and Implementation	29
6 Pin Configuration and Functions	3	10.1 Application Information.....	29
7 Specifications	4	10.2 Typical Application.....	34
7.1 Absolute Maximum Ratings.....	4	11 Power Supply Recommendations	37
7.2 ESD Ratings	4	12 Layout	37
Recommended Operating Conditions.....	4	12.1 Layout Guidelines.....	37
7.3 Thermal Information.....	4	12.2 Layout Example.....	37
7.4 Electrical Characteristics.....	5	13 Device and Documentation Support	38
7.5 Electrical Characteristics – VBIAS = 5 V.....	5	13.1 Documentation Support.....	38
7.6 Electrical Characteristics – VBIAS = 3.3 V.....	6	13.2 Receiving Notification of Documentation Updates..	38
7.7 Electrical Characteristics – VBIAS = 2.5 V.....	7	13.3 Support Resources.....	38
7.8 Switching Characteristics – CT = 1000 pF.....	9	13.4 Trademarks.....	38
7.9 Switching Characteristics – CT = 0 pF.....	10	13.5 Electrostatic Discharge Caution.....	38
7.10 Typical DC Characteristics.....	11	13.6 Glossary.....	38
7.11 Typical Switching Characteristics.....	14	14 Mechanical, Packaging, and Orderable Information	38
8 Parameter Measurement Information	20		
9 Detailed Description	21		

4 Revision History

NOTE: Page numbers for previous revisions may differ from page numbers in the current version.

Changes from Revision * (November 2021) to Revision A (June 2022)	Page
• Changed status from "Advance Information" to "Production Data".....	1

5 Device Comparison Table

Device	Quick Output Discharge	Reverse Current Blocking	Package (Pin)	Body Size	Pin Pitch
TPS22954-Q1	Yes	No	DQC (10)	2.00 mm × 3.00 mm	0.5 mm
TPS22953-Q1	No	Yes	DQC (10)	2.00 mm × 3.00 mm	0.5 mm

6 Pin Configuration and Functions

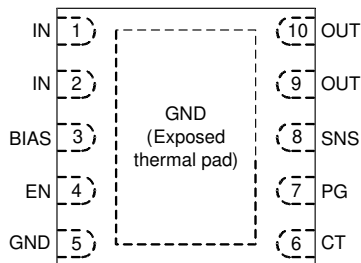

Figure 6-1. DQC/DSQ Package 10-Pin WSON Top View

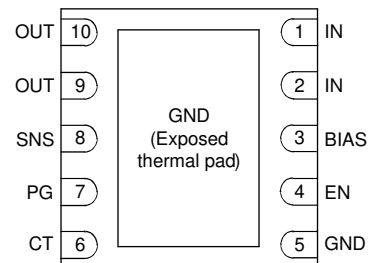

Figure 6-2. DQC/DSQ Package 10-Pin WSON Bottom View

Table 6-1. Pin Functions

PIN ⁽¹⁾		I/O	DESCRIPTION
NO.	NAME		
1	IN	I	Switch input. Bypass this input with a ceramic capacitor to GND.
2			
3	BIAS	I	Bias pin and power supply to the device
4	EN	I	Active high switch to enable and disable the output. Also acts as the input UVLO pin. Use external resistor divider to adjust the UVLO level. Do not leave floating.
5	GND	—	Device ground
6	CT	O	V_{OUT} slew rate control. Place ceramic cap from CT to GND to change the V_{OUT} slew rate of the device and limit the inrush current. Rate the CT Capacitor to 25 V or higher.
7	PG	O	Power Good. This pin is open drain which pulls low when the voltage on EN or SNS is below their respective VIL levels.
8	SNS	I	Sense pin. Use external resistor divider to adjust the power good level. Do not leave floating.
9	OUT	O	Switch output
10			
—	Thermal Pad	—	Exposed thermal pad. Tie to GND.

(1) Pinout applies to all package versions.

7 Specifications

7.1 Absolute Maximum Ratings

Over operating free-air temperature range (unless otherwise noted)⁽¹⁾

		MIN	MAX	UNIT
V _{IN}	Input voltage	-0.3	6	V
V _{BIAS}	Bias voltage	-0.3	6	V
V _{OUT}	Output voltage	-0.3	6	V
V _{EN} , V _{SNS} , V _{PG}	EN, SNS, and PG voltage	-0.3	6	V
I _{MAX}	Maximum continuous switch current, T _A = 70°C		5	A
I _{PLS}	Maximum pulsed switch current, pulse < 300-μs, 2% duty cycle		7	A
T _J	Maximum junction temperature	Internally Limited		
T _{stg}	Storage temperature	-65	150	°C

- (1) Operation outside the Absolute Maximum Ratings may cause permanent device damage. Absolute Maximum Ratings do not imply functional operation of the device at these or any other conditions beyond those listed under Recommended Operating Conditions. If used outside the Recommended Operating Conditions but within the Absolute Maximum Ratings, the device may not be fully functional, and this may affect device reliability, functionality, performance, and shorten the device lifetime.

7.2 ESD Ratings

			VALUE	UNIT
V _(ESD)	Electrostatic discharge	Human body model (HBM), per AEC Q100-002 ⁽¹⁾ HBM ESD classification level 2	±2000	V
		Charged device model (CDM), per AEC Q100-011 CDM ESD classification level C5	±750	

- (1) AEC Q100-002 indicates that HBM stressing shall be in accordance with the ANSI/ESDA/JEDEC JS-001 specification.

Recommended Operating Conditions

over operating free-air temperature range (unless otherwise noted)

		MIN	MAX	UNIT
V _{IN}	Input voltage	0.7	V _{BIAS}	V
V _{BIAS}	Bias voltage	2.5	5.7	V
V _{OUT}	Output voltage	0.9	5.7	V
V _{EN} , V _{SNS} , V _{PG}	EN, SNS, and PG voltage	0	5.7	V
T _A	Operating free-air temperature	-40	125	°C
T _J	Operating junction temperature	-40	150	°C

7.3 Thermal Information

THERMAL METRIC ⁽¹⁾		TPS2295x-Q1	UNIT
		DQC (WSON)	
		10 PINS	
R _{θJA}	Junction-to-ambient thermal resistance	65.2	°C/W
R _{θJC(top)}	Junction-to-case (top) thermal resistance	73.9	°C/W
R _{θJB}	Junction-to-board thermal resistance	25.5	°C/W
ψ _{JT}	Junction-to-top characterization parameter	2	°C/W
ψ _{JB}	Junction-to-board characterization parameter	25.4	°C/W

- (1) For more information about traditional and new thermal metrics, see the [Semiconductor and IC Package Thermal Metrics](#) application report.

7.4 Electrical Characteristics

Unless otherwise noted, the specification in the following table applies over the operating ambient temperature $-40\text{ }^{\circ}\text{C} \leq T_A \leq +125\text{ }^{\circ}\text{C}$ and the recommended VBIAS voltage range of 2.5 V to 5.7 V. Typical values are for $T_A = 25\text{ }^{\circ}\text{C}$.

PARAMETER		TEST CONDITIONS	T_A	MIN	TYP	MAX	UNIT
V_{EN}	V_{IH} , Rising threshold	$V_{IN} = 0.7\text{ V to }V_{BIAS}$	$-40\text{ }^{\circ}\text{C to }+125\text{ }^{\circ}\text{C}$	650	700	750	mV
	V_{IL} , Falling threshold	$V_{IN} = 0.7\text{ V to }V_{BIAS}$	$-40\text{ }^{\circ}\text{C to }+125\text{ }^{\circ}\text{C}$	560	600	640	mV
V_{SNS}	V_{IH} , Rising threshold	$V_{IN} = 0.7\text{ V to }V_{BIAS}$	$-40\text{ }^{\circ}\text{C to }+125\text{ }^{\circ}\text{C}$	465	515	565	mV
	V_{IL} , Falling threshold	$V_{IN} = 0.7\text{ V to }V_{BIAS}$	$-40\text{ }^{\circ}\text{C to }+125\text{ }^{\circ}\text{C}$	410	455	500	mV
t_{BLANK}	Blanking time for EN and SNS	EN or SNS rising	$-40\text{ }^{\circ}\text{C to }+125\text{ }^{\circ}\text{C}$		100		μs
$t_{DEGLITCH}$	Deglintch time for EN and SNS	EN or SNS falling	$-40\text{ }^{\circ}\text{C to }+125\text{ }^{\circ}\text{C}$		5		μs
t_{DIS}	Output discharge time (TPS22954 only)	$C_L = 100\mu\text{F}$	$-40\text{ }^{\circ}\text{C to }+125\text{ }^{\circ}\text{C}$			10	ms
$t_{RESTART}$	Output restart time	SNS falling	$-40\text{ }^{\circ}\text{C to }+125\text{ }^{\circ}\text{C}$		2		ms
t_{RCB}	Response time for reverse current blocking (TPS22953 only)	$V_{OUT} = V_{BIAS}$ EN falling	$-40\text{ }^{\circ}\text{C to }+125\text{ }^{\circ}\text{C}$		10		μs
T_{SD}	Thermal shutdown	Junction temperature rising	-	130	150	170	$^{\circ}\text{C}$
T_{SDHYS}	Thermal shutdown hysteresis	Junction temperature falling	-		20		$^{\circ}\text{C}$
$I_{RCB,IN}$	Input reverse blocking current (TPS22953 only)	$V_{OUT} = 5\text{ V}, V_{IN} = V_{EN} = 0\text{ V},$ $V_{BIAS} = 0\text{ V to }5.7\text{ V}$	$25\text{ }^{\circ}\text{C}$		0.01	2	m Ω
			$-40\text{ }^{\circ}\text{C to }+85\text{ }^{\circ}\text{C}$			5	m Ω
			$-40\text{ }^{\circ}\text{C to }+125\text{ }^{\circ}\text{C}$			11	m Ω

7.5 Electrical Characteristics – VBIAS = 5 V

Unless otherwise noted, the specification in the following table applies over the operating ambient temperature $-40\text{ }^{\circ}\text{C} \leq T_A \leq +125\text{ }^{\circ}\text{C}$ and $V_{BIAS} = 5\text{ V}$. Typical values are for $T_A = 25\text{ }^{\circ}\text{C}$.

PARAMETER		TEST CONDITIONS	T_A	MIN	TYP	MAX	UNIT	
$I_{Q,BIAS}$	BIAS quiescent current	$I_{OUT} = 0, V_{IN} = 0.7\text{ V to }V_{BIAS}, V_{EN} = 5\text{ V}$	$-40\text{ }^{\circ}\text{C to }+85\text{ }^{\circ}\text{C}$		34	45	μA	
			$-40\text{ }^{\circ}\text{C to }+125\text{ }^{\circ}\text{C}$			50		
$I_{SD,BIAS}$	BIAS shutdown current	$V_{OUT} = 0\text{ V}, V_{IN} = 0.7\text{ V to }V_{BIAS}, V_{EN} = 0\text{ V to }V_{IL}$	$-40\text{ }^{\circ}\text{C to }+85\text{ }^{\circ}\text{C}$		5	7	μA	
			$-40\text{ }^{\circ}\text{C to }+125\text{ }^{\circ}\text{C}$			8		
$I_{SD,IN}$	Input shutdown current	$V_{EN} = 0\text{ V to }V_{IL}, V_{OUT} = 0\text{ V}$	$V_{IN} = 5\text{ V}$	$-40\text{ }^{\circ}\text{C to }+85\text{ }^{\circ}\text{C}$		0.02	4	μA
				$-40\text{ }^{\circ}\text{C to }+125\text{ }^{\circ}\text{C}$			13	
			$V_{IN} = 3.3\text{ V}$	$-40\text{ }^{\circ}\text{C to }+85\text{ }^{\circ}\text{C}$		0.01	3	
				$-40\text{ }^{\circ}\text{C to }+125\text{ }^{\circ}\text{C}$			10	
			$V_{IN} = 1.8\text{ V}$	$-40\text{ }^{\circ}\text{C to }+85\text{ }^{\circ}\text{C}$		0.01	3	
				$-40\text{ }^{\circ}\text{C to }+125\text{ }^{\circ}\text{C}$			10	
			$V_{IN} = 1.2\text{ V}$	$-40\text{ }^{\circ}\text{C to }+85\text{ }^{\circ}\text{C}$		0.01	2	
				$-40\text{ }^{\circ}\text{C to }+125\text{ }^{\circ}\text{C}$			8	
$V_{IN} = 0.7\text{ V}$	$-40\text{ }^{\circ}\text{C to }+85\text{ }^{\circ}\text{C}$		0.01	2				
	$-40\text{ }^{\circ}\text{C to }+125\text{ }^{\circ}\text{C}$			8				
I_{EN}	EN pin leakage current	$V_{EN} = 0\text{ V to }5.7\text{ V}$	$-40\text{ }^{\circ}\text{C to }+125\text{ }^{\circ}\text{C}$			0.1	μA	
I_{SNS}	SNS pin leakage current	$V_{SNS} \leq V_{BIAS}$	$-40\text{ }^{\circ}\text{C to }+125\text{ }^{\circ}\text{C}$			0.1	μA	

7.5 Electrical Characteristics – VBIAS = 5 V (continued)

Unless otherwise noted, the specification in the following table applies over the operating ambient temperature $-40\text{ }^{\circ}\text{C} \leq T_A \leq +125\text{ }^{\circ}\text{C}$ and $V_{BIAS} = 5\text{ V}$. Typical values are for $T_A = 25\text{ }^{\circ}\text{C}$.

PARAMETER		TEST CONDITIONS		T_A	MIN	TYP	MAX	UNIT
R_{ON}	ON-resistance	$I_{OUT} = -200\text{ mA}$	$V_{IN} = 5\text{ V}$	25°C		14	20	mΩ
				-40°C to +85°C			23	
				-40°C to +125°C			24	
			$V_{IN} = 3.3\text{ V}$	25°C		14	20	
				-40°C to +85°C			23	
				-40°C to +125°C			24	
			$V_{IN} = 1.8\text{ V}$	25°C		14	20	
				-40°C to +85°C			23	
				-40°C to +125°C			24	
			$V_{IN} = 1.5\text{ V}$	25°C		14	20	
				-40°C to +85°C			23	
				-40°C to +125°C			24	
			$V_{IN} = 1.2\text{ V}$	25°C		14	20	
				-40°C to +85°C			23	
-40°C to +125°C				24				
$V_{IN} = 0.7\text{ V}$	25°C		14	20				
	-40°C to +85°C			23				
	-40°C to +125°C			24				
R_{PD}	Output pull down resistance (TPS22954 only)	$V_{IN} = V_{OUT} = V_{BIAS}, V_{EN} = 0\text{ V}$	25°C		15	28	Ω	
			-40°C to +125°C			30	Ω	

7.6 Electrical Characteristics – VBIAS = 3.3 V

Unless otherwise noted, the specification in the following table applies over the operating ambient temperature $-40\text{ }^{\circ}\text{C} \leq T_A \leq +125\text{ }^{\circ}\text{C}$ and $V_{BIAS} = 3.3\text{ V}$. Typical values are for $T_A = 25\text{ }^{\circ}\text{C}$.

PARAMETER		TEST CONDITIONS		T_A	MIN	TYP	MAX	UNIT
$I_{Q, BIAS}$	BIAS quiescent current	$I_{OUT} = 0, V_{IN} = 0.7\text{ V to } V_{BIAS}, V_{EN} = 3.3\text{ V}$	-40°C to +85°C		19	35	μA	
			-40°C to +125°C			37		
$I_{SD, BIAS}$	BIAS shutdown current	$V_{OUT} = 0\text{ V}, V_{IN} = 0.7\text{ V to } V_{BIAS}, V_{EN} = 0\text{ V to } V_{IL}$	-40°C to +85°C		4	6	μA	
			-40°C to +125°C			7		
$I_{SD, IN}$	Input shutdown current	$V_{EN} = 0\text{ V to } V_{IL}, V_{OUT} = 0\text{ V}$	$V_{IN} = 3.3\text{ V}$	-40°C to +85°C		0.01	3	μA
				-40°C to +125°C			10	
			$V_{IN} = 1.8\text{ V}$	-40°C to +85°C		0.01	3	
				-40°C to +125°C			10	
			$V_{IN} = 1.2\text{ V}$	-40°C to +85°C		0.01	2	
				-40°C to +125°C			8	
			$V_{IN} = 0.7\text{ V}$	-40°C to +85°C		0.01	2	
				-40°C to +125°C			8	
I_{EN}	EN pin leakage current	$V_{EN} = 0\text{ V to } 5.7\text{ V}$	-40°C to +125°C			0.1	μA	
I_{SNS}	SNS pin leakage current	$V_{SNS} \leq V_{BIAS}$	-40°C to +125°C			0.1	μA	

7.6 Electrical Characteristics – VBIAS = 3.3 V (continued)

Unless otherwise noted, the specification in the following table applies over the operating ambient temperature $-40\text{ }^{\circ}\text{C} \leq T_A \leq +125\text{ }^{\circ}\text{C}$ and $V_{BIAS} = 3.3\text{ V}$. Typical values are for $T_A = 25\text{ }^{\circ}\text{C}$.

PARAMETER		TEST CONDITIONS		T_A	MIN	TYP	MAX	UNIT
R_{ON}	ON-resistance	$I_{OUT} = -200\text{ mA}$	$V_{IN} = 3.3\text{ V}$	25°C		15	21	mΩ
				-40°C to +85°C			24	
				-40°C to +125°C			25	
			$V_{IN} = 1.8\text{ V}$	25°C		14	20	
				-40°C to +85°C			23	
				-40°C to +125°C			24	
			$V_{IN} = 1.5\text{ V}$	25°C		14	20	
				-40°C to +85°C			23	
				-40°C to +125°C			24	
			$V_{IN} = 1.2\text{ V}$	25°C		14	20	
				-40°C to +85°C			23	
				-40°C to +125°C			24	
$V_{IN} = 0.7\text{ V}$	25°C		14	20				
	-40°C to +85°C			23				
	-40°C to +125°C			24				
R_{PD}	Output pull down resistance (TPS22954 only)	$V_{IN} = V_{OUT} = V_{BIAS}, V_{EN} = 0\text{ V}$	25°C		13	28	Ω	
			-40°C to +125°C			30	Ω	

7.7 Electrical Characteristics – VBIAS = 2.5 V

Unless otherwise noted, the specification in the following table applies over the operating ambient temperature $-40\text{ }^{\circ}\text{C} \leq T_A \leq +125\text{ }^{\circ}\text{C}$ and $V_{BIAS} = 2.5\text{ V}$. Typical values are for $T_A = 25\text{ }^{\circ}\text{C}$.

PARAMETER		TEST CONDITIONS		T_A	MIN	TYP	MAX	UNIT
$I_{Q, BIAS}$	BIAS quiescent current	$I_{OUT} = 0, V_{IN} = 0.7\text{ V to } V_{BIAS}, V_{EN} = 2.5\text{ V}$	-40°C to +85°C		16	25	μA	
			-40°C to +125°C			27		
$I_{SD, BIAS}$	BIAS shutdown current	$V_{OUT} = 0\text{ V}, V_{IN} = 0.7\text{ V to } V_{BIAS}, V_{EN} = 0\text{ V to } V_{IL}$	-40°C to +85°C		4	5	μA	
			-40°C to +125°C			6		
$I_{SD, IN}$	Input shutdown current	$V_{EN} = 0\text{ V to } V_{IL}, V_{OUT} = 0\text{ V}$	$V_{IN} = 2.5\text{ V}$	-40°C to +85°C		0.01	3	μA
				-40°C to +125°C			10	
			$V_{IN} = 1.8\text{ V}$	-40°C to +85°C		0.01	3	
				-40°C to +125°C			10	
			$V_{IN} = 1.2\text{ V}$	-40°C to +85°C		0.01	2	
				-40°C to +125°C			8	
			$V_{IN} = 0.7\text{ V}$	-40°C to +85°C		0.01	2	
				-40°C to +125°C			8	
I_{EN}	EN pin leakage current	$V_{EN} = 0\text{ V to } 5.7\text{ V}$	-40°C to +125°C			0.1	μA	
I_{SNS}	SNS pin leakage current	$V_{SNS} \leq V_{BIAS}$	-40°C to +125°C			0.1	μA	

7.7 Electrical Characteristics – VBIAS = 2.5 V (continued)

Unless otherwise noted, the specification in the following table applies over the operating ambient temperature $-40\text{ }^{\circ}\text{C} \leq T_A \leq +125\text{ }^{\circ}\text{C}$ and $V_{BIAS} = 2.5\text{ V}$. Typical values are for $T_A = 25\text{ }^{\circ}\text{C}$.

PARAMETER		TEST CONDITIONS		T _A	MIN	TYP	MAX	UNIT
R _{ON}	ON-resistance	I _{OUT} = -200 mA	V _{IN} = 2.5 V	25°C		16	23	mΩ
				-40°C to +85°C			26	
				-40°C to +125°C			27	
			V _{IN} = 1.8 V	25°C		15	22	
				-40°C to +85°C			25	
				-40°C to +125°C			26	
			V _{IN} = 1.5 V	25°C		15	22	
				-40°C to +85°C			25	
				-40°C to +125°C			26	
			V _{IN} = 1.2 V	25°C		15	22	
				-40°C to +85°C			24	
				-40°C to +125°C			25	
V _{IN} = 0.7 V	25°C		14	21				
	-40°C to +85°C			24				
	-40°C to +125°C			25				
R _{PD}	Output pull down resistance (TPS22954 only)	V _{IN} = V _{OUT} = V _{BIAS} , V _{EN} = 0 V	25°C		12	28	Ω	
			-40°C to +125°C			30	Ω	

7.8 Switching Characteristics – CT = 1000 pF

All typical values are at 25°C unless otherwise noted

PARAMETER		TEST CONDITIONS	MIN	TYP	MAX	UNIT
V_{IN} = 5 V, V_{EN} = V_{BIAS} = 2.5 V, T_A = 25°C						
t _{ON}	Turn-On time	R _L = 10 Ω, C _L = 0.1 μF, C _T = 1000 pF		1265		μs
t _{OFF}	Turn-Off time	R _L = 10 Ω, C _L = 0.1 μF, C _T = 1000 pF		6		μs
t _R	V _{OUT} Rise time	R _L = 10 Ω, C _L = 0.1 μF, C _T = 1000 pF		1492		μs
t _F	V _{OUT} Fall time	R _L = 10 Ω, C _L = 0.1 μF, C _T = 1000 pF		2.2		μs
t _D	Delay time	R _L = 10 Ω, C _L = 0.1 μF, C _T = 1000 pF		519		μs
V_{IN} = 2.5 V, V_{EN} = V_{BIAS} = 5 V, T_A = 25°C						
t _{ON}	Turn-On time	R _L = 10 Ω, C _L = 0.1 μF, C _T = 1000 pF		813		μs
t _{OFF}	Turn-Off time	R _L = 10 Ω, C _L = 0.1 μF, C _T = 1000 pF		6.1		μs
t _R	V _{OUT} Rise time	R _L = 10 Ω, C _L = 0.1 μF, C _T = 1000 pF		765		μs
t _F	V _{OUT} Fall time	R _L = 10 Ω, C _L = 0.1 μF, C _T = 1000 pF		2.2		μs
t _D	Delay time	R _L = 10 Ω, C _L = 0.1 μF, C _T = 1000 pF		430		μs
V_{IN} = 0.7 V, V_{EN} = 5 V, V_{BIAS} = 5 V, T_A = 25°C						
t _{ON}	Turn-On time	R _L = 10 Ω, C _L = 0.1 μF, C _T = 1000 pF		476		μs
t _{OFF}	Turn-Off time	R _L = 10 Ω, C _L = 0.1 μF, C _T = 1000 pF		6.2		μs
t _R	V _{OUT} Rise time	R _L = 10 Ω, C _L = 0.1 μF, C _T = 1000 pF		245		μs
t _F	V _{OUT} Fall time	R _L = 10 Ω, C _L = 0.1 μF, C _T = 1000 pF		2.1		μs
t _D	Delay time	R _L = 10 Ω, C _L = 0.1 μF, C _T = 1000 pF		353		μs
V_{IN} = 2.5 V, V_{EN} = 5 V, V_{BIAS} = 2.5 V, T_A = 25°C						
t _{ON}	Turn-On time	R _L = 10 Ω, C _L = 0.1 μF, C _T = 1000 pF		813		μs
t _{OFF}	Turn-Off time	R _L = 10 Ω, C _L = 0.1 μF, C _T = 1000 pF		4.9		μs
t _R	V _{OUT} Rise time	R _L = 10 Ω, C _L = 0.1 μF, C _T = 1000 pF		765		μs
t _F	V _{OUT} Fall time	R _L = 10 Ω, C _L = 0.1 μF, C _T = 1000 pF		2.2		μs
t _D	Delay time	R _L = 10 Ω, C _L = 0.1 μF, C _T = 1000 pF		430		μs
V_{IN} = 0.7 V, V_{EN} = 5 V, V_{BIAS} = 2.5 V, T_A = 25°C						
t _{ON}	Turn-On time	R _L = 10 Ω, C _L = 0.1 μF, C _T = 1000 pF		476		μs
t _{OFF}	Turn-Off time	R _L = 10 Ω, C _L = 0.1 μF, C _T = 1000 pF		6.1		μs
t _R	V _{OUT} Rise time	R _L = 10 Ω, C _L = 0.1 μF, C _T = 1000 pF		245		μs
t _F	V _{OUT} Fall time	R _L = 10 Ω, C _L = 0.1 μF, C _T = 1000 pF		2.1		μs
t _D	Delay time	R _L = 10 Ω, C _L = 0.1 μF, C _T = 1000 pF		353		μs

7.9 Switching Characteristics – CT = 0 pF

All typical values are at 25°C unless otherwise noted

PARAMETER		TEST CONDITIONS	MIN	TYP	MAX	UNIT
V_{IN} = 5 V, V_{EN} = V_{BIAS} = 2.5 V, T_A = 25°C						
t _{ON}	Turn-On time	R _L = 10 Ω, C _L = 0.1 μF, C _T = 0 pF		235		μs
t _{OFF}	Turn-Off time	R _L = 10 Ω, C _L = 0.1 μF, C _T = 0 pF		6		μs
t _R	V _{OUT} Rise time	R _L = 10 Ω, C _L = 0.1 μF, C _T = 0 pF		140		μs
t _F	V _{OUT} Fall time	R _L = 10 Ω, C _L = 0.1 μF, C _T = 0 pF		2.2		μs
t _D	Delay time	R _L = 10 Ω, C _L = 0.1 μF, C _T = 0 pF		165		μs
V_{IN} = 2.5 V, V_{EN} = V_{BIAS} = 5 V, T_A = 25°C						
t _{ON}	Turn-On time	R _L = 10 Ω, C _L = 0.1 μF, C _T = 0 pF		200		μs
t _{OFF}	Turn-Off time	R _L = 10 Ω, C _L = 0.1 μF, C _T = 0 pF		6		μs
t _R	V _{OUT} Rise time	R _L = 10 Ω, C _L = 0.1 μF, C _T = 0 pF		79		μs
t _F	V _{OUT} Fall time	R _L = 10 Ω, C _L = 0.1 μF, C _T = 0 pF		2.1		μs
t _D	Delay time	R _L = 10 Ω, C _L = 0.1 μF, C _T = 0 pF		160		μs
V_{IN} = 0.7 V, V_{EN} = 5 V, V_{BIAS} = 5 V, T_A = 25°C						
t _{ON}	Turn-On time	R _L = 10 Ω, C _L = 0.1 μF, C _T = 0 pF		170		μs
t _{OFF}	Turn-Off time	R _L = 10 Ω, C _L = 0.1 μF, C _T = 0 pF		6		μs
t _R	V _{OUT} Rise time	R _L = 10 Ω, C _L = 0.1 μF, C _T = 0 pF		32		μs
t _F	V _{OUT} Fall time	R _L = 10 Ω, C _L = 0.1 μF, C _T = 0 pF		2		μs
t _D	Delay time	R _L = 10 Ω, C _L = 0.1 μF, C _T = 0 pF		154		μs
V_{IN} = 2.5 V, V_{EN} = 5 V, V_{BIAS} = 2.5 V, T_A = 25°C						
t _{ON}	Turn-On time	R _L = 10 Ω, C _L = 0.1 μF, C _T = 0 pF		200		μs
t _{OFF}	Turn-Off time	R _L = 10 Ω, C _L = 0.1 μF, C _T = 0 pF		6		μs
t _R	V _{OUT} Rise time	R _L = 10 Ω, C _L = 0.1 μF, C _T = 0 pF		79		μs
t _F	V _{OUT} Fall time	R _L = 10 Ω, C _L = 0.1 μF, C _T = 0 pF		2.1		μs
t _D	Delay time	R _L = 10 Ω, C _L = 0.1 μF, C _T = 0 pF		160		μs
V_{IN} = 0.7 V, V_{EN} = 5 V, V_{BIAS} = 2.5 V, T_A = 25°C						
t _{ON}	Turn-On time	R _L = 10 Ω, C _L = 0.1 μF, C _T = 0 pF		170		μs
t _{OFF}	Turn-Off time	R _L = 10 Ω, C _L = 0.1 μF, C _T = 0 pF		6		μs
t _R	V _{OUT} Rise time	R _L = 10 Ω, C _L = 0.1 μF, C _T = 0 pF		32		μs
t _F	V _{OUT} Fall time	R _L = 10 Ω, C _L = 0.1 μF, C _T = 0 pF		2		μs
t _D	Delay time	R _L = 10 Ω, C _L = 0.1 μF, C _T = 0 pF		154		μs

7.10 Typical DC Characteristics

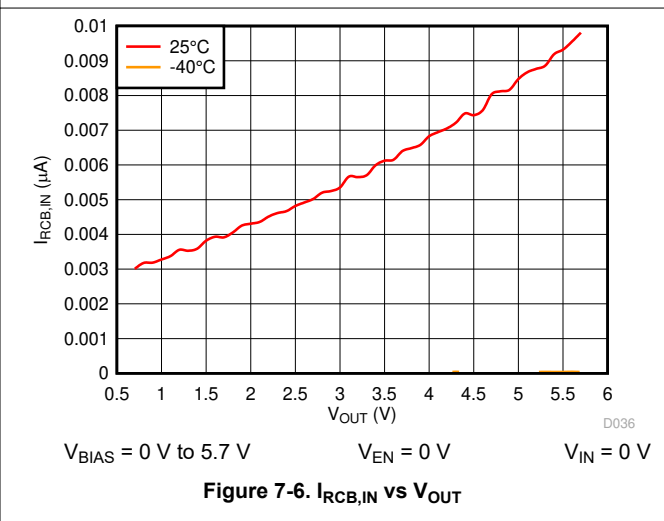
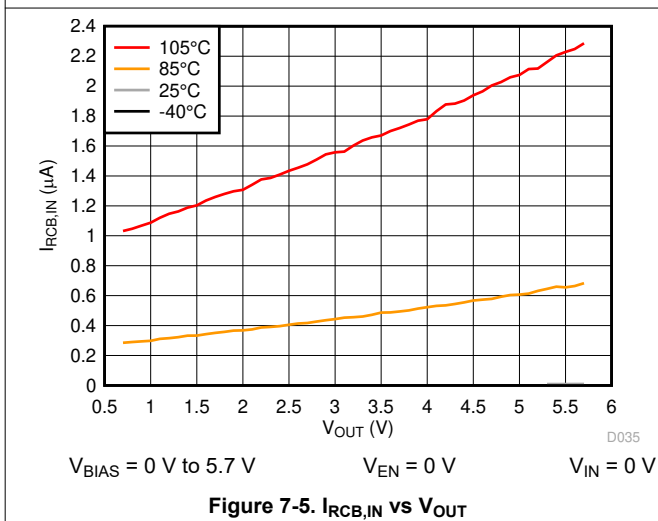
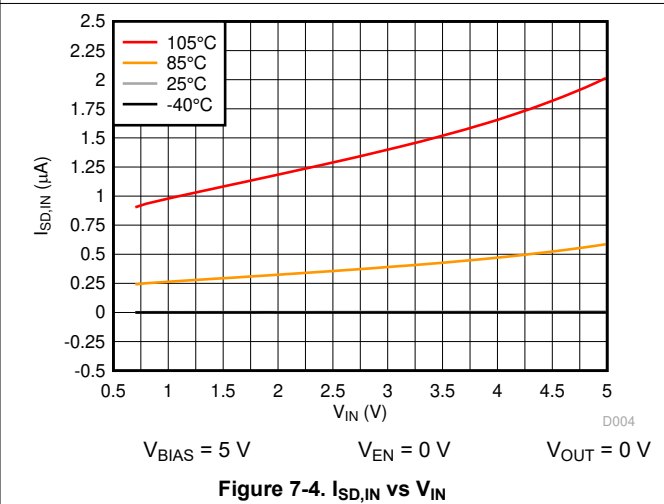
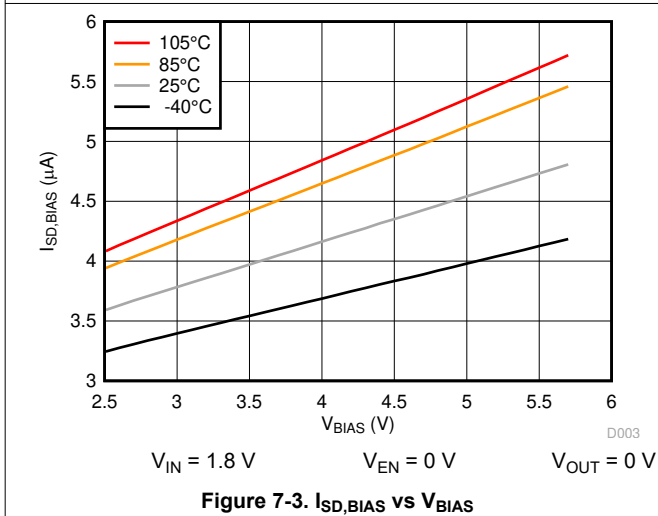
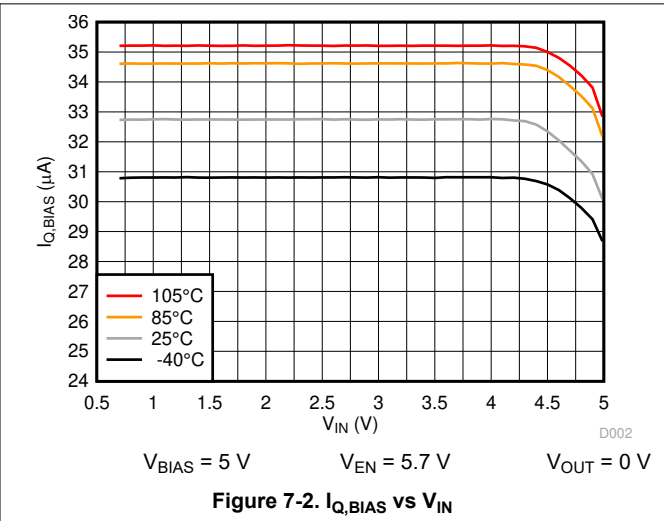
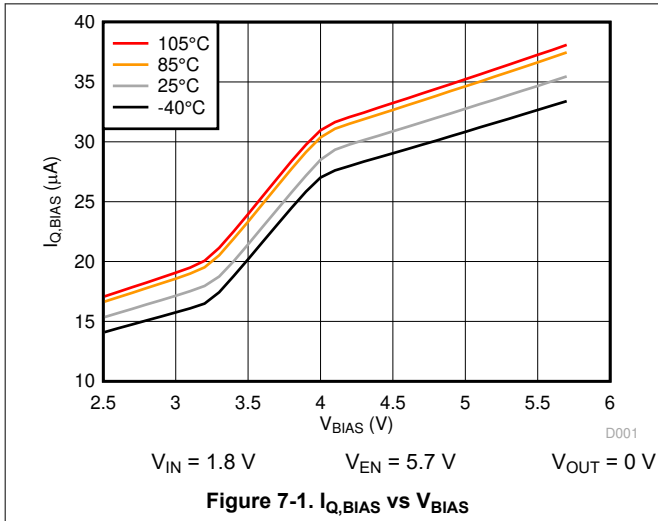

7.10 Typical DC Characteristics (continued)

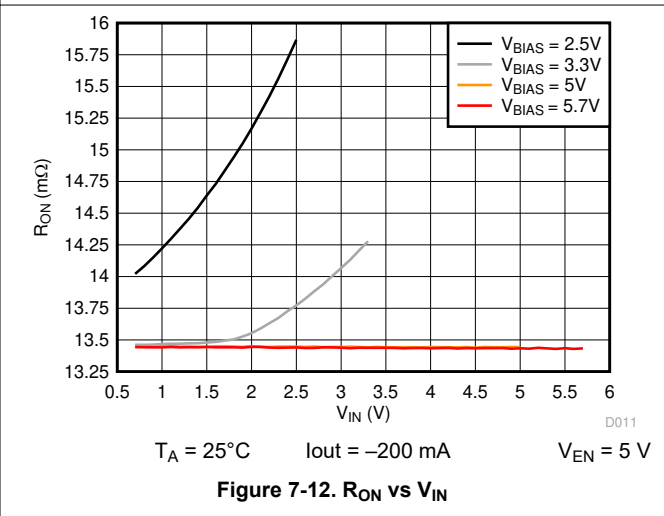
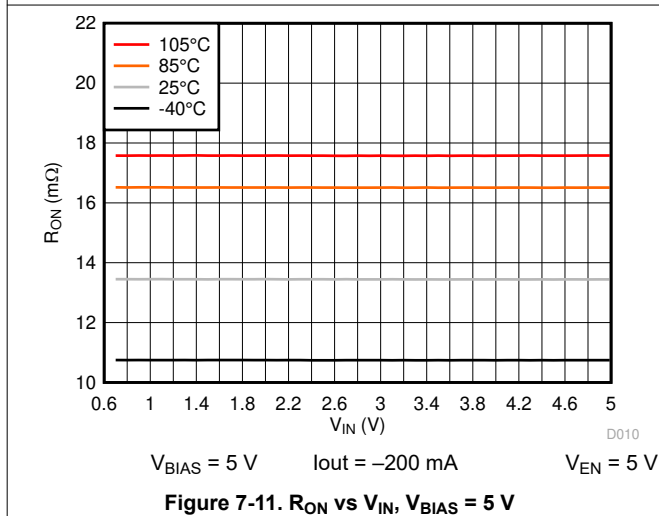
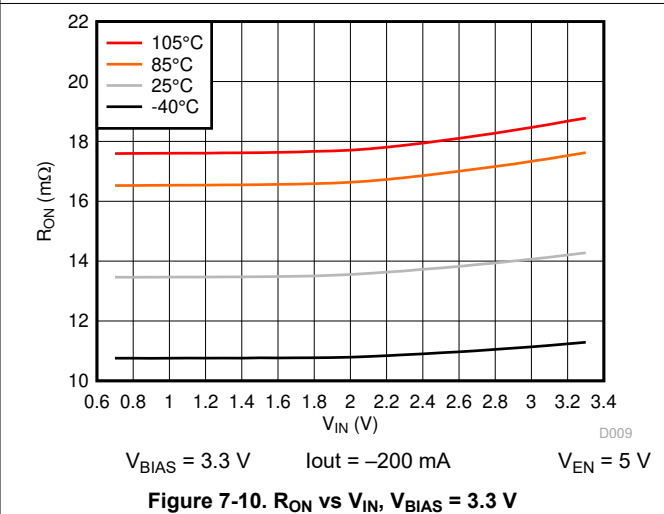
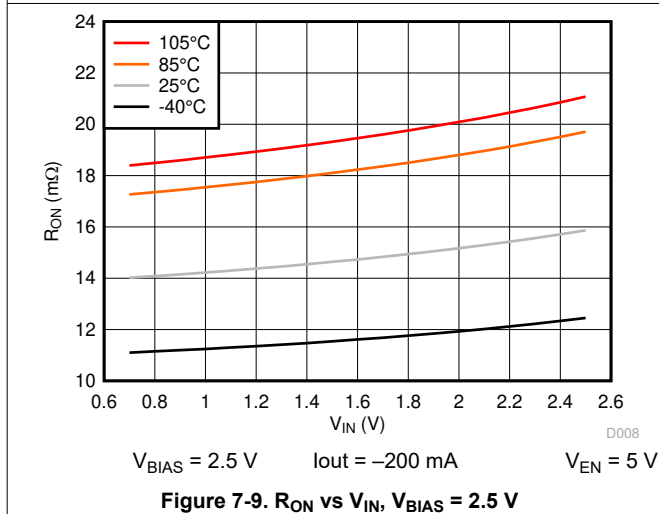
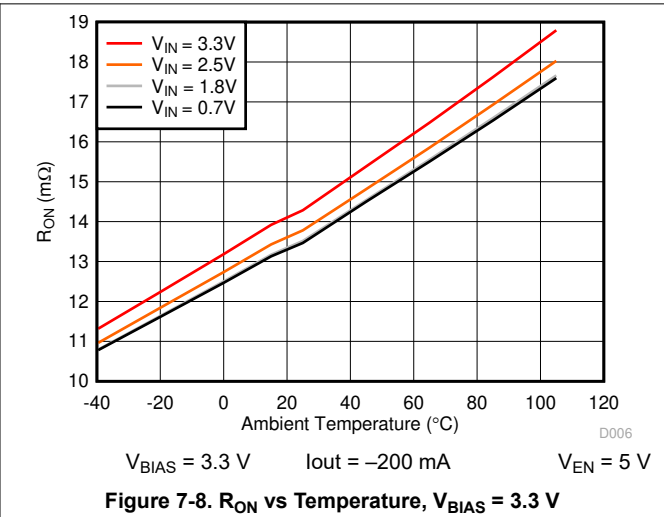
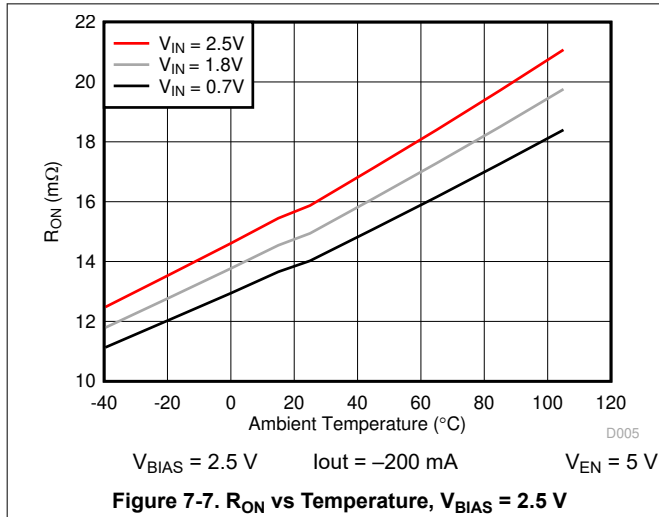

7.10 Typical DC Characteristics (continued)

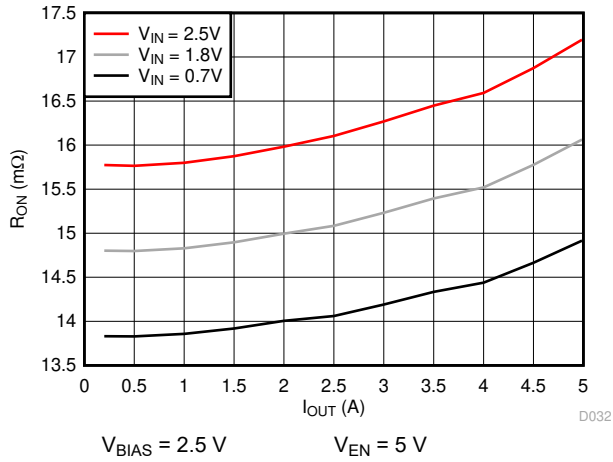

Figure 7-13. R_{ON} vs I_{OUT} , $V_{BIAS} = 2.5$ V

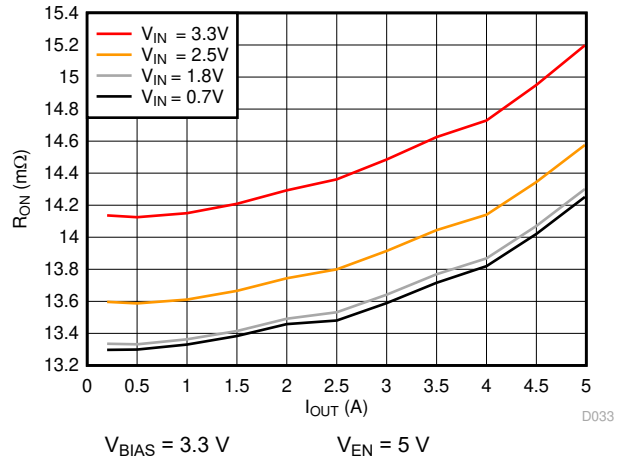

Figure 7-14. R_{ON} vs I_{OUT} , $V_{BIAS} = 3.3$ V

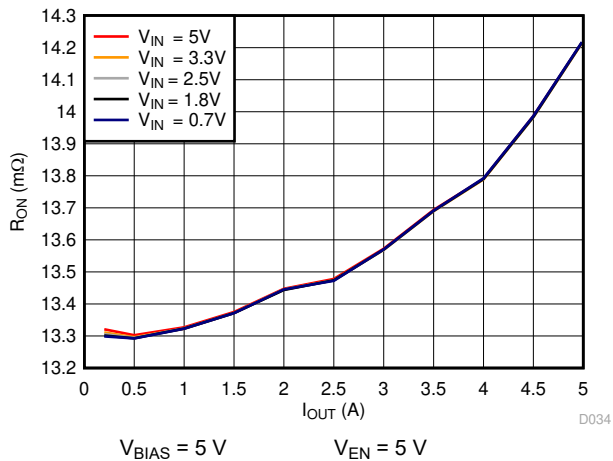

Figure 7-15. R_{ON} vs I_{OUT} , $V_{BIAS} = 5$ V

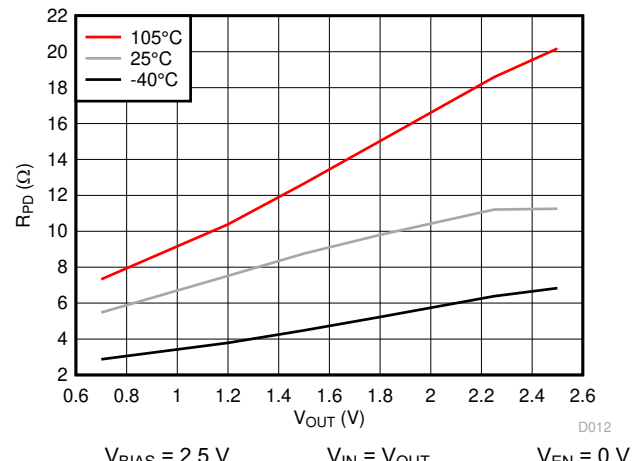

Figure 7-16. R_{PD} vs V_{OUT} , $V_{BIAS} = 2.5$ V

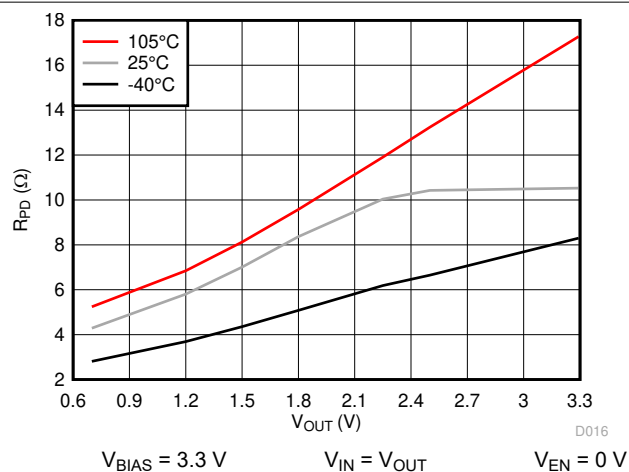

Figure 7-17. R_{PD} vs V_{OUT} , $V_{BIAS} = 3.3$ V

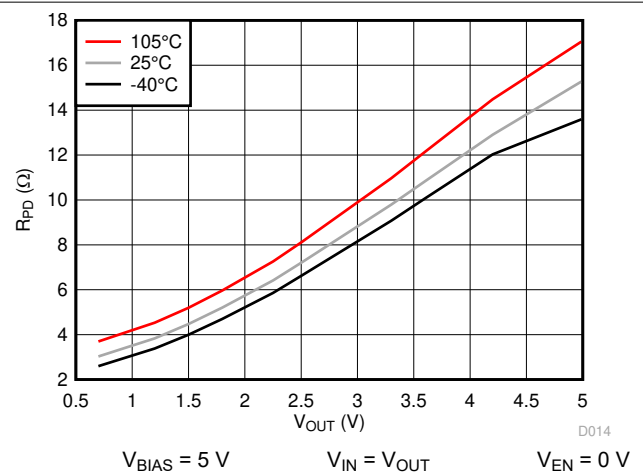
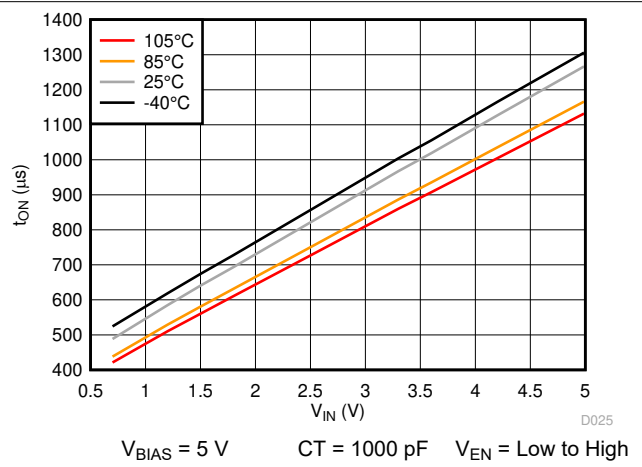
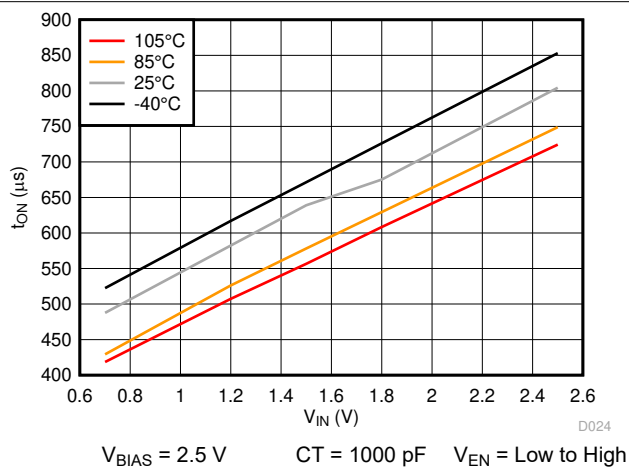
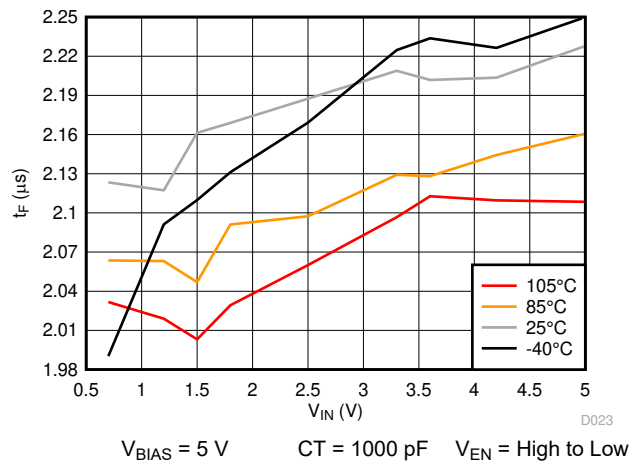
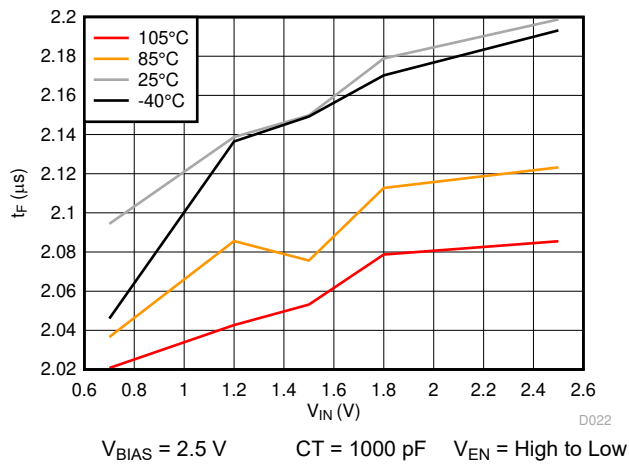
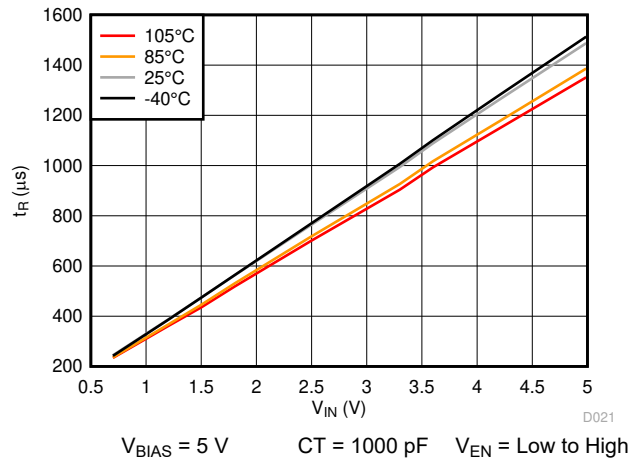
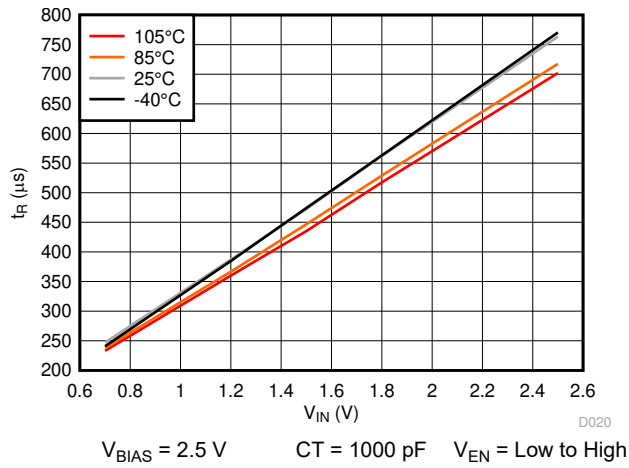
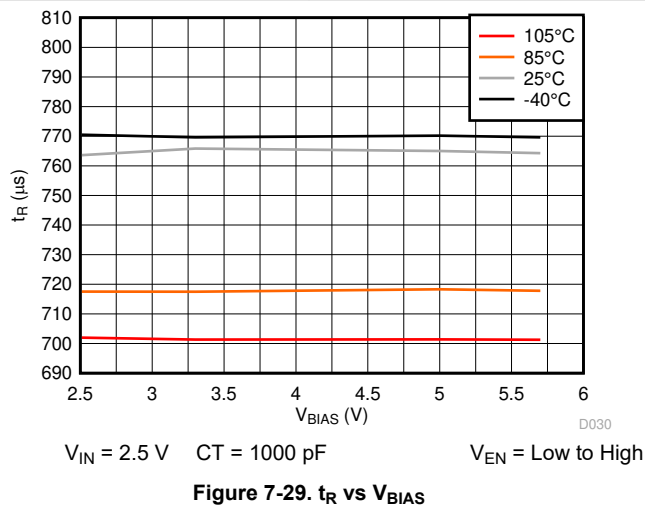
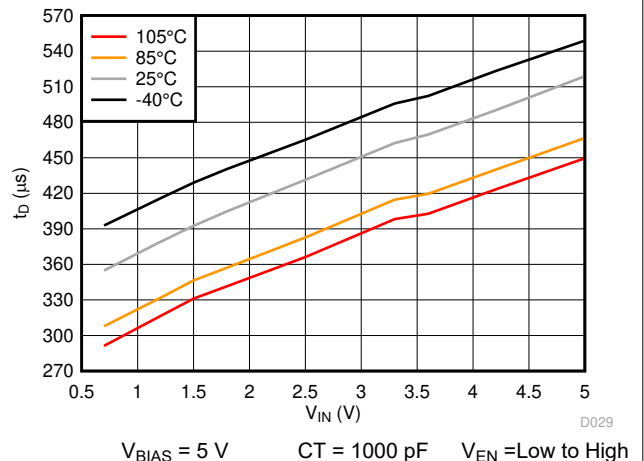
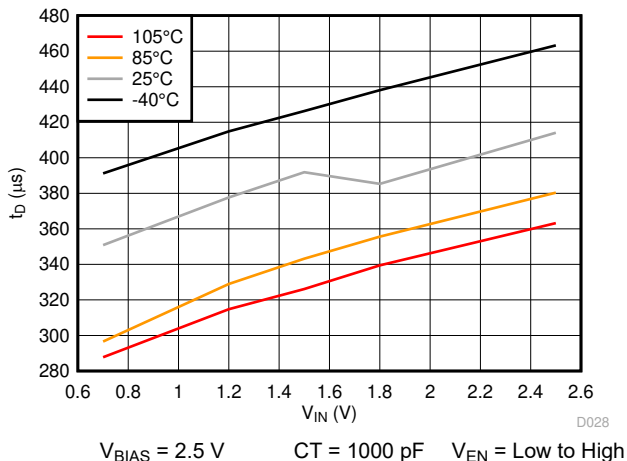
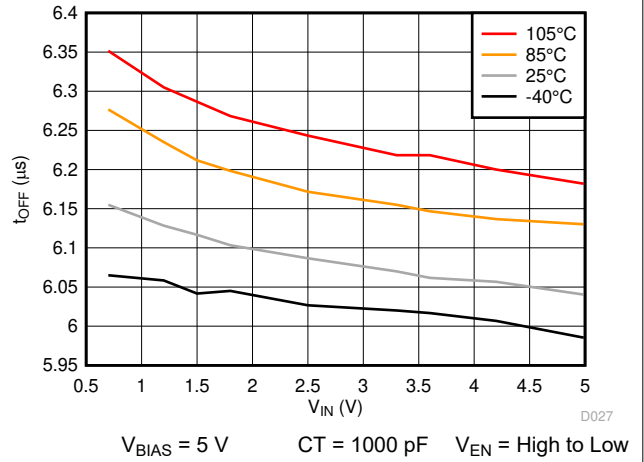
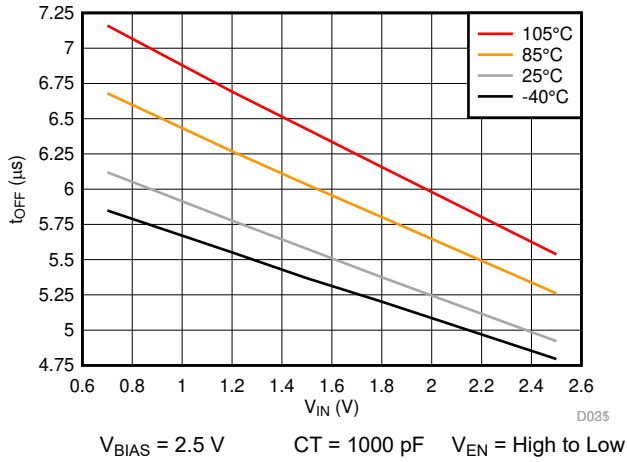

Figure 7-18. R_{PD} vs V_{OUT} , $V_{BIAS} = 5$ V

7.11 Typical Switching Characteristics



7.11 Typical Switching Characteristics



7.11 Typical Switching Characteristics (continued)

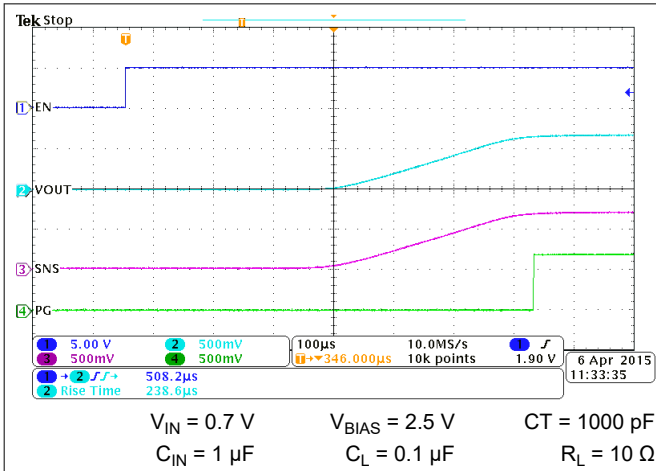

Figure 7-30. Turn-on Waveform, $V_{BIAS} = 2.5\text{ V}$

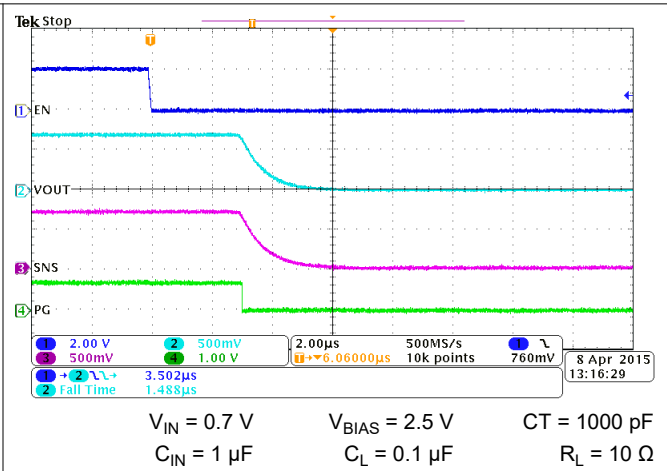

Figure 7-31. Turn-off Waveform, $V_{BIAS} = 2.5\text{ V}$

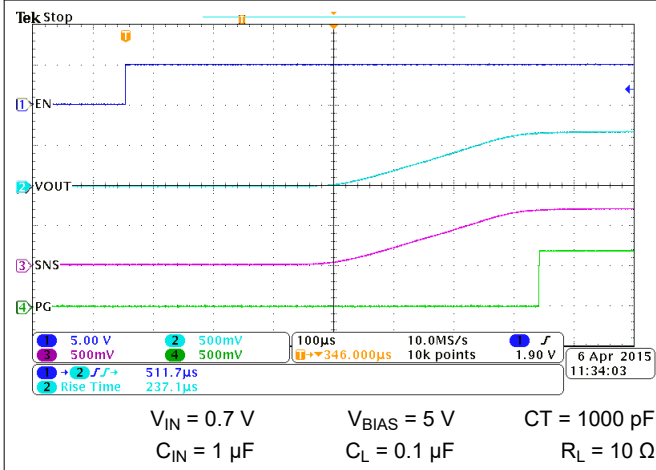

Figure 7-32. Turn-on Waveform, $V_{BIAS} = 5\text{ V}$

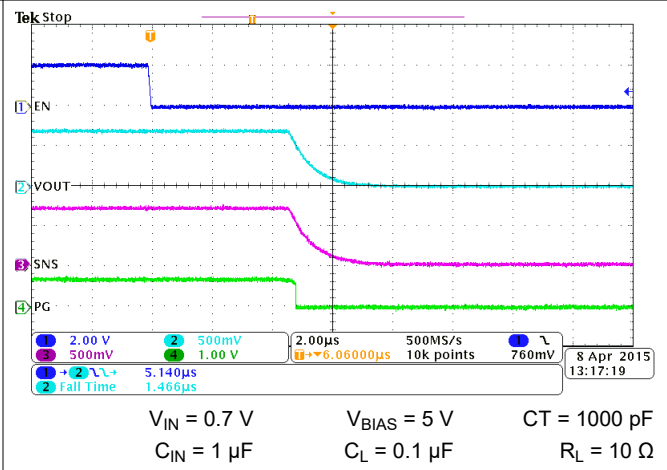

Figure 7-33. Turn-off Waveform, $V_{BIAS} = 5\text{ V}$

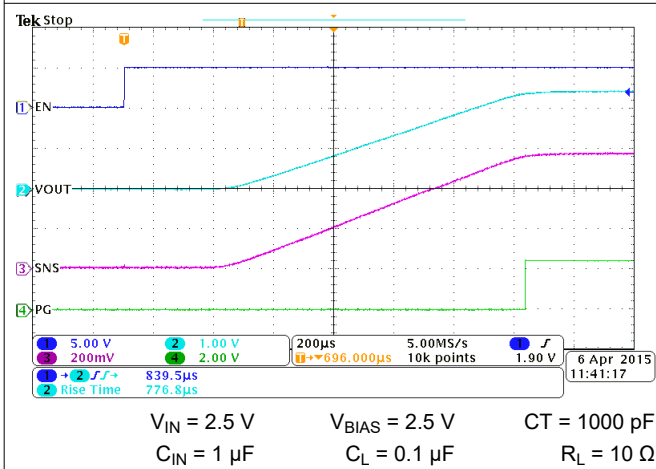

Figure 7-34. Turn-on Waveform, $V_{BIAS} = 2.5\text{ V}$

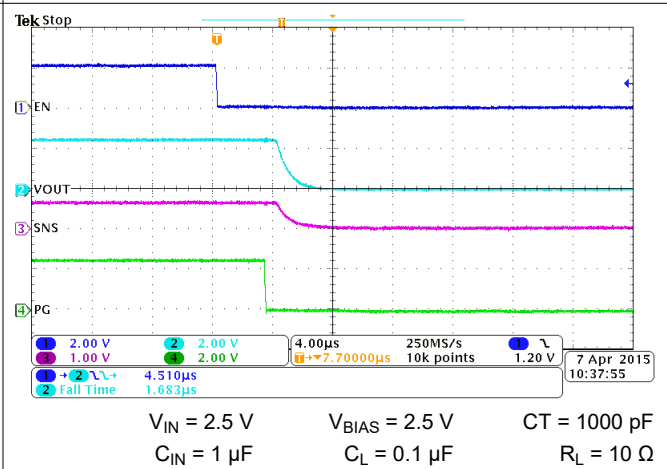

Figure 7-35. Turn-off Waveform, $V_{BIAS} = 2.5\text{ V}$

7.11 Typical Switching Characteristics (continued)

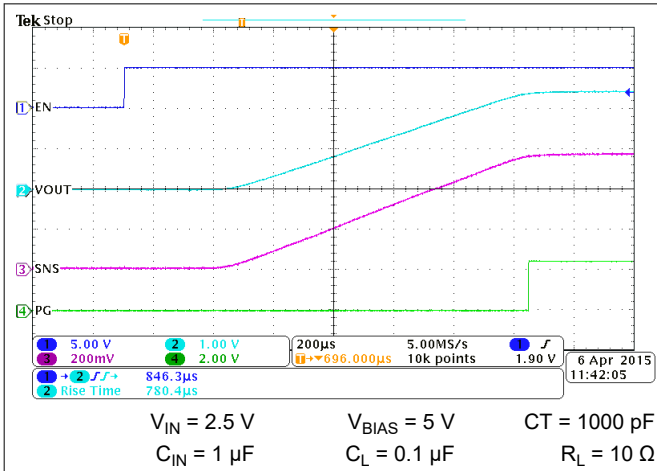

Figure 7-36. Turn-on Waveform, $V_{BIAS} = 5\text{ V}$

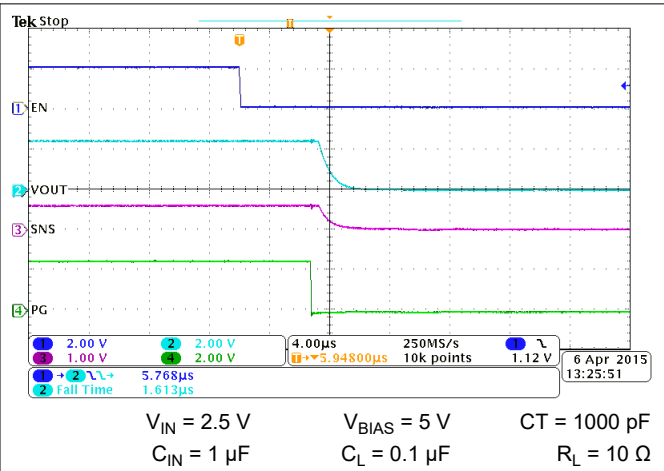

Figure 7-37. Turn-off Waveform, $V_{BIAS} = 5\text{ V}$

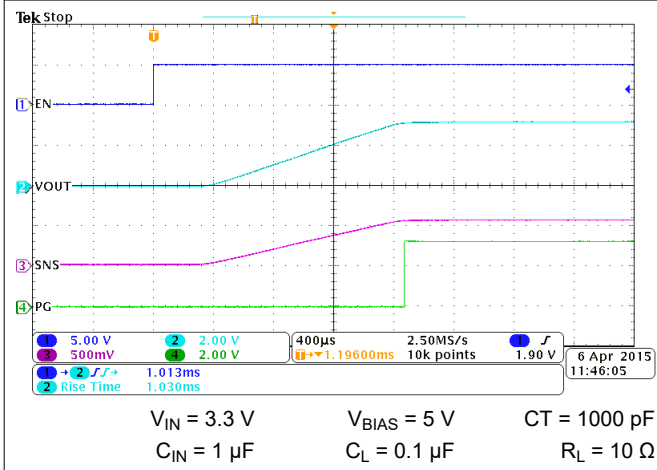

Figure 7-38. Turn-on Waveform, $V_{BIAS} = 5\text{ V}$

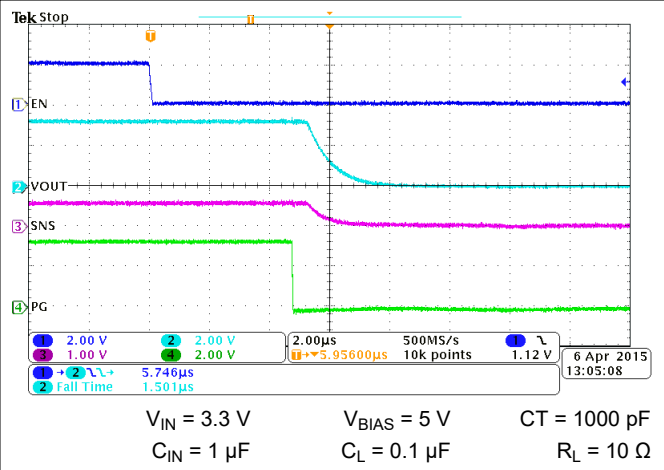

Figure 7-39. Turn-off Waveform, $V_{BIAS} = 5\text{ V}$

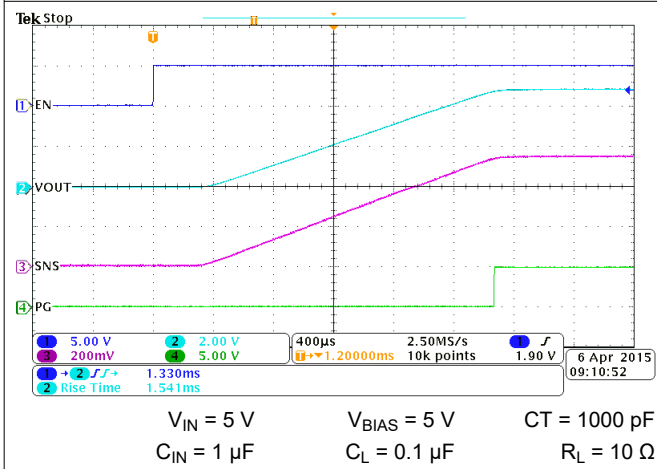

Figure 7-40. Turn-on Waveform, $V_{BIAS} = 5\text{ V}$

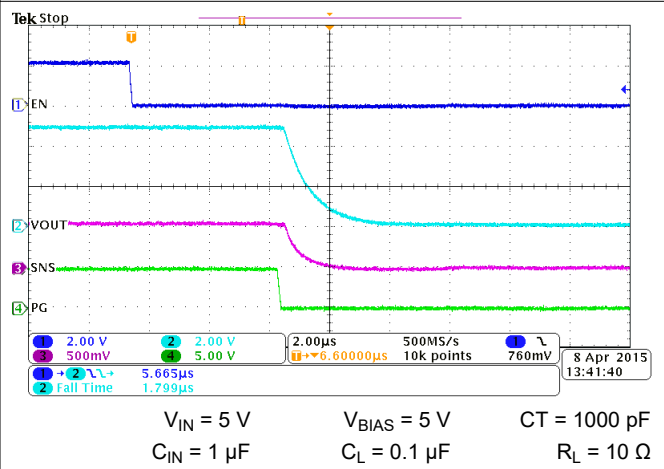

Figure 7-41. Turn-off Waveform, $V_{BIAS} = 5\text{ V}$

7.11 Typical Switching Characteristics (continued)

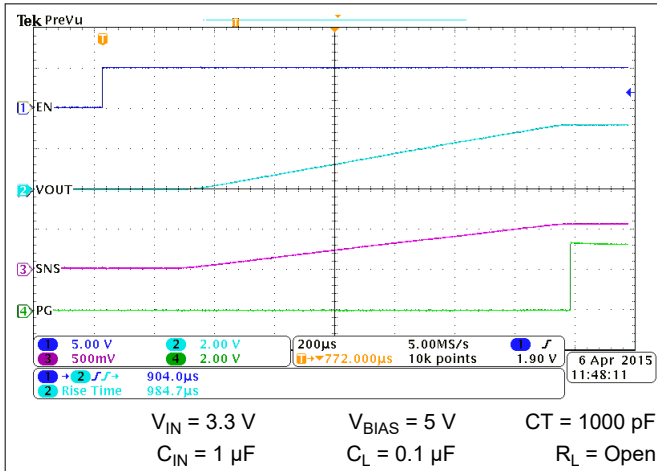

Figure 7-42. Turn-on Waveform, No Load

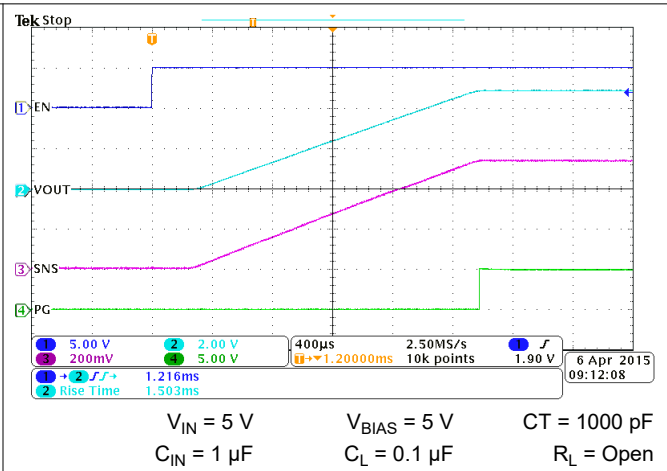

Figure 7-43. Turn-on Waveform, No Load

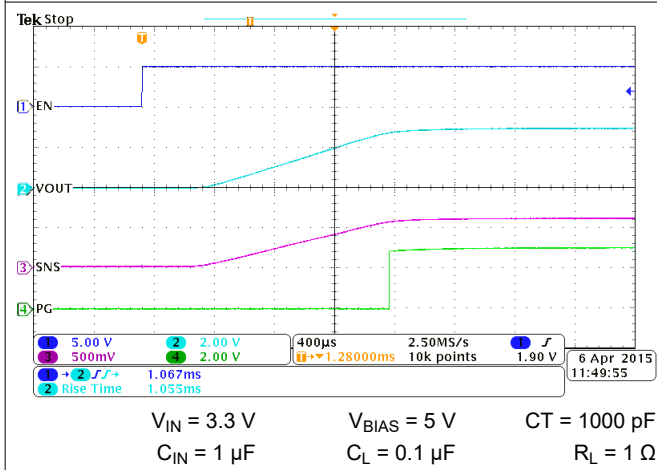

Figure 7-44. Turn-on Waveform, Heavy Load

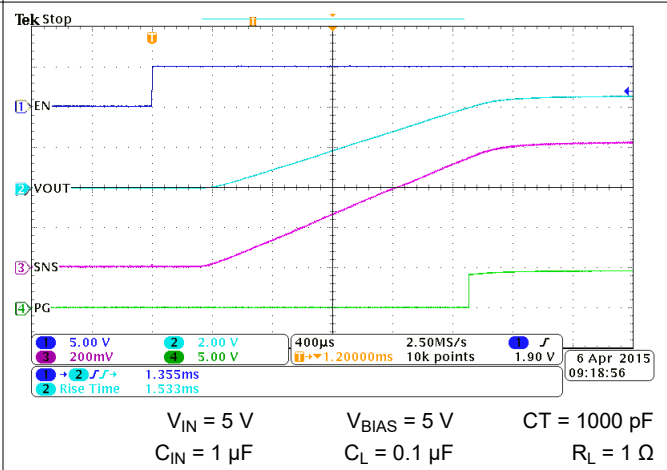

Figure 7-45. Turn-on Waveform, Heavy Load

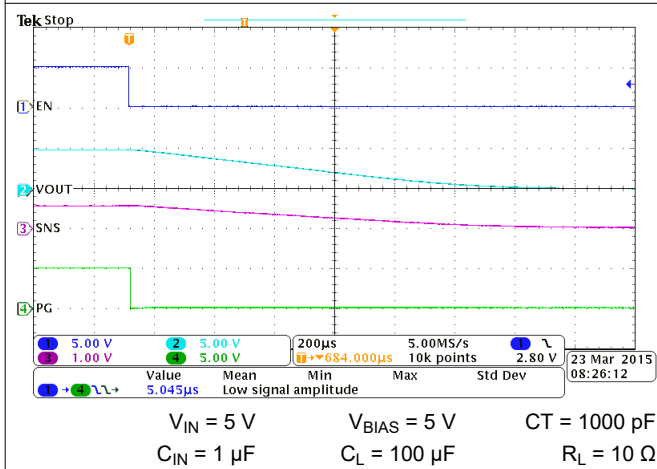

Figure 7-46. PG Response to EN Falling ($t_{DEGLITCH}$)

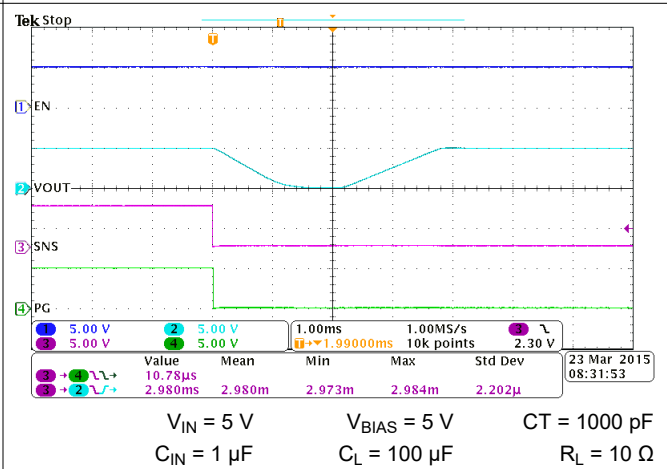

Figure 7-47. PG Response to SNS Falling With Auto-Restart ($t_{DEGLITCH}$ and $t_{RESTART}$)

7.11 Typical Switching Characteristics (continued)

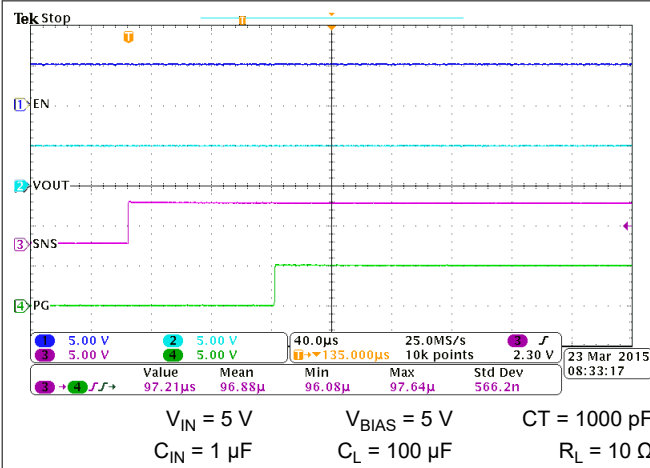

Figure 7-48. PG Response to SNS Rising (t_{BLANK})

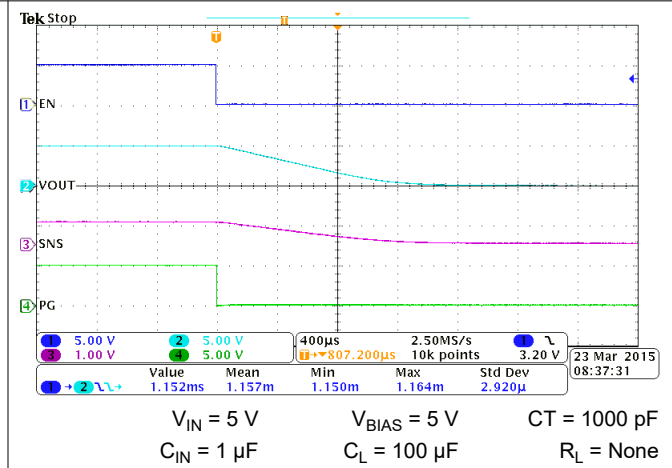

Figure 7-49. Quick Output Discharge of 100-µF Load (t_{DIS})

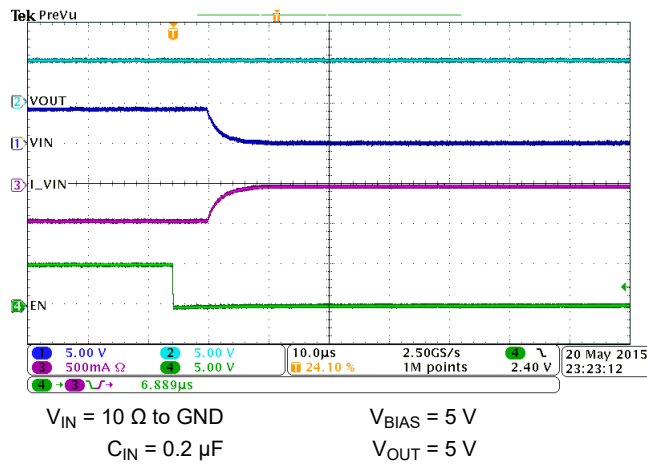
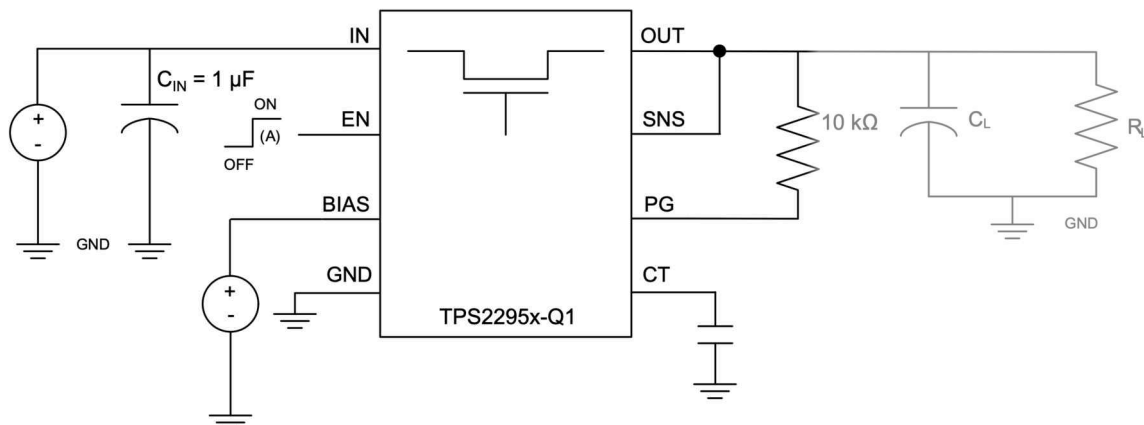

Figure 7-50. Reverse Current Blocking Response Time (t_{RCB})

8 Parameter Measurement Information



A. Rise and fall times of the control signal is 100 ns.

Figure 8-1. Timing Test Circuit

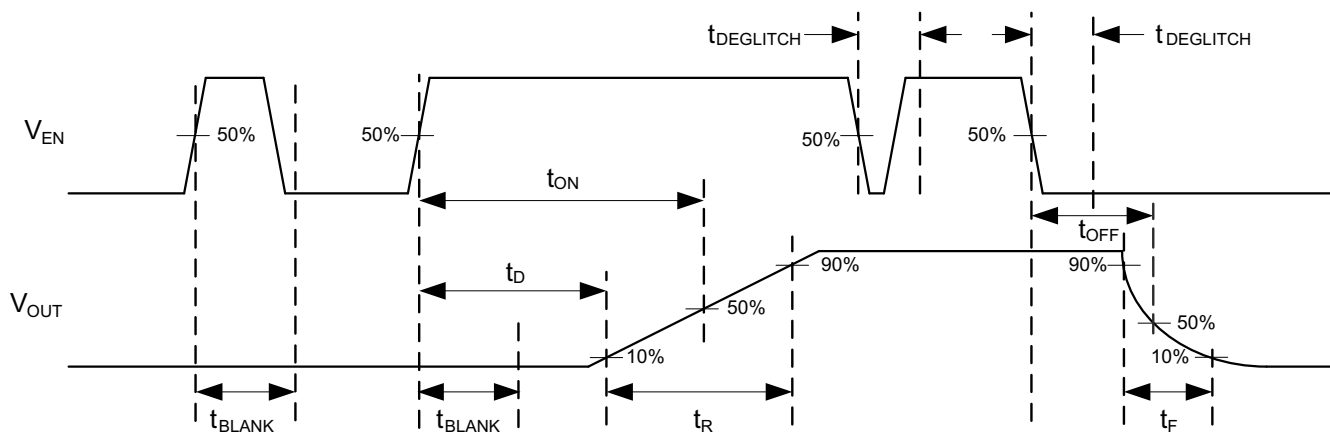

Figure 8-2. Timing Waveforms

9 Detailed Description

9.1 Overview

The TPS2295x-Q1 are 5.7-V, 5-A load switches in 10-pin SON packages. To reduce voltage drop for low voltage, high current rails the device implements a low-resistance N-channel MOSFET, which reduces the drop out voltage through the device at high currents. The integrated adjustable Undervoltage Lockout (UVLO) and adjustable Power Good (PG) threshold provides voltage monitoring as well as robust power sequencing.

The adjustable rise-time control of the device greatly reduces inrush current for a wide variety of bulk load capacitances, thereby reducing or eliminating power supply droop. The switch is independently controlled by an on and off input (EN), which is capable of interfacing directly with low-voltage control signals. A 15-Ω, on-chip load resistor integrates into the device for output quick discharge when the switch turns off.

During shutdown, the device has very low leakage currents, thereby reducing unnecessary leakages for downstream modules during standby. Integrated power monitoring functionality, control logic, driver, power supply, and output discharge FET eliminates the need for any external components, which reduces solution size and BOM count.

9.2 Functional Block Diagram

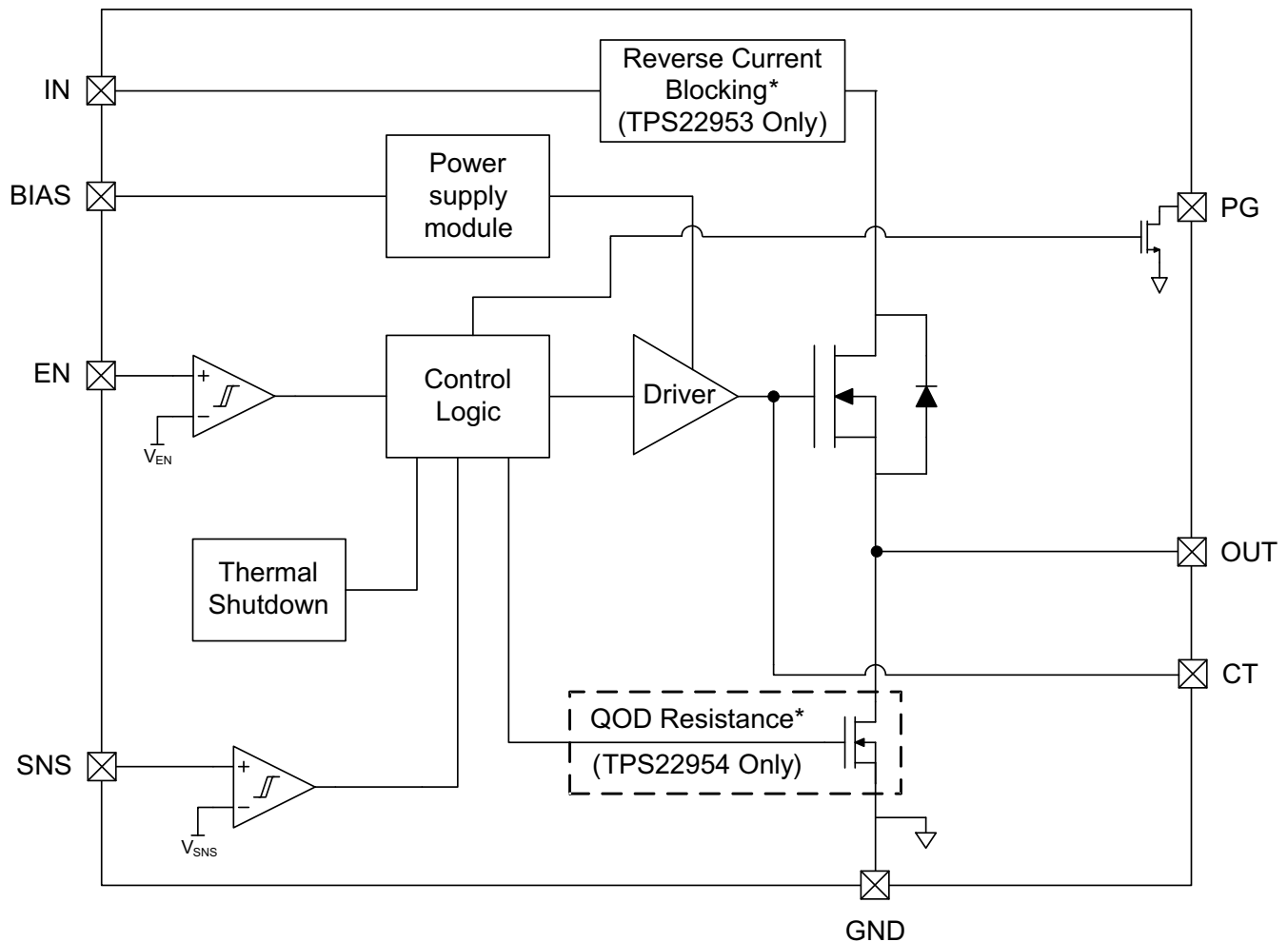

(*) Only active when the switch is disabled.

9.3 Feature Description

9.3.1 On and Off Control (EN Pin)

The EN pin controls the state of the switch. When the voltage on EN exceeds $V_{IH,EN}$ the switch enables. When EN goes below $V_{IL,EN}$ the switch disables.

The EN pin has a blanking time of t_{BLANK} on the rising edge after the $V_{IH,EN}$ threshold has been exceeded. The EN pin also has a de-glitch time of $t_{DEGLITCH}$ when the voltage has gone below $V_{IL,EN}$.

The EN pin can also be configured through an external resistor divider to monitor a voltage signal for input UVLO. See [Equation 1](#) and [Figure 9-1](#) on how to configure the EN pin for input UVLO.

$$V_{IH,EN} = V_{IN} \times \frac{R_{EN2}}{R_{EN1} + R_{EN2}} \quad (1)$$

where

- $V_{IH,EN}$ is the rising threshold of the EN pin (see the [Electrical Characteristics](#) table)
- V_{IN} is the input voltage being monitored (this can be V_{IN} , V_{BIAS} , or an external power supply)
- R_{EN1} , R_{EN2} are the resistor divider values

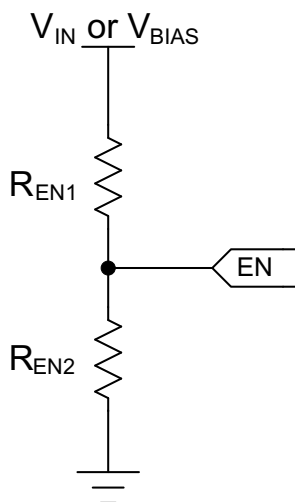

Figure 9-1. Resistor Divider (EN Pin)

9.3.2 Voltage Monitoring (SNS Pin)

The SNS pin of the device can be used to monitor the output voltage of the device or another voltage rail. The pin can be configured with an external resistor divider to set the desired trip point for the voltage being monitored or be tied to OUT directly. If the voltage on the SNS pin exceeds $V_{IH,SNS}$, the voltage being monitored on the SNS pin is considered to be valid high. The voltage on the SNS pin must be greater than $V_{IH,SNS}$ for at least t_{BLANK} before PG is asserted high. If the voltage on the SNS pin goes below $V_{IL,SNS}$, then the switch powers cycle (that is, the switch is disabled and re-enabled). For proper functionality of the device, this pin must not be left floating. If a resistor divider is not being used for voltage sensing, this pin can be tied directly to V_{OUT} .

The SNS pin has a blanking time of t_{BLANK} on the rising edge after the $V_{IH,SNS}$ threshold has been exceeded. The SNS pin has a de-glitch time of $t_{DEGLITCH}$ when the voltage has gone below $V_{IL,SNS}$.

See [Equation 2](#) and [Figure 9-2](#) on how to configure the SNS pin for voltage monitoring.

$$V_{IH,SNS} = V_{OUT} \times \frac{R_{SNS2}}{R_{SNS1} + R_{SNS2}} \quad (2)$$

where

- $V_{IH,SNS}$ is the the rising threshold of the SNS pin (see [Electrical Characteristics](#) table)
- V_{OUT} is the voltage on the OUTpin
- R_{SNS1} , R_{SNS2} are the resistor divider values

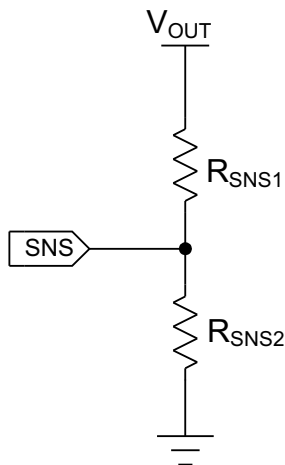

Figure 9-2. Voltage Divdier (SNS Pin)

9.3.3 Power Good (PG Pin)

The PG pin is only asserted high when the voltage on EN exceeds $V_{IH,EN}$ and the voltage on SNS exceeds $V_{IH,SNS}$. There is a t_{BLANK} time, typically 100 μ s, between the SNS voltage exceeding $V_{IH,SNS}$ and PG being asserted high. If the voltage on EN goes below $V_{IL,EN}$ or the voltage on SNS goes below $V_{IL,SNS}$, PG is de-asserted. There is a $t_{DEGLITCH}$ time, typically 5 μ s, between the EN voltage or SNS voltage going below their respective V_{IL} levels and PG being pulled low.

PG is an open drain pin and must be pulled up with a pullup resistor. Be sure to never exceed the maximum operating voltage on this pin. If PG is not being used in the application, tie it to GND for proper device functionality.

For proper PG operation, the BIAS voltage must be within the recommended operating range. In systems that are very sensitive to noise or have long PG traces, TI recommends to add a small capacitance from PG to GND for decoupling.

9.3.4 Supervisor Fault Detection and Automatic Restart

The falling edge of the SNS pin below $V_{IL,SNS}$ is considered a fault case and causes the load switch to be disabled for $t_{RESTART}$ (typically 2 ms). After the $t_{RESTART}$ time, the switch is automatically re-enabled as long as EN is still above $V_{IH,EN}$. In the case, the SNS pin is being used to monitor V_{OUT} or a downstream voltage. The restart helps to protect against excessive overcurrent if there is a quick short to GND. See [Figure 9-3](#).

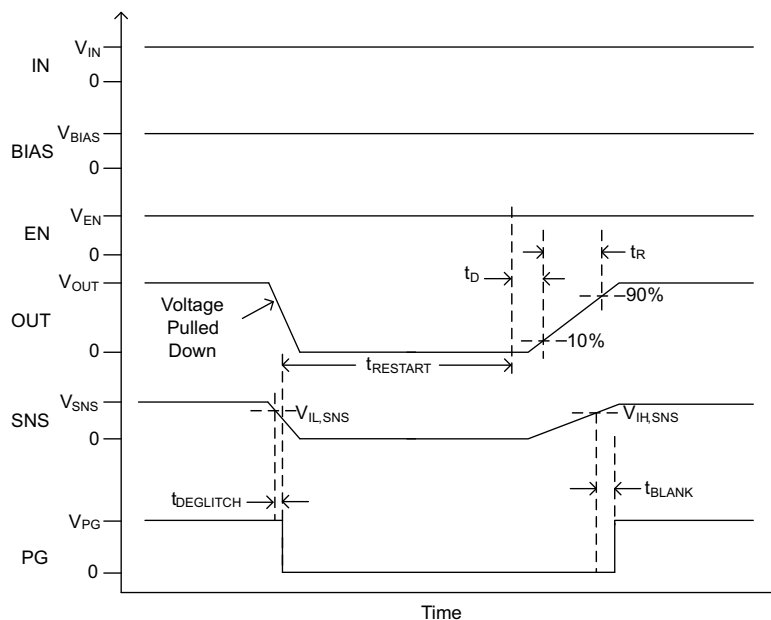

Figure 9-3. Automatic Restart After Quick Short to GND

9.3.5 Manual Restart

The falling edge of the SNS pin below $V_{IL,SNS}$ is considered a fault case and causes the load switch to be disabled for $t_{RESTART}$ (typically 2 ms). The SNS pin can be driven by an MCU to manually reset the load switch. After the $t_{RESTART}$ time, the switch is automatically re-enabled as long as EN is still above $V_{IH,EN}$, even if SNS is held low. The PG pin stays low until the switch is re-enabled and the SNS pin rises above $V_{IH,SNS}$. See [Figure 9-4](#).

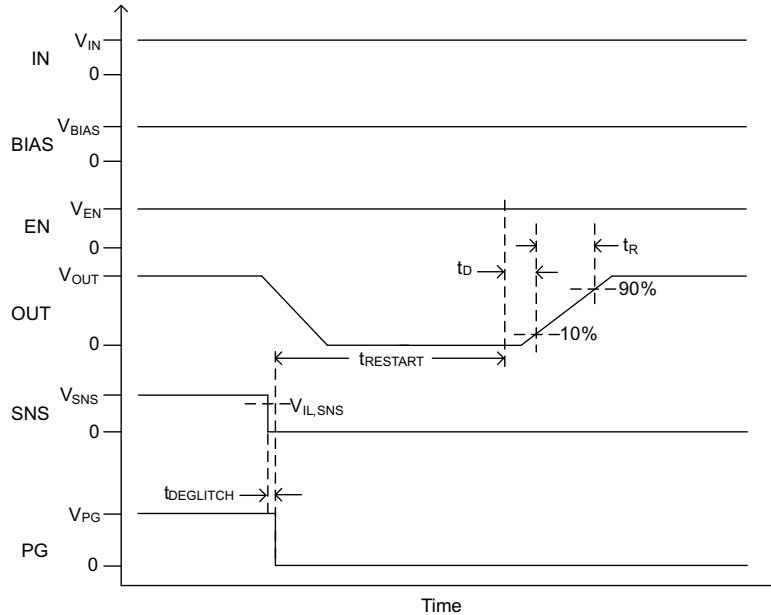

Figure 9-4. Manual Restart (SNS Held Low)

If the SNS pin is brought above $V_{IH,SNS}$ within the $t_{RESTART}$ time, the switch still waits to re-enable. The PG pin also stays low until t_{BLANK} after switch is re-enabled. In this case, PG indicates when the switch is enabled and capable of being reset again. See [Figure 9-5](#).

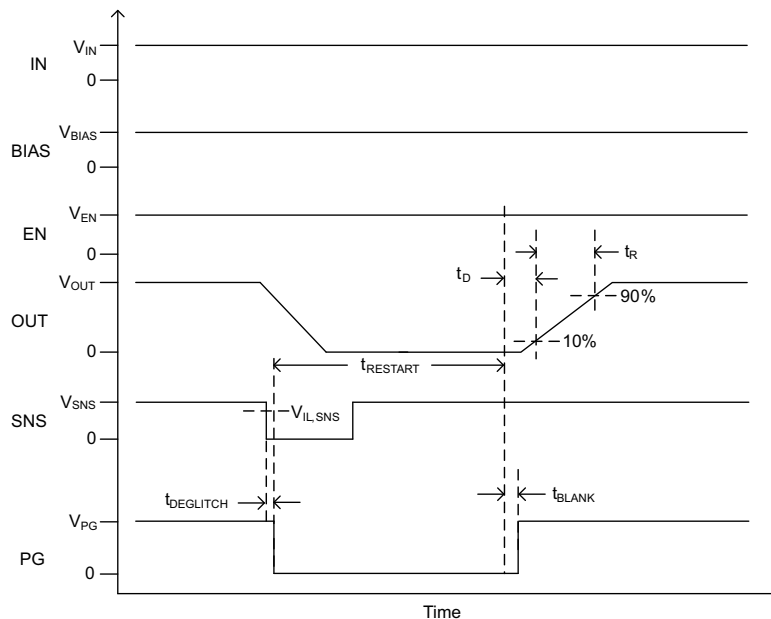

Figure 9-5. Manual Restart (SNS Toggled Low to High)

9.3.6 Thermal Shutdown

If the junction temperature of the device exceeds T_{SD} , the switch disables. The device enables after the junction temperature drops by TSD_{HYS} as long as EN is still greater than $V_{IH,EN}$.

9.3.7 Reverse Current Blocking (TPS22953-Q1 Only)

When the switch disables (either by de-asserting EN or SNS , triggering thermal shutdown, or losing power), the reverse current blocking (RCB) feature of the device engages within t_{RCB} , typically 10 μs . After the RCB engages, the reverse current from the OUT pin to the IN pin is limited to $I_{RCB,IN}$, typically 0.01 μA .

9.3.8 Quick Output Discharge (QOD) (TPS22954-Q1 Only)

The Quick Output Discharge (QOD) transistor is engaged indefinitely whenever the switch is disabled and the recommended V_{BIAS} voltage is met. During this state, the QOD resistance (R_{PD}) discharges V_{OUT} to GND. TI does not recommend to apply a continuous DC voltage to OUT when the device is disabled.

The QOD transistor can remain active for a short period of time even after V_{BIAS} loses power. This brief period of time is defined as t_{DIS} . For best results, TI recommends the device get disabled before V_{BIAS} goes below the minimum recommended voltage. The waveform in [Figure 9-6](#) shows the behavior when power is applied and then removed in a typical application.

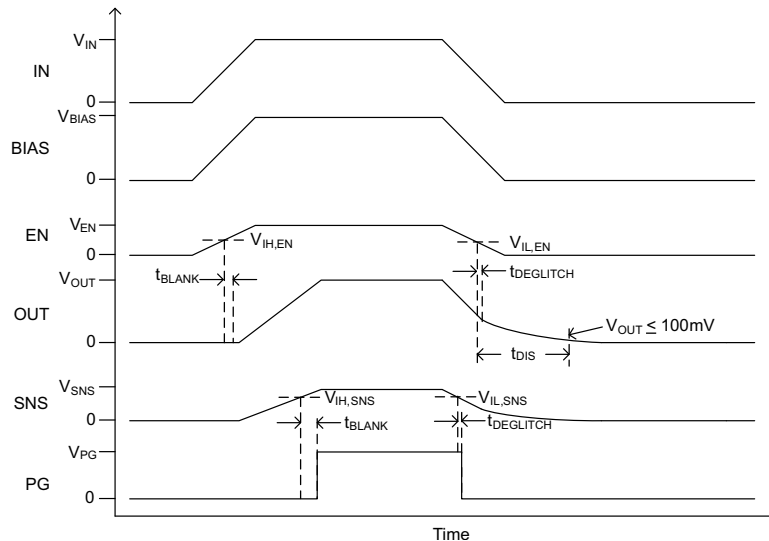

Figure 9-6. Power Applied and Then Removed in a Typical Application

At the end of the t_{DIS} time, it is not assured that V_{OUT} is 0 V because the final voltage is dependent upon the initial voltage and the C_L capacitor. The final V_{OUT} can be calculated with [Equation 3](#) for a given initial voltage and C_L capacitor.

$$V_f = V_o \times e^{\frac{-t}{RC}} \quad (3)$$

where

- V_f is the final V_{OUT} voltage
- V_o is the initial V_{OUT} voltage
- R is the the value of the output discharge resistor, R_{PD} (see the [Electrical Characteristics](#) table)
- C is the output bulk capacitance on OUT

9.3.9 V_{IN} and V_{BIAS} Voltage Range

For optimal R_{ON} performance, make sure $V_{IN} \leq V_{BIAS}$. The device is still functional if $V_{IN} > V_{BIAS}$ but it exhibits R_{ON} greater than what is listed in the [Electrical Characteristics](#) table. See [Figure 9-7](#) for an example of a typical

device. Notice the increasing R_{ON} as V_{IN} increases. Be sure to never exceed the maximum voltage rating for V_{IN} and V_{BIAS} .

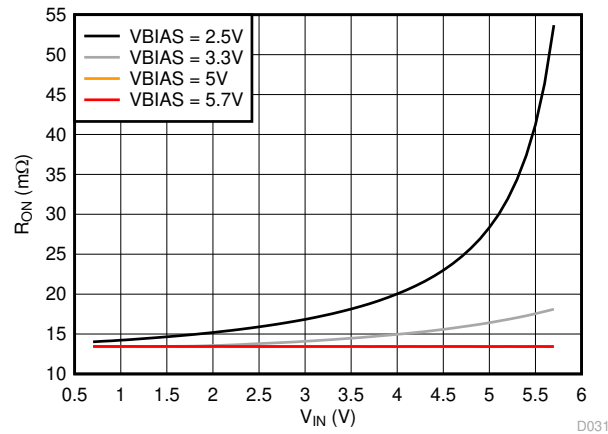

Figure 9-7. R_{ON} When $V_{IN} > V_{BIAS}$

9.3.10 Adjustable Rise Time (CT Pin)

A capacitor to GND on the CT pin sets the slew rate for V_{OUT} . An appropriate capacitance value must be placed on CT such that the I_{MAX} and I_{PLS} specifications of the device are not violated. The capacitor to GND on the CT pin must be rated for 25 V or higher. Equation 4 shows an approximate formula for the relationship between CT (except for CT = open) and the slew rate for any V_{BIAS} .

$$SR = 0.35 \times CT + 20 \tag{4}$$

where

- SR is the slew rate (in $\mu s/V$).
- CT is the capacitance value on the CT terminal (in pF).
- The units for the constant 20 are $\mu s/V$.
- The units for the constant 0.35 are $\mu s/(V \cdot pF)$.

Rise time can be calculated by multiplying the input voltage (typically 10% to 90%) by the slew rate. Table 9-1 contains rise time values measured on a typical device.

Table 9-1. Rise Time

CTx (pF)	RISE TIME (μs) 10% – 90%, $C_L = 0.1 \mu F$, $V_{BIAS} = 2.5 V$ to $5.7 V$, $R_L = 10\text{-}\Omega$ LOAD. TYPICAL VALUES AT 25°C, 25-V X7R 10% CERAMIC CAP					
	5 V	3.3 V	1.8 V	1.5 V	1.2 V	0.7 V
Open	140	98	62	54	46	32
220	444	301	175	150	124	81
470	767	518	299	255	210	133
1000	1492	994	562	474	387	245
2200	3105	2050	1151	961	787	490
4700	6420	4246	2365	1980	1612	998
10000	14059	9339	5183	4331	3533	2197

9.3.11 Power Sequencing

The TPS2295x-Q1 operates regardless of power-on and power-off sequencing order. The order in which voltages are applied to IN, BIAS, and EN does not damage the device as long as the voltages do not exceed the absolute maximum operating conditions. If voltage is applied to EN before IN and BIAS, the slew rate of VOUT is not controlled. Also, turning off IN or BIAS while EN is high does not damage the device.

9.4 Device Functional Modes

[Table 9-2](#) describes what the OUT pin is connected to for a particular device as determined by the EN pin.

Table 9-2. Function Table

EN	TPS22953-Q1	TPS22954-Q1
L	OPEN	R _{PD} to GND
H	IN	IN

10 Application and Implementation

Note

Information in the following applications sections is not part of the TI component specification, and TI does not warrant its accuracy or completeness. TI's customers are responsible for determining suitability of components for their purposes, as well as validating and testing their design implementation to confirm system functionality.

10.1 Application Information

This section highlights some of the design considerations when implementing this device in various applications. A PSPICE model for this device is also available on www.ti.com for further aid.

10.1.1 Input to Output Voltage Drop

The input to output voltage drop in the device is determined by the R_{ON} of the device and the load current. The R_{ON} of the device depends upon the V_{IN} and V_{BIAS} conditions of the device. Refer to the R_{ON} specification of the device in the [Electrical Characteristics](#) table of this data sheet. After the R_{ON} of the device is determined based upon the V_{IN} and V_{BIAS} voltage conditions, use [Equation 5](#) to calculate the input to output voltage drop.

$$\Delta V = I_{LOAD} \times R_{ON} \quad (5)$$

where

- ΔV is the voltage drop from IN to OUT
- I_{LOAD} is the load current
- R_{ON} is the On-Resistance of the device for a specific V_{IN} and V_{BIAS}

An appropriate I_{LOAD} must be chosen such that the I_{MAX} specification of the device is not violated.

10.1.2 Thermal Considerations

The maximum IC junction temperature must be restricted to just under the thermal shutdown (T_{SD}) limit of the device. Use [Equation 6](#) to calculate the maximum allowable dissipation, $P_{D(max)}$ for a given output current and ambient temperature.

$$P_{D(max)} = \frac{T_{J(max)} - T_A}{\theta_{JA}} \quad (6)$$

where

- $P_{D(max)}$ is the maximum allowable power dissipation.
- $T_{J(max)}$ is the maximum allowable junction temperature before hitting thermal shutdown (see the [Electrical Characteristics](#) table).
- T_A is the ambient temperature of the device.
- θ_{JA} is the junction to air thermal impedance. See the [Thermal Information](#) section. This parameter is highly dependent upon board layout.

10.1.3 Automatic Power Sequencing

The PG pin of the TPS2295x-Q1 allows for automatic sequencing of multiple system rails or loads. The accurate SNS voltage monitoring ensures the first rail is up before the next starts to turn on. This approach provides robust system sequencing and reduces the total inrush current by preventing overlap. Figure 10-1 shows how two rails can be sequenced. There is no limit to the number of rails that can be sequenced in this way.

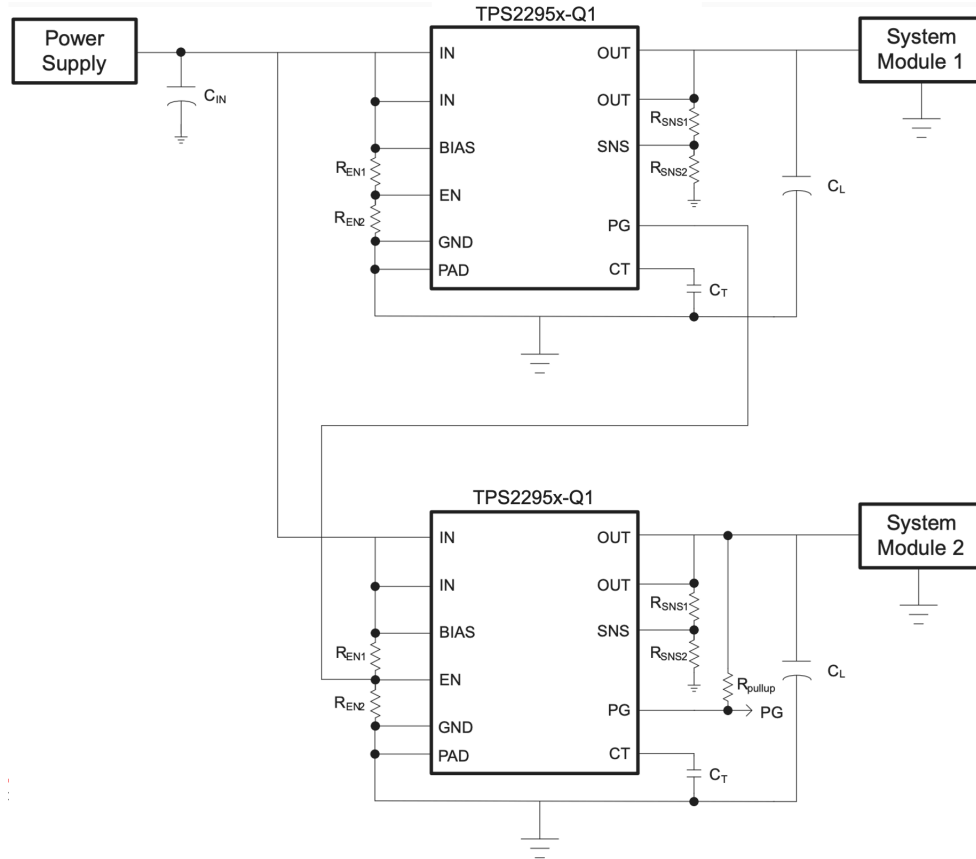

Figure 10-1. Power Sequencing with PG Control Schematic

10.1.4 Monitoring a Downstream Voltage

The SNS pin can be used to monitor other system voltages in addition to V_{OUT} . The status of the monitored voltage are indicated by the PG pin which can be pulled up to V_{OUT} or another voltage. Figure 10-2 shows an example of the TPS2295x-Q1 monitoring the output of a downstream DC/DC regulator. In this case, the switch turns on when the power supply is above the UVLO, but the PG is not asserted until the DC/DC regulator has started up.

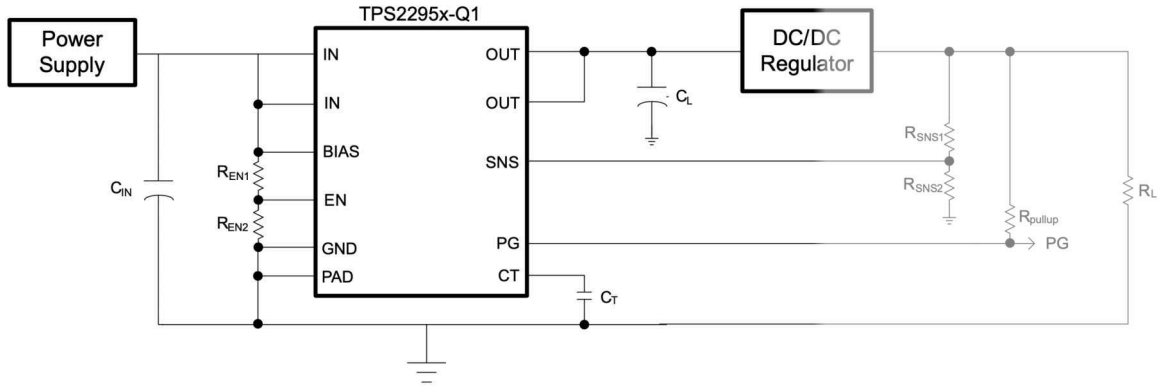

Figure 10-2. Monitoring a Downstream Voltage Schematic

In this application, if the DC/DC Regulator is shut down, the supervisor registers this as a fault case and resets the load switch.

10.1.5 Monitoring the Input Voltage

The SNS pin can also be used to monitor V_{IN} in the case a MCU GPIO is being used to control the EN. This event allows PG to report on the status of the input voltage when the switch is enabled. See Figure 10-3.

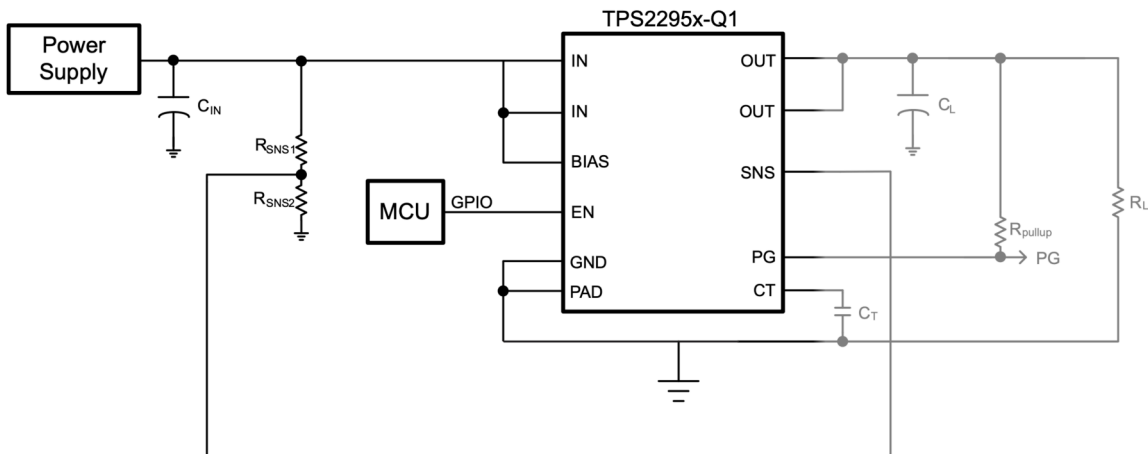

Figure 10-3. Monitoring the Input Voltage Schematic

10.1.6 Break-Before-Make Power MUX (TPS22953-Q1 Only)

The reverse current blocking feature of the TPS22953-Q1 makes it suitable for power multiplexing (MUXing) between two power supplies with different voltages. The SNS and PG pin can be configured to implement break-before-make logic. The circuit in Figure 10-4 shows how the detection of power supply 1 can be used to disable the load switch for power supply 2. By tying the SNS of Load Switch 1 directly to the input, its PG pin is pulled up as soon as the device is enabled.

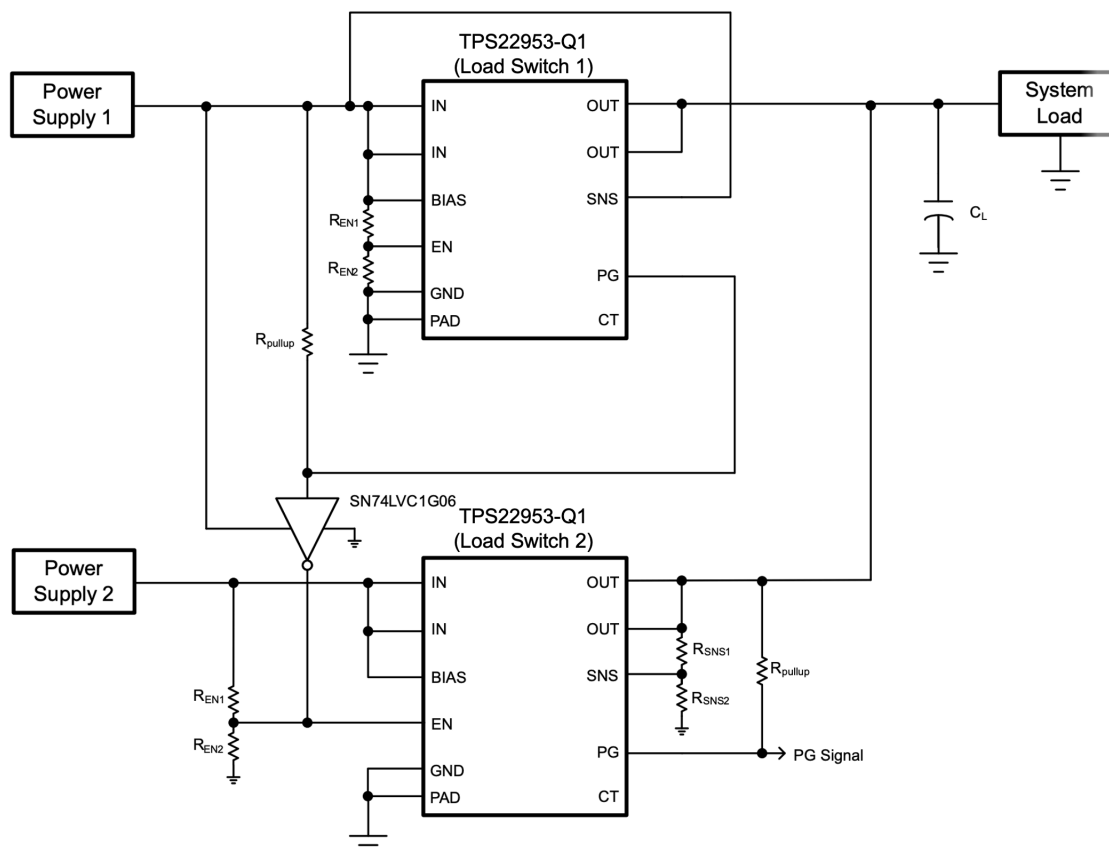

Figure 10-4. Break-Before-Make Power MUX Schematic

The break-before-make logic ensures that power supply 2 is completely disconnected before power supply 1 is connected. This approach provides very robust reverse current blocking. However, in most cases, this approach also results in a dip in the output voltage when switching between supplies.

The amount of voltage dip depends on the loading, the output capacitance, and the turn-on delay of the load switch. In this application, leaving the CT pin open results in the shortest turn-on delay and minimizes the output voltage dip.

Table 10-1 summarizes the logic of the PG Signal for Figure 10-4.

Table 10-1. Break-Before-Make PG Signal

PG Signal	Indication
H	Power supply 1 not present. System powered from power supply 2.
L	Power supply 1 present. System powered from power supply 1.

10.1.7 Make-Before-Break Power MUX (TPS22953-Q1 Only)

The reverse current blocking feature of the TPS22953-Q1 makes it suitable for power multiplexing (MUXing) between two power supplies with different voltages. The SNS and PG pin can be configured to implement make-before-break logic. The circuit in Figure 10-5 shows how the detection of Load Switch 1 turning on can be used to disable the load switch for power supply 2. By tying SNS to the Load, the PG is pulled up when the output voltage starts to rise. This event disables an active low load switch such as the TPS22910A.

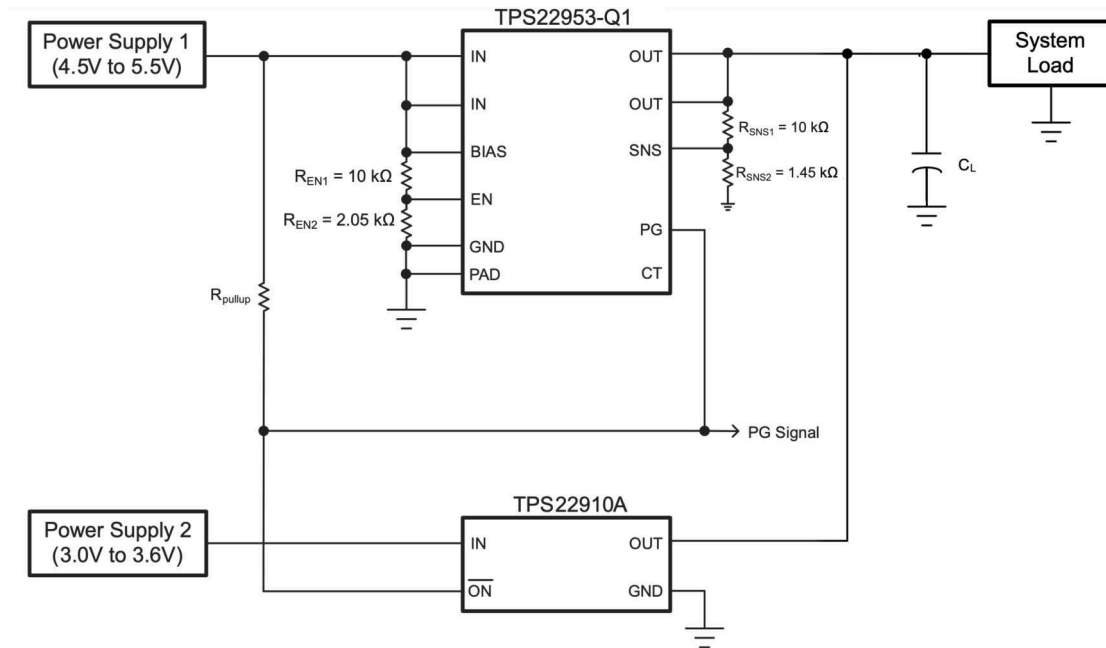

Figure 10-5. Make-Before-Break Power MUX Schematic

The make-before-break logic ensures that power supply 2 is not disconnected until power supply 1 is connected. Unlike break-before-make logic, this approach is ideal for preventing voltage dip on the output when switching between supplies. However, in most cases, this approach also results in temporary reverse current flow.

The TPS22910A is well suited for this application because it can detect and block reverse current even before it is disabled by the TPS22953-Q1 PG signal. Also, the active low enable of the TPS22910A eliminates the need for an inverter as shown in the previous example.

To ensure correct logic, the SNS pin must be configured to toggle PG when the load voltage is between the two supply voltages (3.6 V to 4.5 V). The SNS resistor values in Figure 10-5 are assuming a tolerance of $\pm 1\%$ or better.

Table 10-2 summarizes the logic of the PG Signal for Figure 10-5.

Table 10-2. Make-Before-Break PG Signal

PG Signal	Indication
H	Power supply 1 present. System powered from power supply 1.
L	Power supply 1 not present. System powered from power supply 2.

10.2 Typical Application

This application demonstrates how the TPS2295x-Q1 can be used to limit inrush current to output capacitance.

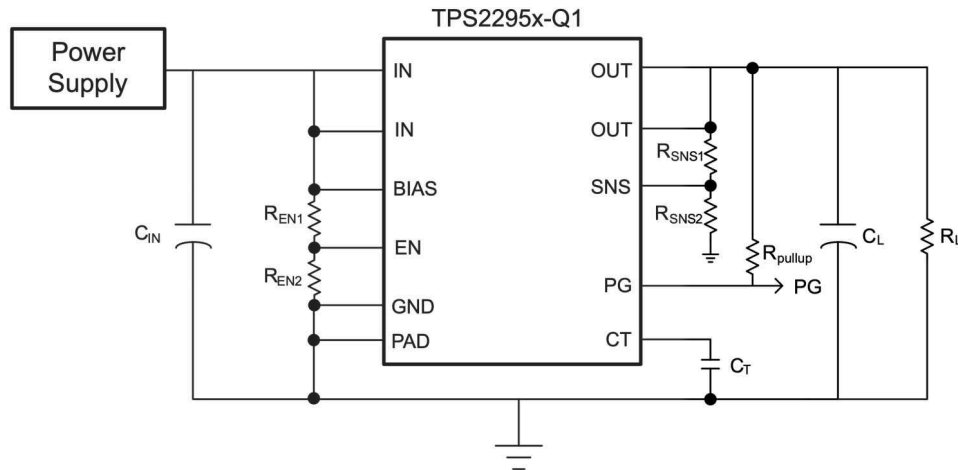

Figure 10-6. Powering a Downstream Module Schematic

10.2.1 Design Requirements

For this design example, use the input parameters shown in Table 10-3.

Table 10-3. Design Parameters

DESIGN PARAMETER	EXAMPLE VALUE
V_{IN}	3.3 V
V_{BIAS}	5 V
C_L	47 μ F
Maximum acceptable inrush current	150 mA
R_L	None

10.2.2 Detailed Design Procedure

To begin the design process, the designer must know the following:

- Input voltage
- BIAS voltage
- Load current
- Load capacitance
- Maximum acceptable inrush current

10.2.2.1 Inrush Current

Use Equation 7 to determine how much inrush current is caused by the C_L capacitor.

$$I_{INRUSH} = C_L \times \frac{dV_{OUT}}{dt} \quad (7)$$

where

- I_{INRUSH} is the amount of inrush caused by C_L
- C_L is the load capacitance on V_{OUT}
- dt is the V_{OUT} rise time (typically 10% to 90%)
- dV_{OUT} is the change in V_{OUT} Voltage (typically 10% to 90%)

In this case, a Slew Rate slower than 314 $\mu\text{s}/\text{V}$ is required to meet the maximum acceptable inrush requirement. Equation 4 can be used to estimate the CT capacitance (as shown in Equation 8 and Equation 9) required for this slew rate.

$$314 \mu\text{s}/\text{V} = 0.35 \times \text{CT} + 20 \quad (8)$$

$$\text{CT} = 840 \text{ pF} \quad (9)$$

10.2.3 Application Curves

The following Application Curves show the inrush with multiple different CT values. These curves show only a CT capacitance greater than 840 pF results in the acceptable inrush current of 150 mA.

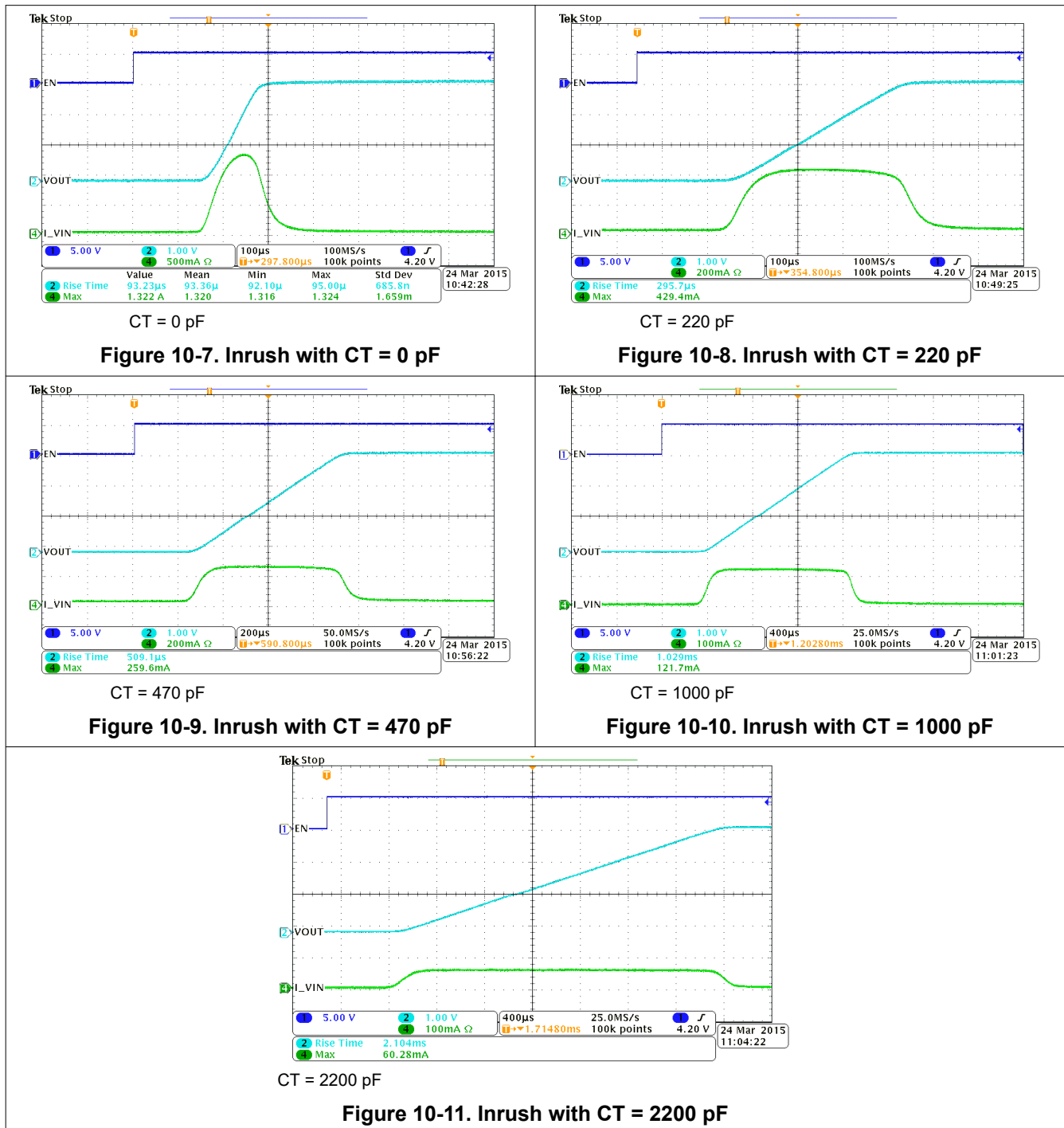

11 Power Supply Recommendations

The device is designed to operate from a V_{BIAS} range of 2.5 V to 5.7 V and a V_{IN} range of 0.7 V to 5.7 V. The power supply must be well regulated and placed as close to the device terminals as possible. The power supply must be able to withstand all transient and load current steps. In most situations, using an input capacitance of 1 μF is sufficient to prevent the supply voltage from dipping when the switch is turned on. In cases where the power supply is slow to respond to a large transient current or large load current step, additional bulk capacitance can be required on the input.

The requirements for larger input capacitance can be mitigated by adding additional capacitance to the CT pin. This action causes the load switch to turn on more slowly. Not only does this event reduce transient inrush current, but it also gives the power supply more time to respond to the load current step.

12 Layout

12.1 Layout Guidelines

- Input and Output traces must be as short and wide as possible to accommodate for high current.
- Use vias under the exposed thermal pad for thermal relief for high current operation.
- The CT Capacitor must be placed as close as possible to the device to minimize parasitic trace capacitance. TI recommends to cutout copper on other layers directly below CT to minimize parasitic capacitance.
- The IN terminal must be bypassed to ground with low ESR ceramic bypass capacitors. The typical recommended bypass capacitance is ceramic with X5R or X7R dielectric. This capacitor must be placed as close to the device pins as possible.
- The OUT terminal must be bypassed to ground with low ESR ceramic bypass capacitors. The typical recommended bypass capacitance is ceramic with X5R or X7R dielectric. This capacitor must be placed as close to the device pins as possible.
- The BIAS terminal must be bypassed to ground with low ESR ceramic bypass capacitors. The typical recommended bypass capacitance is ceramic with X5R or X7R dielectric.

12.2 Layout Example

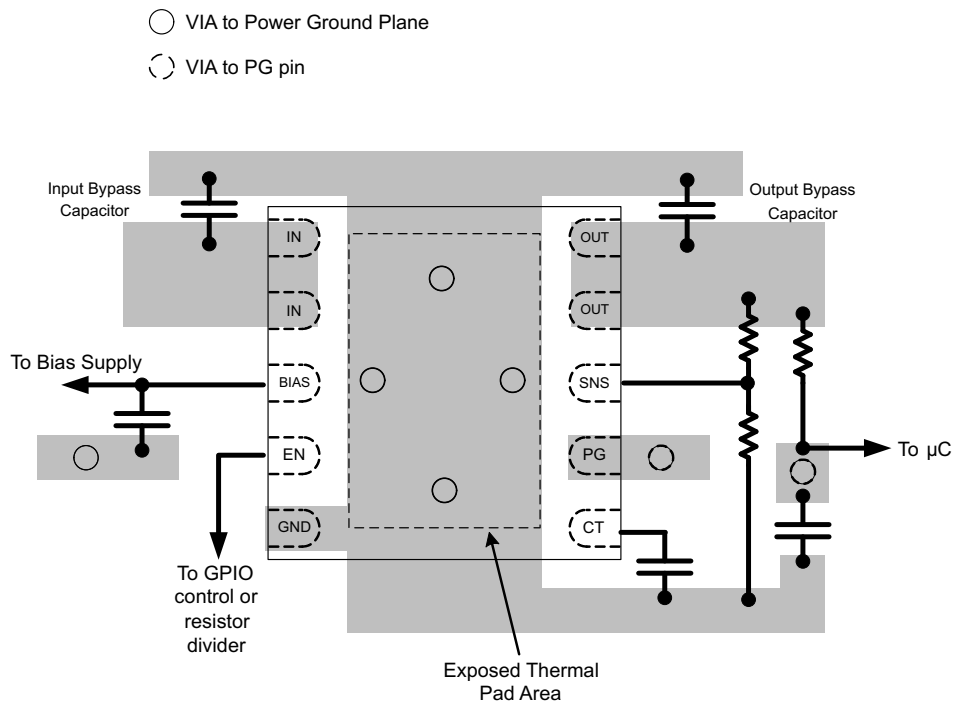

Figure 12-1. Recommended Board Layout

13 Device and Documentation Support

13.1 Documentation Support

13.1.1 Related Documentation

For related documentation see the following:

- Texas Instruments, [TPS22953/54 5.7-V, 5-A, 14-mΩ On-Resistance Load Switch user's guide](#)
- Texas Instruments, [Basics of Load Switches application note](#)
- Texas Instruments, [Managing Inrush Current application note](#)
- Texas Instruments, [Reverse Current Protection in Load Switches application note](#)
- Texas Instruments, [Quiescent Current vs Shutdown Current for Load Switch Power Consumption application note](#)
- Texas Instruments, [Load Switch Thermal Considerations application note](#)

13.2 Receiving Notification of Documentation Updates

To receive notification of documentation updates, navigate to the device product folder on [ti.com](#). Click on [Subscribe to updates](#) to register and receive a weekly digest of any product information that has changed. For change details, review the revision history included in any revised document.

13.3 Support Resources

[TI E2E™ support forums](#) are an engineer's go-to source for fast, verified answers and design help — straight from the experts. Search existing answers or ask your own question to get the quick design help you need.

Linked content is provided "AS IS" by the respective contributors. They do not constitute TI specifications and do not necessarily reflect TI's views; see TI's [Terms of Use](#).

13.4 Trademarks

TI E2E™ is a trademark of Texas Instruments.

All trademarks are the property of their respective owners.

13.5 Electrostatic Discharge Caution



This integrated circuit can be damaged by ESD. Texas Instruments recommends that all integrated circuits be handled with appropriate precautions. Failure to observe proper handling and installation procedures can cause damage.

ESD damage can range from subtle performance degradation to complete device failure. Precision integrated circuits may be more susceptible to damage because very small parametric changes could cause the device not to meet its published specifications.

13.6 Glossary

[TI Glossary](#) This glossary lists and explains terms, acronyms, and definitions.

14 Mechanical, Packaging, and Orderable Information

The following pages include mechanical, packaging, and orderable information. This information is the most current data available for the designated devices. This data is subject to change without notice and revision of this document. For browser-based versions of this data sheet, refer to the left-hand navigation.

PACKAGING INFORMATION

Orderable Device	Status (1)	Package Type	Package Drawing	Pins	Package Qty	Eco Plan (2)	Lead finish/ Ball material (6)	MSL Peak Temp (3)	Op Temp (°C)	Device Marking (4/5)	Samples
PTPS22953QDQCRQ1	ACTIVE	WSON	DQC	10	3000	TBD	Call TI	Call TI	-40 to 125		Samples
PTPS22954QDQCRQ1	ACTIVE	WSON	DQC	10	3000	TBD	Call TI	Call TI	-40 to 125		Samples
TPS22953QDQCRQ1	ACTIVE	WSON	DQC	10	3000	RoHS & Green	NIPDAU	Level-2-260C-1 YEAR	-40 to 125	953Q1	Samples
TPS22954QDQCRQ1	ACTIVE	WSON	DQC	10	3000	RoHS & Green	NIPDAU	Level-2-260C-1 YEAR	-40 to 125	954Q1	Samples

(1) The marketing status values are defined as follows:

ACTIVE: Product device recommended for new designs.

LIFEBUY: TI has announced that the device will be discontinued, and a lifetime-buy period is in effect.

NRND: Not recommended for new designs. Device is in production to support existing customers, but TI does not recommend using this part in a new design.

PREVIEW: Device has been announced but is not in production. Samples may or may not be available.

OBSELETE: TI has discontinued the production of the device.

(2) **RoHS:** TI defines "RoHS" to mean semiconductor products that are compliant with the current EU RoHS requirements for all 10 RoHS substances, including the requirement that RoHS substance do not exceed 0.1% by weight in homogeneous materials. Where designed to be soldered at high temperatures, "RoHS" products are suitable for use in specified lead-free processes. TI may reference these types of products as "Pb-Free".

RoHS Exempt: TI defines "RoHS Exempt" to mean products that contain lead but are compliant with EU RoHS pursuant to a specific EU RoHS exemption.

Green: TI defines "Green" to mean the content of Chlorine (Cl) and Bromine (Br) based flame retardants meet JS709B low halogen requirements of <=1000ppm threshold. Antimony trioxide based flame retardants must also meet the <=1000ppm threshold requirement.

(3) MSL, Peak Temp. - The Moisture Sensitivity Level rating according to the JEDEC industry standard classifications, and peak solder temperature.

(4) There may be additional marking, which relates to the logo, the lot trace code information, or the environmental category on the device.

(5) Multiple Device Markings will be inside parentheses. Only one Device Marking contained in parentheses and separated by a "-" will appear on a device. If a line is indented then it is a continuation of the previous line and the two combined represent the entire Device Marking for that device.

(6) Lead finish/Ball material - Orderable Devices may have multiple material finish options. Finish options are separated by a vertical ruled line. Lead finish/Ball material values may wrap to two lines if the finish value exceeds the maximum column width.

Important Information and Disclaimer:The information provided on this page represents TI's knowledge and belief as of the date that it is provided. TI bases its knowledge and belief on information provided by third parties, and makes no representation or warranty as to the accuracy of such information. Efforts are underway to better integrate information from third parties. TI has taken and

continues to take reasonable steps to provide representative and accurate information but may not have conducted destructive testing or chemical analysis on incoming materials and chemicals. TI and TI suppliers consider certain information to be proprietary, and thus CAS numbers and other limited information may not be available for release.

In no event shall TI's liability arising out of such information exceed the total purchase price of the TI part(s) at issue in this document sold by TI to Customer on an annual basis.

OTHER QUALIFIED VERSIONS OF TPS22953-Q1, TPS22954-Q1 :

- Catalog : [TPS22953](#), [TPS22954](#)

NOTE: Qualified Version Definitions:

- Catalog - TI's standard catalog product

TAPE AND REEL INFORMATION

QUADRANT ASSIGNMENTS FOR PIN 1 ORIENTATION IN TAPE

*All dimensions are nominal

Device	Package Type	Package Drawing	Pins	SPQ	Reel Diameter (mm)	Reel Width W1 (mm)	A0 (mm)	B0 (mm)	K0 (mm)	P1 (mm)	W (mm)	Pin1 Quadrant
TPS22953QDQCRQ1	WS0N	DQC	10	3000	180.0	8.4	2.25	3.25	1.05	4.0	8.0	Q1
TPS22954QDQCRQ1	WS0N	DQC	10	3000	180.0	8.4	2.25	3.25	1.05	4.0	8.0	Q1

TAPE AND REEL BOX DIMENSIONS

*All dimensions are nominal

Device	Package Type	Package Drawing	Pins	SPQ	Length (mm)	Width (mm)	Height (mm)
TPS22953QDQCRQ1	WSON	DQC	10	3000	210.0	185.0	35.0
TPS22954QDQCRQ1	WSON	DQC	10	3000	210.0	185.0	35.0

GENERIC PACKAGE VIEW

DQC 10

WSON - 0.8 mm max height

PLASTIC SMALL OUTLINE - NO LEAD

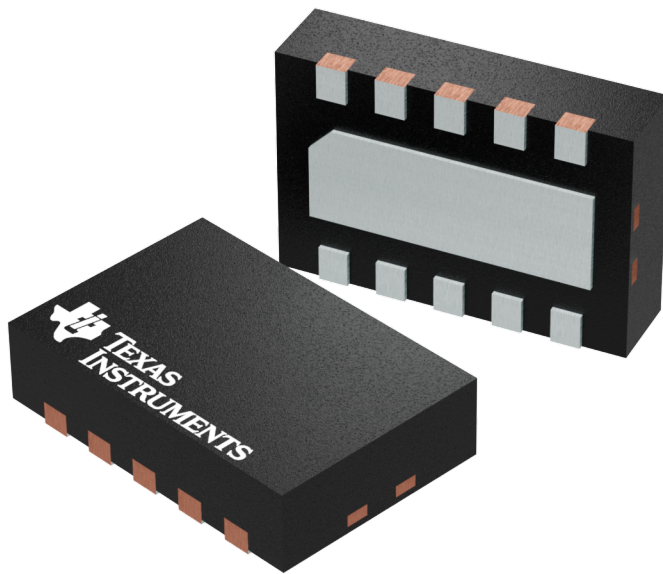

Images above are just a representation of the package family, actual package may vary.
Refer to the product data sheet for package details.

4209674/B

DQC0010A



PACKAGE OUTLINE

WSO - 0.8mm max height

PLASTIC SMALL OUTLINE - NO LEAD

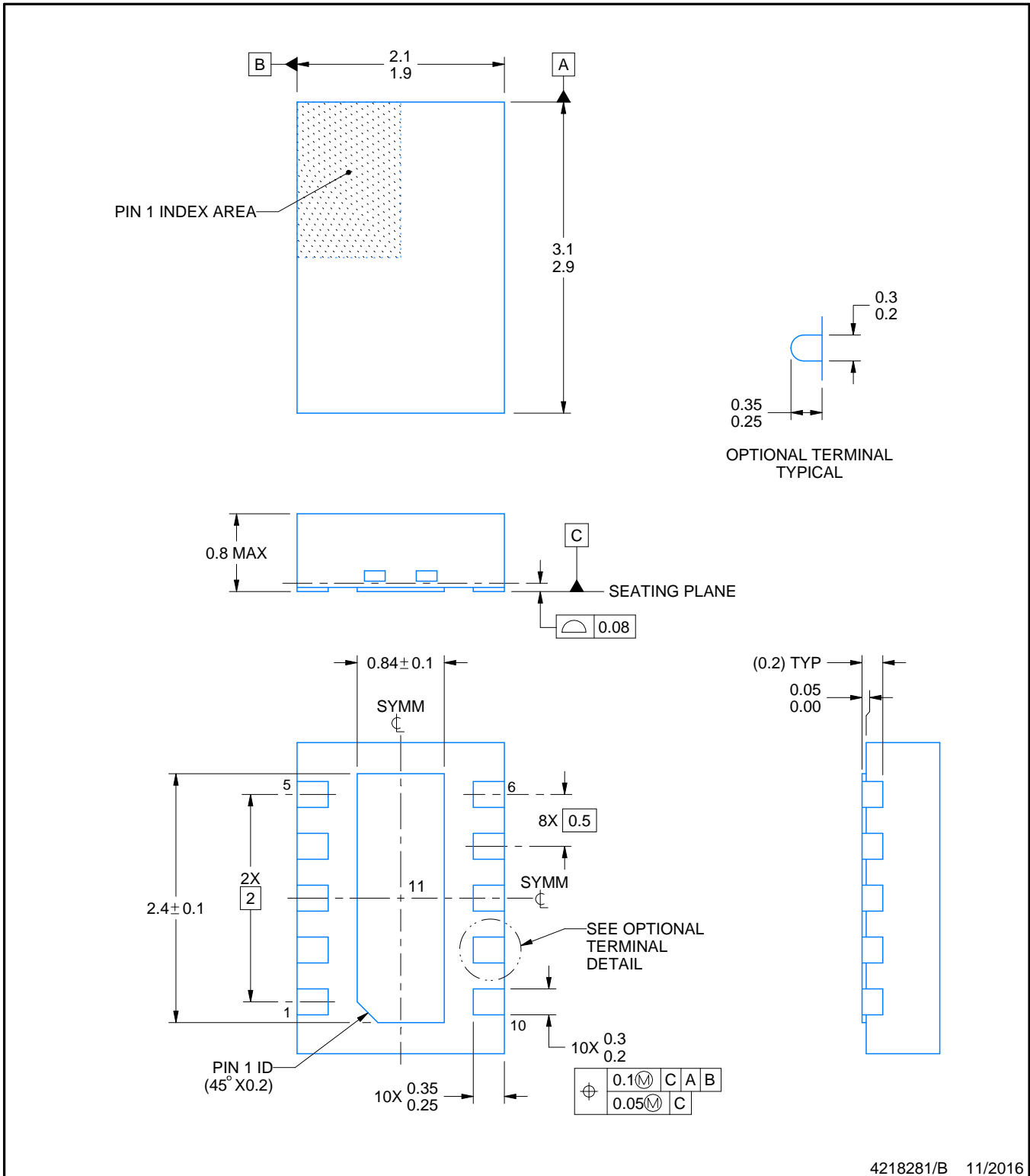

4218281/B 11/2016

NOTES:

1. All linear dimensions are in millimeters. Any dimensions in parenthesis are for reference only. Dimensioning and tolerancing per ASME Y14.5M.
2. This drawing is subject to change without notice.
3. The package thermal pad must be soldered to the printed circuit board for thermal and mechanical performance.

EXAMPLE BOARD LAYOUT

DQC0010A

WSO - 0.8mm max height

PLASTIC SMALL OUTLINE - NO LEAD

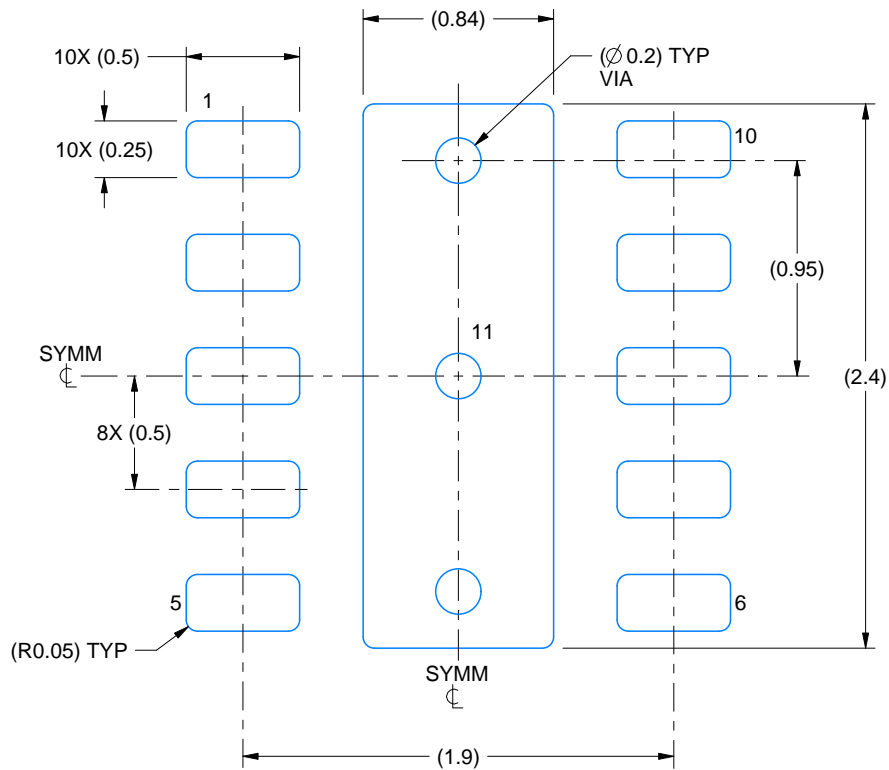

LAND PATTERN EXAMPLE
SCALE: 30X

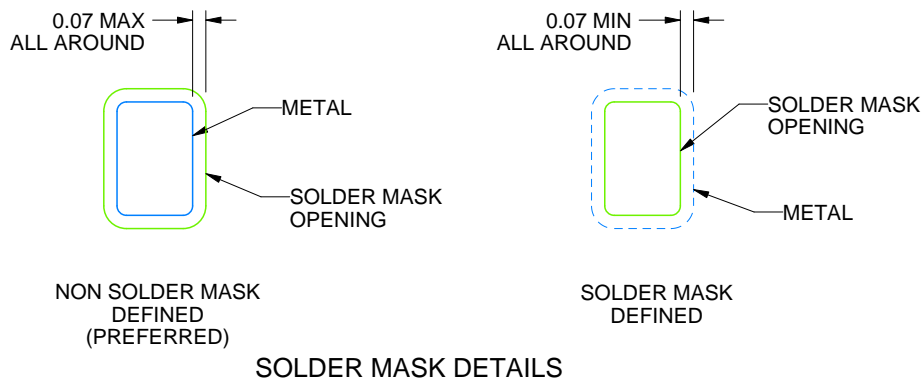

4218281/B 11/2016

NOTES: (continued)

4. This package is designed to be soldered to a thermal pad on the board. For more information, see Texas Instruments literature number SLUA271 (www.ti.com/lit/slue271).
5. Vias are optional depending on application, refer to device data sheet. If any vias are implemented, refer to their locations shown on this view. It is recommended that vias under paste be filled, plugged or tented.

EXAMPLE STENCIL DESIGN

DQC0010A

WSN - 0.8mm max height

PLASTIC SMALL OUTLINE - NO LEAD

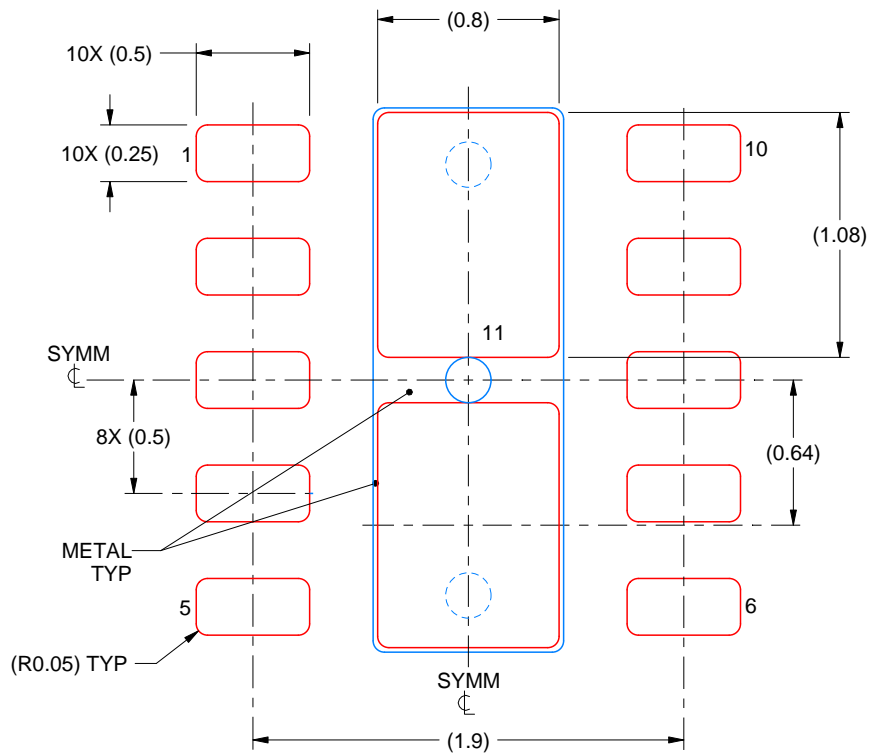

SOLDER PASTE EXAMPLE
BASED ON 0.125 mm THICK STENCIL

EXPOSED PAD 11:
86% PRINTED SOLDER COVERAGE BY AREA UNDER PACKAGE
SCALE: 30X

4218281/B 11/2016

NOTES: (continued)

6. Laser cutting apertures with trapezoidal walls and rounded corners may offer better paste release. IPC-7525 may have alternate design recommendations.

IMPORTANT NOTICE AND DISCLAIMER

TI PROVIDES TECHNICAL AND RELIABILITY DATA (INCLUDING DATA SHEETS), DESIGN RESOURCES (INCLUDING REFERENCE DESIGNS), APPLICATION OR OTHER DESIGN ADVICE, WEB TOOLS, SAFETY INFORMATION, AND OTHER RESOURCES "AS IS" AND WITH ALL FAULTS, AND DISCLAIMS ALL WARRANTIES, EXPRESS AND IMPLIED, INCLUDING WITHOUT LIMITATION ANY IMPLIED WARRANTIES OF MERCHANTABILITY, FITNESS FOR A PARTICULAR PURPOSE OR NON-INFRINGEMENT OF THIRD PARTY INTELLECTUAL PROPERTY RIGHTS.

These resources are intended for skilled developers designing with TI products. You are solely responsible for (1) selecting the appropriate TI products for your application, (2) designing, validating and testing your application, and (3) ensuring your application meets applicable standards, and any other safety, security, regulatory or other requirements.

These resources are subject to change without notice. TI grants you permission to use these resources only for development of an application that uses the TI products described in the resource. Other reproduction and display of these resources is prohibited. No license is granted to any other TI intellectual property right or to any third party intellectual property right. TI disclaims responsibility for, and you will fully indemnify TI and its representatives against, any claims, damages, costs, losses, and liabilities arising out of your use of these resources.

TI's products are provided subject to [TI's Terms of Sale](#) or other applicable terms available either on ti.com or provided in conjunction with such TI products. TI's provision of these resources does not expand or otherwise alter TI's applicable warranties or warranty disclaimers for TI products.

TI objects to and rejects any additional or different terms you may have proposed.

Mailing Address: Texas Instruments, Post Office Box 655303, Dallas, Texas 75265
Copyright © 2022, Texas Instruments Incorporated