

DUAL HOT-SWAP POWER CONTROLLERS WITH INTERDEPENDENT CIRCUIT BREAKER AND POWER-GOOD REPORTING

Check for Samples: [TPS2310](#), [TPS2311](#)

FEATURES

- Dual-Channel High-Side MOSFET Drivers
- IN1: 3 V to 13 V; IN2: 3 V to 5.5 V
- Output dV/dt Control Limits Inrush Current
- Circuit-Breaker With Programmable Overcurrent Threshold and Transient Timer
- Power-Good Reporting With Transient Filter
- CMOS- and TTL-Compatible Enable Input
- Low, 5- μ A Standby Supply Current (Max)
- Available in 20-Pin TSSOP Package
- -40°C to 85°C Ambient Temperature Range
- Electrostatic Discharge Protection

APPLICATIONS

- Hot-Swap/Plug/Dock Power Management
- Hot-Plug PCI, Device Bay
- Electronic Circuit Breaker

DESCRIPTION

The TPS2310 and TPS2311 are dual-channel hot-swap controllers that use external N-channel MOSFETs as high-side switches in power applications. Features of these devices, such as overcurrent protection (OCP), inrush current control, output-power status reporting, and the ability to discriminate between load transients and faults, are critical requirements for hot-swap applications.

The TPS2310/11 devices incorporate undervoltage lockout (UVLO) and power-good (PG) reporting to ensure the device is off at start-up and confirm the status of the output voltage rails during operation. Each internal charge pump, capable of driving multiple MOSFETs, provides enough gate-drive voltage to fully enhance the N-channel MOSFETs. The charge pumps control both the rise times and fall times (dv/dt) of the MOSFETs, reducing power transients during power up/down. The circuit-breaker functionality combines the ability to sense overcurrent conditions with a timer function; this allows designs such as DSPs, that may have high peak currents during power-state transitions, to disregard transients for a programmable period.

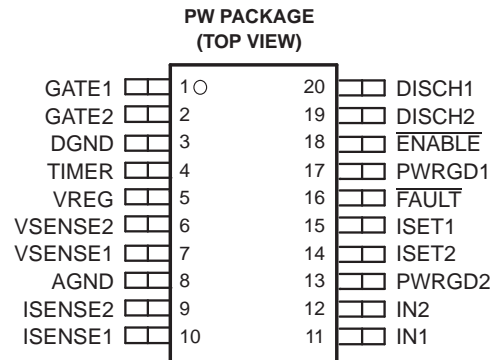

NOTE: Terminal 18 is active high on TPS2311.

typical application

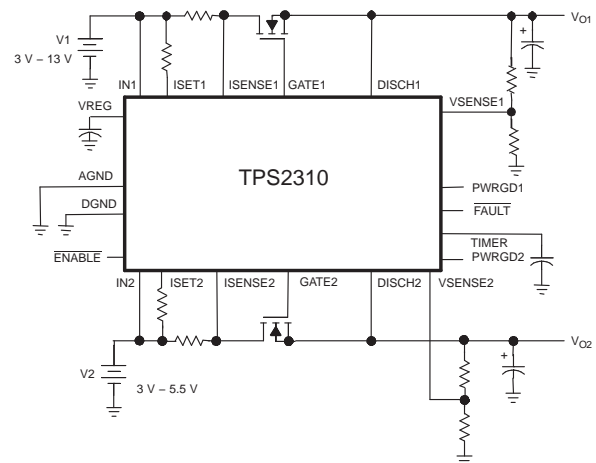

Please be aware that an important notice concerning availability, standard warranty, and use in critical applications of Texas Instruments semiconductor products and disclaimers thereto appears at the end of this data sheet.

Table 1. AVAILABLE OPTIONS⁽¹⁾

T _A	HOT-SWAP CONTROLLER DESCRIPTION	PIN COUNT	TSSOP PACKAGES (PW, PWR) ⁽²⁾	
			ENABLE	ENABLE
-40°C to 85°C	Dual-channel with independent OCP and adjustable PG	20	TPS2300IPW	TPS2301IPW
	Dual-channel with interdependent OCP and adjustable PG	20	TPS2310IPW	TPS2311IPW
	Dual-channel with independent OCP	16	TPS2320IPW	TPS2321IPW
	Single-channel with OCP and adjustable PG	14	TPS2330IPW	TPS2331IPW

- (1) For the most current package and ordering information, see the Package Option Addendum at the end of this document, or see the TI website at www.ti.com.
 (2) The packages are available left-end taped and reeled (indicated by the R suffix on the device type; e.g., TPS2311IPWR).

FUNCTIONAL BLOCK DIAGRAM

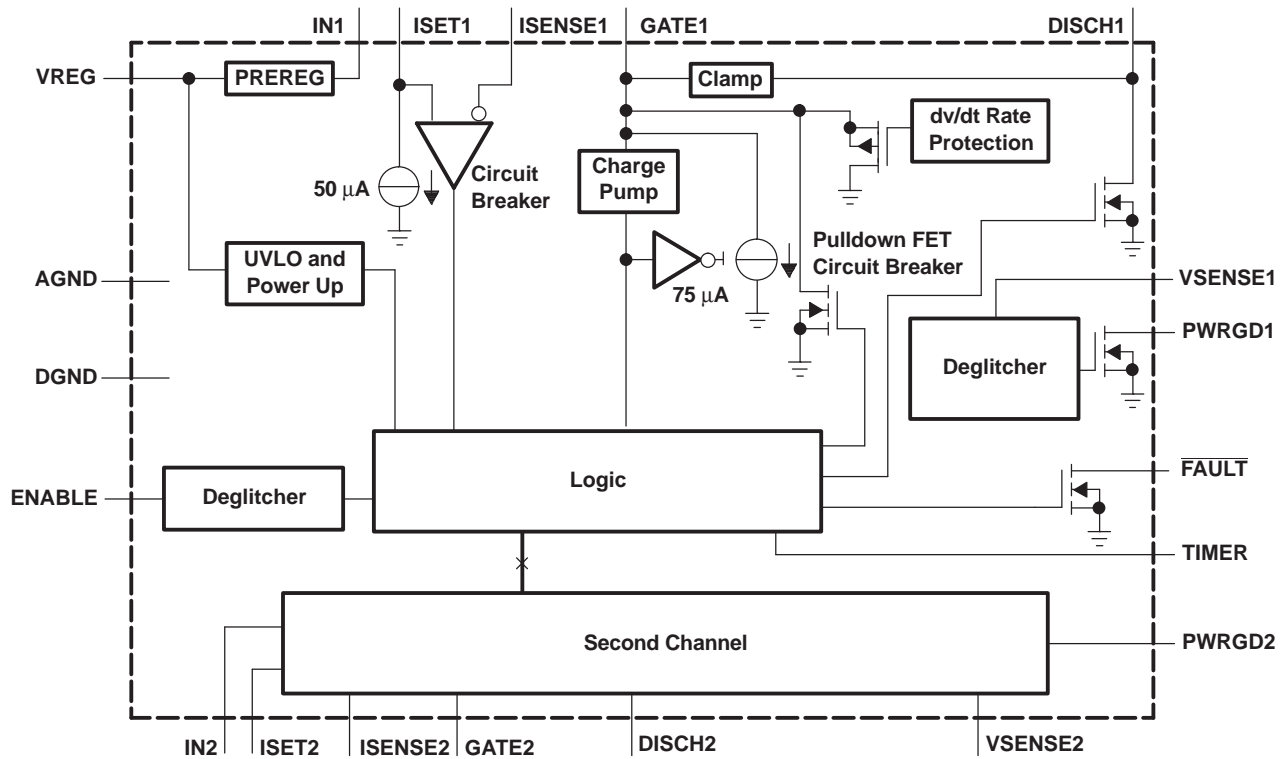

Table 2. Terminal Functions

TERMINAL NAME	NO.	I/O	DESCRIPTION
AGND	8	I	Analog ground, connects to DGND as close as possible
DGND	3	I	Digital ground
DISCH1	20	O	Discharge transistor 1
DISCH2	19	O	Discharge transistor 2
ENABLE/ ENABLE	18	I	Active low (TPS2310) or active high enable (TPS2311)
FAULT	16	O	Overcurrent fault, open-drain output
GATE1	1	O	Connects to gate of channel 1 high-side MOSFET
GATE2	2	O	Connects to gate of channel 2 high-side MOSFET
IN1	11	I	Input voltage for channel 1
IN2	12	I	Input voltage for channel 2
ISENSE1	10	I	Current-sense input channel 1
ISENSE2	9	I	Current-sense input channel 2

Table 2. Terminal Functions (continued)

TERMINAL NAME	NO.	I/O	DESCRIPTION
ISET1	15	I	Adjusts circuit-breaker threshold with resistor connected to IN1
ISET2	14	I	Adjusts circuit-breaker threshold with resistor connected to IN2
PWRGD1	17	O	Open-drain output, asserted low when VSENSE1 voltage is less than reference.
PWRGD2	13	O	Open-drain output, asserted low when VSENSE2 voltage is less than reference.
TIMER	4	O	Adjusts circuit-breaker deglitch time
VREG	5	O	Connects to bypass capacitor, for stable operation
VSENSE1	7	I	Power-good sense input channel 1
VSENSE2	6	I	Power-good sense input channel 2

DETAILED DESCRIPTION

DISCH1, DISCH2 – DISCH1 and DISCH2 should be connected to the sources of the external N-channel MOSFET transistors connected to GATE1 and GATE2, respectively. These pins discharge the loads when the MOSFET transistors are disabled. They also serve as reference-voltage connections for internal gate voltage-clamp circuitry.

ENABLE or ENABLER – $\overline{\text{ENABLE}}$ for TPS2310 is active-low. ENABLE for TPS2311 is active-high. When the controller is enabled, both GATE1 and GATE2 voltages will power up to turn on the external MOSFETs. When the $\overline{\text{ENABLE}}$ pin is pulled high for TPS2310 or the ENABLER pin is pulled low for TPS2311 for more than 50 μs , the gate of the MOSFET is discharged at a controlled rate by a current source, and a transistor is enabled to discharge the output bulk capacitance. In addition, the device turns on the internal regulator PREREG (see VREG) when enabled and shuts down PREREG when disabled so that total supply current is less than 5 μA .

FAULT – FAULT is an open-drain overcurrent flag output. When an overcurrent condition in either channel is sustained long enough to charge TIMER to 0.5 V, both channels latch off and pull this pin low. In order to turn the device back on, either the enable pin has to be toggled or the input power has to be cycled.

GATE1, GATE2 – GATE1 and GATE2 connect to the gates of external N-channel MOSFET transistors. When the device is enabled, internal charge-pump circuitry pulls these pins up by sourcing approximately 15 μA to each. The turnon slew rates depend upon the capacitance present at the GATE1 and GATE2 terminals. If desired, the turnon slew rates can be further reduced by connecting capacitors between these pins and ground. These capacitors also reduce inrush current and protect the device from false overcurrent triggering during powerup. The charge-pump circuitry generates gate-to-source voltages of 9 V–12 V across the external MOSFET transistors.

IN1, IN2 – IN1 and IN2 should be connected to the power sources driving the external N-channel MOSFET transistors connected to GATE1 and GATE2, respectively. The TPS2310/TPS2311 draws its operating current from IN1, and both channels remains disabled until the IN1 power supply has been established. The IN1 channel has been constructed to support 3-V, 5-V, or 12-V operation, while the IN2 channel has been constructed to support 3-V or 5-V operation

ISENSE1, ISENSE2, ISET1, ISET2 – ISENSE1 and ISENSE2, in combination with ISET1 and ISET2, implement overcurrent sensing for GATE1 and GATE2. ISET1 and ISET2 set the magnitude of the current that generates an overcurrent fault, through external resistors connected to ISET1 and ISET2. An internal current source draws 50 μA from ISET1 and ISET2. With a sense resistor from IN1 to ISENSE1 or from IN2 to ISENSE2, which is also connected to the drains of external MOSFETs, the voltage on the sense resistor reflects the load current. An overcurrent condition is assumed to exist if ISENSE1 is pulled below ISET1 or if ISENSE2 is pulled below ISET2. To ensure proper circuit breaker operation, $V_{I(\text{ISENSE1})}$ and $V_{I(\text{ISENSE2})}$ should never exceed $V_{I(\text{IN1})}$. Similarly, $V_{I(\text{ISENSE2})}$ and $V_{I(\text{ISENSE1})}$ should never exceed $V_{I(\text{IN2})}$.

PWRGD1, PWRGD2 – PWRGD1 and PWRGD2 signal the presence of undervoltage conditions on VSENSE1 and VSENSE2, respectively. These pins are open-drain outputs and are pulled low during an undervoltage condition. To minimize erroneous PWRGDx responses from transients on the voltage rail, the voltage sense circuit incorporates a 20- μ s deglitch filter. When VSENSEx is lower than the reference voltage (about 1.23 V), PWRGDx is active low to indicate an undervoltage condition on the power-rail voltage. PWRGDx may not correctly report power conditions when the device is disabled, because there is no gate drive power for the PWRGD output transistor in the disable mode, or, in other words, PWRGD is floating. Therefore, PWRGD is pulled up to its pullup power supply rail in disable mode.

TIMER – A capacitor on TIMER sets the time during which the power switch can be in overcurrent before turning off. When the overcurrent protection circuits sense an excessive current, a current source is enabled which charges the capacitor on TIMER. Once the voltage on TIMER reaches approximately 0.5 V, the circuit-breaker latch is set and the power switch is latched off. Power must be recycled or the ENABLE pin must be toggled to restart the controller. In high-power or high-temperature applications, a minimum 50-pF capacitor is strongly recommended from TIMER to ground, to prevent any false triggering.

VREG – VREG is the output of an internal low-dropout voltage regulator, where IN1 is the input. The regulator is used to generate a regulated voltage source, less than 5.5 V, for the device. A 0.1- μ F ceramic capacitor should be connected between VREG and ground to aid in noise rejection. In this configuration, upon disabling the device, the internal low-dropout regulator will also be disabled, which removes power from the internal circuitry and allows the device to be placed in low-quiescent-current mode. In applications where IN1 is less than 5.5 V, VREG and IN1 may be connected together. However, under these conditions, disabling the device does not place the device in low-quiescent-current mode, because the internal low-dropout voltage regulator is being bypassed, thereby keeping internal circuitry operational. If VREG and IN1 are connected together, a 0.1- μ F ceramic capacitor between VREG and ground is not needed if IN1 already has a bypass capacitor of 1 μ F to 10 μ F.

VSENSE1, VSENSE2 – VSENSE1 and VSENSE2 can be used to detect undervoltage conditions on external circuitry. If VSENSE1 senses a voltage below approximately 1.23 V, PWRGD1 is pulled low. Similarly, a voltage less than 1.23 V on VSENSE2 causes PWRGD2 to be pulled low.

ABSOLUTE MAXIMUM RATINGS

over operating free-air temperature range (unless otherwise noted) ⁽¹⁾ ⁽²⁾

		VALUE	UNIT
Input voltage range	$V_{I(IN1)}, V_{I(ISENSE1)}, V_{I(VSENSE1)}, V_{I(VSENSE2)}, V_{I(ISET1)}, V_{I(ENABLE)}, V_{I(VREG)}$	-0.3 to 15	V
	$V_{I(IN2)}, V_{I(ISENSE2)}, V_{I(ISET2)}$	-0.3 to 7	V
Output voltage range	$V_{O(GATE1)}$	-0.3 to 30	V
	$V_{O(GATE2)}$	-0.3 to 22	V
	$V_{O(DISCH1)}, V_{O(PWRGD1)}, V_{O(PWRGD2)}, V_{O(FAULT)}, V_{O(DISCH2)}, V_{O(TIMER)}$	-0.3 to 15	V
Sink current range	$I_{(GATE1)}, I_{(GATE2)}, I_{(DISCH1)}, I_{(DISCH2)}$	0 to 100	mA
	$I_{(PWRGD1)}, I_{(PWRGD2)}, I_{(TIMER)}, I_{(FAULT)}$	0 to 10	mA
Operating virtual junction temperature range, T_J		-40 to 100	°C
Storage temperature range, T_{stg}		-55 to 150	°C
Lead temperature 1,6 mm (1/16 inch) from case for 10 seconds		260	°C

- (1) Stresses beyond those listed under *absolute maximum ratings* may cause permanent damage to the device. These are stress ratings only, and functional operation of the device at these or any other conditions beyond those indicated under *recommended operating conditions* is not implied. Exposure to absolute-maximum-rated conditions for extended periods may affect device reliability.
- (2) All voltages are respect to DGND.

DISSIPATION RATING TABLE

PACKAGE	$T_A \leq 25^\circ\text{C}$ POWER RATING	DERATING FACTOR ABOVE $T_A = 25^\circ\text{C}$	$T_A = 70^\circ\text{C}$ POWER RATING	$T_A = 85^\circ\text{C}$ POWER RATING
PW-20	1015 mW	13.55 mW/°C	406 mW	203 mW

RECOMMENDED OPERATING CONDITIONS

		MIN	NOM	MAX	UNIT	
V _I	Input voltage	V _{I(IN1)} , V _{I(ISENSE1)} , V _{I(VSENSE1)} , V _{I(VSENSE2)} , V _{I(ISET1)}		3	13	V
		V _{I(IN2)} , V _{I(ISENSE2)} , V _{I(ISET2)} , V _{I(VREG)}		3	5.5	
		V _{I(ISENSE1)} , V _{I(ISET1)} , V _{I(VSENSE1)}		V _{I(IN1)}		
		V _{I(ISENSE2)} , V _{I(ISET2)} , V _{I(VSENSE2)}		V _{I(IN2)}		
T _J	Operating virtual junction temperature	-40		100	°C	

ELECTRICAL CHARACTERISTICS

over recommended operating temperature range (-40°C < T_A < 85°C), 3 V ≤ V_{I(IN1)} ≤ 13 V, 3 V ≤ V_{I(IN2)} ≤ 5.5 V (unless otherwise noted)

PARAMETER		TEST CONDITIONS		MIN	TYP	MAX	UNIT
GENERAL							
I _{I(IN1)}	Input current, IN1	V _{I(ENABLE)} = 5 V (TPS2311),			0.5	1	mA
I _{I(IN2)}	Input current, IN2	V _{I(ENABLE)} = 0 V (TPS2310)			75	200	μA
I _{I(stby)}	Standby current (sum of currents into IN1, IN2, ISENSE1, ISENSE2, ISET1, and ISET2)	V _{I(ENABLE)} = 0 V (TPS2311), V _{I(ENABLE)} = 5 V (TPS2310)				5	μA
GATE1							
V _{G(GATE1_3V)}	Gate voltage	I _{I(GATE1)} = 500 nA, DISCH1 open	V _{I(IN1)} = 3 V	9	11.5		V
V _{G(GATE1_4.5V)}			V _{I(IN1)} = 4.5 V	10.5	14.5		
V _{G(GATE1_10.8V)}			V _{I(IN1)} = 10.8 V	16.8	21		
V _{C(GATE1)}	Clamping voltage, GATE1 to DISCH1			9	10	12	V
I _{S(GATE1)}	Source current, GATE1	3 V ≤ V _{I(IN1)} ≤ 13.2 V, 3 V ≤ V _{O(VREG)} ≤ 5.5 V, V _{I(GATE1)} = V _{I(IN1)} + 6 V		10	14	20	μA
	Sink current, GATE1	3 V ≤ V _{I(IN1)} ≤ 13.2 V, 3 V ≤ V _{O(VREG)} ≤ 5.5 V, V _{I(GATE1)} = V _{I(IN1)}		50	75	100	μA
t _{r(GATE1)}	Rise time, GATE1	C _g to GND = 1 nF ⁽¹⁾	V _{I(IN1)} = 3 V	0.5			ms
			V _{I(IN1)} = 4.5 V	0.6			
			V _{I(IN1)} = 10.8 V	1			
t _{f(GATE1)}	Fall time, GATE1	C _g to GND = 1 nF ⁽¹⁾	V _{I(IN1)} = 3 V	0.1			ms
			V _{I(IN1)} = 4.5 V	0.12			
			V _{I(IN1)} = 10.8 V	0.2			
GATE2							
V _{G(GATE2_3V)}	Gate voltage	I _{I(GATE2)} = 500 nA, DISCH2 open	V _{I(IN2)} = 3 V	9	11.7		V
V _{G(GATE2_4.5V)}			V _{I(IN2)} = 4.5 V	10.5	14.7		
V _{C(GATE2)}	Clamping voltage, GATE2 to DISCH2			9	10	12	V
I _{S(GATE2)}	Source current, GATE2	3 V ≤ V _{I(IN2)} ≤ 5.5 V, 3 V ≤ V _{O(VREG)} ≤ 5.5 V, V _{I(GATE2)} = V _{I(IN2)} + 6 V		10	14	20	μA
	Sink current, GATE2	3 V ≤ V _{I(IN2)} ≤ 5.5 V, 3 V ≤ V _{O(VREG)} ≤ 5.5 V, V _{I(GATE2)} = V _{I(IN2)}		50	75	100	μA
t _{r(GATE2)}	Rise time, GATE2	C _g to GND = 1 nF ⁽¹⁾	V _{I(IN2)} = 3 V	0.5			ms
			V _{I(IN2)} = 4.5 V	0.6			
t _{f(GATE2)}	Fall time, GATE2	C _g to GND = 1 nF ⁽¹⁾	V _{I(IN2)} = 3 V	0.1			ms
			V _{I(IN2)} = 4.5 V	0.12			

(1) Specified, but not production tested.

ELECTRICAL CHARACTERISTICS (Continued)

over recommended operating temperature range ($-40^{\circ}\text{C} < T_A < 85^{\circ}\text{C}$), $3\text{ V} \leq V_{I(IN1)} \leq 13\text{ V}$, $3\text{ V} \leq V_{I(IN2)} \leq 5.5\text{ V}$ (unless otherwise noted)

PARAMETER		TEST CONDITIONS	MIN	TYP	MAX	UNIT
TIMER						
$V_{(TO_TIMER)}$	Threshold voltage, TIMER		0.4	0.5	0.6	V
	Charge current, TIMER	$V_{I(TIMER)} = 0\text{ V}$	35	50	65	μA
	Discharge current, TIMER	$V_{I(TIMER)} = 1\text{ V}$	1	2.5		mA
CIRCUIT BREAKER						
$V_{IT(CB)}$	Threshold voltage, circuit breaker	$R_{ISETx} = 1\text{ k}\Omega$	40	50	60	mV
		$R_{ISETx} = 400\ \Omega$, $T_A = 25^{\circ}\text{C}$	14	19	24	
		$R_{ISETx} = 1\text{ k}\Omega$, $T_A = 25^{\circ}\text{C}$	44	50	53	
		$R_{ISETx} = 1.5\text{ k}\Omega$, $T_A = 25^{\circ}\text{C}$	68	73	78	
$I_{(IB_ISENSEx)}$	Input bias current, I_{SENSEx}		0.1	5	μA	
	Discharge current, $GATEx$	$V_{O(GATEx)} = 4\text{ V}$	400	800		mA
		$V_{O(GATEx)} = 1\text{ V}$	25	150		
$t_{pd(CB)}$	Propagation (delay) time, comparator inputs to gate output	$C_g = 50\text{ pF}$, (50% to 10%), $C_{TIMER} = 50\text{ pF}$		1.3		μs
ENABLE, ACTIVE LOW (TPS2310)						
$V_{IH(ENABLE)}$	High-level input voltage, <u>ENABLE</u>		2			V
$V_{IL(ENABLE)}$	Low-level input voltage, <u>ENABLE</u>				0.8	V
$R_{I(ENABLE)}$	Input pullup resistance, <u>ENABLE</u>	See (1)	100	200	300	$\text{k}\Omega$
$t_{d(off_ENABLE)}$	Turnoff delay time, <u>ENABLE</u>	$V_{I(ENABLE)}$ increasing above stop threshold; 100 ns rise time, 20 mV overdrive ⁽²⁾		60		μs
$t_{d(on_ENABLE)}$	Turnon delay time, <u>ENABLE</u>	$V_{I(ENABLE)}$ decreasing below start threshold; 100 ns fall time, 20 mV overdrive ⁽²⁾		125		μs
ENABLE, ACTIVE HIGH (TPS2311)						
$V_{IH(ENABLE)}$	High-level input voltage, <u>ENABLE</u>		2			V
$V_{IL(ENABLE)}$	Low-level input voltage, <u>ENABLE</u>				0.7	V
$R_{I(ENABLE)}$	Input pulldown resistance, <u>ENABLE</u>		100	150	300	$\text{k}\Omega$
$t_{d(on_ENABLE)}$	Turnon delay time, <u>ENABLE</u>	$V_{I(ENABLE)}$ increasing above start threshold; 100 ns rise time, 20 mV overdrive ⁽²⁾		85		μs
$t_{d(off_ENABLE)}$	Turnoff delay time, <u>ENABLE</u>	$V_{I(ENABLE)}$ decreasing below stop threshold; 100 ns fall time, 20 mV overdrive ⁽²⁾		100		μs
PREREG						
$V_{(VREG)}$	PREREG output voltage	$4.5 \leq V_{I(IN1)} \leq 13\text{ V}$	3.5	4.1	5.5	V
$V_{(drop_PREREG)}$	PREREG dropout voltage	$V_{I(IN1)} = 3\text{ V}$			0.1	V

- (1) Test I_O of ENABLE at $V_{I(ENABLE)} = 1\text{ V}$ and 0 V , then $R_{I(ENABLE)} = \frac{1\text{ V}}{I_{O_0V} - I_{O_1V}}$
(2) Specified, but not production tested.

ELECTRICAL CHARACTERISTICS (Continued)

 over recommended operating temperature range ($-40^{\circ}\text{C} < T_A < 85^{\circ}\text{C}$), $3\text{ V} \leq V_{I(IN1)} \leq 13\text{ V}$, $3\text{ V} \leq V_{I(IN2)} \leq 5.5\text{ V}$ (unless otherwise noted)

PARAMETER		TEST CONDITIONS	MIN	TYP	MAX	UNIT
VREG UVLO						
$V_{(TO_UVLOstart)}$	Output threshold voltage, start		2.75	2.85	2.95	V
$V_{(TO_UVLOstop)}$	Output threshold voltage, stop		2.65	2.78		V
$V_{hys(UVLO)}$	Hysteresis		50	75		mV
	UVLO sink current, GATE _x	$V_{I(GATEx)} = 2\text{ V}$	10			mA
PWRGD1 and PWRGD2						
$V_{IT(ISENSEx)}$	Trip threshold, VSENSE _x	$V_{I(VSENSEx)}$ decreasing	1.2	1.225	1.25	V
V_{hys}	Hysteresis voltage, power-good comparator		20	30	40	mV
$V_{O(sat_PWRGDx)}$	Output saturation voltage, PWRGD _x	$I_O = 2\text{ mA}$		0.2	0.4	V
$V_{O(VREG_min)}$	Minimum $V_{O(VREG)}$ for valid power-good	$I_O = 100\text{ }\mu\text{A}$, $V_{O(PWRGDx)} = 1\text{ V}$			1	V
	Input bias current, power-good comparator	$V_{I(VSENSEx)} = 5.5\text{ V}$			1	μA
$I_{lkg(PWRGDx)}$	Leakage current, PWRGD _x	$V_{O(PWRGDx)} = 13\text{ V}$			1	μA
t_{dr}	Delay time, rising edge, PWRGD _x	$V_{I(VSENSEx)}$ increasing, overdrive = 20 mV, $t_r = 100\text{ ns}$ ⁽¹⁾		25		μs
t_{df}	Delay time, falling edge, PWRGD _x	$V_{I(VSENSEx)}$ decreasing, overdrive = 20 mV, $t_r = 100\text{ ns}$ ⁽¹⁾		2		μs
FAULT OUTPUT						
$V_{O(sat_FAULT)}$	Output saturation voltage, FAULT	$I_O = 2\text{ mA}$			0.4	V
$I_{lkg(FAULT)}$	Leakage current, $\overline{\text{FAULT}}$	$V_{O(FAULT)} = 13\text{ V}$			1	μA
DISCH1 AND DISCH2						
$I_{(DISCH)}$	Discharge current, DISCH _x	$V_{I(DISCHx)} = 1.5\text{ V}$, $V_{I(VIN1)} = 5\text{ V}$	5	10		mA
$V_{IH(DISCH)}$	Discharge on high-level input voltage		2			V
$V_{IL(DISCH)}$	Discharge on low-level input voltage				1	V

(1) Specified, but not production tested.

PARAMETER MEASUREMENT INFORMATION

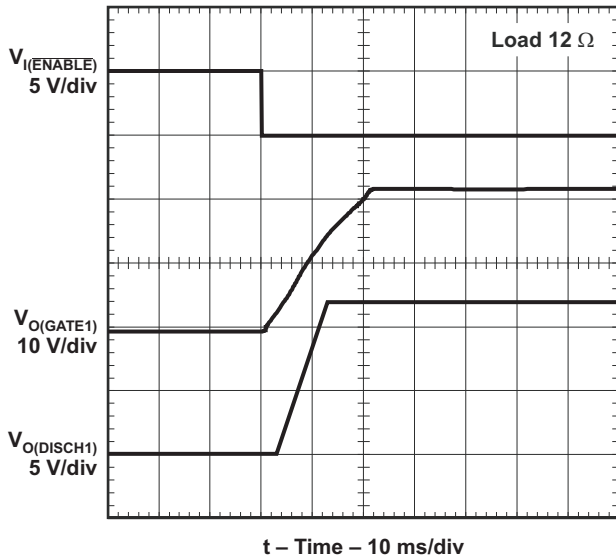

Figure 1. Turnon Voltage Transition of Channel 1

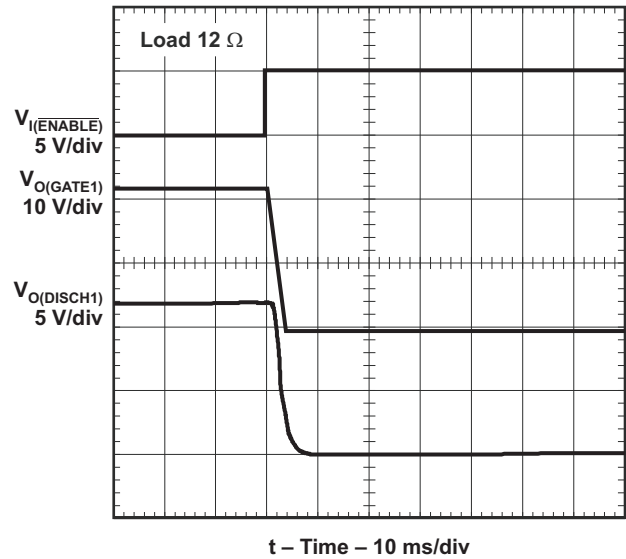

Figure 2. Turnoff Voltage Transition of Channel 1

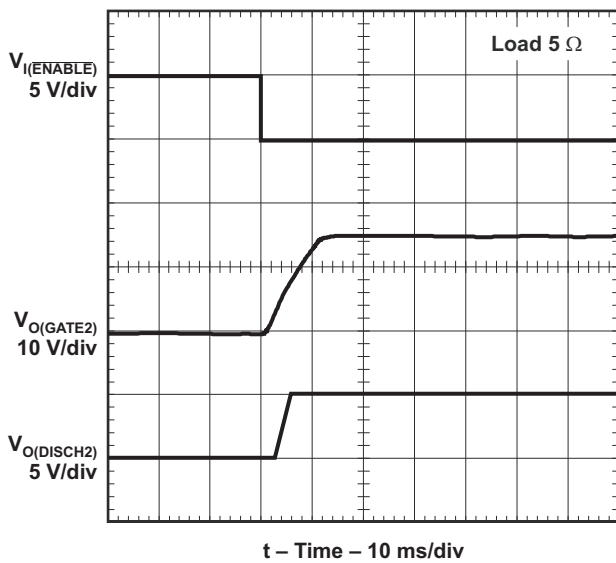

Figure 3. Turnon Voltage Transition of Channel 2

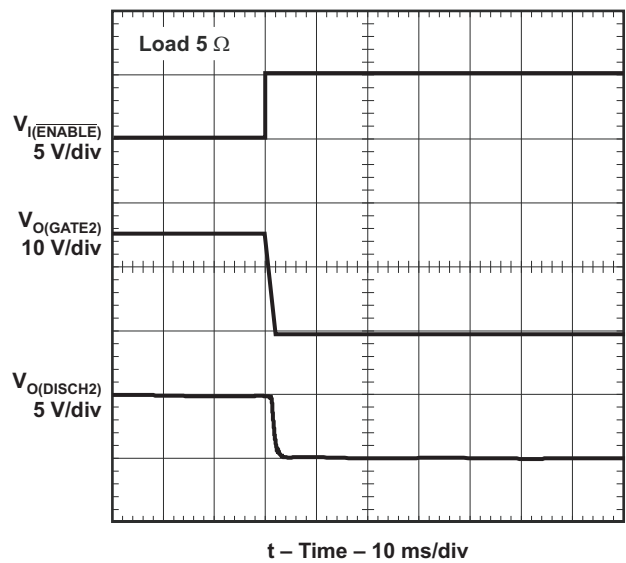

Figure 4. Turnoff Voltage Transition of Channel 2

PARAMETER MEASUREMENT INFORMATION (continued)

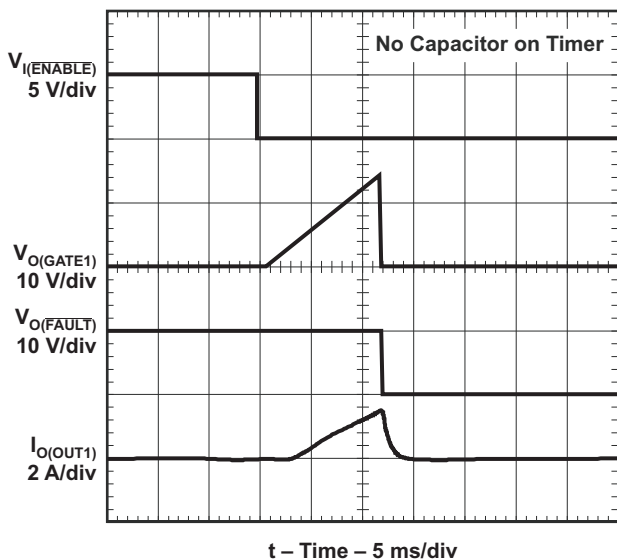

Figure 5. Channel 1 Overcurrent Response: Enabled Into Overcurrent Load

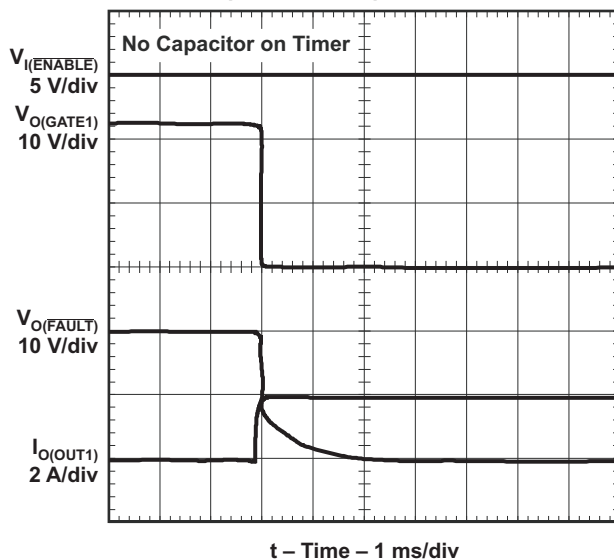

Figure 6. Channel 1 Overcurrent Response: an Overcurrent Load Plugged Into the Enabled Board

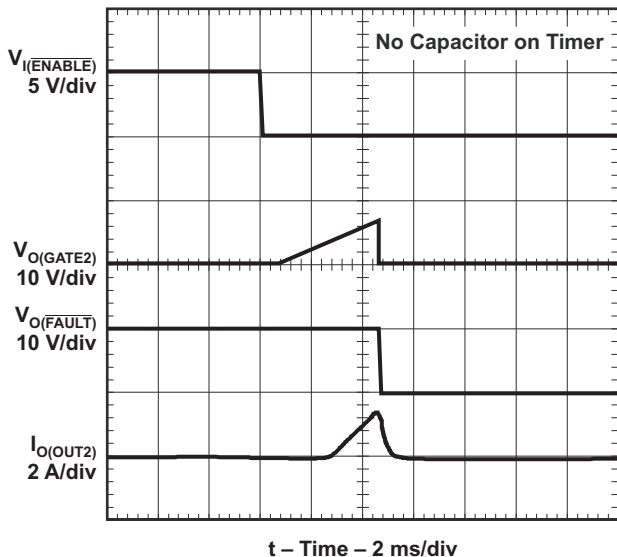

Figure 7. Channel 2 Overcurrent Response: Enabled Into Overcurrent Load

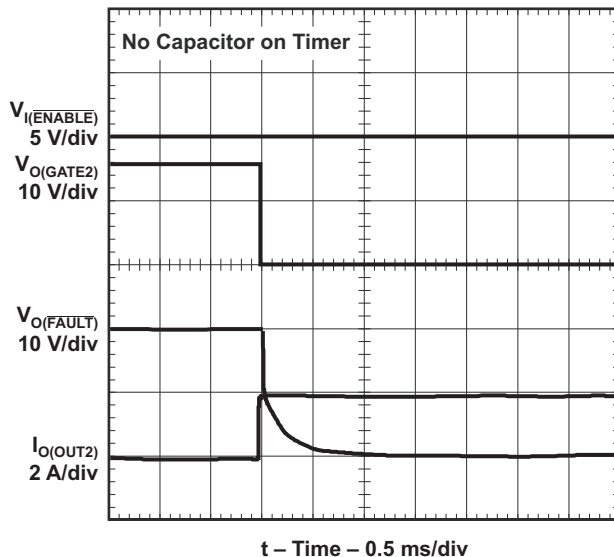

Figure 8. Channel 2 Overcurrent Response: an Overcurrent Load Plugged Into the Enabled Board

PARAMETER MEASUREMENT INFORMATION (continued)

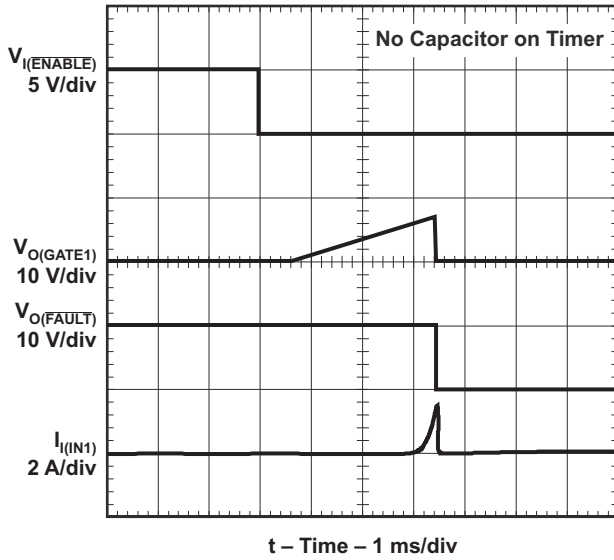

Figure 9. Channel 1 – Enabled Into Short Circuit

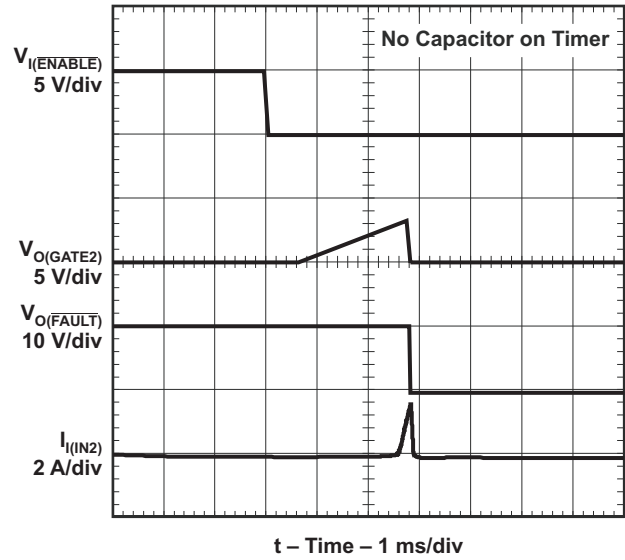

Figure 10. Channel 2 – Enabled Into Short Circuit

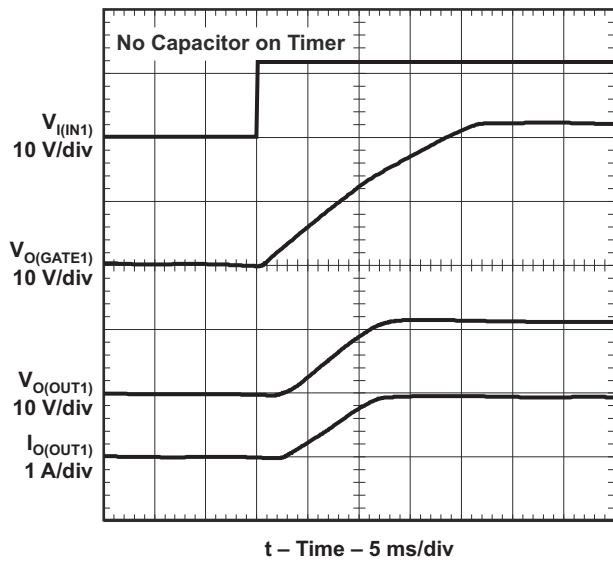

Figure 11. Channel 1 – Hot Plug

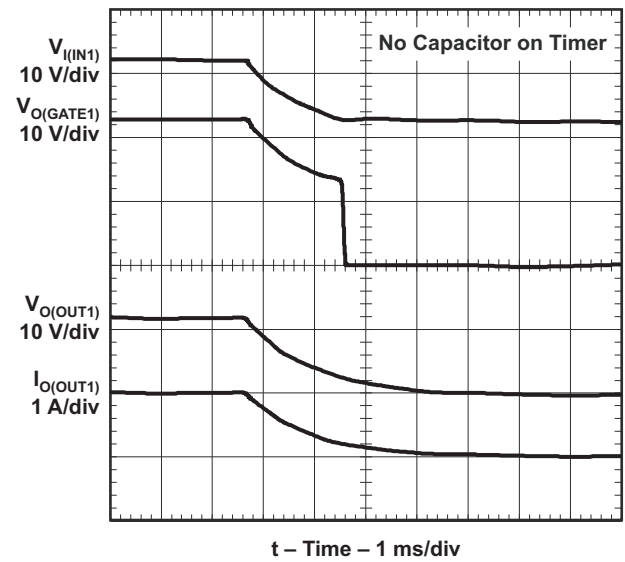

Figure 12. Channel 1 – Hot Removal

PARAMETER MEASUREMENT INFORMATION (continued)

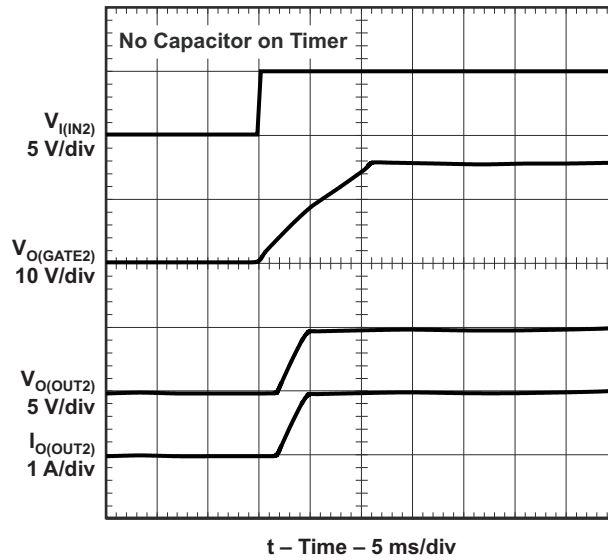

Figure 13. Channel 2 - Hot Plug

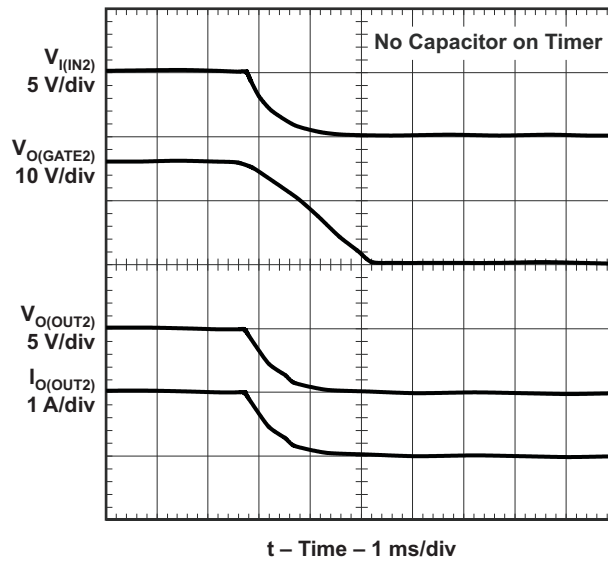
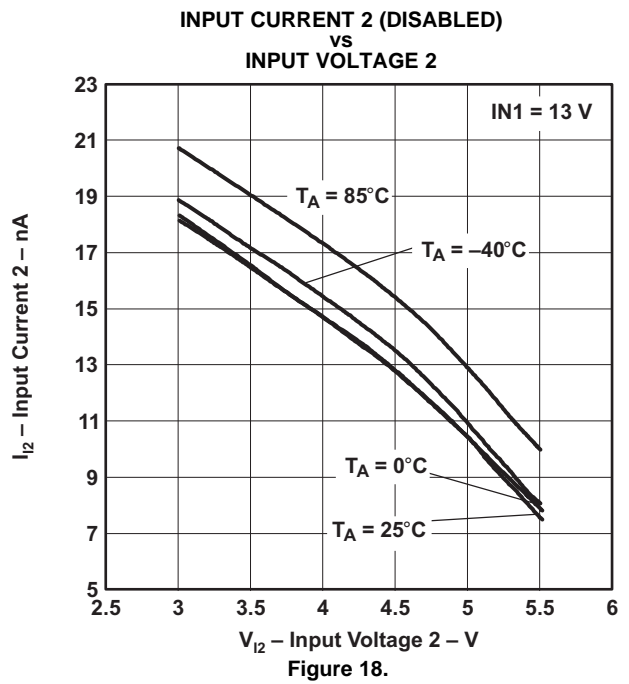
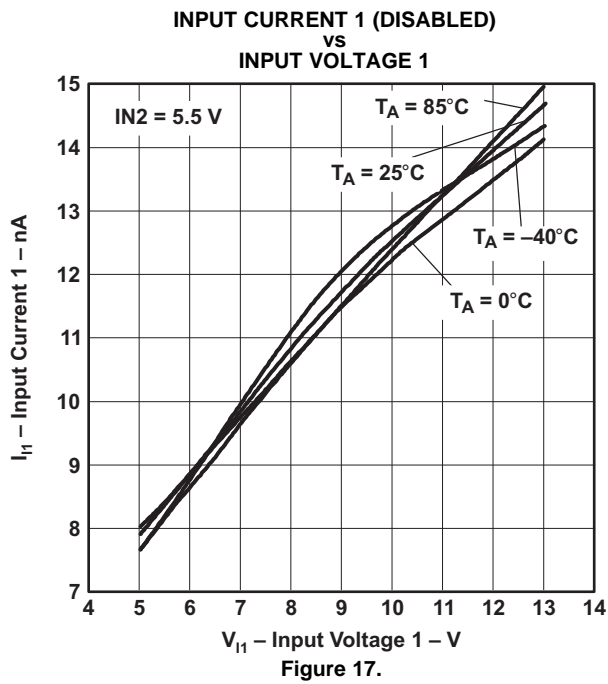
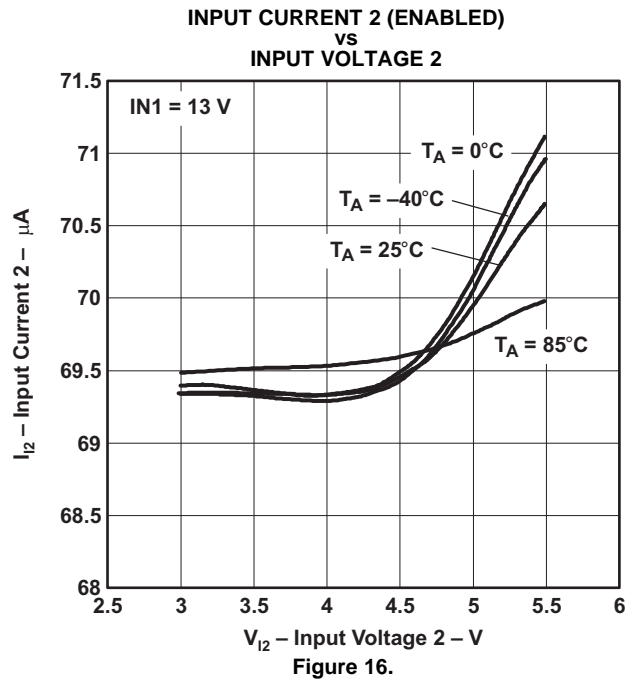
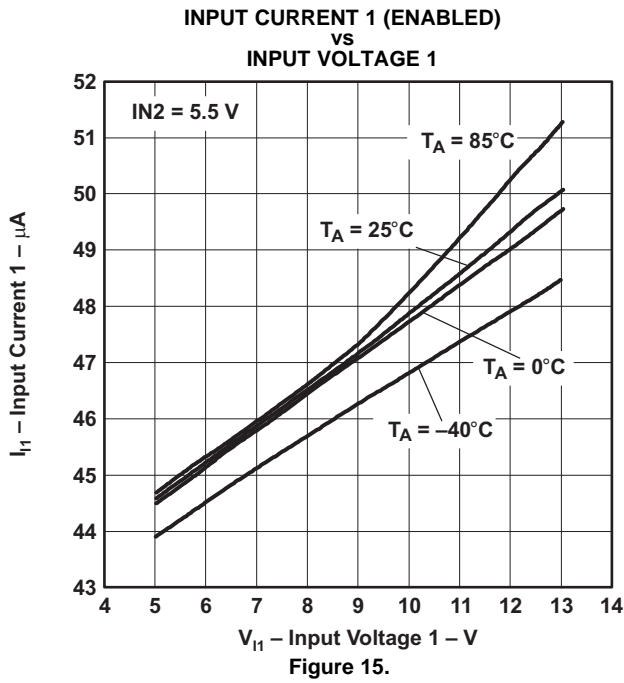

Figure 14. Channel 2 - Hot Removal

TYPICAL CHARACTERISTICS



TYPICAL CHARACTERISTICS (continued)

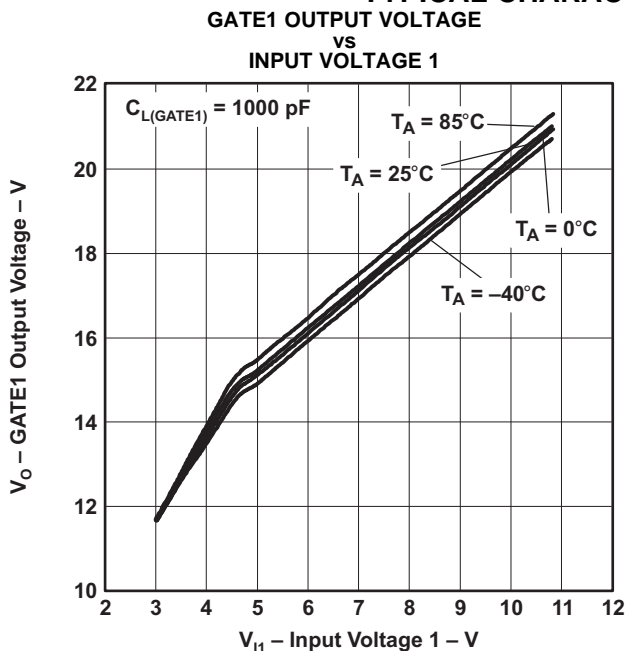

Figure 19.

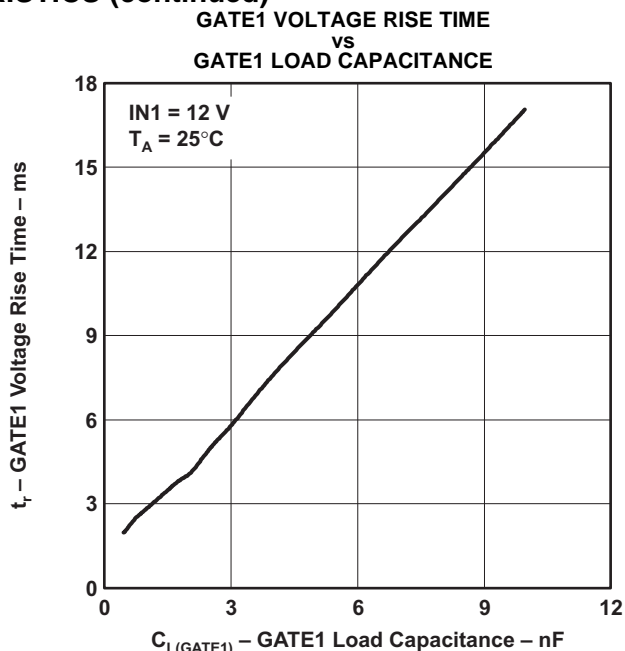

Figure 20.

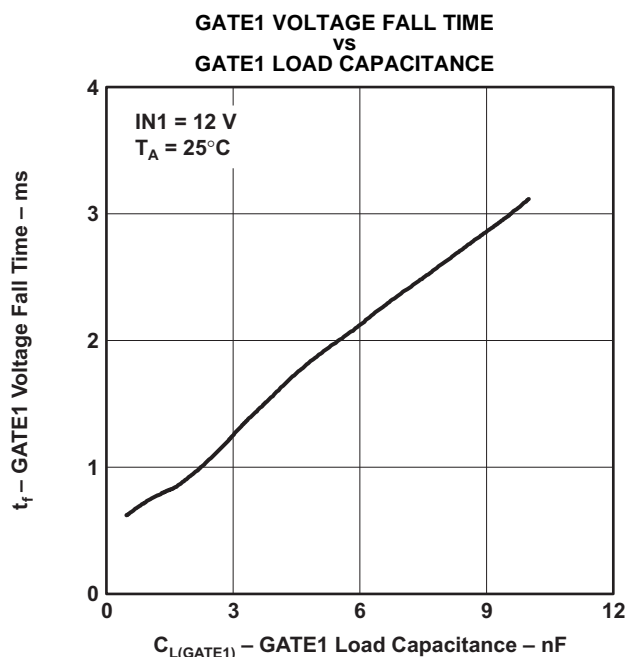

Figure 21.

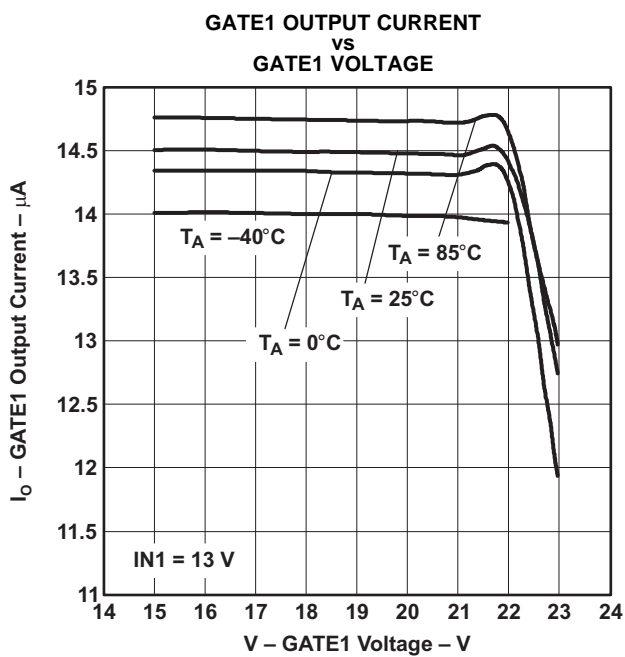

Figure 22.

TYPICAL CHARACTERISTICS (continued)

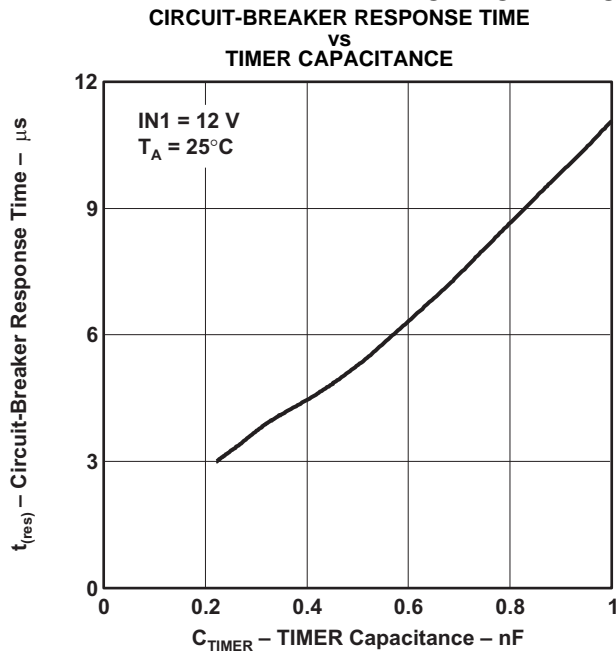

Figure 23.

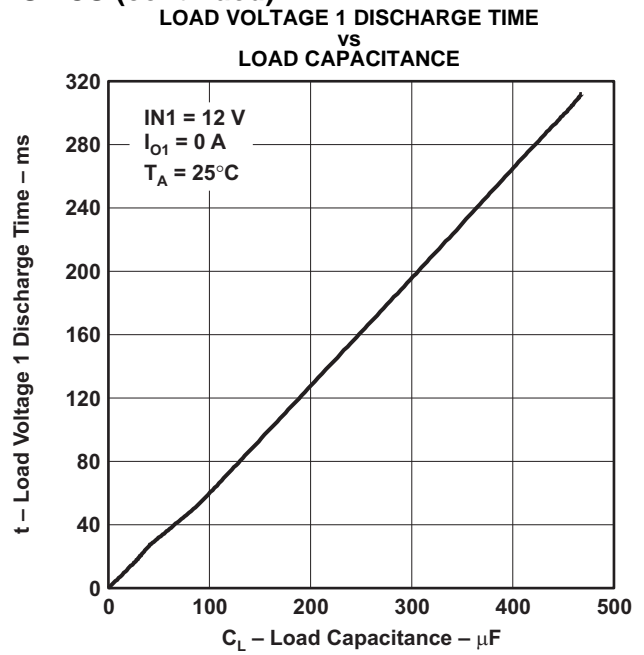

Figure 24.

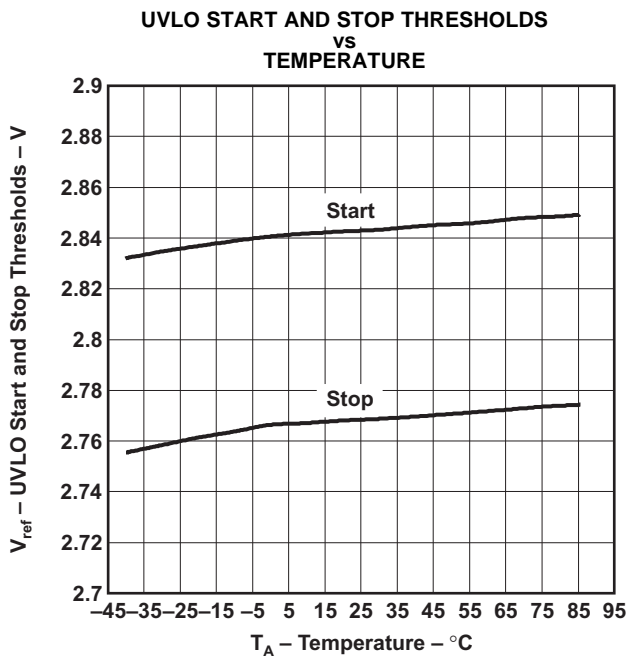

Figure 25.

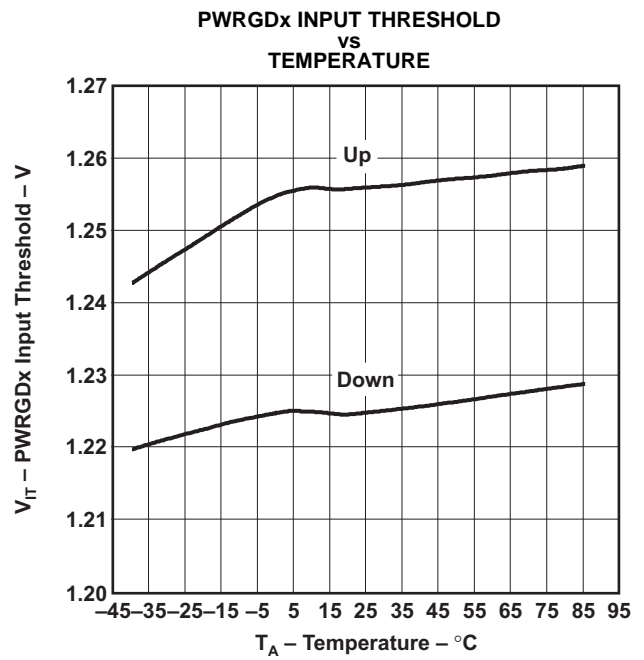

Figure 26.

APPLICATION INFORMATION

TYPICAL APPLICATION DIAGRAM

This diagram shows a typical dual hot-swap application. The pullup resistors at PG1, PG2 and $\overline{\text{FAULT}}$ should be relatively large (e.g. 100 k Ω) to reduce power loss unless they are required to drive a large load.

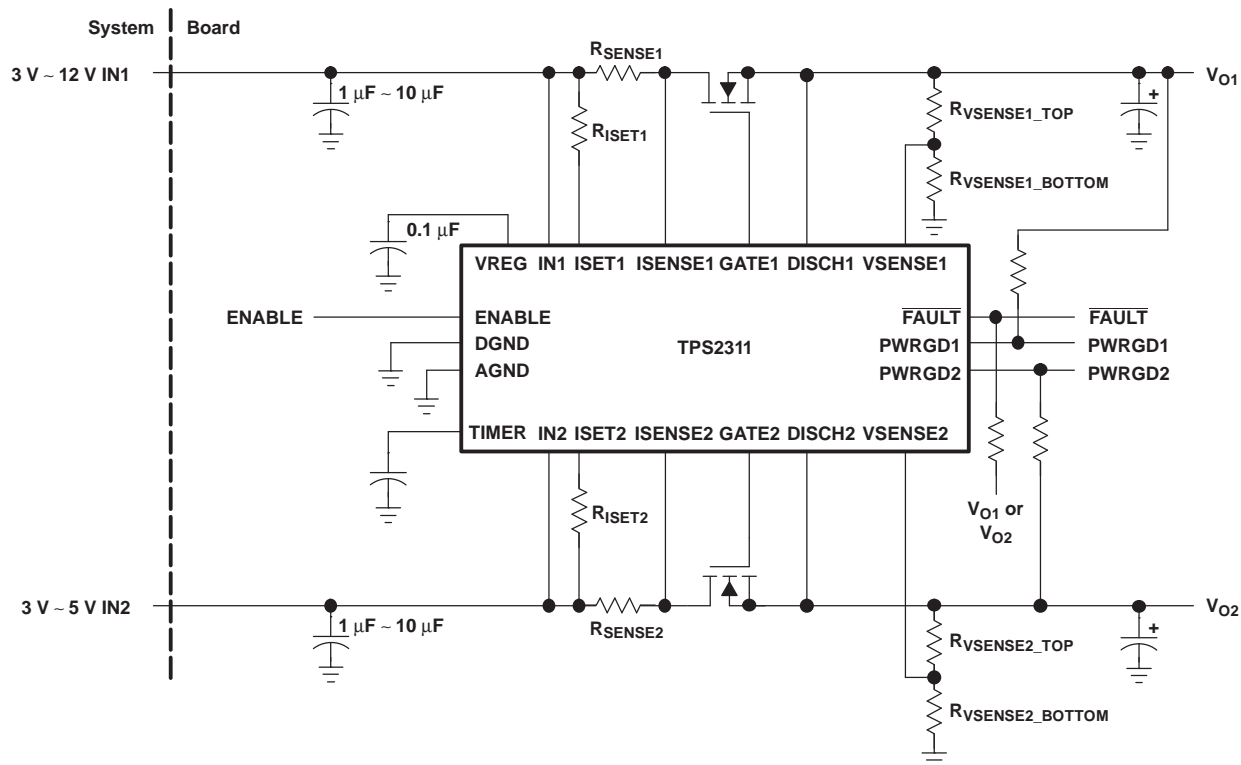

Figure 27. Typical Dual Hot-Swap Application

INPUT CAPACITOR

A 0.1- μF ceramic capacitor in parallel with a 1- μF ceramic capacitor should be placed on the input power terminals near the connector on the hot-plug board to help stabilize the voltage rails on the cards. The TPS2310/11 does not need to be mounted near the connector or these input capacitors. For applications with more severe power environments, a 2.2- μF or higher ceramic capacitor is recommended near the input terminals of the hot-plug board. A bypass capacitor for IN1 and for IN2 should be placed close to the device.

OUTPUT CAPACITOR

A 0.1- μF ceramic capacitor is recommended per load on the TPS2311; these capacitors should be placed close to the external FETs and to TPS2310/11. A larger bulk capacitor is also recommended on the load. The value of the bulk capacitor should be selected based on the power requirements and the transients generated by the application.

EXTERNAL FET

To deliver power from the input sources to the loads, each channel needs an external N-channel MOSFET. A few widely used MOSFETs are shown in Table 3. But many other MOSFETs in the market can also be used with TPS23xx in hot-swap systems.

Table 3. Some Available N-Channel MOSFETs

CURRENT RANGE (A)	PART NUMBER	DESCRIPTION	MANUFACTURER
0 to 2	IRF7601	N-channel, $r_{DS(on)} = 0.035 \Omega$, 4.6 A, Micro-8	International Rectifier
	MTSF3N03HDR2	N-channel, $r_{DS(on)} = 0.040 \Omega$, 4.6 A, Micro-8	ON Semiconductor
	IRF7101	Dual N-channel, $r_{DS(on)} = 0.1 \Omega$, 2.3 A, SO-8	International Rectifier
	MMSF5N02HDR2	Dual N-channel, $r_{DS(on)} = 0.04 \Omega$, 5 A, SO-8	ON Semiconductor
2 to 5	IRF7401	N-channel, $r_{DS(on)} = 0.022 \Omega$, 7 A, SO-8	International Rectifier
	MMSF5N02HDR2	N-channel, $r_{DS(on)} = 0.025 \Omega$, 5 A, SO-8	ON Semiconductor
	IRF7313	Dual N-channel, $r_{DS(on)} = 0.029 \Omega$, 5.2 A, SO-8	International Rectifier
	SI4410	N-channel, $r_{DS(on)} = 0.020 \Omega$, 8 A, SO-8	Vishay Dale
5 to 10	IRLR3103	N-channel, $r_{DS(on)} = 0.019 \Omega$, 29 A, d-Pak	International Rectifier
	IRLR2703	N-channel, $r_{DS(on)} = 0.045 \Omega$, 14 A, d-Pak	International Rectifier

TIMER

For most applications, a minimum capacitance of 50 pF is recommended to prevent false triggering. This capacitor should be connected between TIMER and ground. The presence of an overcurrent condition on either channel of the TPS2310/11 causes a 50- μ A current source to begin charging this capacitor. If the over-current condition persists until the capacitor has been charged to approximately 0.5 V, the TPS2310/11 latches off all channels and pulls the FAULT pin low. The timer capacitor can be made as large as desired to provide additional time delay before registering a fault condition. The time delay is approximately:

$$dt(\text{sec}) = C_{\text{TIMER}}(\text{F}) \times 10,000(\Omega).$$

OUTPUT-VOLTAGE SLEW-RATE CONTROL

When enabled, the TPS2310/11 controllers supply the gates of each external MOSFET transistor with a current of approximately 15 μ A. The slew rate of the MOSFET source voltage is thus limited by the gate-to-drain capacitance C_{gd} of the external MOSFET capacitor to a value approximating:

$$\frac{dV_s}{dt} = \frac{15 \mu\text{A}}{C_{gd}} \quad (1)$$

If a slower slew rate is desired, an additional capacitance can be connected between the gate of the external MOSFET and ground.

VREG CAPACITOR

The internal voltage regulator connected to VREG requires an external capacitor to ensure stability. A 0.1- μ F or 0.22- μ F ceramic capacitor is recommended.

GATE DRIVE CIRCUITRY

The TPS2310/11 includes four separate features associated with each gate-drive terminal:

- A charging current of approximately 15 μ A is applied to enable the external MOSFET transistor. This current is generated by an internal charge pump that can develop a gate-to-source potential (referenced to DISCH1 or DISCH2) of 9 V–12 V. DISCH1 and DISCH2 must be connected to the respective external MOSFET source terminals to ensure proper operation of this circuitry.
- A discharge current of approximately 75 μ A is applied to disable the external MOSFET transistor. Once the transistor gate voltage has dropped below approximately 1.5 V, this current is disabled and the UVLO discharge driver is enabled instead. This feature allows the part to enter a low-current shutdown mode while ensuring that the gates of the external MOSFET transistors remain at a low voltage.
- During a UVLO condition, the gates of both MOSFET transistors are pulled down by internal PMOS transistors. These transistors continue to operate even if IN1 and IN2 are both at 0 V. This circuitry also helps hold the external MOSFET transistors off when power is suddenly applied to the system.
- During an overcurrent fault condition, the external MOSFET transistor that exhibited an over-current condition is rapidly turned off by an internal pulldown circuit capable of pulling in excess of 400 mA (at 4 V) from the

pin. Once the gate has been pulled below approximately 1.5 V, this driver is disengaged and the UVLO driver is enabled instead. If any channel experiences an overcurrent condition, then both channels are turned off rapidly.

SETTING THE CURRENT-LIMIT CIRCUIT-BREAKER THRESHOLD

Using channel 1 as an example, the current sensing resistor $R_{ISENSE1}$ and the current limit setting resistor R_{ISET1} determine the current limit of the channel, and can be calculated by the following equation:

$$I_{LMT1} = \frac{R_{ISET1} \times 50 \times 10^{-6}}{R_{ISENSE1}} \quad (2)$$

Typically $R_{ISENSE1}$ is usually very small (0.001 Ω to 0.1 Ω). If the trace and solder-junction resistances between the junction of $R_{ISENSE1}$ and ISENSE1 and the junction of $R_{ISENSE1}$ and R_{ISET1} are greater than 10% of the $R_{ISENSE1}$ value, then these resistance values should be added to the $R_{ISENSE1}$ value used in the calculation above.

The above information and calculation also apply to channel 2. [Table 4](#) shows some of the current sense resistors available in the market.

Table 4. Some Current Sense Resistors

CURRENT RANGE (A)	PART NUMBER	DESCRIPTION	MANUFACTURER
0 to 1	WSL-1206, 0.05 1%	0.05 Ω , 0.25 W, 1% resistor	Vishay Dale
1 to 2	WSL-1206, 0.025 1%	0.025 Ω , 0.25 W, 1% resistor	
2 to 4	WSL-1206, 0.015 1%	0.015 Ω , 0.25 W, 1% resistor	
4 to 6	WSL-2010, 0.010 1%	0.010 Ω , 0.5 W, 1% resistor	
6 to 8	WSL-2010, 0.007 1%	0.007 Ω , 0.5 W, 1% resistor	
8 to 10	WSR-2, 0.005 1%	0.005 Ω , 0.5 W, 1% resistor	

SETTING THE POWER-GOOD THRESHOLD VOLTAGE

The two feedback resistors $R_{VSENSEX_TOP}$ and $R_{VSENSEX_BOT}$ connected between V_{OX} and ground form a resistor divider setting the voltage at the $VSENSEx$ pins. $VSENSE1$ voltage equals:

$$V_{I(SENSE1)} = V_{O1} \times R_{VSENSE1_BOT} / (R_{VSENSE1_TOP} + R_{VSENSE1_BOT})$$

This voltage is compared to an internal voltage reference (1.225 V \pm 2%) to determine whether the output voltage level is within a specified tolerance. For example, given a nominal output voltage at V_{O1} , and defining V_{O1_min} as the minimum required output voltage, then the feedback resistors are defined by:

$$R_{VSENSE1_TOP} = \frac{V_{O1_min} - 1.225}{1.225} \times R_{VSENSE1_BOT} \quad (3)$$

Start the process by selecting a large standard resistor value for $R_{VSENSE1_BOT}$ to reduce power loss. Then $R_{VSENSE1_TOP}$ can be calculated by inserting all of the known values into the equation above. When V_{O1} is lower than V_{O1_min} , PWRGD1 is low as long as the controller is enabled.

UNDERVOLTAGE LOCKOUT (UVLO)

The TPS2310/11 includes an undervoltage lockout (UVLO) feature that monitors the voltage present on the VREG pin. This feature disables both external MOSFETs if the voltage on VREG drops below 2.78 V (nominal) and re-enables normal operation when it rises above 2.85 V (nominal). Since VREG is fed from IN1 through a low-dropout voltage regulator, the voltage on VREG tracks the voltage on IN1 within 50 mV. While the undervoltage lockout is engaged, both GATE1 and GATE2 are held low by internal PMOS pulldown transistors, ensuring that the external MOSFET transistors remain off at all times, even if all power supplies have fallen to 0 V.

SINGLE-CHANNEL OPERATION

Some applications may require only a single external MOS transistor. Such applications should use GATE1 and the associated circuitry (IN1, ISENSE1, ISET1, DISCH1). The IN2 pin should be grounded to disable the circuitry associated with the GATE2 pin. The VSENSE2 and PWRGD2 circuitry is unaffected by disabling GATE2, and may still be used if so desired.

POWER-UP CONTROL

The TPS2310/11 includes a 500 μ s (nominal) start-up delay that ensures that internal circuitry has sufficient time to start before the device begins turning on the external MOSFETs. This delay is triggered only upon the rapid application of power to the circuit. If the power supply ramps up slowly, the undervoltage lockout circuitry provides adequate protection against undervoltage operation.

3-CHANNEL HOT-SWAP APPLICATION

Some applications require hot-swap control of up to three voltage rails, but may not explicitly require the sensing of the status of the output power on all three of the voltage rails. One such application is device bay, where dv/dt control of 3.3 V, 5 V, and 12 V is required. By using channel 2 to drive both the 3.3-V and 5-V power rails and channel 1 to drive the 12-V power rail, as is shown below, TPS2310/11 can deliver three different voltages to three loads while monitoring the status of two of the loads.

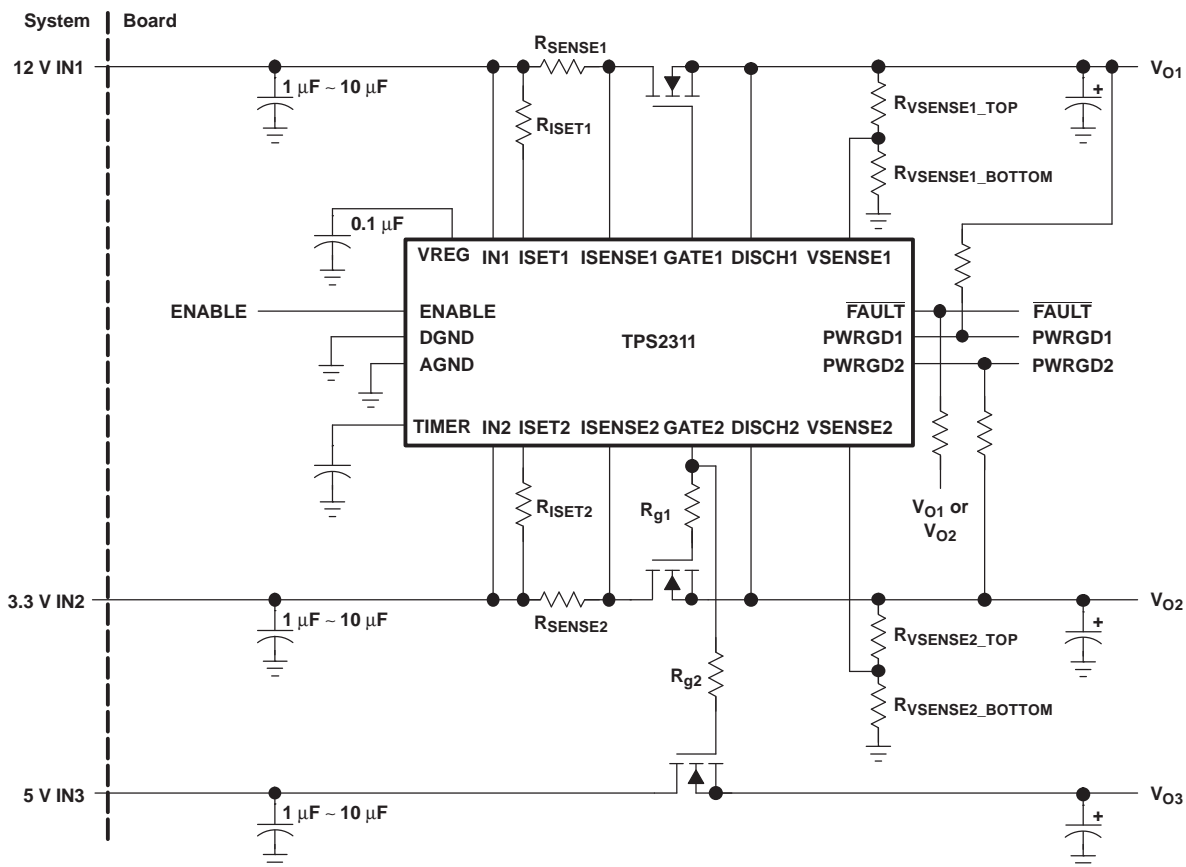

Figure 28. Three-Channel Application

Figure 29 shows ramp-up waveforms of the three output voltages.

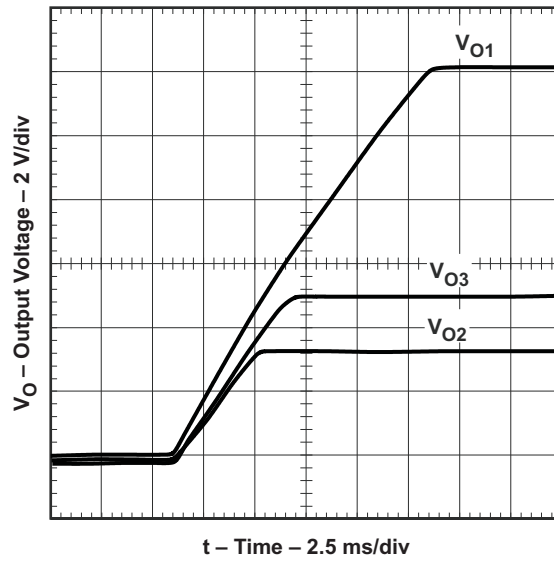

Figure 29.

REVISION HISTORY

Note: Revision history for previous versions is not available. Page numbers of previous versions may differ.

Changes from Revision G (November 2006) to Revision H	Page
• Added text to ISENSE1, ISENSE2, ISET1, ISET2 pin description paragraph for clarification.	3
• Added additional V_I specs to ROC table for clarification	5
• Added minus sign to 40°C MIN T_J temperature	5

PACKAGING INFORMATION

Orderable Device	Status (1)	Package Type	Package Drawing	Pins	Package Qty	Eco Plan (2)	Lead finish/ Ball material (6)	MSL Peak Temp (3)	Op Temp (°C)	Device Marking (4/5)	Samples
TPS2310IPW	ACTIVE	TSSOP	PW	20	70	RoHS & Green	NIPDAU	Level-1-260C-UNLIM	-40 to 85	TPS2310I	Samples
TPS2310IPWG4	ACTIVE	TSSOP	PW	20	70	TBD	Call TI	Call TI	-40 to 85		Samples
TPS2311IPW	ACTIVE	TSSOP	PW	20	70	RoHS & Green	NIPDAU	Level-1-260C-UNLIM	-40 to 85	TPS2311I	Samples
TPS2311IPWR	ACTIVE	TSSOP	PW	20	2000	RoHS & Green	NIPDAU	Level-1-260C-UNLIM	-40 to 85	TPS2311I	Samples

(1) The marketing status values are defined as follows:

ACTIVE: Product device recommended for new designs.

LIFEBUY: TI has announced that the device will be discontinued, and a lifetime-buy period is in effect.

NRND: Not recommended for new designs. Device is in production to support existing customers, but TI does not recommend using this part in a new design.

PREVIEW: Device has been announced but is not in production. Samples may or may not be available.

OBSELETE: TI has discontinued the production of the device.

(2) **RoHS:** TI defines "RoHS" to mean semiconductor products that are compliant with the current EU RoHS requirements for all 10 RoHS substances, including the requirement that RoHS substance do not exceed 0.1% by weight in homogeneous materials. Where designed to be soldered at high temperatures, "RoHS" products are suitable for use in specified lead-free processes. TI may reference these types of products as "Pb-Free".

RoHS Exempt: TI defines "RoHS Exempt" to mean products that contain lead but are compliant with EU RoHS pursuant to a specific EU RoHS exemption.

Green: TI defines "Green" to mean the content of Chlorine (Cl) and Bromine (Br) based flame retardants meet JS709B low halogen requirements of <=1000ppm threshold. Antimony trioxide based flame retardants must also meet the <=1000ppm threshold requirement.

(3) MSL, Peak Temp. - The Moisture Sensitivity Level rating according to the JEDEC industry standard classifications, and peak solder temperature.

(4) There may be additional marking, which relates to the logo, the lot trace code information, or the environmental category on the device.

(5) Multiple Device Markings will be inside parentheses. Only one Device Marking contained in parentheses and separated by a "-" will appear on a device. If a line is indented then it is a continuation of the previous line and the two combined represent the entire Device Marking for that device.

(6) Lead finish/Ball material - Orderable Devices may have multiple material finish options. Finish options are separated by a vertical ruled line. Lead finish/Ball material values may wrap to two lines if the finish value exceeds the maximum column width.

Important Information and Disclaimer:The information provided on this page represents TI's knowledge and belief as of the date that it is provided. TI bases its knowledge and belief on information provided by third parties, and makes no representation or warranty as to the accuracy of such information. Efforts are underway to better integrate information from third parties. TI has taken and

continues to take reasonable steps to provide representative and accurate information but may not have conducted destructive testing or chemical analysis on incoming materials and chemicals. TI and TI suppliers consider certain information to be proprietary, and thus CAS numbers and other limited information may not be available for release.

In no event shall TI's liability arising out of such information exceed the total purchase price of the TI part(s) at issue in this document sold by TI to Customer on an annual basis.

TAPE AND REEL INFORMATION

QUADRANT ASSIGNMENTS FOR PIN 1 ORIENTATION IN TAPE

*All dimensions are nominal

Device	Package Type	Package Drawing	Pins	SPQ	Reel Diameter (mm)	Reel Width W1 (mm)	A0 (mm)	B0 (mm)	K0 (mm)	P1 (mm)	W (mm)	Pin1 Quadrant
TPS2311PWR	TSSOP	PW	20	2000	330.0	16.4	6.95	7.1	1.6	8.0	16.0	Q1

TAPE AND REEL BOX DIMENSIONS

*All dimensions are nominal

Device	Package Type	Package Drawing	Pins	SPQ	Length (mm)	Width (mm)	Height (mm)
TPS2311IPWR	TSSOP	PW	20	2000	356.0	356.0	35.0

TUBE

*All dimensions are nominal

Device	Package Name	Package Type	Pins	SPQ	L (mm)	W (mm)	T (μm)	B (mm)
TPS2310IPW	PW	TSSOP	20	70	530	10.2	3600	3.5
TPS2311IPW	PW	TSSOP	20	70	530	10.2	3600	3.5

PW0020A



PACKAGE OUTLINE

TSSOP - 1.2 mm max height

SMALL OUTLINE PACKAGE



4220206/A 02/2017

NOTES:

- All linear dimensions are in millimeters. Any dimensions in parenthesis are for reference only. Dimensioning and tolerancing per ASME Y14.5M.
- This drawing is subject to change without notice.
- This dimension does not include mold flash, protrusions, or gate burrs. Mold flash, protrusions, or gate burrs shall not exceed 0.15 mm per side.
- This dimension does not include interlead flash. Interlead flash shall not exceed 0.25 mm per side.
- Reference JEDEC registration MO-153.

EXAMPLE BOARD LAYOUT

PW0020A

TSSOP - 1.2 mm max height

SMALL OUTLINE PACKAGE



LAND PATTERN EXAMPLE
EXPOSED METAL SHOWN
SCALE: 10X



SOLDER MASK DETAILS

4220206/A 02/2017

NOTES: (continued)

- 6. Publication IPC-7351 may have alternate designs.
- 7. Solder mask tolerances between and around signal pads can vary based on board fabrication site.

EXAMPLE STENCIL DESIGN

PW0020A

TSSOP - 1.2 mm max height

SMALL OUTLINE PACKAGE



SOLDER PASTE EXAMPLE
BASED ON 0.125 mm THICK STENCIL
SCALE: 10X

4220206/A 02/2017

NOTES: (continued)

8. Laser cutting apertures with trapezoidal walls and rounded corners may offer better paste release. IPC-7525 may have alternate design recommendations.
9. Board assembly site may have different recommendations for stencil design.

PW (R-PDSO-G20)

PLASTIC SMALL OUTLINE

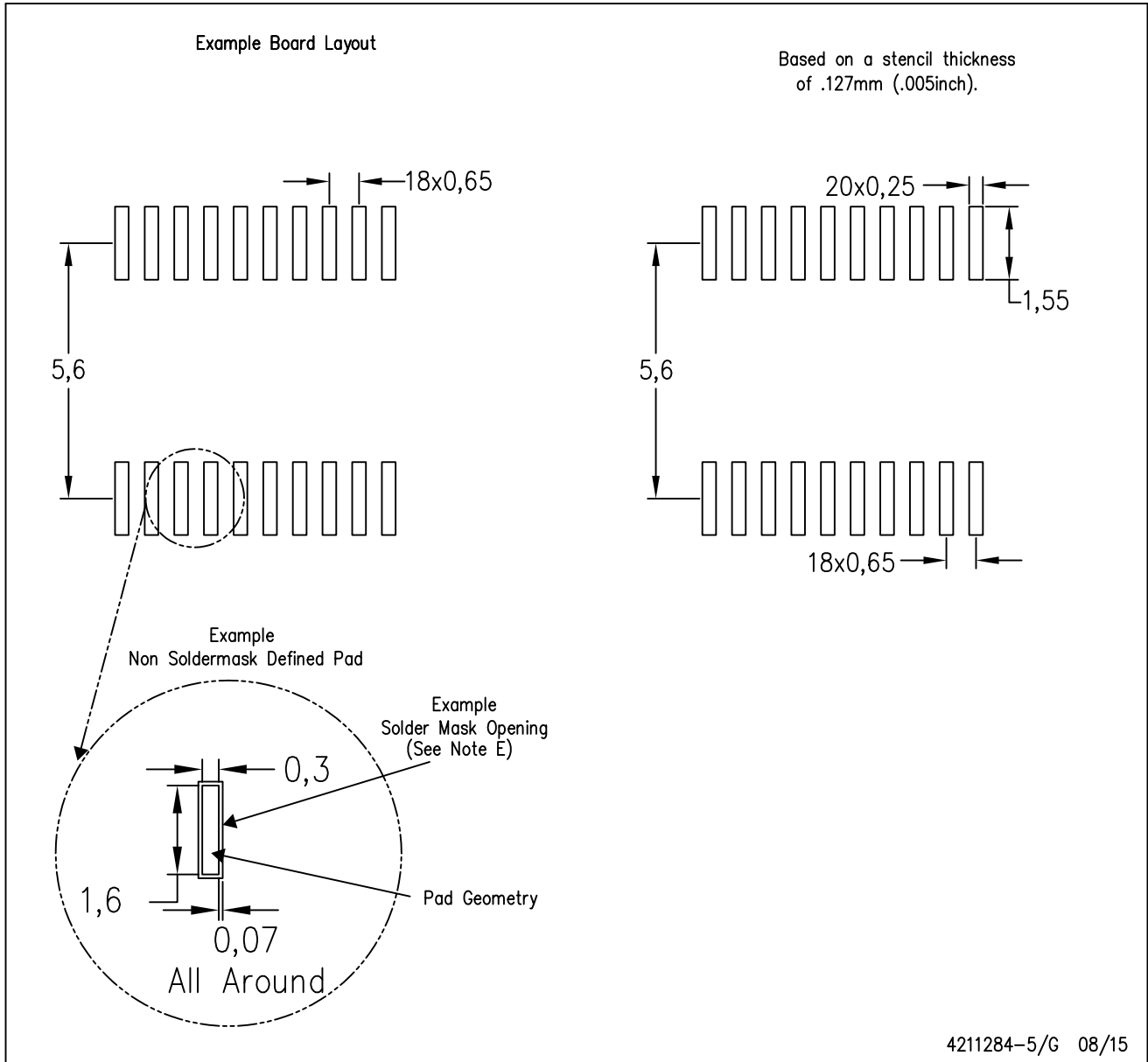

- NOTES:
- A. All linear dimensions are in millimeters.
 - B. This drawing is subject to change without notice.
 - C. Publication IPC-7351 is recommended for alternate design.
 - D. Laser cutting apertures with trapezoidal walls and also rounding corners will offer better paste release. Customers should contact their board assembly site for stencil design recommendations. Refer to IPC-7525 for other stencil recommendations.
 - E. Customers should contact their board fabrication site for solder mask tolerances between and around signal pads.

IMPORTANT NOTICE AND DISCLAIMER

TI PROVIDES TECHNICAL AND RELIABILITY DATA (INCLUDING DATA SHEETS), DESIGN RESOURCES (INCLUDING REFERENCE DESIGNS), APPLICATION OR OTHER DESIGN ADVICE, WEB TOOLS, SAFETY INFORMATION, AND OTHER RESOURCES "AS IS" AND WITH ALL FAULTS, AND DISCLAIMS ALL WARRANTIES, EXPRESS AND IMPLIED, INCLUDING WITHOUT LIMITATION ANY IMPLIED WARRANTIES OF MERCHANTABILITY, FITNESS FOR A PARTICULAR PURPOSE OR NON-INFRINGEMENT OF THIRD PARTY INTELLECTUAL PROPERTY RIGHTS.

These resources are intended for skilled developers designing with TI products. You are solely responsible for (1) selecting the appropriate TI products for your application, (2) designing, validating and testing your application, and (3) ensuring your application meets applicable standards, and any other safety, security, regulatory or other requirements.

These resources are subject to change without notice. TI grants you permission to use these resources only for development of an application that uses the TI products described in the resource. Other reproduction and display of these resources is prohibited. No license is granted to any other TI intellectual property right or to any third party intellectual property right. TI disclaims responsibility for, and you will fully indemnify TI and its representatives against, any claims, damages, costs, losses, and liabilities arising out of your use of these resources.

TI's products are provided subject to [TI's Terms of Sale](#) or other applicable terms available either on ti.com or provided in conjunction with such TI products. TI's provision of these resources does not expand or otherwise alter TI's applicable warranties or warranty disclaimers for TI products.

TI objects to and rejects any additional or different terms you may have proposed.

Mailing Address: Texas Instruments, Post Office Box 655303, Dallas, Texas 75265
Copyright © 2022, Texas Instruments Incorporated