

Space Optimized, “Clam Shell” Layout for Step-Down DC/DC Converters

Jim Perkins, Matthias Ulmann

Monolithic Catalog Power

ABSTRACT

An optimized layout is critical to good DC/DC regulator performance, and there have been whole libraries written on DC/DC converter layout. Some really useful articles are Tim Hegarty’s three-part series on DC/DC layout published in EDN^[1], and Chris Glaser’s paper in the *TI Analog Applications Journal*^[2]. There are many factors to be considered in achieving a good layout. Some are critical to performance while others are perhaps marginal (and un-proven!).

The demand for smaller electronic products packed with more features means that the most space efficient layout is also desired. DC/DC converter ICs are available in tiny packages and it is generally the inductor which is the largest component. This paper examines the use of both sides of the PCB to achieve the most space efficient DC/DC converter layout while maintaining optimal performance.

Contents

1	Critical Steps in DC/DC Layout	2
2	Double-Sided Layout	2
3	Testing the Theory.....	2
4	Conclusions	10
5	References	11

List of Figures

1	TPS563209DDCR 12 V to 2.5 V at 2.5 A	2
2	Layout 1 - Single Sided	3
3	Layout 2 - Inductor on Other Side	3
4	Layout 3 - Inductor + Output Capacitors on Other Side	3
5	Test PCB.....	3
6	Output Ripple – 12 V to 2.5 V at 2.5 A. Layout 1	4
7	Output Ripple – 12 V to 2.5 V at 2.5 A, Layout 2	4
8	Output Ripple – 12 V to 2.5 V at 2.5 A, Layout 3	5
9	Output Ripple for Layout 1 With Inductor in Both Orientations	6
10	Input Ripple – 12 V to 2.5 V at 2.5 A, Layout 1.....	6
11	Input Ripple – 12 V to 2.5 V at 2.5 A, Layout 2.....	7
12	Input Ripple – 12 V to 2.5 V at 2.5 A, Layout 3	7
13	Switch Node Waveform – Layout 1	8
14	Switch Node Waveform – Layout 2	8
15	Switch Node Waveform – Layout 3	9
16	Layout 1 - IC and Inductor Topside	9
17	Layout 2 - IC Bottom Side (Left) Inductor Topside (Right).....	10
18	Layout 3 - IC Bottom Side (Left) Inductor Topside (Right).....	10

List of Tables

1	Summary of Results	10
---	--------------------------	----

1 Critical Steps in DC/DC Layout

A summary of the key layout steps, in order of priority is:

1. Place the input capacitor as close as possible to the IC with wide, short traces to the V_{IN} and P_{GND} pins. Every millimeter makes a difference! Minimize the area of the loop from C_{IN} to V_{IN} and P_{GND} back to C_{IN} .
2. Place the inductor, as close as possible to the SW pin of the device, keeping the switch node area as small as possible.
3. Place output capacitors from the inductor, returning to the P_{GND} close to the input capacitor. Again minimize the area of the loop from the SW pin through the inductor to C_{OUT} and back to P_{GND} .
4. As in the previous steps, C_{IN} , C_{OUT} , and P_{GND} are connected together to form a return path for the switching currents. This should be connected to the system GND at a single point.

2 Double-Sided Layout

It is generally a good practice to avoid layer changes and hence vias in the power loops described in [Section 1](#). This is because vias add parasitic inductance and can lead to ringing and add to EMI.

However, if the vias are directly in series with the inductor they should add to the inductance and not cause parasitic issues. This consideration suggests the IC and other components may be placed on the opposite side of the PCB to the inductor. With the IC and capacitors directly under the inductor footprint, the total PCB area used by the DC/DC converter circuit is minimized.

3 Testing the Theory

In order to test the double-sided layout ideas, a board with three versions of an identical electrical circuit was created, with three different layouts. The circuit uses the TPS563209DDCR 3-A buck regulator in an SOT23 package to convert from 12 V to 2.5 V at 2.5 A. [Figure 1](#) shows the schematic.

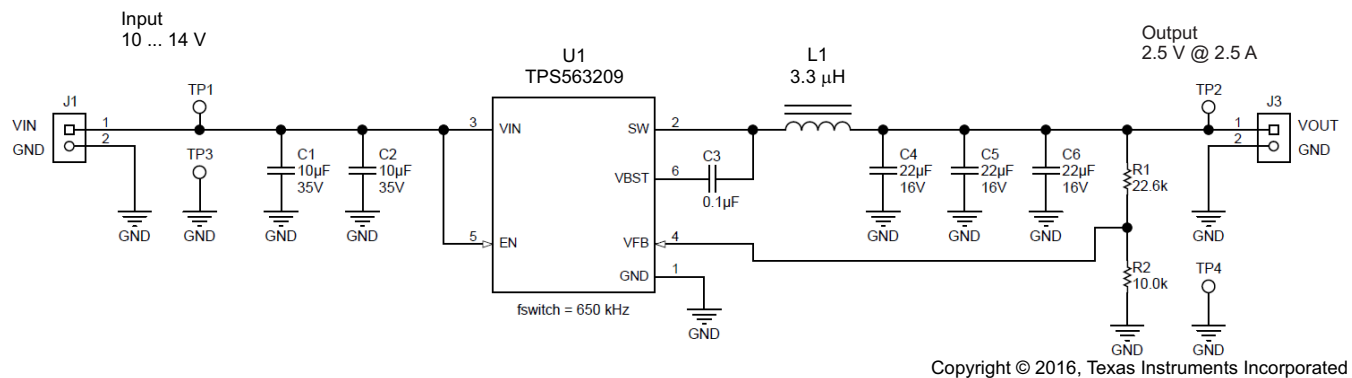

Figure 1. TPS563209DDCR 12 V to 2.5 V at 2.5 A

- Input capacitors
 - TDK C3216X5R1V106M160AB
 - 10 μ F, 35 V, 20%, X5R, 1206
 - Approx. 6 μ F at 12-V DC (-40%)
- Output capacitors
 - TDK C2012X5R1C226M125AC
 - 22 μ F, 16 V, 20%, X5R, 0805
 - Approx. 13 μ F at 2.5-V DC (-40%)
- Inductor
 - Taiyo Yuden NRS5040T3R3NMGJ
 - 3.3 μ H, 30%, 3.3 A at 40°C temperature rise, 4.0 A at 30% inductance drop

The first layout uses an entirely single-sided layout and measures 14.6 mm x 11.9 mm, with an area of 173 mm². The second layout has the inductor on the opposite side of the PCB to the IC and capacitors. The inductor on the second layout measures 13.6 mm x 10.4 mm with an area of 141 mm². The third layout has the inductor and output capacitors on the opposite side of the board to the IC and input capacitors. This final layout measures a tiny 13.5 mm x 7.8 mm, with an area of 105 mm². In both the double-sided layouts, the components on each side are directly above and below each other so the area used is the total area looking through the board.

173mm²

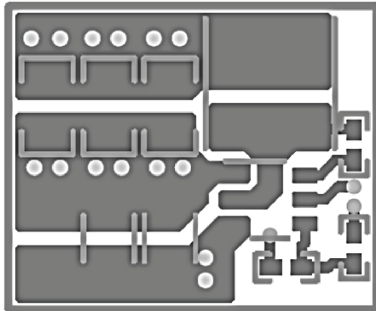

Figure 2. Layout 1 - Single Sided

141mm²

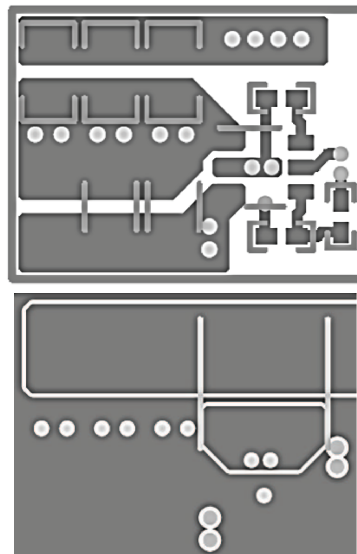

Figure 3. Layout 2 - Inductor on Other Side

105mm²

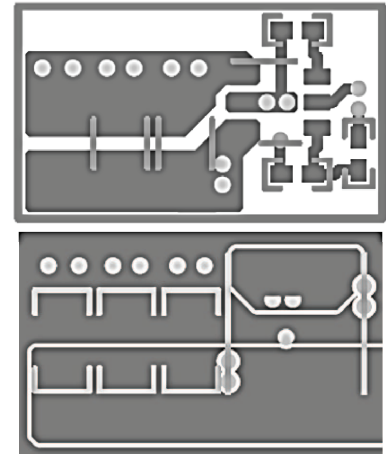

Figure 4. Layout 3 - Inductor + Output Capacitors on Other Side

Figure 5 shows the PCBs used for testing the layouts.

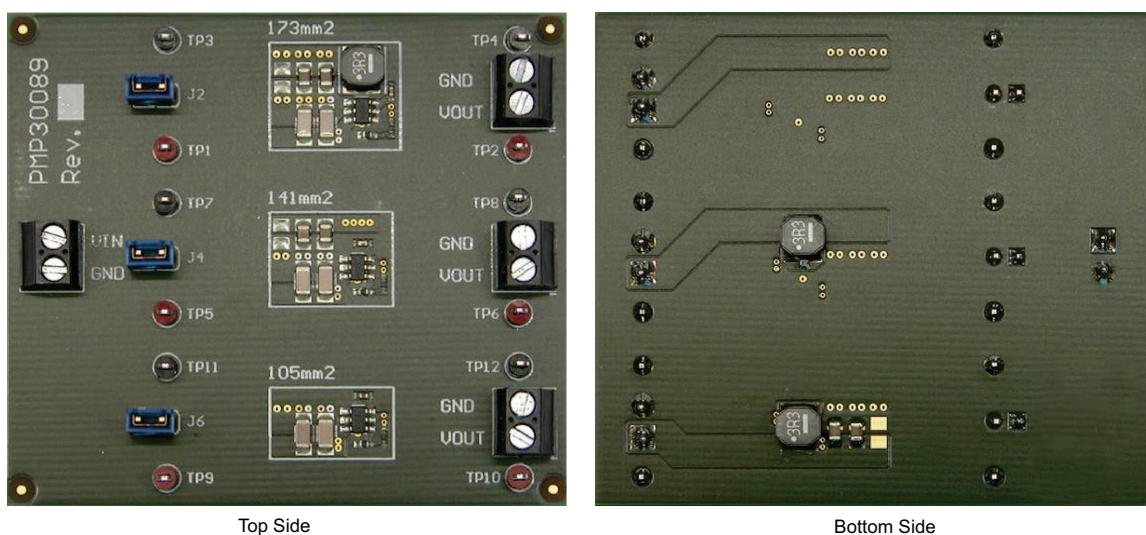

Figure 5. Test PCB

The PCBs used were 4-layer, 1-oz/35- μ m copper thickness, FR4 material. Figure 5 illustrates layers 1 and 4. Internal layers 2 and 3 were ground and 12-V, respectively.

3.1 Results – Output Ripple

Figure 6, Figure 7, and Figure 8 show the output ripple measured directly across the output capacitors using a coax lead[®].

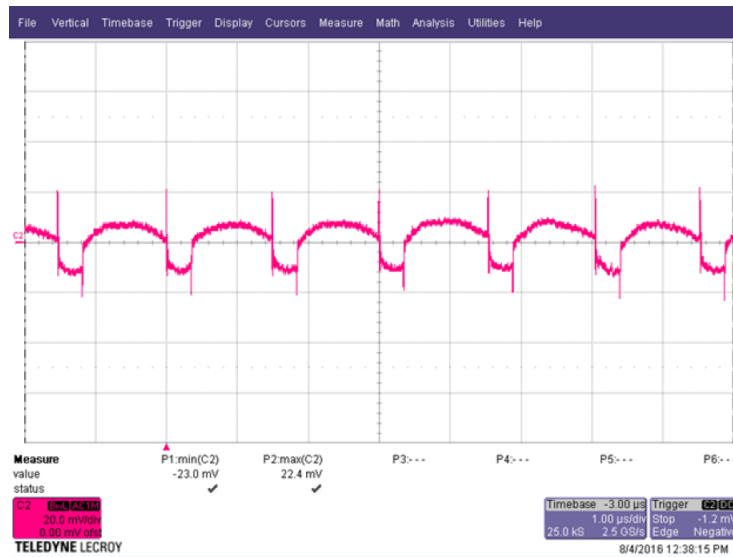

Figure 6. Output Ripple – 12 V to 2.5 V at 2.5 A. Layout 1

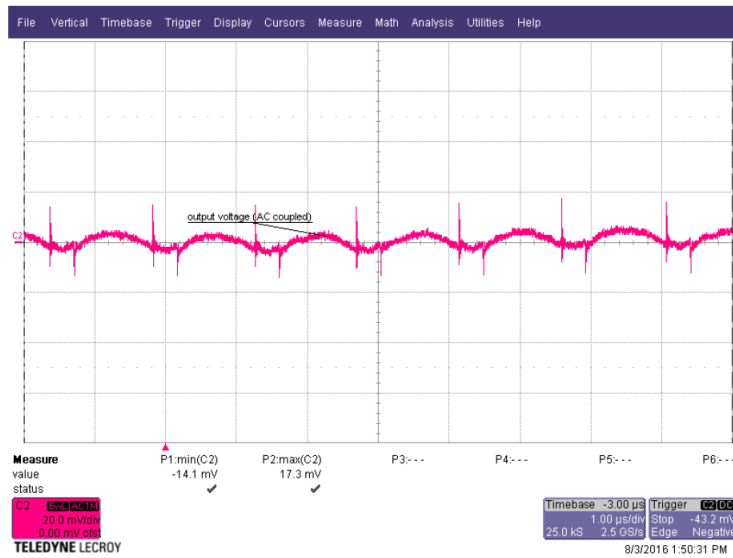

Figure 7. Output Ripple – 12 V to 2.5 V at 2.5 A, Layout 2

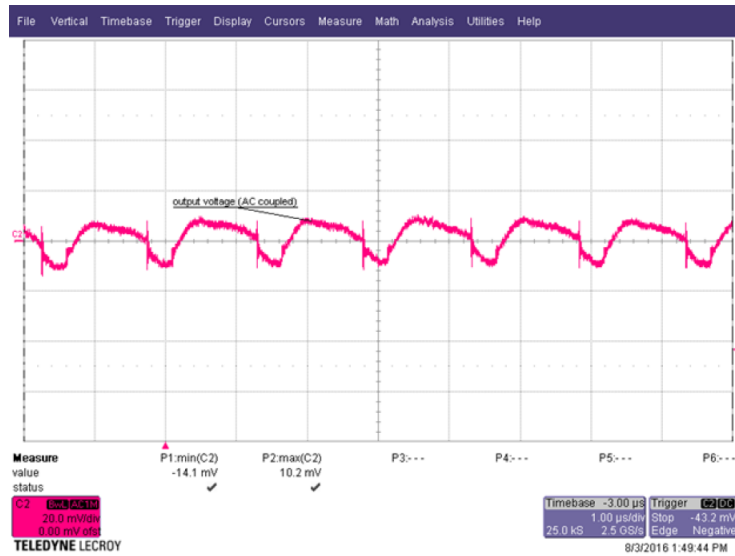

Figure 8. Output Ripple – 12 V to 2.5 V at 2.5 A, Layout 3

There is little difference between the three layouts; although the switching-edge pick up on the single-sided layout 1 is slightly higher. For layout 1, the output ripple amplitude without the ringing edges is about 24 mVpp, with the switching edge ringing taking this to 45 mV. For layout 2, the ripple is lower, approximately 14 mVpp, increasing to 32 mV with switching edge ringing. Layout 3 achieves an output ripple of 24 mVpp with the least switching edge ringing.

It is interesting to note that the orientation of the inductor can make a difference. The inductors, seen in [Figure 5](#), have a dot on one connection. This denotes the start of the winding where the conductor is closest to the central core. The other side is the end of the winding finishing on the outside of the inductor. As the SW node experiences large voltage swings with fast edges, this should be connected to the start of the coil. The quieter Vout end of the inductor windings on the outside then shield the noisier inner windings. [Figure 9](#) shows the output ripple for layout 1 with the inductor in both orientations. The brown trace is with the inner coil connected to SW and the blue is with the outer coil connected to SW. The difference is clear, although whether one is better than the other is not so obvious!

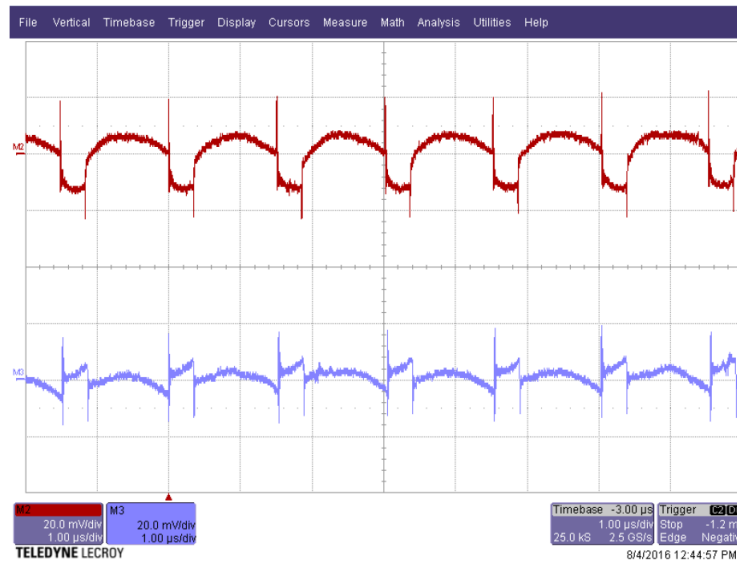

Figure 9. Output Ripple for Layout 1 With Inductor in Both Orientations

3.2 Results – Input Ripple

The input ripple was measured directly across the input capacitors of each circuit using the same coax method. There is almost no difference in input ripple between the three layouts, with 90–100 mVpp for all three layout versions.

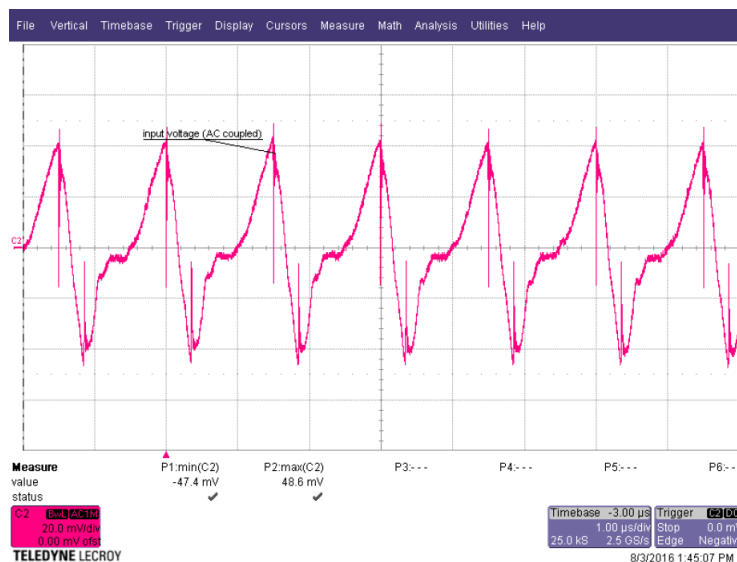

Figure 10. Input Ripple – 12 V to 2.5 V at 2.5 A, Layout 1

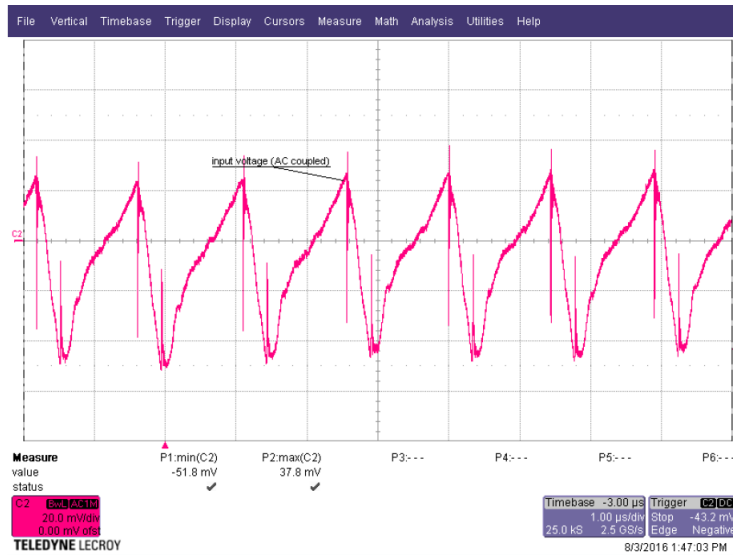

Figure 11. Input Ripple – 12 V to 2.5 V at 2.5 A, Layout 2

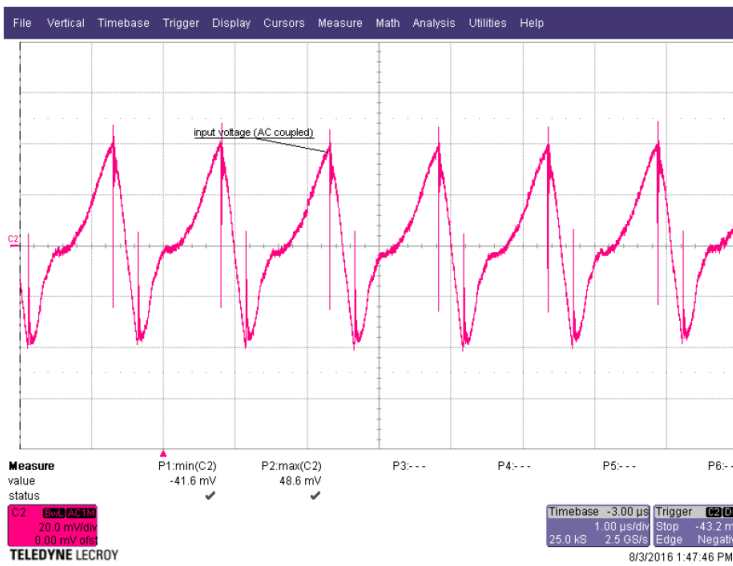

Figure 12. Input Ripple – 12 V to 2.5 V at 2.5 A, Layout 3

3.3 Results – Switch Node

The switch node ringing shows little change between layouts.

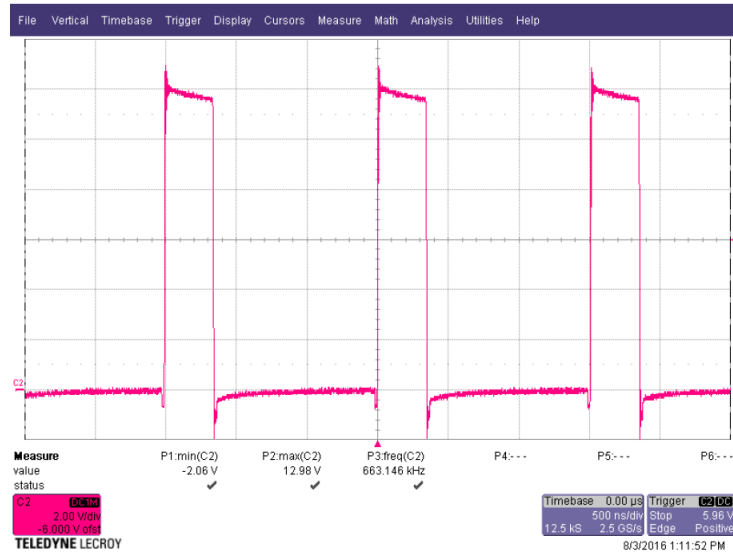

Figure 13. Switch Node Waveform – Layout 1

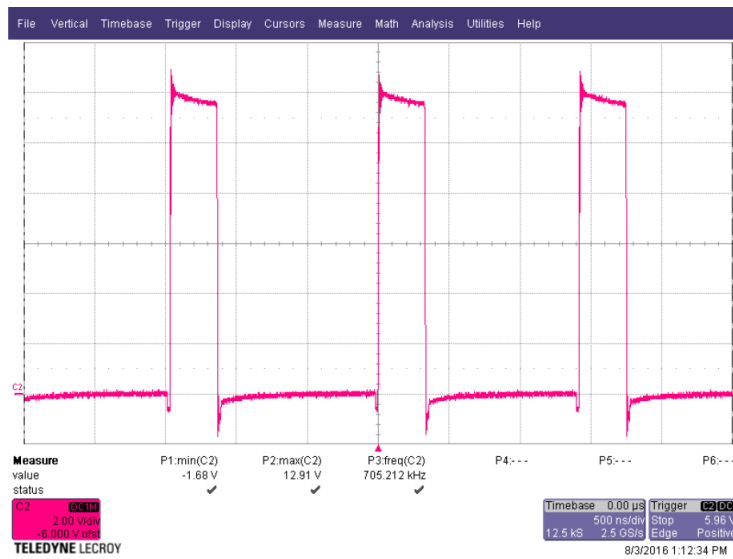

Figure 14. Switch Node Waveform – Layout 2

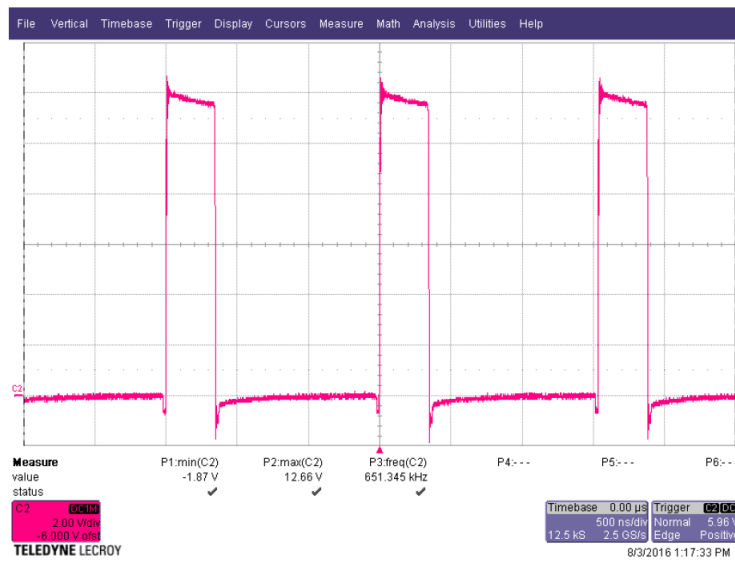

Figure 15. Switch Node Waveform – Layout 3

3.4 Results – Thermal Performance

Thermal images of each circuit were recorded with the converter running at 2.5-A continuous output. Layout 1 was measured from above. For the other two layouts, the PCB was inverted to simulate a typical PCB topology where the inductor (being the highest component) would be on the top of the PCB with IC on the bottom. The thermal image of the inductor side was recorded from above; with the IC side recorded from below, looking up.



Figure 16. Layout 1 - IC and Inductor Topside

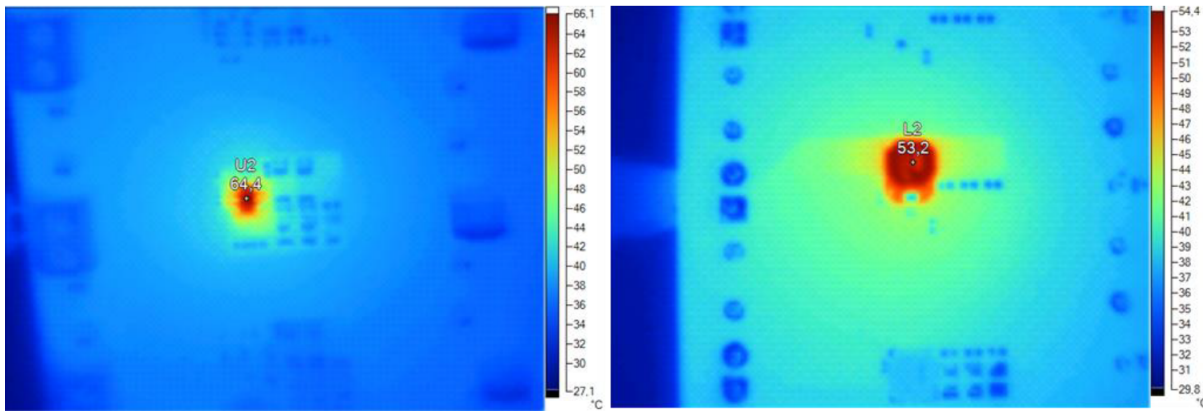

Figure 17. Layout 2 - IC Bottom Side (Left) Inductor Topside (Right)

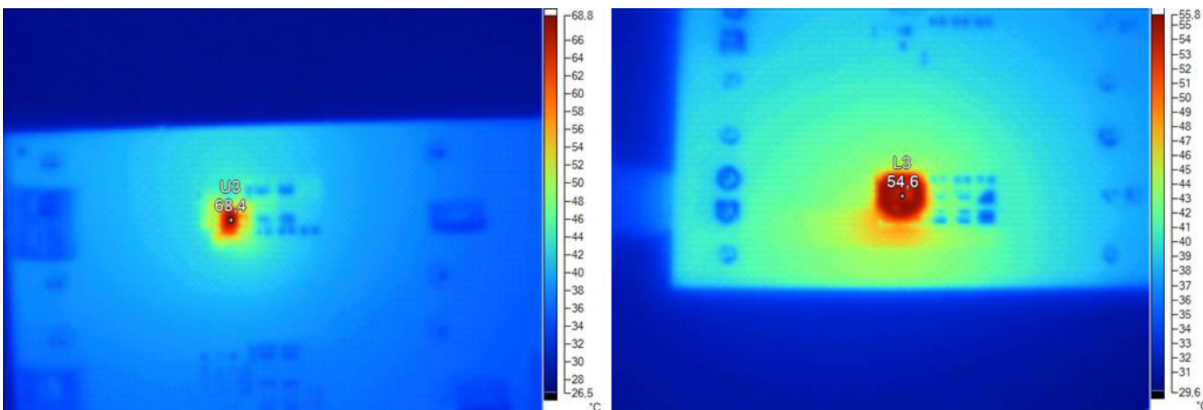

Figure 18. Layout 3 - IC Bottom Side (Left) Inductor Topside (Right)

The two-sided layouts appear to run cooler than the single-sided layout. This is most likely to be due to the co-heating of the inductor and IC when placed side by side.

4 Conclusions

Table 1 shows a summary of results for this investigation. Using both sides of the PCB for components, with the inductor or inductor and output capacitors on the opposite side to the IC, significantly reduces the PCB area used. The electrical effects of this smaller layout seem to be minimal. In fact, the double-sided layout may perform better. Output ripple and temperature appear to be lower for a double sided layout.

Table 1. Summary of Results

	Area (mm ²)	Output Ripple pk-pk (mV)	Input Ripple pk-pk (mV)	Switch Node Overshoot/Undershoot (V/V)	IC Temp./ Inductor Temp. (°C/°C)
Layout 1: Single sided	173	45	96	0.98/–2.06	73.8/57.1
Layout 2: Inductor on bottom	141	32	90	0.91/–1.68	64.4/53.2
Layout 3: Inductor + output capacitors on bottom	105	24	100	0.66/–1.87	68.4/54.6

Where space is at a premium, using both sides of the PCB to achieve a smallest-possible layout can be done without compromising electrical performance.

5 References

1. [DC/DC converter PCB layout, Part 1,2&3](#). Timothy Hegarty -June 15, 2015.
2. *Five steps to a great PCB layout for a step-down converter* Chris Glaser, TI Analog Applications Journal, 1Q2015. (SLYT614).
3. *How You Measure Ripple Can Make You or Break You*. George Lakkas, TI Powerhouse Blog, July 2016.

IMPORTANT NOTICE

Texas Instruments Incorporated and its subsidiaries (TI) reserve the right to make corrections, enhancements, improvements and other changes to its semiconductor products and services per JESD46, latest issue, and to discontinue any product or service per JESD48, latest issue. Buyers should obtain the latest relevant information before placing orders and should verify that such information is current and complete. All semiconductor products (also referred to herein as "components") are sold subject to TI's terms and conditions of sale supplied at the time of order acknowledgment.

TI warrants performance of its components to the specifications applicable at the time of sale, in accordance with the warranty in TI's terms and conditions of sale of semiconductor products. Testing and other quality control techniques are used to the extent TI deems necessary to support this warranty. Except where mandated by applicable law, testing of all parameters of each component is not necessarily performed.

TI assumes no liability for applications assistance or the design of Buyers' products. Buyers are responsible for their products and applications using TI components. To minimize the risks associated with Buyers' products and applications, Buyers should provide adequate design and operating safeguards.

TI does not warrant or represent that any license, either express or implied, is granted under any patent right, copyright, mask work right, or other intellectual property right relating to any combination, machine, or process in which TI components or services are used. Information published by TI regarding third-party products or services does not constitute a license to use such products or services or a warranty or endorsement thereof. Use of such information may require a license from a third party under the patents or other intellectual property of the third party, or a license from TI under the patents or other intellectual property of TI.

Reproduction of significant portions of TI information in TI data books or data sheets is permissible only if reproduction is without alteration and is accompanied by all associated warranties, conditions, limitations, and notices. TI is not responsible or liable for such altered documentation. Information of third parties may be subject to additional restrictions.

Resale of TI components or services with statements different from or beyond the parameters stated by TI for that component or service voids all express and any implied warranties for the associated TI component or service and is an unfair and deceptive business practice. TI is not responsible or liable for any such statements.

Buyer acknowledges and agrees that it is solely responsible for compliance with all legal, regulatory and safety-related requirements concerning its products, and any use of TI components in its applications, notwithstanding any applications-related information or support that may be provided by TI. Buyer represents and agrees that it has all the necessary expertise to create and implement safeguards which anticipate dangerous consequences of failures, monitor failures and their consequences, lessen the likelihood of failures that might cause harm and take appropriate remedial actions. Buyer will fully indemnify TI and its representatives against any damages arising out of the use of any TI components in safety-critical applications.

In some cases, TI components may be promoted specifically to facilitate safety-related applications. With such components, TI's goal is to help enable customers to design and create their own end-product solutions that meet applicable functional safety standards and requirements. Nonetheless, such components are subject to these terms.

No TI components are authorized for use in FDA Class III (or similar life-critical medical equipment) unless authorized officers of the parties have executed a special agreement specifically governing such use.

Only those TI components which TI has specifically designated as military grade or "enhanced plastic" are designed and intended for use in military/aerospace applications or environments. Buyer acknowledges and agrees that any military or aerospace use of TI components which have **not** been so designated is solely at the Buyer's risk, and that Buyer is solely responsible for compliance with all legal and regulatory requirements in connection with such use.

TI has specifically designated certain components as meeting ISO/TS16949 requirements, mainly for automotive use. In any case of use of non-designated products, TI will not be responsible for any failure to meet ISO/TS16949.

Products

Audio	www.ti.com/audio
Amplifiers	amplifier.ti.com
Data Converters	dataconverter.ti.com
DLP® Products	www.dlp.com
DSP	dsp.ti.com
Clocks and Timers	www.ti.com/clocks
Interface	interface.ti.com
Logic	logic.ti.com
Power Mgmt	power.ti.com
Microcontrollers	microcontroller.ti.com
RFID	www.ti-rfid.com
OMAP Applications Processors	www.ti.com/omap
Wireless Connectivity	www.ti.com/wirelessconnectivity

Applications

Automotive and Transportation	www.ti.com/automotive
Communications and Telecom	www.ti.com/communications
Computers and Peripherals	www.ti.com/computers
Consumer Electronics	www.ti.com/consumer-apps
Energy and Lighting	www.ti.com/energy
Industrial	www.ti.com/industrial
Medical	www.ti.com/medical
Security	www.ti.com/security
Space, Avionics and Defense	www.ti.com/space-avionics-defense
Video and Imaging	www.ti.com/video

TI E2E Community

e2e.ti.com