

Large Duty Cycle Operation With the TPS568230

ABSTRACT

The TPS568230 is an 8-A DC/DC synchronous buck converter with integrated FETs. The IC is based on Texas Instruments' proprietary D-CAP3™ control architecture and can support large duty cycle operation up to 97%. This application report introduces how the TPS568230 device is designed to implement large duty cycle operation, and how this feature improves load transient performance.

Contents

| | | |
|---|--|---|
| 1 | Introduction | 2 |
| 2 | TPS568230 Control Architecture | 2 |
| 3 | Large Duty Cycle Operation in the TPS568230 | 4 |
| 4 | Load Transient Performance Improvement on TPS568230..... | 7 |
| 5 | Summary..... | 9 |
| 6 | References | 9 |

List of Figures

| | | |
|----|--|---|
| 1 | Adaptive On-Time Control (AOT Control) | 2 |
| 2 | Detail D-CAP3™ Control Block Diagram in TPS568230 | 3 |
| 3 | Normal Operation Without On-Time Extension | 4 |
| 4 | One-time On-Time Extension ($1.2\text{ V} < V_{\text{IN}} / V_{\text{OUT}} \leq 1.6\text{ V}$) | 4 |
| 5 | Two-times On-Time Extension ($V_{\text{IN}} / V_{\text{OUT}} \leq 1.2\text{ V}$) | 4 |
| 6 | Normal Operation Without On-Time Extension | 6 |
| 7 | Normal Operation When F_{SW} Drops to 500 kHz | 6 |
| 8 | One-time On-Time Extension | 6 |
| 9 | One-time On-Time Extension | 6 |
| 10 | Two-times On-Time Extension | 6 |
| 11 | Two-times On-Time Extension | 6 |
| 12 | TPS568230 V_{IN} vs I_{O} Curve | 7 |
| 13 | Load Transient With On-Time Extension Triggered..... | 7 |
| 14 | Zoom in for Load Transient Glance | 7 |
| 15 | Load Transient From 0 A-4 A | 8 |
| 16 | Load Transient From 4 A-8 A | 8 |
| 17 | Load Transient From 1.6 A–6.4 A | 8 |

List of Tables

| | | |
|---|--|---|
| 1 | Detailed Summary for On-Time Extension | 5 |
| 2 | Bench Setup for TPS568230..... | 5 |
| 3 | Summary for TPS568230 On-Time Extension Bench Test | 5 |
| 4 | Duty Summary for TPS568230 | 7 |
| 5 | Summary for TPS568230EVM Load Transient Bench Test | 9 |

Trademarks

D-CAP3 is a trademark of Texas Instruments.
All other trademarks are the property of their respective owners.

1 Introduction

The TPS568230 device is a cost-effective, high-efficiency synchronous buck converter with integrated FETs. It uses D-CAP3™ control to provide fast transient response, good line and load regulation, has no requirement for external compensation, and supports low ESR output capacitors. The TPS568230 includes an on-time extension feature which can support large duty cycle operation up to 97%.

2 TPS568230 Control Architecture

The D-CAP3™ mode control architecture has an internal compensation circuit and combines Adaptive On-Time control (AOT control) for pseudo-fixed frequency operation.

2.1 Adaptive On-Time Control

Adaptive on-time control is a non-linear control architecture for buck regulators. At the beginning of each switching cycle, the high-side MOSFET is turned on (Figure 1). This MOSFET is turned off after an internal one shot timer expires. The ON time duration is set proportional to the output voltage, V_{OUT} , and inversely proportional to the converter input voltage, V_{IN} , to maintain a pseudo-fixed frequency over the input voltage operating range. The ON timer is reset and the high-side MOSFET is turned on again when the feedback voltage falls below the reference voltage.

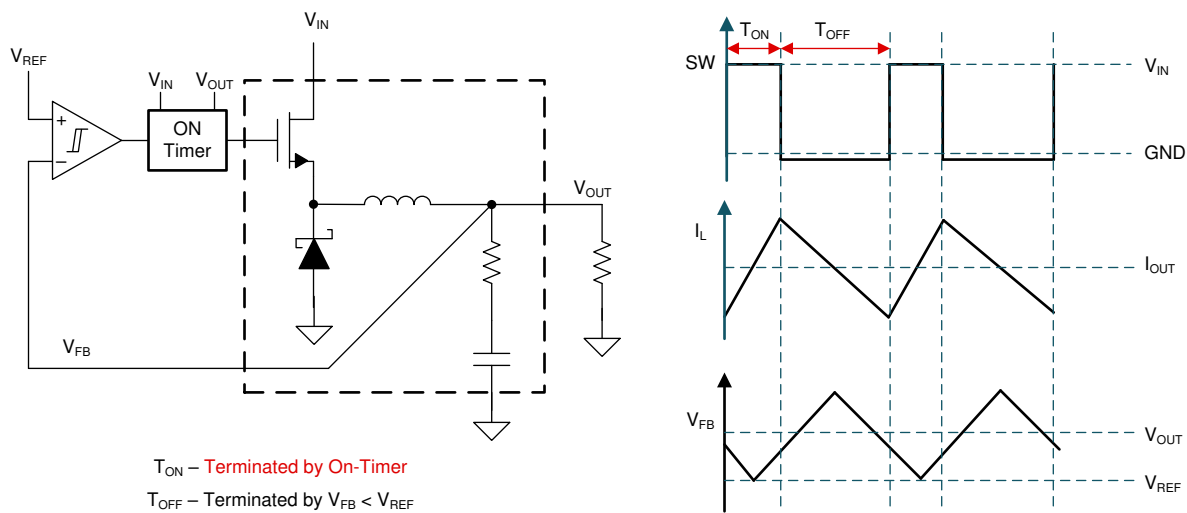

Figure 1. Adaptive On-Time Control (AOT Control)

In AOT control, the pseudo-fixed frequency is designed with the calculations in Equation 1 and Equation 2.

$$T_{ON} = D \times T_{SW} = \frac{V_{OUT}}{V_{IN} \times F_{SW}} \quad (1)$$

$$F_{SW} = \frac{1}{T_{SW}} \quad (2)$$

Based on Equation 1, if T_{ON} is adjusted with V_{OUT} and V_{IN} , the switching frequency F_{SW} will be constant. For the TPS568230 device, the switching frequency F_{SW} is selectable at 600 kHz, 800 kHz, or 1 MHz.

2.2 D-CAP3™ Control on TPS568230

Figure 2 shows the detailed control block diagram in the TPS568230 design.

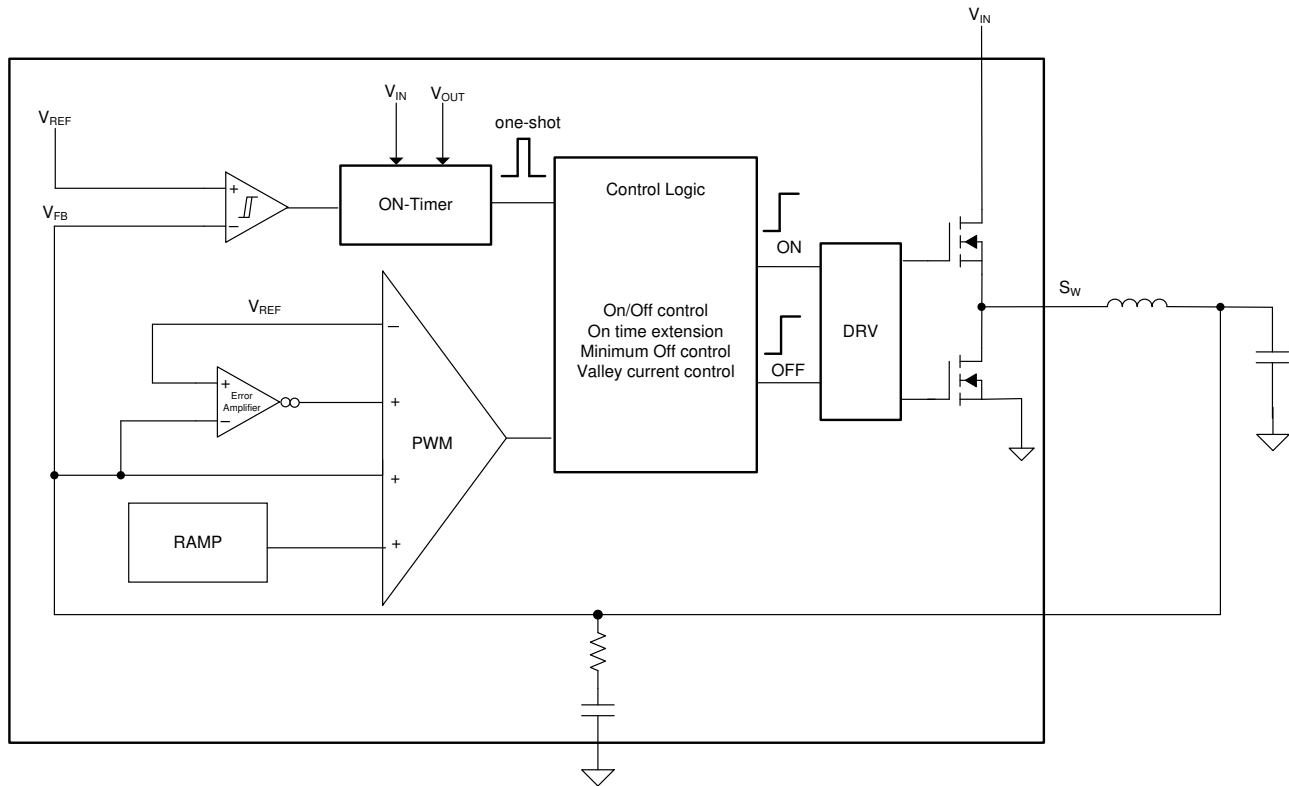

Figure 2. Detail D-CAP3™ Control Block Diagram in TPS568230

To improve noise immunity with virtually no ripple on the output voltage, an additional RAMP is added. An included error amplifier makes the output voltage very accurate.

In the control block of the TPS568230 device, the inductor valley current is monitored by measuring the SW node voltage during low-side MOSFET ON-time, which leads a minimum off time requirement for the high-side MOSFET. When the ON timer is expired, the high-side MOSFET is turned off and the low-side MOSFET is turned on. The turning off of the high-side MOSFET causes the SW ringing. When measuring the SW node voltage, a time delay needs to be included to let the internal SW node ringing dissipate. This time delay results in the minimum off time for the high-side MOSFET.

$$D = \frac{T_{ON}}{T_{SW}} = 1 - \frac{T_{OFF}}{T_{SW}} = 1 - F_{SW} \times T_{OFF} \quad (3)$$

Based on Equation 3, since T_{off} has a minimum value, it follows that the duty cycle, D , has a maximum value. If the F_{SW} is fixed, a smaller $T_{OFF(min)}$, means a larger duty cycle can be supported. Alternatively, if the $T_{OFF(min)}$ is fixed, a larger duty cycle can be supported with a smaller F_{SW} .

In the TPS568230 device, the maximum value of the minimum off time is 190 ns which results in a maximum duty cycle of about 85% during normal operation.

3 Large Duty Cycle Operation in the TPS568230

3.1 On-Time Extension Function

To support higher duty cycle operation, the TPS568230 includes an On-Time Extension function. This function operates by increasing the HSFET On-Time beyond that during normal operation, thus lowering the operating frequency and allowing large duty cycles to be maintained.

The On-Time Extension function is implemented in two stages:

- When the $1.2 < V_{IN}/V_{OUT} \leq 1.6$, and the V_{FB} is lower than internal V_{REF} , the T_{ON} will be extended one time interval. (Figure 4)
- When the $V_{IN}/V_{OUT} \leq 1.2$, and the V_{FB} is lower than internal V_{REF} , the T_{ON} will be extended two time intervals. (Figure 5)

Figure 3 shows waveforms during normal operation. Figure 4 and Figure 5 indicate when the On-Time Extension is triggered. It is obvious that the T_{ON} duration is longer when the On-Time Extension is activated.

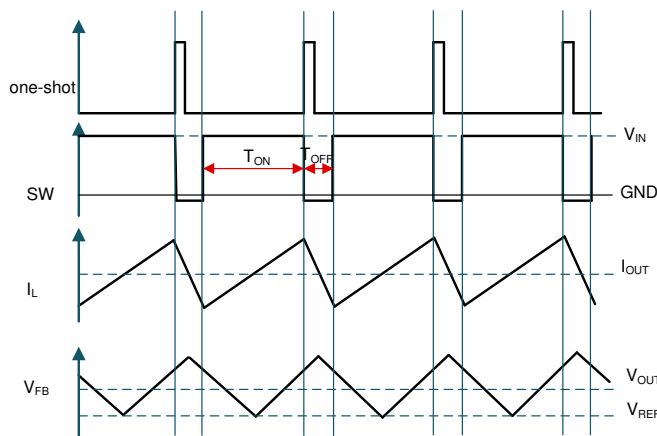

Figure 3. Normal Operation Without On-Time Extension

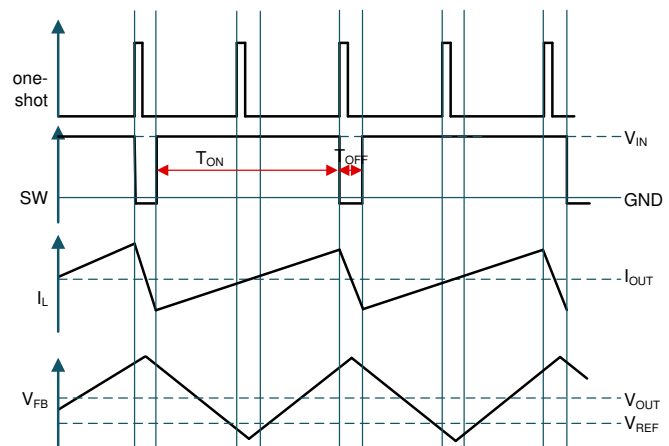

Figure 4. One-time On-Time Extension ($1.2 \text{ V} < V_{IN} / V_{OUT} \leq 1.6 \text{ V}$)

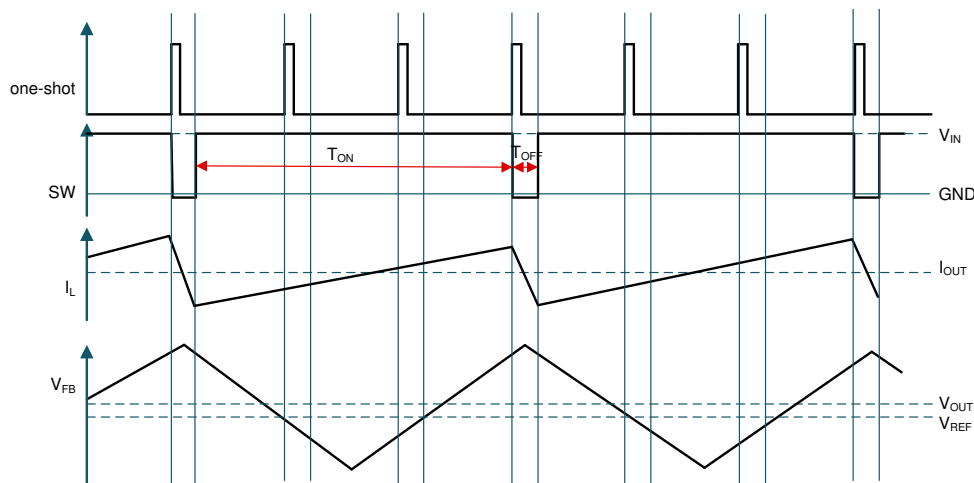

Figure 5. Two-times On-Time Extension ($V_{IN} / V_{OUT} \leq 1.2 \text{ V}$)

Table 1 shows the detailed summary. For the TPS568230 device, when the $V_{IN} / V_{OUT} \leq 1.2$, the switching frequency is designed to drop to about 500 kHz.

If the first On-Time Extension is triggered, the switching frequency is half of 500 kHz, which is 250 kHz.

If the second On-Time Extension is triggered, the switching frequency is one third of 500 kHz, which is 167 kHz.

Table 1. Detailed Summary for On-Time Extension

| V_{IN} / V_{OUT} Condition | V_{FB} | T_{ON} Condition | F_{SW} (kHz) |
|---|--|-----------------------------|----------------|
| Figure 3 $V_{IN} / V_{OUT} > 1.6$ | NA | Without On-time extension | 600 |
| Figure 4 $1.2 < V_{IN} / V_{OUT} \leq 1.6$ | V_{FB} is not lower than the internal V_{REF} when the ON-timer expires | Without On-time extension | 600 |
| | V_{FB} is lower than the internal V_{REF} when the ON-timer expires | One-time On-time extension | 300 |
| Figure 5 $V_{OUT} \leq 1.2$ | V_{FB} is not lower than the internal V_{REF} when the ON-timer expires | Without On-time extension | 500 |
| | V_{FB} is lower than the internal V_{REF} when the ON-timer expires the first time; but is not lower than internal V_{REF} when the ON-timer expires second time | One-time On-time extension | 250 |
| | V_{FB} is lower than internal V_{REF} when the ON-timer expires first time; and it is also lower than the internal V_{REF} when the ON-timer expires the second time | Two-times On-time extension | 167 |

3.2 TPS568230 EVM Bench Test

The bench tests are done on the TPS568230EVM. For details, see the [TPS568230EVM evaluation module User's Guide](#). The bench test setup and configuration is listed in [Table 2](#).

Table 2. Bench Setup for TPS568230

| V_{OUT} (V) | L (μ H) | C_{out} (μ F) | CFF (pF) / C15 | RFF (k Ω) / R14 | Rtop (k Ω) / R9 | Rbot (k Ω) / R8 | Mode |
|---------------|--------------|-----------------------------|----------------|-------------------------|-------------------------|-------------------------|----------------|
| 5 | 1.5 | 5 x 22 μ F (1206, 10 V) | 100 | 0 | 220 | 30 | FCCM / 600 kHz |

The waveforms in [Figure 6](#) to [Figure 11](#) show the behaviors with and without the ON-time extension function triggered. [Table 3](#) lists the summary for the figures.

Table 3. Summary for TPS568230 On-Time Extension Bench Test

| V_{OUT} (V) | Figure | I_{OUT} (A) | V_{IN} (V) | V_{IN} / V_{OUT} Condition | T_{ON} Condition | F_{SW} (kHz) |
|---------------|---------------------------|---------------|--------------|------------------------------|-----------------------------|----------------|
| 4.95 | Figure 6 | 8 | 12 | $V_{IN} / V_{OUT} > 1.6$ | Without ON-time extension | 600 |
| | Figure 7 | 8 | 5.8 | $V_{IN} / V_{OUT} \leq 1.2$ | Without ON-time extension | 500 |
| | Figure 8 | 0 | 5.3 | $V_{IN} / V_{OUT} \leq 1.2$ | One-time ON-time extension | 250 |
| | Figure 9 | 8 | 5.6 | $V_{IN} / V_{OUT} \leq 1.2$ | One-time ON-time extension | 250 |
| | Figure 10 | 0 | 5.1 | $V_{IN} / V_{OUT} \leq 1.2$ | Two-times ON-time extension | 167 |
| | Figure 11 | 8 | 5.5 | $V_{IN} / V_{OUT} \leq 1.2$ | Two-times ON-time extension | 167 |

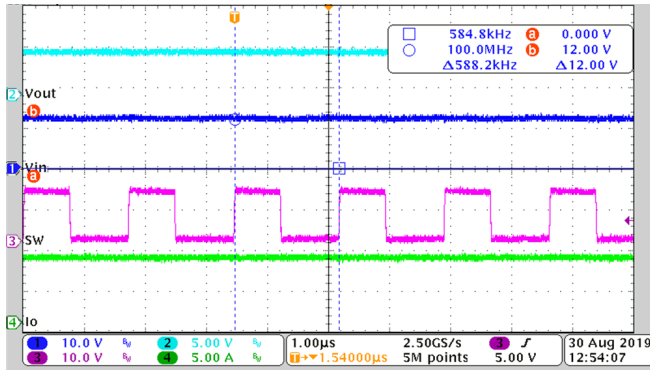

$V_{IN} = 12\text{ V}$, $V_{OUT} = 4.95\text{ V}$, $I_O = 8\text{ A}$

Figure 6. Normal Operation Without On-Time Extension

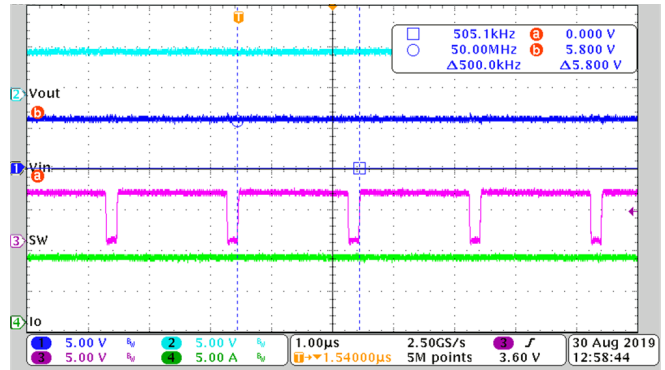

$V_{IN} = 5.8\text{ V}$, $V_{OUT} = 4.95\text{ V}$, $I_O = 8\text{ A}$

Figure 7. Normal Operation When F_{sw} Drops to 500 kHz

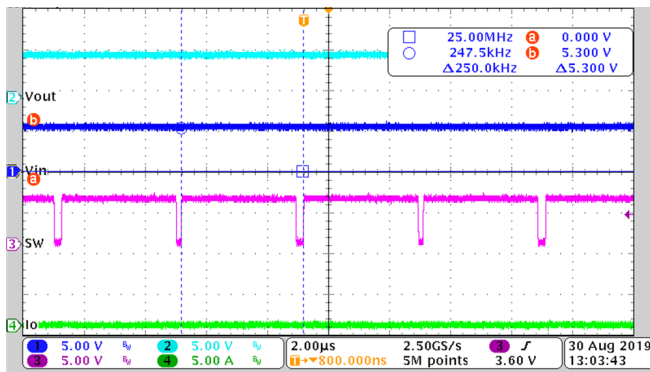

$V_{IN} = 5.3\text{ V}$, $V_{OUT} = 4.95\text{ V}$, $I_O = 0\text{ A}$

Figure 8. One-time On-Time Extension

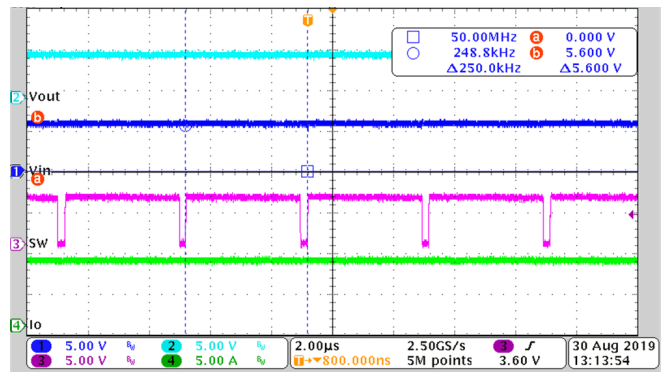

$V_{IN} = 5.6\text{ V}$, $V_{OUT} = 4.95\text{ V}$, $I_O = 8\text{ A}$

Figure 9. One-time On-Time Extension

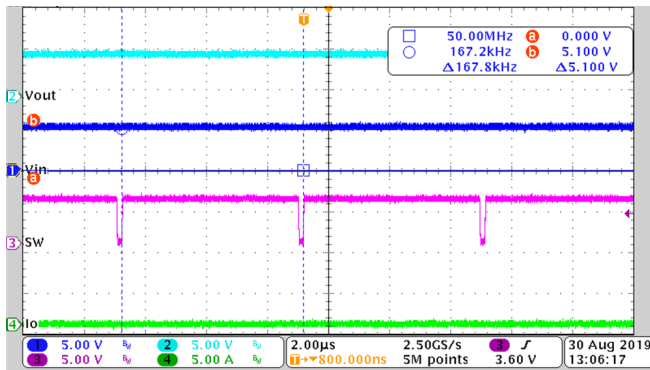

$V_{IN} = 5.1\text{ V}$, $V_{OUT} = 4.95\text{ V}$, $I_O = 0\text{ A}$

Figure 10. Two-times On-Time Extension

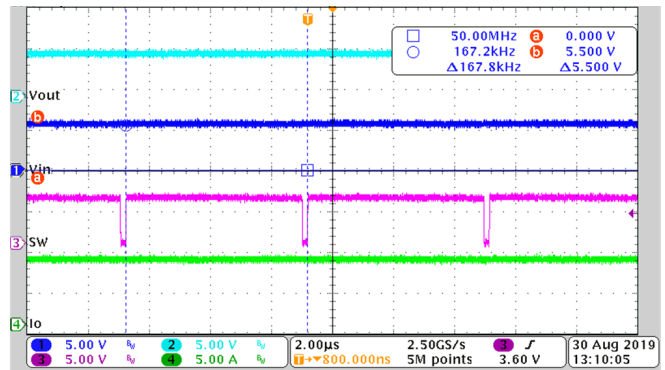

$V_{IN} = 5.5\text{ V}$, $V_{OUT} = 4.95\text{ V}$, $I_O = 8\text{ A}$

Figure 11. Two-times On-Time Extension

3.3 Summary for Bench Test Results

Based on the testing, without On-Time Extension triggered, the maximum duty is 85.3% under full loading. With the On-Time Extension triggered, the maximum duty is up to 90% under full loading.

Table 4. Duty Summary for TPS568230

| Loading | Max Duty (%) | |
|---------|----------------------------|-----------------------------|
| | One-time On-Time Extension | Two-times On-Time Extension |
| 0 A | 93.4 | 97 |
| 8 A | 88.4 | 90 |

With On-Time Extension triggered, when loading is added to 8 A, the maximum duty cycle drops. This is caused mainly by the power loss of the $R_{DS(ON)}$ of the HSFET and LSFET, and the power loss of the DCR of the external inductor.

Figure 12 provides a load vs maximum duty relationship for the TPS568230 device.

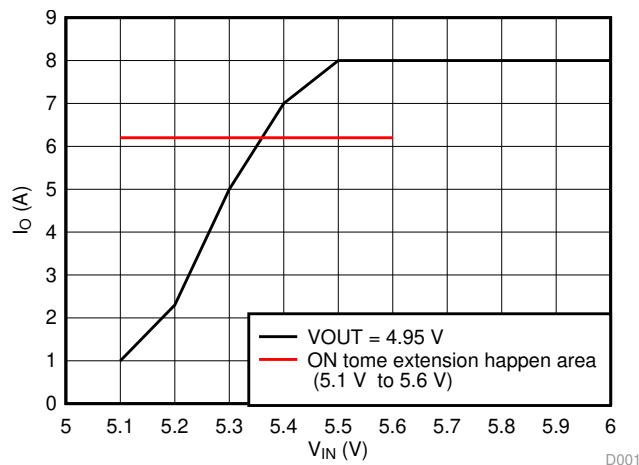

Figure 12. TPS568230 V_{IN} vs I_O Curve

4 Load Transient Performance Improvement on TPS568230

4.1 Load Transient Improvement by On-Time Extension

In addition to improving line dropout performance, the On-Time Extension function also improves load transient response. Figure 13 and Figure 14 indicate test results of the TPS568230 EVM module. The setup is the same as previously indicated with work mode settings for ECO / 600 kHz. The figures show the undershoot improvement during a light load to heavy load transient.

Figure 13 shows the V_{IN} 7.4 V, V_{OUT} 5-V load transient waveform from 0 A to 8 A, the slew rate is 2.5 A / μ s.

Figure 14 is the zoom in waveform for the instant the load transient happens.

When the load changes from 0 A to 8 A, the V_{IN} will drop about 1.5 V to be about 6 V, this will allow the two times On-Time Extension. From Figure 8, the SW signal indicates both a two-times ON-time extension, followed by a one-time On-Time Extension. With this longer HSFET ON, compared with non-On Time Extension, more energy is charged to the output to make the V_{OUT} voltage drop less than when the load change happens.

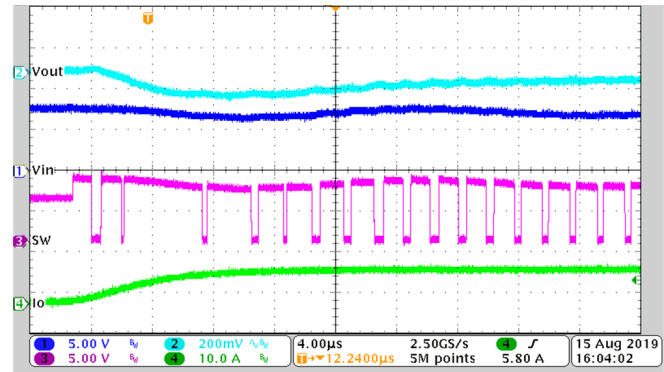
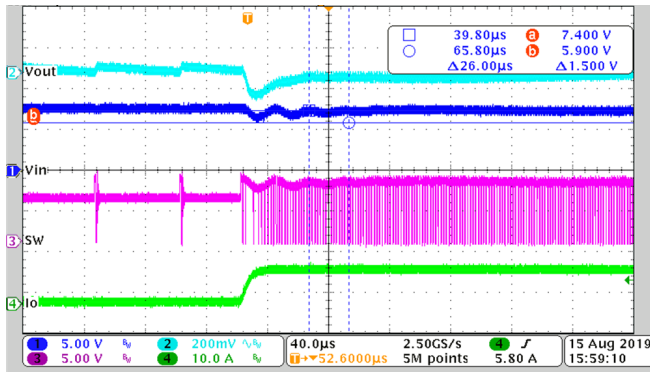

4.2 Bench Test Result of Load Transient in TPS568230

Based on Section 4.1, with the On-Time Extension function, the load transient performance is improved for undershoot especially with a large duty operation. Figure 15 and Figure 17 show the load transient performance for 6 V V_{IN} to 5 V V_{OUT} in the TPS568230EVM. The EVM test setup is the same as with Table 2.

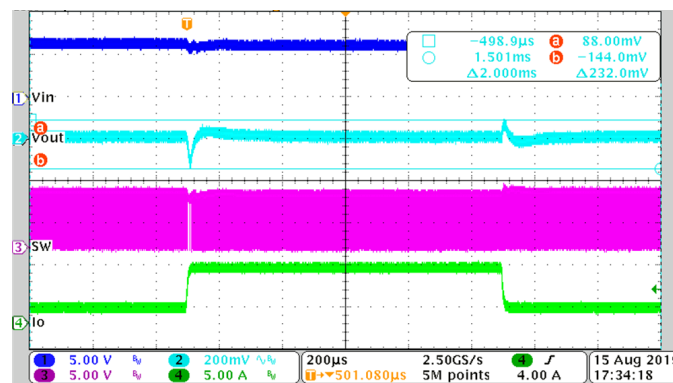
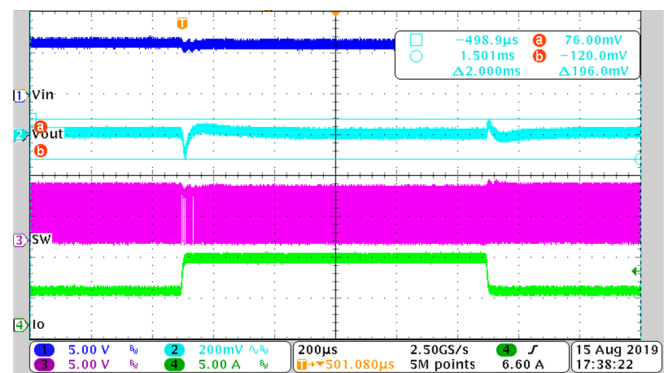
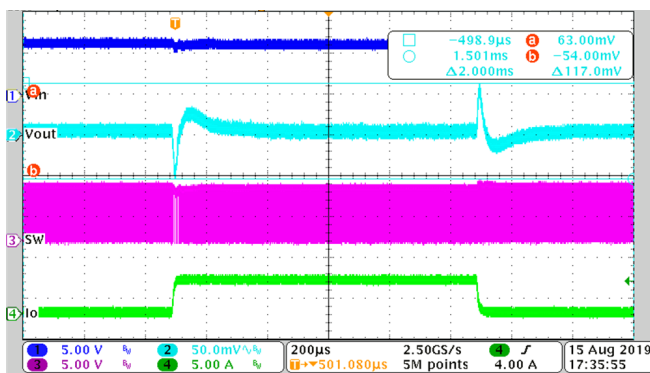

[Table 5](#) is the summary for the bench result, and it clearly shows a better load transient performance.

Table 5. Summary for TPS568230EVM Load Transient Bench Test

| V _{IN} | V _{OUT} | Slew Rate | Load Transient Test Results | | |
|-----------------|------------------|------------|-----------------------------|-----------------|-----------------|
| | | | 0–4 A | 4 A–8 A | 1.6 A–6.4 A |
| 6 | 4.95 | 2.5 A / us | –1.09% to 1.27% | –2.42% to 1.53% | –2.90% to 1.78% |

5 Summary

The TPS568230 device is designed with the On-Time Extension function and can support large duty cycle operation up to 97%. With this improvement, load transient performance is also improved.

6 References

1. Texas Instruments, [TPS568230 4.5-V to 18-V Input, 8-A Synchronous Step-Down Voltage Regulator Data Sheet](#)
2. Texas Instruments, [TPS56C230 4.5-V to 18-V, 12-A Synchronous Step-Down Converter Data Sheet](#)
3. Texas Instruments, [TPS568230EVM evaluation module User's Guide](#)
4. Texas Instruments, [TPS56C230EVM 12-A, Regulator Evaluation Module User's Guide](#)

6.1 Also From TI

The TPS56C230 device is a 12-A, synchronous step-down voltage regulator with an input range of 4.5 V to 18 V. It includes the same ON-time extension function. With a 500-kHz switching frequency and 180-ns minimum off time, it can support large duty cycle operation up to 97%. As with the TPS568230 device, the load transient performance is improved a lot by involving the ON-time extension feature.

IMPORTANT NOTICE AND DISCLAIMER

TI PROVIDES TECHNICAL AND RELIABILITY DATA (INCLUDING DATASHEETS), DESIGN RESOURCES (INCLUDING REFERENCE DESIGNS), APPLICATION OR OTHER DESIGN ADVICE, WEB TOOLS, SAFETY INFORMATION, AND OTHER RESOURCES "AS IS" AND WITH ALL FAULTS, AND DISCLAIMS ALL WARRANTIES, EXPRESS AND IMPLIED, INCLUDING WITHOUT LIMITATION ANY IMPLIED WARRANTIES OF MERCHANTABILITY, FITNESS FOR A PARTICULAR PURPOSE OR NON-INFRINGEMENT OF THIRD PARTY INTELLECTUAL PROPERTY RIGHTS.

These resources are intended for skilled developers designing with TI products. You are solely responsible for (1) selecting the appropriate TI products for your application, (2) designing, validating and testing your application, and (3) ensuring your application meets applicable standards, and any other safety, security, or other requirements. These resources are subject to change without notice. TI grants you permission to use these resources only for development of an application that uses the TI products described in the resource. Other reproduction and display of these resources is prohibited. No license is granted to any other TI intellectual property right or to any third party intellectual property right. TI disclaims responsibility for, and you will fully indemnify TI and its representatives against, any claims, damages, costs, losses, and liabilities arising out of your use of these resources.

TI's products are provided subject to TI's Terms of Sale (www.ti.com/legal/termsofsale.html) or other applicable terms available either on ti.com or provided in conjunction with such TI products. TI's provision of these resources does not expand or otherwise alter TI's applicable warranties or warranty disclaimers for TI products.

Mailing Address: Texas Instruments, Post Office Box 655303, Dallas, Texas 75265
Copyright © 2020, Texas Instruments Incorporated