

TPS629203 Buck Converter Evaluation Module User's Guide



ABSTRACT

The TPS629203EVM is designed to help user easily evaluate the performance of TPS629203. The user's guide includes the following:

- Performance characteristics
- EVM configuration
- Test setup
- Test result
- PCB layout
- Schematic diagram
- Bill of materials

Table of Contents

1 Introduction	2
2 Performance Specification	2
3 EVM Configuration and Modification	3
3.1 Input and Output Capacitors.....	3
3.2 Configurable Enable Threshold Voltage.....	3
3.3 MODE/S-CONF Setting.....	3
3.4 Power Good.....	3
3.5 Power Good Pullup Voltage.....	3
3.6 Feedforward Capacitor Option.....	3
3.7 Output Voltage Setting.....	4
3.8 Loop Response Measurement.....	4
4 EVM Test Setup	5
4.1 Input and Output Connectors.....	5
4.2 Jumper Configuration.....	5
5 Test Results	6
6 Board Layout	12
7 Schematic and Bill of Materials	15
7.1 Schematic.....	15
7.2 Bill of Materials.....	15
8 References	16

Trademarks

All trademarks are the property of their respective owners.

1 Introduction

The TPS629203 is a high-efficiency and highly flexible synchronous step-down buck converter in a small 1.6-mm × 2.1-mm SOT583 package. The TPS629203 can be configured to run 2.5 MHz or 1 MHz in either forced PWM mode or auto PFM/PWM mode. In 2.5-MHz auto PFM/PWM mode, TI AEE mode automatically adjusts the switching frequency based on both input and output voltage to hold a high efficiency through the whole operation range without the need of using different inductors. The device includes a Mode/S-CONF input to select different combinations of following:

- External/internal feedback
- Max switching frequency
- Output discharge enable/disable
- Auto PFM/PWM(with AEE) and forced PWM operations

The TPS629203EVM(BSR131-007) uses a 300-mA TPS629203 converter to produce 3.3-V output from a 12-V input.

2 Performance Specification

Table 2-1 provides a summary of the TPS629203EVM performance specifications. All the specifications are given at an ambient temperature of 25°C.

Table 2-1. TPS629203EVM Performance Specification Summary

Specification	Test Conditions	MIN	TYP	MAX	UNIT
Input voltage		5	12	17	V
Output voltage			3.3		V
Output current		0		300	mA
Input current	$V_{IN} = 12\text{ V}$, $V_{OUT} = 3.3\text{ V}$, $I_{OUT} = 0\text{ A}$, forced PWM, 2.5 MHz, 3.3- μH inductor		5.7		mA
	$V_{IN} = 12\text{ V}$, $V_{OUT} = 3.3\text{ V}$, $I_{OUT} = 300\text{ mA}$, forced PWM, 2.5 MHz, 3.3- μH inductor		0.0928		A
Switching frequency	Set by the Mode/S-CONF pin		2.5		MHz
Line regulation	$V_{IN} = 5\text{ V}–17\text{ V}$, $V_{OUT} = 3.3\text{ V}$, $I_{OUT} = 0\text{ A}$ and 300 mA, forced PWM, 2.5/1 MHz, VSET, 3.3- μH inductor		+0.5%, –0.2%		
Load regulation	$V_{IN} = 12\text{ V}$, $V_{OUT} = 3.3\text{ V}$, $I_{OUT} = 0\text{ A}–300\text{ mA}$, forced PWM and auto PFM/PWM with AEE, 2.5/1 MHz, VSET, 3.3- μH inductor		+0.7%, –0.2%		
Output ripple	$V_{IN} = 12\text{ V}$, $V_{OUT} = 3.3\text{ V}$, $I_{OUT} = 300\text{ mA}$, forced PWM, 2.5 MHz, 3.3- μH inductor		10		mV
Peak efficiency	$V_{IN} = 12\text{ V}$, $V_{OUT} = 3.3\text{ V}$, $I_{OUT} = 0\text{ A}–300\text{ mA}$, forced PWM, 2.5 MHz, 3.3- μH inductor		89.74%		
	$V_{IN} = 12\text{ V}$, $V_{OUT} = 3.3\text{ V}$, $I_{OUT} = 0\text{ A}–300\text{ mA}$, auto PFM/PWM with AEE, 2.5 MHz, 3.3- μH inductor		90.31%		
	$V_{IN} = 12\text{ V}$, $V_{OUT} = 3.3\text{ V}$, $I_{OUT} = 10\text{ mA}$, auto PFM/PWM with AEE, 2.5 MHz, 3.3- μH inductor		84.66%		
Output rise time	$V_{IN} = 12\text{ V}$, $V_{OUT} = 3.3\text{ V}$, $I_{OUT} = 300\text{ mA}$, forced PWM, 2.5 MHz, 3.3- μH inductor		500		μs
Load transient	$V_{IN} = 12\text{ V}$, $V_{OUT} = 3.3\text{ V}$, $I_{OUT} = 100\text{ mA}–300\text{ mA}$, slew rate: 1 A/ μs , forced PWM, VSET, 2.5 MHz, 3.3- μH inductor		± 21		mV
Loop bandwidth	$V_{IN} = 12\text{ V}$, $V_{OUT} = 3.3\text{ V}$, $I_{OUT} = 300\text{ mA}$, forced PWM, VSET, 2.5 MHz, 3.3- μH inductor		93.9		kHz
Phase margin	$V_{IN} = 12\text{ V}$, $V_{OUT} = 3.3\text{ V}$, $I_{OUT} = 300\text{ mA}$, forced PWM, VSET, 2.5 MHz, 3.3- μH inductor		84.3		deg
IC case temperature	$V_{IN} = 12\text{ V}$, $V_{OUT} = 3.3\text{ V}$, $I_{OUT} = 300\text{ mA}$, forced PWM, 2.5 MHz, 3.3- μH inductor, 10 minutes soaking		28.8		°C

3 EVM Configuration and Modification

The EVM is designed to provide access to features of the TPS629203. The EVM also provides jumpers for different configurations. Jumper selections must be made prior to enabling the TPS629203. Additional input and output capacitors can be added. The input voltage at which the IC turns on can be programmed with a voltage divider. The TPS629203EVM allows multiple MODE/S-CONF pin configurations. The loop response can also be measured.

3.1 Input and Output Capacitors

C2 is provided for additional input capacitance. This capacitor is not required for proper operation but can be used to reduce the input voltage ripple. C6, C7, C8, and C9 are provided for additional output capacitors. These capacitors are not required for proper operation but can be used to reduce the output voltage ripple. The total output capacitance must remain within the recommended range for TPS629203.

3.2 Configurable Enable Threshold Voltage

JP1 is provided as option for Enable pin with precise threshold voltage. R4 and R5 can be adjusted to set a user-selectable input voltage at which the IC turns on. The EVM pre-configured R4 and R5 to have 6.5-V rising and 5.85-V falling threshold voltage.

3.3 MODE/S-CONF Setting

JP2 is used to set different MODE/S-CONF configurations. MODE/S-CONF can be connected to VIN and GND as a traditional HIGH or LOW level. R6 and R7 select the other device configurations including the following:

- Internal/external feedback
- Switching frequency
- Output discharge
- Auto PFM/PWM or forced PWM options

The values of R6 and R7 can be changed per the user's requirement.

- While using the internal feedback (VSET) configuration for the output voltage setting, either float the FB pin by cutting the net tie (NT1) included on the back of the board or remove both R1 and R2 for 3.3-V output voltage. Other output voltage can be programmed by removing R1 and changing the value of R2. Ensure the JP2 jumper is placed correctly for proper operation with internal feedback.

WARNING

Do not set the MODE/S-CONF pin for external feedback if either the net tie (NT1) is cut or R1 and R2 are removed. This can cause damage to the device due to lack of external feedback control.

- Dynamic mode option is an advanced feature that allows the MODE/S-CONF pin to actively switch between forced PWM and auto PFM/PWM during operation, but this is only possible by driving the MODE/S-CONF pin between VIN and GND. This feature provides the user with the option of controlling if and when the device enters power save mode (DCM).

3.4 Power Good

JP3 is provided as an option for power-good test point. If power good is not used, it is recommended to tie to GND or leave open.

3.5 Power Good Pullup Voltage

JP4 is provided as an option for power-good pullup voltage. Either V_{IN} or V_{OUT} with a 100-k Ω pullup resistor.

3.6 Feedforward Capacitor Option

C10 is provided as an optional of feedforward capacitor (C_{FF}). It helps to improve the loop stability if needed. More detailed discussion on the optimization for stability versus transient response can be found in the [Optimizing Transient Response of Internally Compensated dc-dc Converter With Feedforward Capacitor](#) and [Feedforward Capacitor to Improve Stability and Bandwidth With the TPS621-Family and TPS821-Family](#) application reports.

3.7 Output Voltage Setting

The TPS629203EVM is configured for external feedback as default with an output voltage of 3.3 V set by R1 and R2. Additionally, if the internal feedback (VSET) configuration is used, the user can cut net tie NT1 located on the back of the board (shown in Figure 3-1). This will float the FB pin, resulting in a 3.3-V output voltage using the internal VSET. Resistors R1 and R2 can also be changed to set the output voltage between 0.6 V and 5.5 V. See the TPS629203 data sheet for recommended values. R2 was populated with 34 k such that if the internal (VSET) is chosen while R1 is removed, the device will regulate to 1.8-V output voltage.

WARNING

If the output voltage is increased, ensure the voltage rating of output capacitor C5 is sized appropriately.

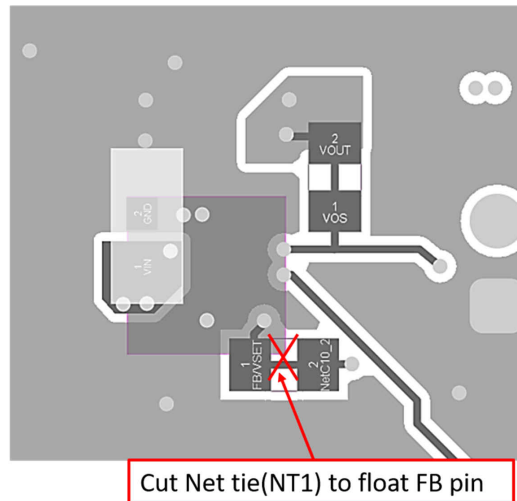

Figure 3-1. Internal Feedback (VSET) Configuration Board Modification

3.8 Loop Response Measurement

The loop response can be measured after simply changing to the board. First, cut net tie (NT2) and install a 10-Ω 0603 resistor on the bottom of board (shown in Figure 3-2). An AC signal (10-mV, peak-to-peak amplitude is recommended) can be injected into the control loop across the added 10-Ω resistor.

Cut Net tie(NT2) to install 10ohm resistor for bode plot measurement

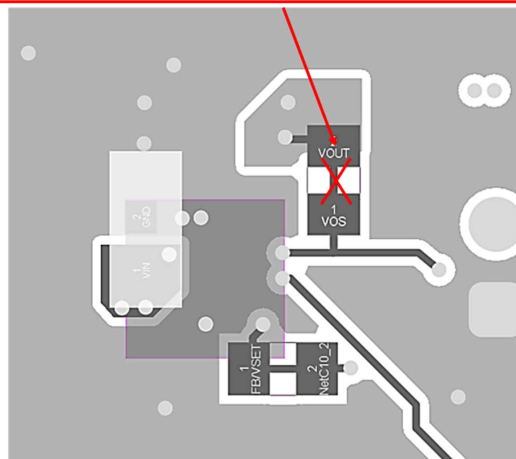

Figure 3-2. Bode Plot Measurement Board Modification

4 EVM Test Setup

This section describes how to properly test the EVM.

4.1 Input and Output Connectors

Table 4-1. Input and Output Connector

Connector	Pins	Description
J1	Pin 1 and Pin 2	V_{IN} positive input for input supply
	Pin 3 and Pin 4	S+ and S– input voltage sense. Input voltage measure points
	Pin 5 and Pin 6	GND return for input supply
J2	Pin 1 and Pin 2	V_{OUT} output voltage connection
	Pin 3 and Pin 4	S+ and S– output voltage sense. Output voltage measure points
	Pin 5 and Pin 6	GND output return connection

4.2 Jumper Configuration

4.2.1 JP1 Enable

Table 4-2. Enable Pin Configuration

Jumper Short Location	Description
Pin 2 and Pin 3	Turn on the device as default.
Pin 3 and Pin 4	Turn off the device.
Pin 1 and Pin 2, Pin 3 and Pin 4	Set the programmable Enable threshold voltage with R4 and R5.
Pin 3 and Pin 4	Pin1 can be used for external supply voltage with a R4 and R5 resistor divider.

4.2.2 JP2 MODE/S-CONF

Table 4-3. MODE/S-CONF Pin Configuration

Jumper Short Location	Description
Pin 1 and Pin 3	Forced PWM, 2.5 MHz, external FB, output discharge enabled
Pin 3 and Pin 5	Auto PFM/PWM with AEE, 2.5 MHz, external FB, output discharge enabled
Pin 2 and Pin 4	124 k to GND, forced PWM, 1 MHz, internal FB (VSET), output discharge disabled
Pin 4 and Pin 6	64.9 k to GND, auto PFM/PWM, 1 MHz, internal FB (VSET), output discharge enabled

4.2.3 JP3 Power Good

The PGOOD output is on pin 1 of this header with a convenient ground on pin 2. If PG is not used, short pin 1 and pin 2 by a jumper.

4.2.4 JP4 PG Pullup Voltage

Table 4-4. PG Pullup Voltage Option

Jumper Short Location	Description
Pin 1 and Pin 2	PG pulls up to the output voltage.
Pin 2 and Pin 3	PG pulls up to the input voltage.
No jumper	JP4 pin 2 can pull up to a different external voltage. This external voltage must remain below 18 V.

5 Test Results

This section provides the test results of the TPS629203EVM.

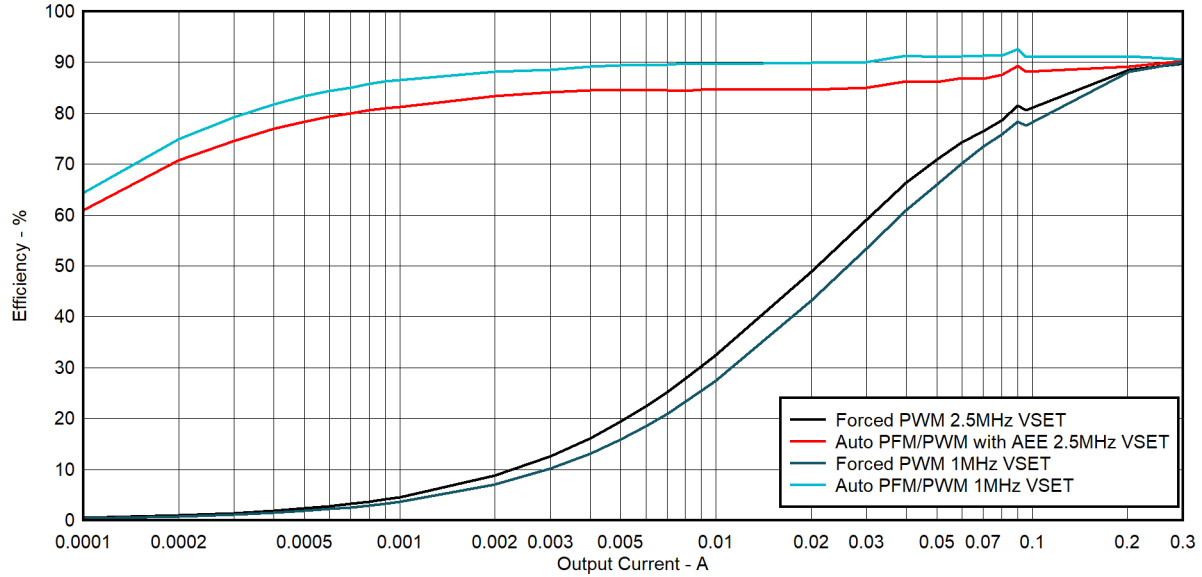

Figure 5-1. Efficiency, $V_{IN} = 12\text{ V}$, $V_{OUT} = 3.3\text{ V}$, $F_{SW} = 2.5\text{ MHz}$ and 1 MHz

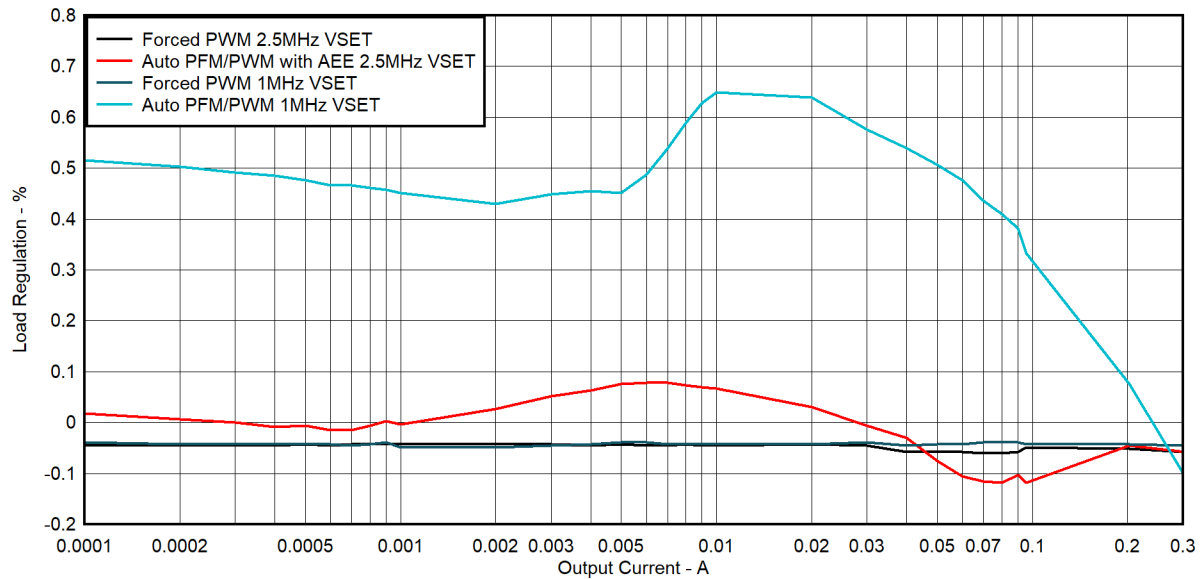

Figure 5-2. Load Regulation, $V_{IN} = 12\text{ V}$, $V_{OUT} = 3.3\text{ V}$, $F_{SW} = 2.5\text{ MHz}$ and 1 MHz

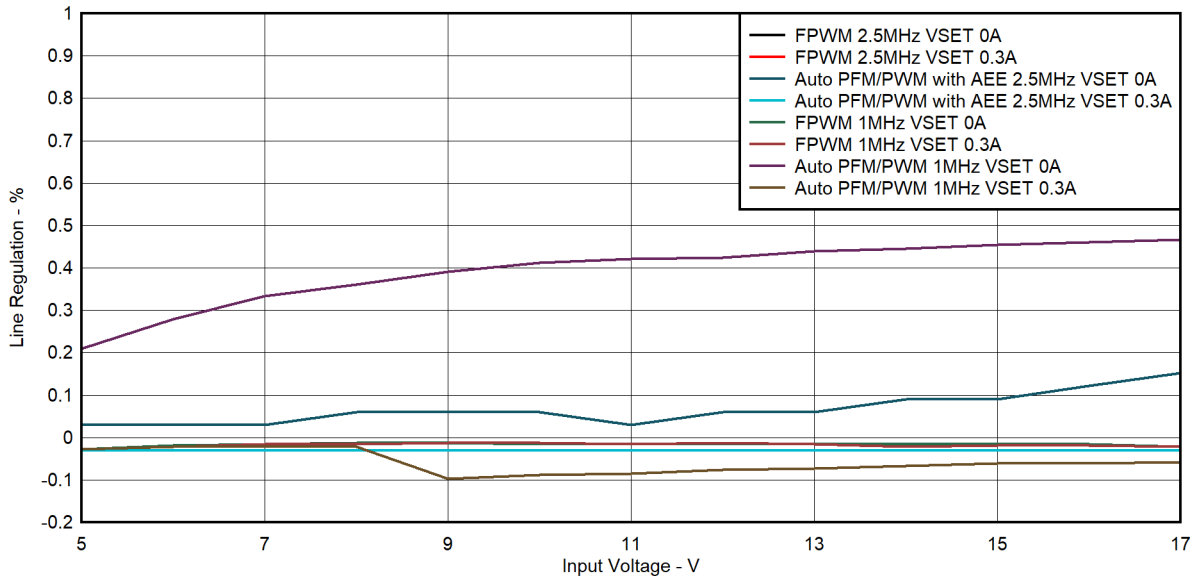

Figure 5-3. Line Regulation, $V_{IN} = 5\text{ V}–17\text{ V}$, $V_{OUT} = 3.3\text{ V}$, $I_{OUT} = 0\text{ A}$ and 300 mA , $F_{SW} = 2.5\text{ MHz}$ and 1 MHz

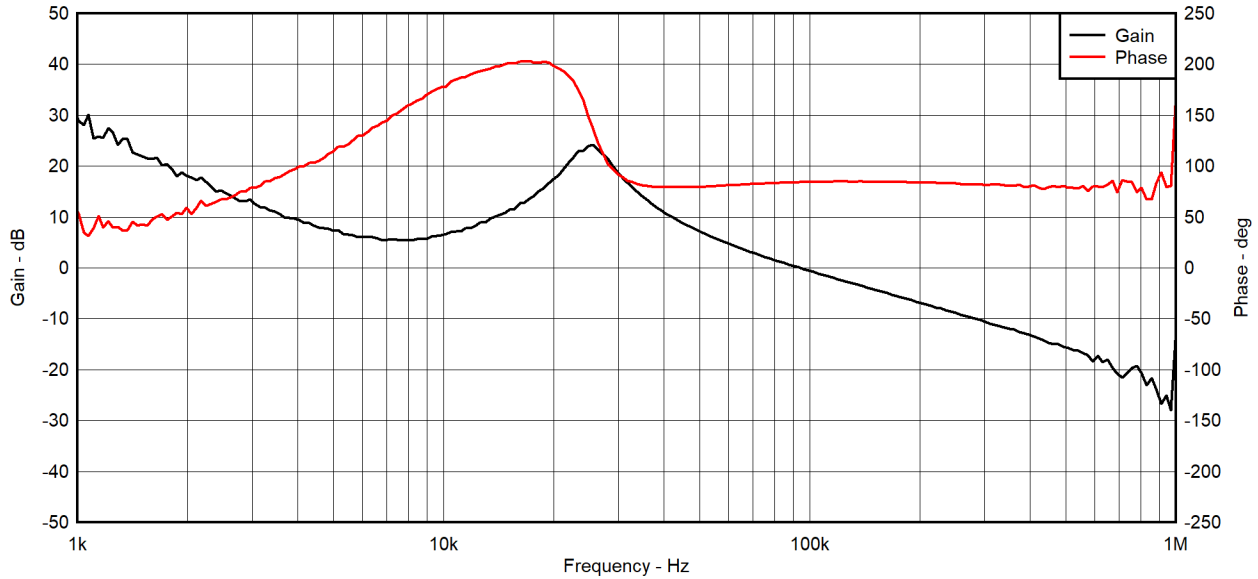

Figure 5-4. Loop Response Forced PWM VSET, $V_{IN} = 12\text{ V}$, $V_{OUT} = 3.3\text{ V}$, $I_{OUT} = 300\text{ mA}$

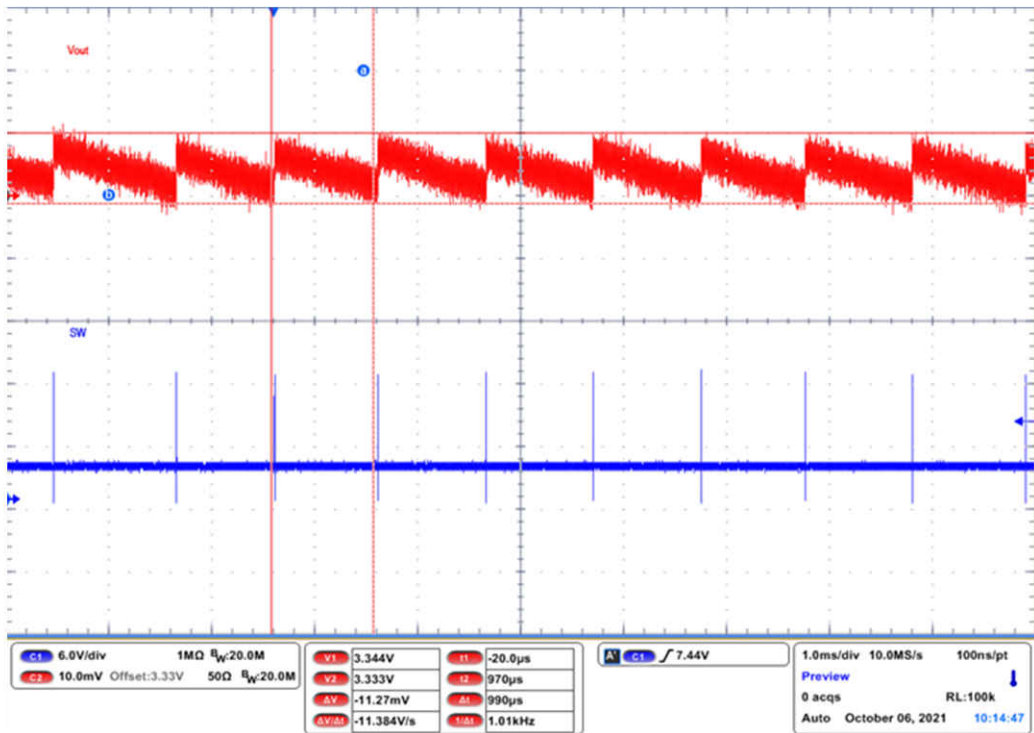

Figure 5-5. Output Voltage Ripple Auto PFM/PWM, $V_{IN} = 12\text{ V}$, $V_{OUT} = 3.3\text{ V}$, $I_{OUT} = 0\text{ A}$

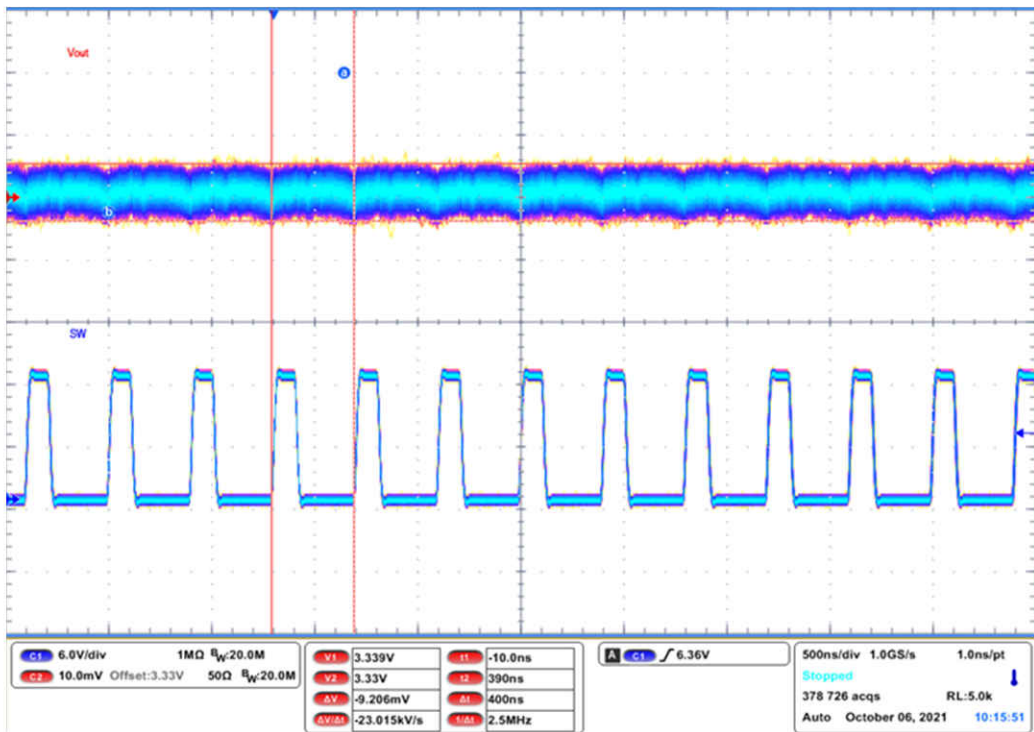

Figure 5-6. Output Voltage Ripple Forced PWM, $V_{IN} = 12\text{ V}$, $V_{OUT} = 3.3\text{ V}$, $I_{OUT} = 300\text{ mA}$

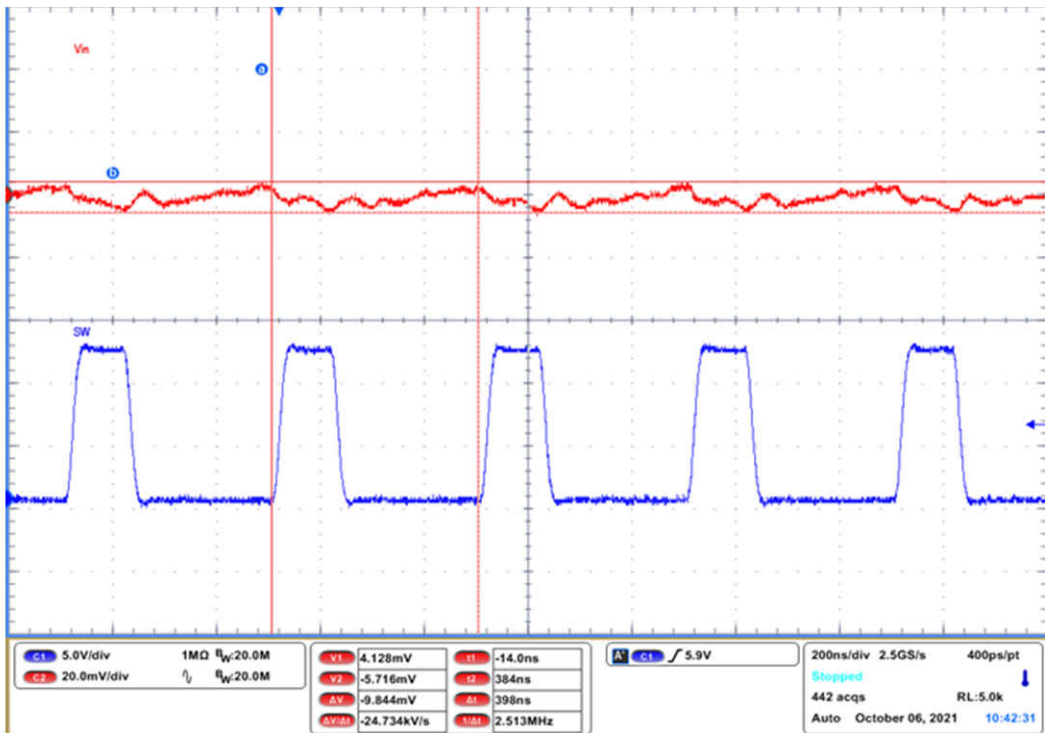

Figure 5-7. Input Voltage Ripple Forced PWM, $V_{IN} = 12\text{ V}$, $V_{OUT} = 3.3\text{ V}$, $I_{OUT} = 300\text{ mA}$

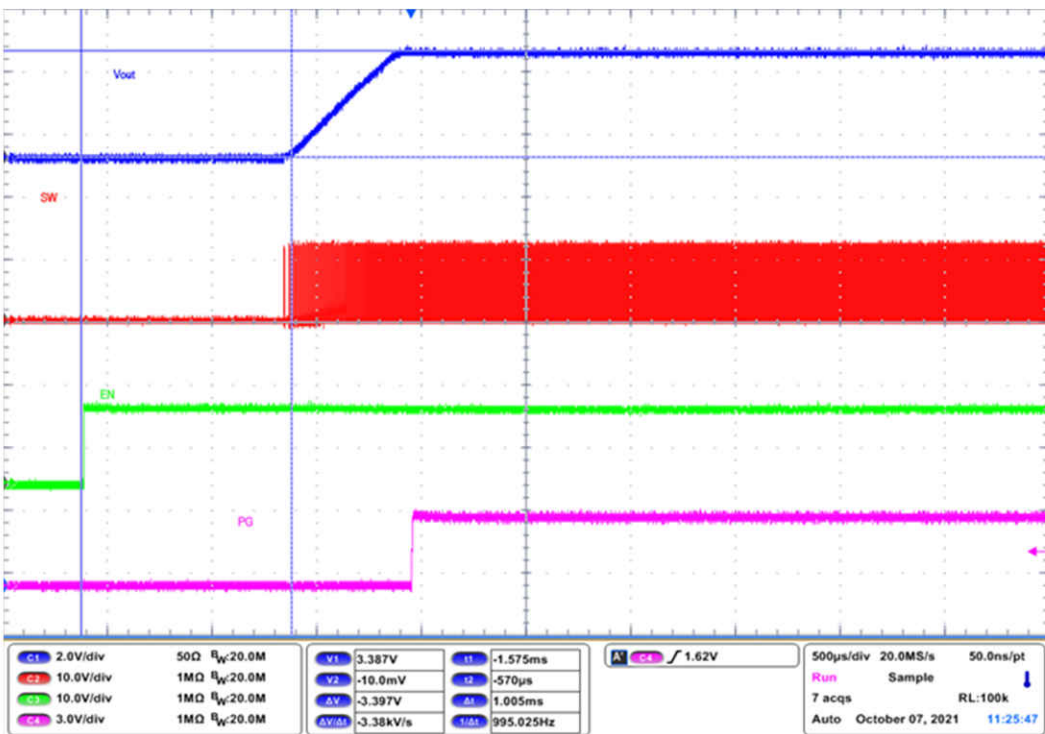

Figure 5-8. Enable Start-Up Forced PWM, $V_{IN} = 12\text{ V}$, $V_{OUT} = 3.3\text{ V}$, $I_{OUT} = 300\text{ mA}$

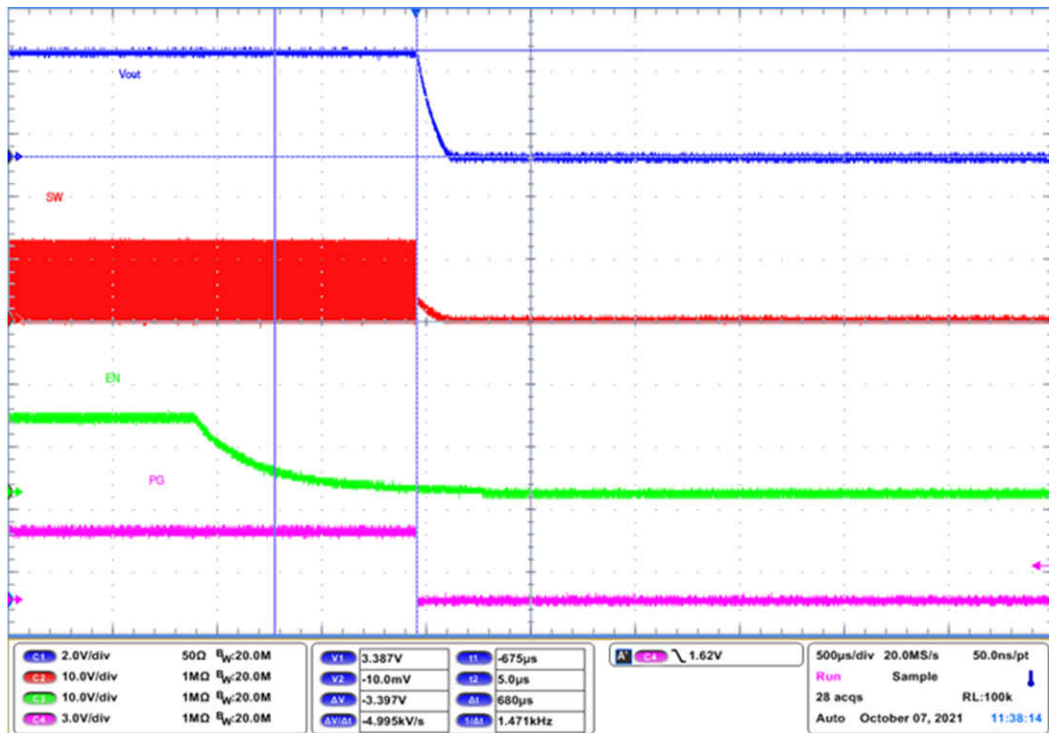

Figure 5-9. Enable Shutdown Forced PWM, $V_{IN} = 12\text{ V}$, $V_{OUT} = 3.3\text{ V}$, $I_{OUT} = 300\text{ mA}$

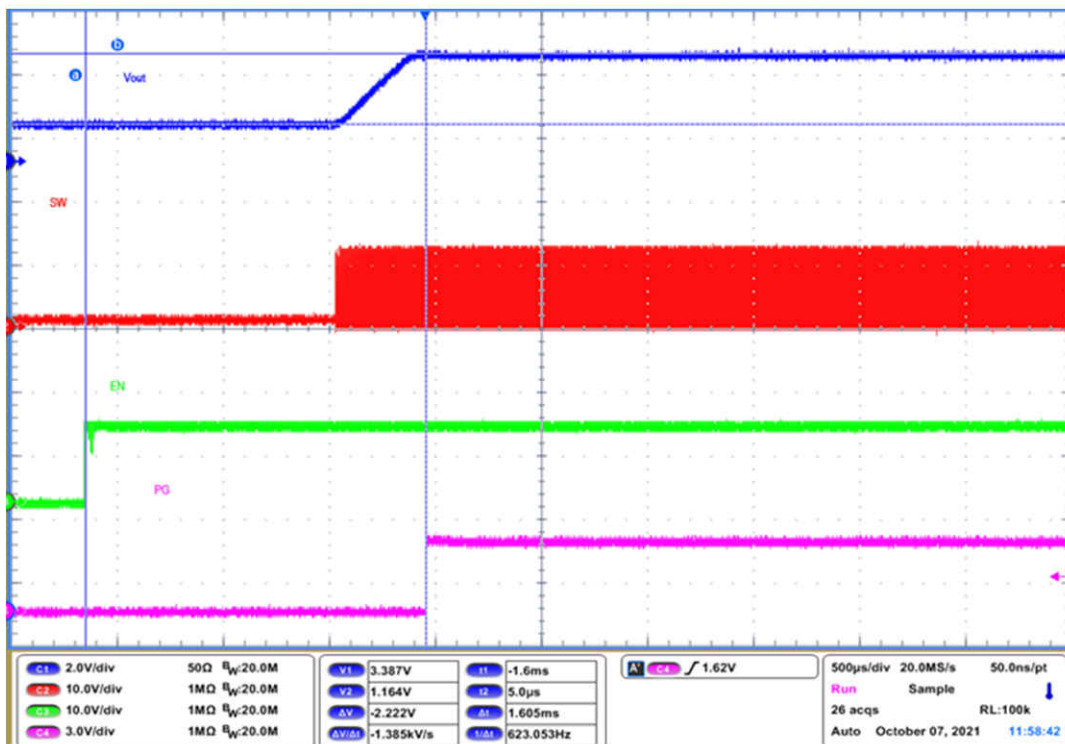

Figure 5-10. Enable Pre-Bias Start-Up Forced PWM, $V_{IN} = 12\text{ V}$, $V_{OUT} = 3.3\text{ V}$, $I_{OUT} = 0\text{ A}$

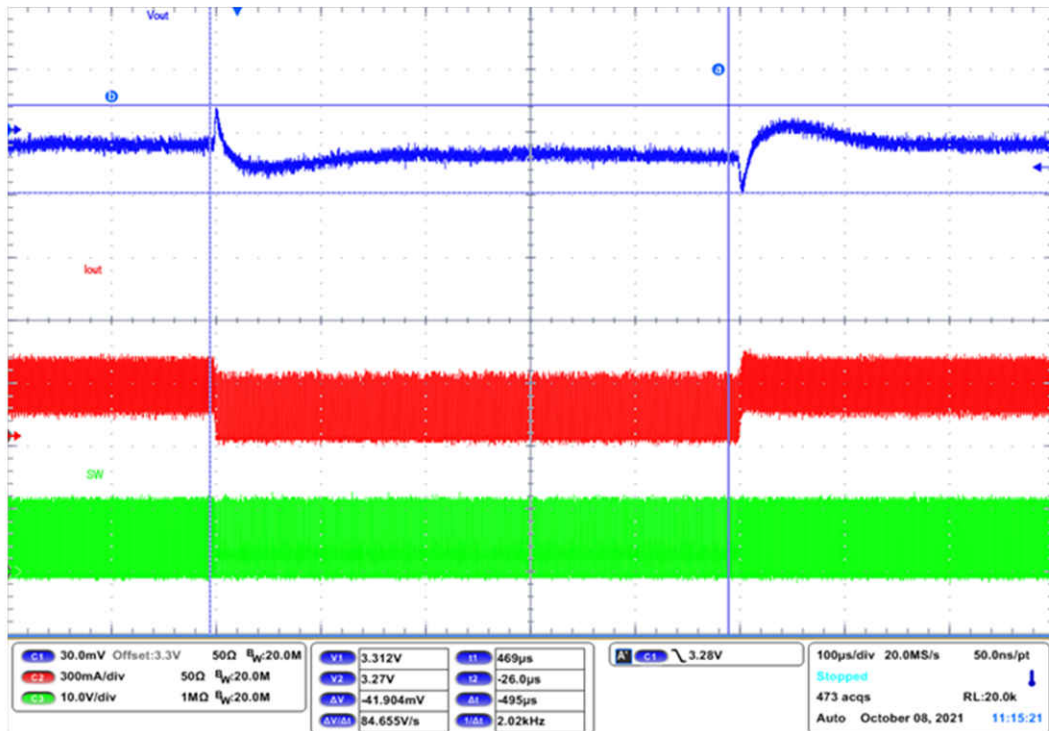

Figure 5-11. Load Transient Forced PWM VSET, $V_{IN} = 12\text{ V}$, $V_{OUT} = 3.3\text{ V}$, $I_{OUT} = 100\text{ mA}$ – 300 mA , Slew Rate = $1\text{ A}/\mu\text{s}$

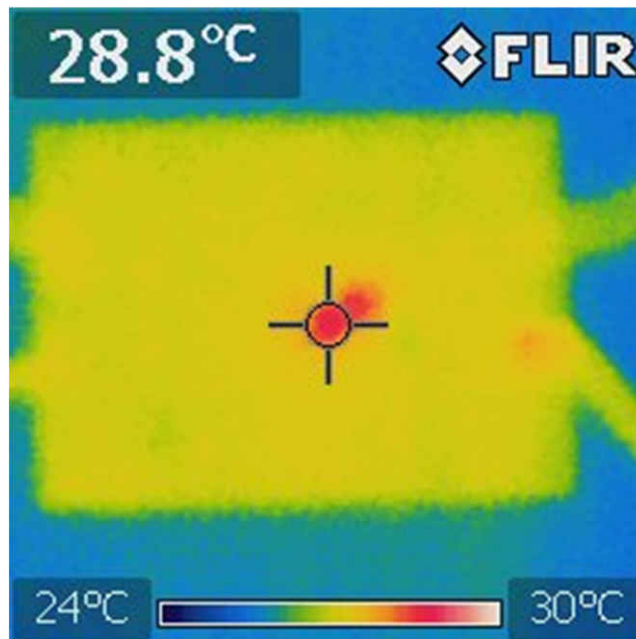

Figure 5-12. Thermal Performance Forced PWM, $V_{IN} = 12\text{ V}$, $V_{OUT} = 3.3\text{ V}$, $I_{OUT} = 300\text{ mA}$, $F_{SW} = 2.5\text{ MHz}$

6 Board Layout

This section provides the EVM board layout and illustrations.

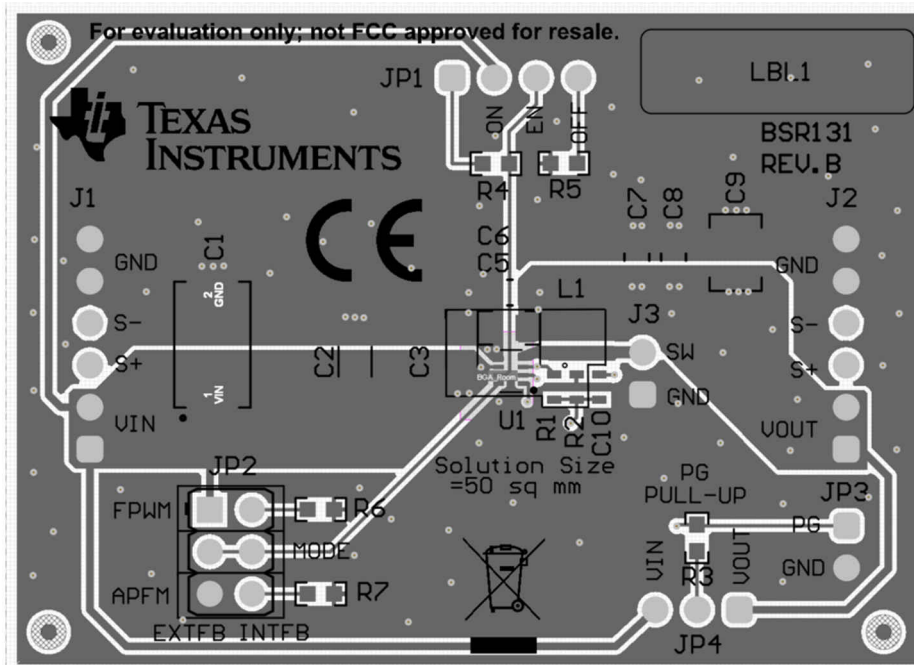

Figure 6-1. Top Assembly

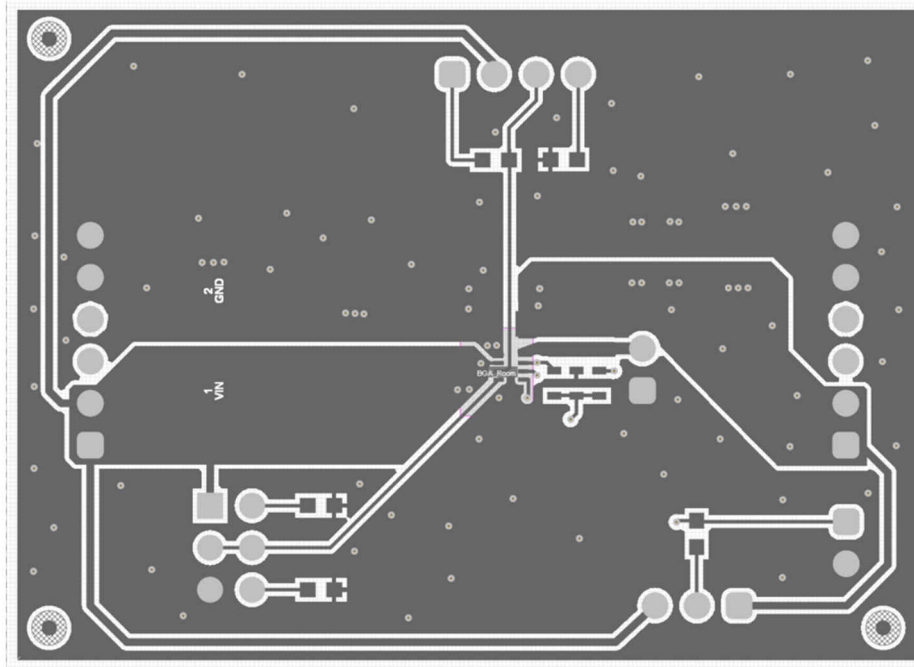

Figure 6-2. Top Layer

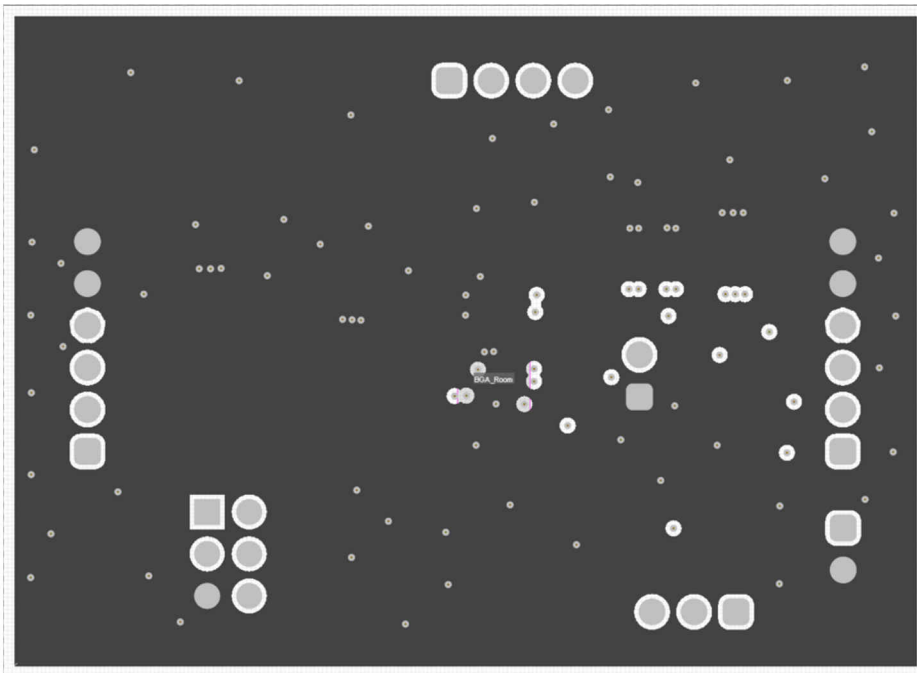

Figure 6-3. Internal Layer 1

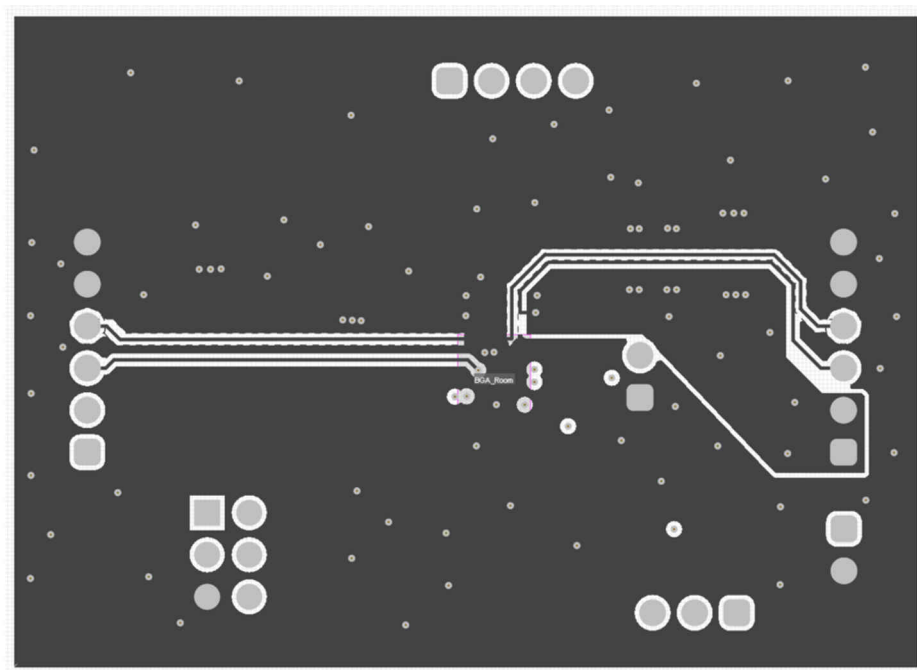

Figure 6-4. Internal Layer 2

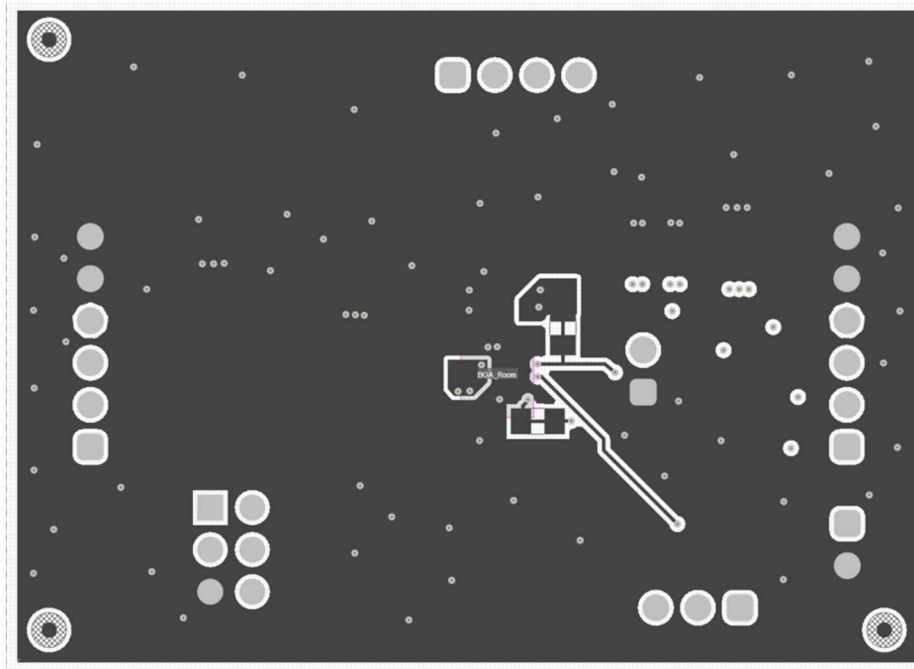

Figure 6-5. Bottom Layer

7 Schematic and Bill of Materials

This section provides the EVM schematic and bill of materials (BOM).

7.1 Schematic

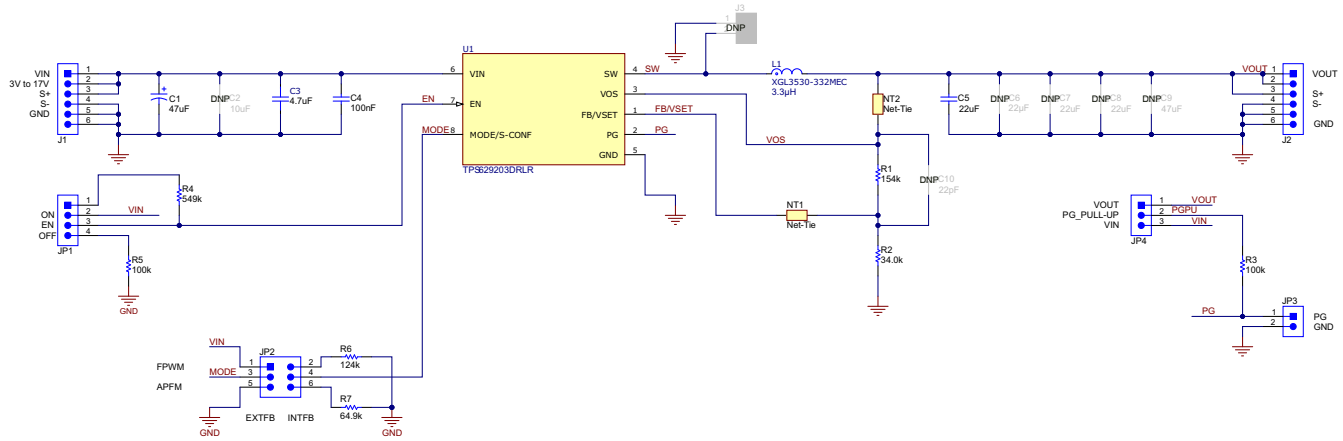

Figure 7-1. TPS629203EVM Schematic

7.2 Bill of Materials

Table 7-1. TPS629203EVM Bill of Materials

Designator	Qty	Value	Description	Package	Part Number	Manufacturer
C1	1	47 μ F	CAP, TA, 47 μ F, 35 V, \pm 10%, 0.3 Ω , SMD	7343-43	T495X476K035ATE300	Kemet
C3	1	4.7 μ F	Cap Ceramic 4.7- μ F 25-V X7R 10% Pad SMD 1206 +125°C Automotive T/R	1206	CGA5L1X7R1E475K160A C	TDK
C4	1	0.1 μ F	CAP, CERM, 0.1 μ F, 25 V, \pm 10%, X7R, 0603	0603	C0603C104K3RACTU	Kemet
C5	1	22 μ F	CAP, CERM, 22 μ F, 6.3 V, \pm 20%, X7T, AEC-Q200 Grade 1, 0805	0805	GCM21BD70J226ME36L	MuRata
J1, J2	2		Header, 2.54 mm, 6 \times 1, Gold, TH	Header, 2.54 mm, 6 \times 1, TH	61300611121	Würth Elektronik
JP1	1		Header, 2.54 mm, 4 \times 1, Gold, TH	Header, 2.54 mm, 4 \times 1, TH	61300411121	Würth Elektronik
JP2	1		Header, 2.54 mm, 3 \times 2, Gold, TH	Header, 2.54 mm, 3 \times 2, TH	61300621121	Würth Elektronik
JP3	1		Header, 2.54 mm, 2 \times 1, Gold, TH	Header, 2.54 mm, 2 \times 1, TH	61300211121	Würth Elektronik
JP4	1		Header, 2.54 mm, 3 \times 1, Gold, TH	Header, 2.54 mm, 2 \times 1, TH	61300311121	Würth Elektronik
L1	1	3.3 μ H	Molded Power Inductor, Shielded, 3.3 μ H 20%, 5.4 A, 37.4 m Ω DCR Max, AEC-Q200, T/R	SMT_IND_3M M2_3MM5	XGL3530-332MEC	Coilcraft
LBL1	1		Thermal Transfer Printable Labels, 0.650" W \times 0.200" H - 10,000 per roll	PCB Label	THT-14-423-10	Brady
R1	1	154 k	RES, 154 k, 1%, 0.1 W, 0603	0603	RC0603FR-07154KL	Yageo
R2	1	34.0 k	RES, 34.0 k, 1%, 0.1 W, 0603	0603	RC0603FR-0734KL	Yageo
R3, R5	2	100 k	RES, 100 k, 1%, 0.1 W, 0603	0603	RC0603FR-07100KL	Yageo
R4	1	549 k	RES, 549 k, 1%, 0.1 W, 0603	0603	RC0603FR-07549KL	Yageo
R6	1	124 k	RES, 124 k, 1%, 0.1 W, 0603	0603	RC0603FR-07124KL	Yageo
R7	1	64.9 k	RES, 64.9 k, 1%, 0.1 W, 0603	0603	RC0603FR-0764K9L	Yageo

Table 7-1. TPS629203EVM Bill of Materials (continued)

Designator	Qty	Value	Description	Package	Part Number	Manufacturer
U1	1		3-V to 17-V, Synchronous Buck Converters in 1.6-mm × 2.1-mm SOT583 Package	SOT583	TPS629203DRLR	Texas Instruments
C2	0	10 μ F	CAP, CERM, 10 μ F, 25 V, \pm 20%, X7R, 1206_190	1206_190	C3216X7R1E106M160AE	TDK
C6	0	22 μ F	CAP, CERM, 22 μ F, 6.3 V, \pm 20%, X7T, AEC-Q200 Grade 1, 0805	0805	CGA4J1X7T0J226M	TDK
C7, C8	0	22 μ F	CAP, CERM, 22 μ F, 10 V, \pm 20%, X7S, 0805	0805	C2012X7S1A226M125AC	TDK
C9	0	47 μ F	CAP, CERM, 47 μ F, 6.3 V, \pm 20%, X7R, 1210	1210	GRM32ER70J476ME20L	MuRata
C10	0	22 pF	CAP, CERM, 22 pF, 50 V, \pm 5%, C0G/NP0, 0603	0603	GRM1885C1H220JA01D	MuRata
J3	0		Header, 2.54 mm, 2 × 1, Gold, TH	Header, 2.54 mm, 2 × 1, TH	61300211121	Würth Elektronik

8 References

Texas Instruments, [TPS629203, 3 V to 17 V, 300-mA Low Iq Buck Converter in SOT583 Package](#) data sheet

IMPORTANT NOTICE AND DISCLAIMER

TI PROVIDES TECHNICAL AND RELIABILITY DATA (INCLUDING DATA SHEETS), DESIGN RESOURCES (INCLUDING REFERENCE DESIGNS), APPLICATION OR OTHER DESIGN ADVICE, WEB TOOLS, SAFETY INFORMATION, AND OTHER RESOURCES "AS IS" AND WITH ALL FAULTS, AND DISCLAIMS ALL WARRANTIES, EXPRESS AND IMPLIED, INCLUDING WITHOUT LIMITATION ANY IMPLIED WARRANTIES OF MERCHANTABILITY, FITNESS FOR A PARTICULAR PURPOSE OR NON-INFRINGEMENT OF THIRD PARTY INTELLECTUAL PROPERTY RIGHTS.

These resources are intended for skilled developers designing with TI products. You are solely responsible for (1) selecting the appropriate TI products for your application, (2) designing, validating and testing your application, and (3) ensuring your application meets applicable standards, and any other safety, security, regulatory or other requirements.

These resources are subject to change without notice. TI grants you permission to use these resources only for development of an application that uses the TI products described in the resource. Other reproduction and display of these resources is prohibited. No license is granted to any other TI intellectual property right or to any third party intellectual property right. TI disclaims responsibility for, and you will fully indemnify TI and its representatives against, any claims, damages, costs, losses, and liabilities arising out of your use of these resources.

TI's products are provided subject to [TI's Terms of Sale](#) or other applicable terms available either on ti.com or provided in conjunction with such TI products. TI's provision of these resources does not expand or otherwise alter TI's applicable warranties or warranty disclaimers for TI products.

TI objects to and rejects any additional or different terms you may have proposed.

Mailing Address: Texas Instruments, Post Office Box 655303, Dallas, Texas 75265
Copyright © 2022, Texas Instruments Incorporated