

TPS65311-Q1/TPS65310A-Q1 GPFET Soft Start Using a Capacitor Between GPFET Pin and PMOS-Protection Switch Source Pin

Krishnamurthy Hegde

MSA-ASP

ABSTRACT

TPS65311-Q1 and TPS65310A-Q1 devices are High-Voltage Power-Management Integrated Circuits (ICs) for use in Automotive Applications such as Advanced Driver Assistance Systems (ADAS). These devices provide the gate drive signal for the external PMOS-protection switch, which connects input voltage to the BUCK1 external-switching MOSFET. With the help of a small capacitor connected from the source of the external PMOS-protection switch to the gate drive pin (GPFET pin), it is possible to adjust the turnon time of this external PMOS-protection switch to reduce the inrush current when PMOS-protection switch turns on.

This application report provides guidelines for choosing the optimum soft-start capacitor between the GPFET pin and external PMOS-protection switch source pin to reduce the inrush current during turn on. This method was verified on the TPS65311-Q1 device. However, this part of the circuit is identical between TPS65310A-Q1 and TPS65311-Q1 devices and the results are applicable to the TPS65310A-Q1 device also.

Trademarks

All trademarks are the property of their respective owners.

1 Introduction

The TPS65311-Q1/TPS65310A-Q1 devices have an external PMOS gate drive output (GPFET), which turns on and off the main input supply (VINPROT) and BUCK1 input supply with the help of an external PMOS switch based on certain device operating conditions. The [TPS65311-Q1](#) datasheet provides further details related to GPFET pin operating conditions.

Internal to the device, a PMOS transistor connected from VIN pin to GPFET pin pulls the GPFET pin high (to Vin voltage level) to keep the external PMOS switch in off condition. During the turn on process of the external PMOS switch, the internal PMOS switch connected from Vin to GPFET is turned off and GPFET pin is pulled low with the help of 20- μ A (typical) pulldown current source. Detailed specifications of the GPFET pin is provided in [Table 1](#).

As shown in [Figure 1](#), with the help of an external soft-start capacitor (C_{ss_gpfet}) connected between source pin of external PMOS-protection switch and GPFET pin, it is possible to adjust the turn on characteristics of the external PMOS-protection switch connected to the GPFET pin.

Table 1. GPFET Pin Specifications From TPS65311-Q1 Datasheet (SLVSCA6 Rev B)

PARAMETER		TEST CONDITIONS	MIN	TYP	MAX	UNIT
EXTERNAL PROTECTION						
VCLAMP	Gate to source clamp voltage	VIN – GPFET, 100 μ A	14		20	V
IGPFET	Gate turn on current	VIN = 14 V, GPFET = 2 V	15		25	μ A
RDSONGFET	Gate driver strength	VIN = 14 V, turn off			25	Ω

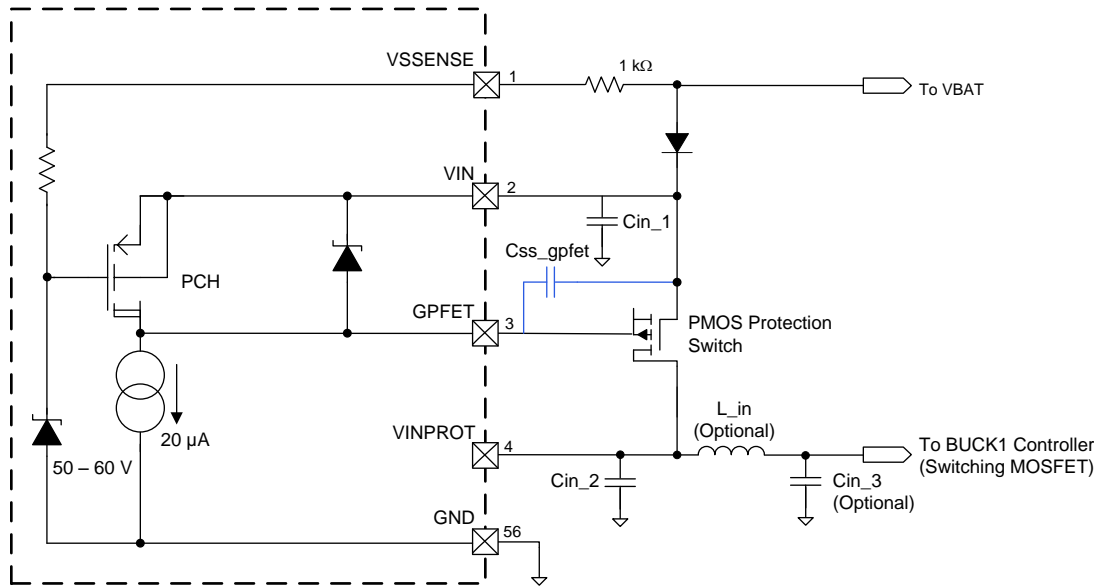

Figure 1. GPFET PMOS Switch Drive Control Circuitry With C_{ss_gpfet}

2 Test Setup and Procedure

A TPS65311EVM was used to check the effect of C_{ss_gpfet} with the following test conditions:

- Vbat (Input supply) = 12 V (Bench-top power supply with 4-A current rating)
- BUCK1 Output Voltage, VBUCK1 = 3.3 V
- External PMOS switch: SI7461DP
- Lout_BUCK1 = 10 μ H
- Cout_BUCK1 = 100 μ F (total capacitance)
- Input LC filter inductor value (L_{in}) = 10 μ H
- Input capacitor values are as follows:
 - Cin_1 = 22 μ F
 - Cin_2 = 47 μ F
 - Cin_3 = 47 μ F

Functionality is tested at room temperature with no external load conditions.

3 Test Procedure and Measurement Results

To understand the effect of the C_{ss_gpfet} capacitor on overall system behavior, different measurements were done as below.

- TPS65311-Q1 start-up behavior with Vbat ramped from 0 V to 12 V is captured without an external C_{ss_gpfet} capacitor as a reference as shown in [Figure 2](#).
- The measurement is repeated with the following different C_{ss_gpfet} values: 1 nF, 2.2 nF, 4.7 nF, 10 nF, 15 nF, 100 nF, and 470 nF.
- For each case, different timing measurements are taken and listed in [Table 2](#).
- Input inrush current during start up is measured and its rise time and peak current are tabulated in [Table 3](#). Timing diagram for this measurement is shown in [Figure 3](#).
- Shutdown behavior is also measured to see the effect of C_{ss_gpfet} on device shutdown.

3.1 Device Start Up Behavior Measurement Results

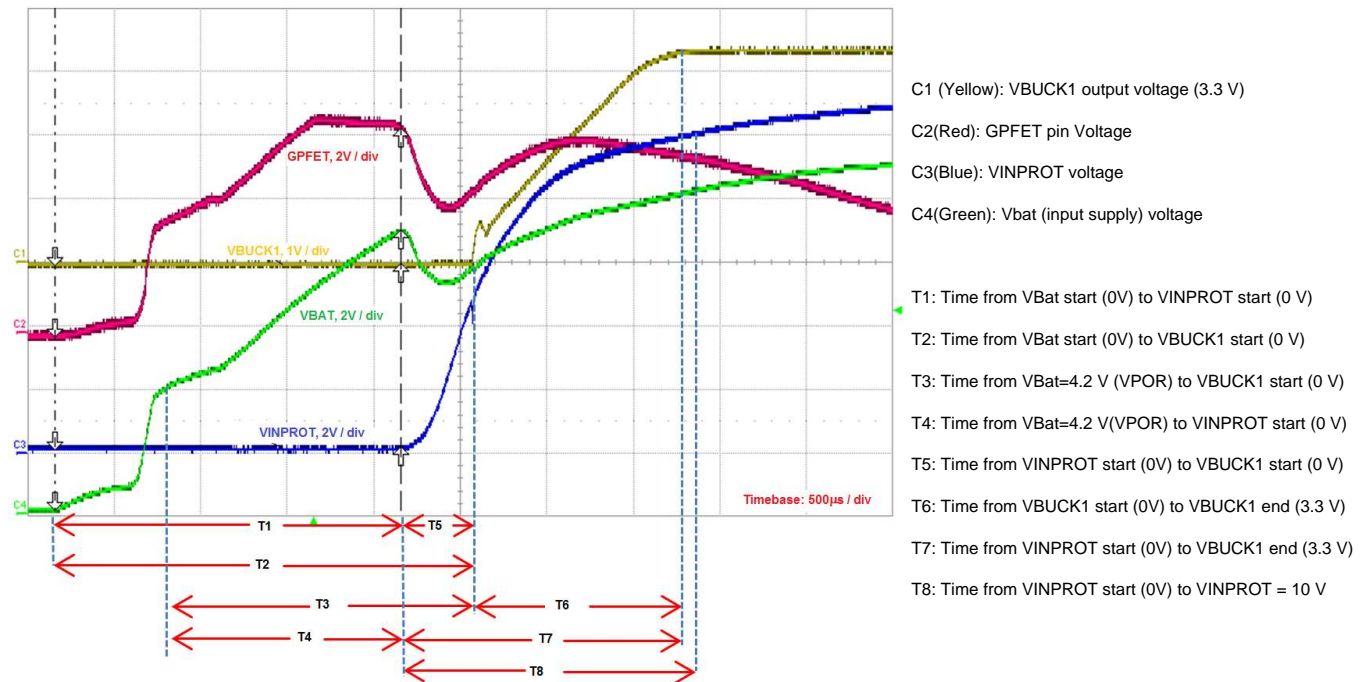

Figure 2. Start-up Timing Diagram

Table 2. Timing Measurement Results With Different Soft-Start Capacitors Across GPFET Pin and External PMOS Switch Source Pin

Css_gpfet	T1 (ms)	T2 (ms)	T3(ms)	T4 (ms)	T5 (µS)	T6 (ms)	T7 (ms)	T8 (ms)
No Css_gpfet	2.001	2.404	1.741	1.339	404.32	1.214	1.603	1.665
1nF	2.105	2.513	1.867	1.460	431.32	1.219	1.630	1.691
2.2nF	2.234	2.649	1.995	1.578	447.56	1.215	1.645	1.645
4.7nF	2.473	2.964	2.300	1.827	483.43	1.212	1.694	1.527
10nF	2.994	3.544	2.892	2.342	537.95	1.201	1.743	1.293
15nF	3.467	4.204	3.555	2.819	737.33	1.214	1.945	1.373
100nF	11.577	13.673	12.974	10.646	2276.06	1.216	3.363	3.115

3.2 Input Inrush Current Measurement Results

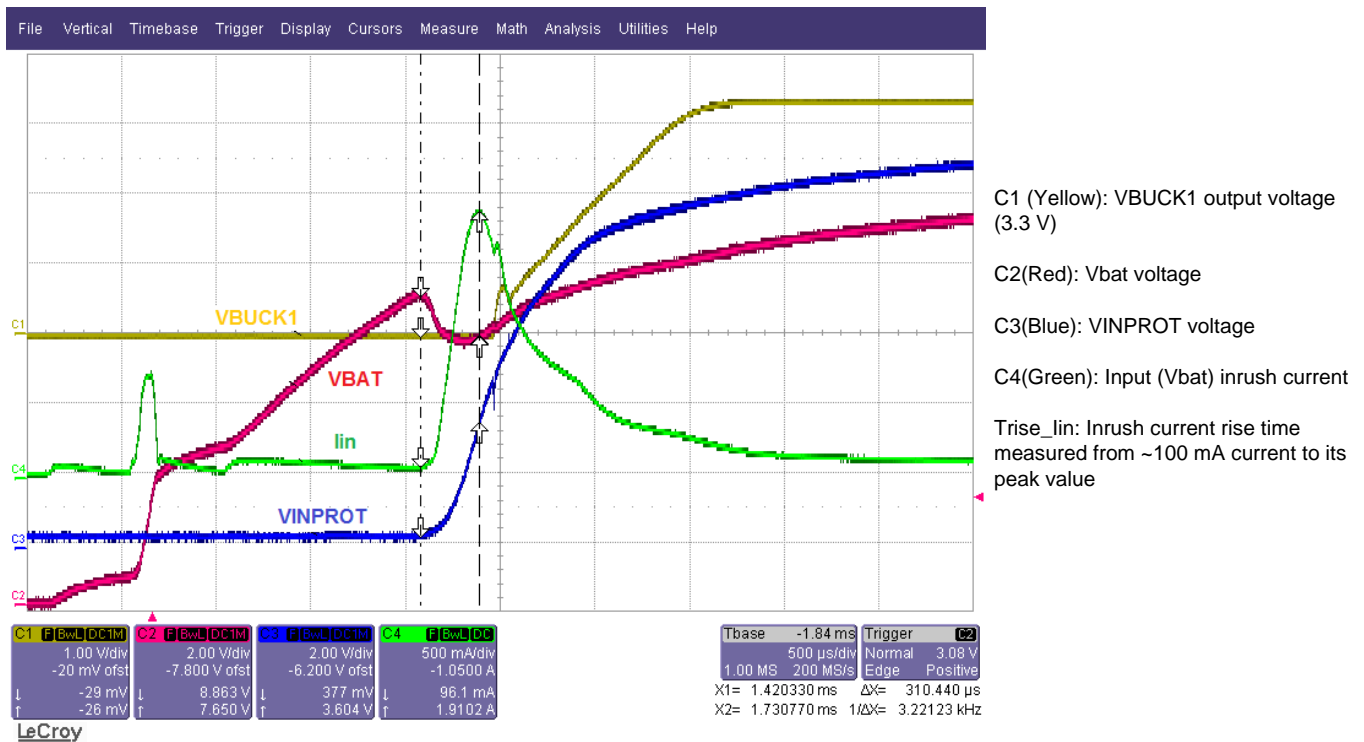

Figure 3. Start-up Timing Diagram With Input Inrush Current

Table 3. Input Inrush Current Measurement Results With Different C_{ss_gpfet} Capacitors

C_{ss_gpfet}	Trise_lin (μ s)	Peak Inrush Current (A)
No C_{ss_gpfet}	310	1.9
1 nF	337	1.8
2.2 nF	382	1.8
4.7 nF	408	1.8
10 nF	553	1.7
15 nF	614	1.6
100 nF	1949	0.8

3.3 Device Shutdown Behavior Results

For each case (No C_{ss_gpfet} , C_{ss_gpfet} = 1 nF, 2.2 nF, 4.7 nF, 10 nF, 15 nF, and 100 nF), device shutdown behavior is checked to see whether C_{ss_gpfet} influences the shutdown behavior. Based on the measurement results, it is clear that this capacitor does not have much influence on the shutdown behavior. This is also expected per design due to the presence of a strong internal pullup transistor (with max R_{dson} resistance = 25 ohm) between GPFET pin and VIN pin. Figure 4 and Figure 5 show the shutdown behavior without C_{ss_gpfet} and with C_{ss_gpfet} = 100 nF, respectively.

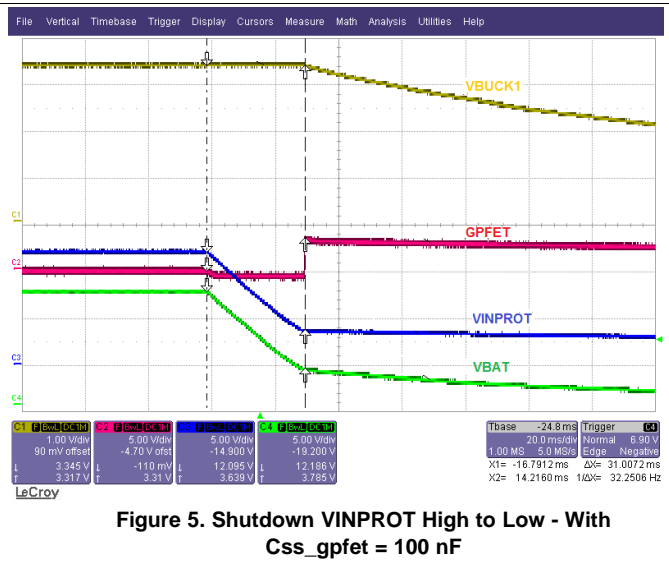
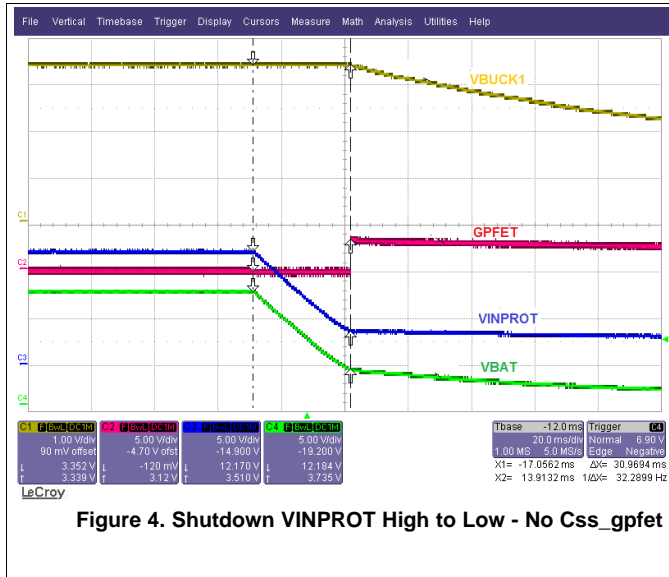

3.4 Device Start Up Behavior With Large C_{ss_gpfet} Capacitor

Since the external PMOS-protection switch is turned off with the help of a weak pulldown current source (20 μ A, typical, internal to the GPFET pin), a very large C_{ss_gpfet} may prevent the PMOS-protection switch from turning on. To check this behavior, C_{ss_gpfet} value was increased to 470 nF. With this capacitor value, the external PMOS-protection switch does not turn on correctly as shown in Figure 7.

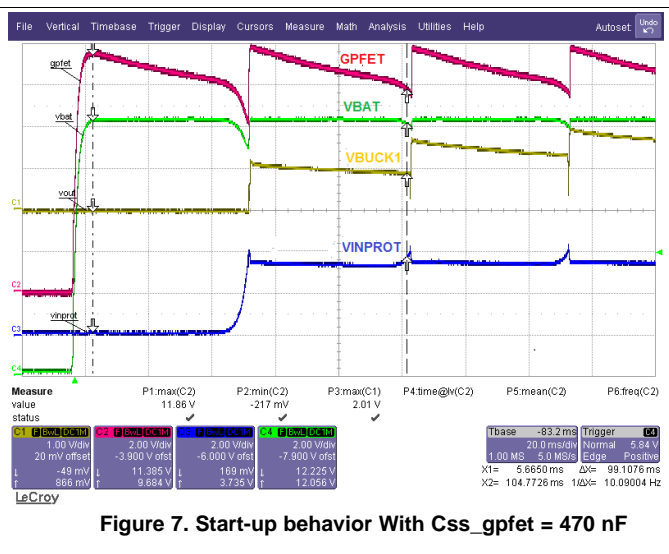
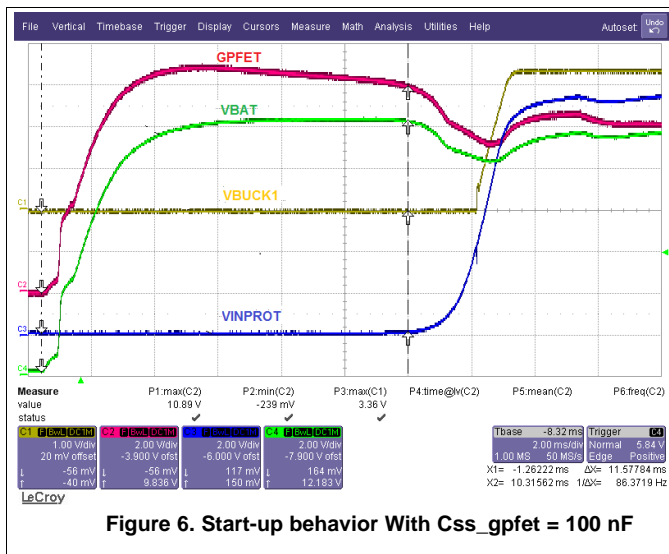

4 Observations and Conclusions

Measurement results show that with the help of C_{ss_gpfet} capacitor, it is possible to control the turnon characteristics of external P-MOS protection switch to reduce the inrush current during its turn on. An optimum C_{ss_gpfet} capacitor value depends mainly on external application conditions, hence the exact value of this capacitor cannot be provided. Select this capacitor value based on measurements done on the actual application. Use this application note only as a reference document for optimizing the C_{ss_gpfet} capacitor.

Based on the measurements done with the application condition mentioned in the [Section 3](#) section, the following observations and conclusions are made:

- With a C_{ss_gpfet} capacitor (less than 100 nF) between GPFET pin and source of external PMOS transistor, it is possible to adjust the timing between start of BUCK1 output or start of VINPROT voltage with respect to V_{bat} .
- With the help of C_{ss_gpfet} capacitor, input inrush current magnitude and its slew rate can be reduced.
- Rise time of BUCK1 output is not affected by C_{ss_gpfet} .
- Rise time of VINPROT, with reference to the time at which VBUCK1 reaches 3.3 V, is slowed down with increasing C_{ss_gpfet} .
- Higher value capacitors, like 470 nF for C_{ss_gpfet} , will not allow GPFET to turn on since the 20 μ A pulldown current source is too weak to pull the GPFET pin sufficiently low.
- Shutdown behavior does not change much with different C_{ss_gpfet} values.
- Since the effect of C_{ss_gpfet} mainly depends on actual components (Example: Cout, Lout, LC filter, PMOS-protection switch, and so forth) used on the board, it is recommended to finalize this capacitor value based on actual measurements done on the customer board. Keep this capacitor as small as possible.
- Also, results may vary depending on the input power supply used. The recommendation is to use a real car battery for more accurate measurements.
- All timing specifications related to device power-up sequencing in the datasheet are specified without considering the C_{ss_gpfet} capacitor and some of the power-up timing parameters may change with the addition of C_{ss_gpfet} capacitor. For example, t_{START} timing ([TPS65311-Q1](#) datasheet, [Figure 24. Power-up Sequencing](#)) may be changed with addition of C_{ss_gpfet} capacitor.

Revision History

DATE	REVISION	NOTES
November 2016	*	Initial Release

IMPORTANT NOTICE

Texas Instruments Incorporated and its subsidiaries (TI) reserve the right to make corrections, enhancements, improvements and other changes to its semiconductor products and services per JESD46, latest issue, and to discontinue any product or service per JESD48, latest issue. Buyers should obtain the latest relevant information before placing orders and should verify that such information is current and complete. All semiconductor products (also referred to herein as "components") are sold subject to TI's terms and conditions of sale supplied at the time of order acknowledgment.

TI warrants performance of its components to the specifications applicable at the time of sale, in accordance with the warranty in TI's terms and conditions of sale of semiconductor products. Testing and other quality control techniques are used to the extent TI deems necessary to support this warranty. Except where mandated by applicable law, testing of all parameters of each component is not necessarily performed.

TI assumes no liability for applications assistance or the design of Buyers' products. Buyers are responsible for their products and applications using TI components. To minimize the risks associated with Buyers' products and applications, Buyers should provide adequate design and operating safeguards.

TI does not warrant or represent that any license, either express or implied, is granted under any patent right, copyright, mask work right, or other intellectual property right relating to any combination, machine, or process in which TI components or services are used. Information published by TI regarding third-party products or services does not constitute a license to use such products or services or a warranty or endorsement thereof. Use of such information may require a license from a third party under the patents or other intellectual property of the third party, or a license from TI under the patents or other intellectual property of TI.

Reproduction of significant portions of TI information in TI data books or data sheets is permissible only if reproduction is without alteration and is accompanied by all associated warranties, conditions, limitations, and notices. TI is not responsible or liable for such altered documentation. Information of third parties may be subject to additional restrictions.

Resale of TI components or services with statements different from or beyond the parameters stated by TI for that component or service voids all express and any implied warranties for the associated TI component or service and is an unfair and deceptive business practice. TI is not responsible or liable for any such statements.

Buyer acknowledges and agrees that it is solely responsible for compliance with all legal, regulatory and safety-related requirements concerning its products, and any use of TI components in its applications, notwithstanding any applications-related information or support that may be provided by TI. Buyer represents and agrees that it has all the necessary expertise to create and implement safeguards which anticipate dangerous consequences of failures, monitor failures and their consequences, lessen the likelihood of failures that might cause harm and take appropriate remedial actions. Buyer will fully indemnify TI and its representatives against any damages arising out of the use of any TI components in safety-critical applications.

In some cases, TI components may be promoted specifically to facilitate safety-related applications. With such components, TI's goal is to help enable customers to design and create their own end-product solutions that meet applicable functional safety standards and requirements. Nonetheless, such components are subject to these terms.

No TI components are authorized for use in FDA Class III (or similar life-critical medical equipment) unless authorized officers of the parties have executed a special agreement specifically governing such use.

Only those TI components which TI has specifically designated as military grade or "enhanced plastic" are designed and intended for use in military/aerospace applications or environments. Buyer acknowledges and agrees that any military or aerospace use of TI components which have **not** been so designated is solely at the Buyer's risk, and that Buyer is solely responsible for compliance with all legal and regulatory requirements in connection with such use.

TI has specifically designated certain components as meeting ISO/TS16949 requirements, mainly for automotive use. In any case of use of non-designated products, TI will not be responsible for any failure to meet ISO/TS16949.

Products

Audio	www.ti.com/audio
Amplifiers	amplifier.ti.com
Data Converters	dataconverter.ti.com
DLP® Products	www.dlp.com
DSP	dsp.ti.com
Clocks and Timers	www.ti.com/clocks
Interface	interface.ti.com
Logic	logic.ti.com
Power Mgmt	power.ti.com
Microcontrollers	microcontroller.ti.com
RFID	www.ti-rfid.com
OMAP Applications Processors	www.ti.com/omap
Wireless Connectivity	www.ti.com/wirelessconnectivity

Applications

Automotive and Transportation	www.ti.com/automotive
Communications and Telecom	www.ti.com/communications
Computers and Peripherals	www.ti.com/computers
Consumer Electronics	www.ti.com/consumer-apps
Energy and Lighting	www.ti.com/energy
Industrial	www.ti.com/industrial
Medical	www.ti.com/medical
Security	www.ti.com/security
Space, Avionics and Defense	www.ti.com/space-avionics-defense
Video and Imaging	www.ti.com/video

TI E2E Community

e2e.ti.com