

## 150mA, Low-Dropout Regulator, Ultralow-Power, $I_Q$ 1 $\mu$ A with Pin-Selectable, Dual-Level Output Voltage

### FEATURES

- Low  $I_Q$ : 1 $\mu$ A
- 150mA, Low-Dropout Regulator with Pin-Selectable Dual Voltage Level Output
- Low Dropout: 200mV at 150mA
- 3% Accuracy Over Load/Line/Temperature
- Available in Dual-Level, Fixed Output Voltages from 1.5V to 4.2V Using Innovative Factory EPROM Programming
- Available in an Adjustable Version from 1.22V to 5.25V or a Dual-Level Output Version
- $V_{SET}$  Pin Toggles Output Voltage Between Two Factory-Programmed Voltage Levels
- Stable with a 1.0 $\mu$ F Ceramic Capacitor
- Thermal Shutdown and Overcurrent Protection
- CMOS Logic Level-Compatible Enable Pin
- Available in DDC (TSOT23-5) or DRV (2mm  $\times$  2mm SON-6) Package Options

### APPLICATIONS

- TI **MSP430** Attach Applications
- Power Rails with Programming Mode
- Dual Voltage Levels for Power-Saving Mode
- Wireless Handsets, Smartphones, PDAs, MP3 Players, and Other Battery-Operated Handheld Products

### DESCRIPTION

The TPS781 family of low-dropout (LDO) regulators offer the benefits of ultralow power ( $I_Q = 1\mu\text{A}$ ), miniaturized packaging (2 $\times$ 2 SON-6), and selectable dual-level output voltage levels. An adjustable version is also available, but does not have the capability to shift voltage levels.

The  $V_{SET}$  pin allows the end user to switch between two voltage levels *on-the-fly* through a microprocessor-compatible input. This LDO is designed specifically for battery-powered applications where dual-level voltages are needed. With ultralow  $I_Q$  (1 $\mu\text{A}$ ), microprocessors, memory cards, and smoke detectors are ideal applications for this device.

The ultralow-power and selectable dual-level output voltages allow designers to customize power consumption for specific applications. Designers can now shift to a lower voltage level in a battery-powered design when the microprocessor is in sleep mode, further reducing overall system power consumption. The two voltage levels are preset at the factory through a unique architecture using an EPROM. The EPROM technique allows for numerous output voltage options between  $V_{SET}$  low (1.5V to 4.2V) and  $V_{SET}$  high (2.0V to 3.0V) in the fixed output version only. Consult with your local factory representative for exact voltage options and ordering information; minimum order quantities may apply.

The TPS781 series are designed to be compatible with the TI MSP430 and other similar products. The enable pin is compatible with standard CMOS logic. This LDO is stable with any output capacitor greater than 1.0 $\mu\text{F}$ . Therefore, implementations of this device require minimal board space because of miniaturized packaging and a potentially small output capacitor. The TPS781 series  $I_Q$  (1 $\mu\text{A}$ ) also come with thermal shutdown and current limit to protect the device during fault conditions. All packages have an operating temperature range of  $T_J = -40^\circ\text{C}$  to  $+125^\circ\text{C}$ . For high-performance applications requiring a dual-level voltage option, consider the [TPS780 series](#), with an  $I_Q$  of 500nA and dynamic voltage scaling.

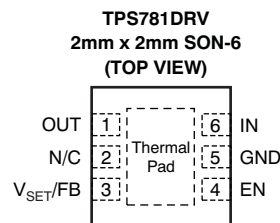
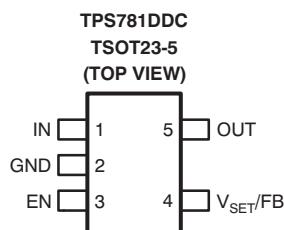

Please be aware that an important notice concerning availability, standard warranty, and use in critical applications of Texas Instruments semiconductor products and disclaimers thereto appears at the end of this data sheet.

All trademarks are the property of their respective owners.



This integrated circuit can be damaged by ESD. Texas Instruments recommends that all integrated circuits be handled with appropriate precautions. Failure to observe proper handling and installation procedures can cause damage.

ESD damage can range from subtle performance degradation to complete device failure. Precision integrated circuits may be more susceptible to damage because very small parametric changes could cause the device not to meet its published specifications.

**ORDERING INFORMATION<sup>(1)(2)</sup>**

PRODUCT	V <sub>OUT</sub>
TPS781vvvxxxyyyz	VVV is the nominal output voltage for V <sub>OUT(HIGH)</sub> and corresponds to V <sub>SET</sub> pin low. XXX is the nominal output voltage for V <sub>OUT(LOW)</sub> and corresponds to V <sub>SET</sub> pin high. YYY is the package designator. Z is the tape and reel quantity (R = 3000, T = 250). Adjustable version <sup>(3)(4)</sup>

- (1) For the most current package and ordering information see the Package Option Addendum at the end of this document, or see the TI web site at [www.ti.com](http://www.ti.com).
- (2) Additional output voltage combinations are available on a quick-turn basis using innovative, factory EPROM programming. Minimum-order quantities apply; contact your sales representative for details and availability.
- (3) To order the adjustable version, use TPS78101YYYY.
- (4) The device is either fixed voltage, dual-level V<sub>OUT</sub>, or adjustable voltage only. Device design does not permit a fixed and adjustable output simultaneously.

**ABSOLUTE MAXIMUM RATINGS<sup>(1)</sup>**

At T<sub>J</sub> = -40°C to +125°C, unless otherwise noted. All voltages are with respect to GND.

PARAMETER	TPS781 Series	UNIT
Input voltage range, V <sub>IN</sub>	-0.3 to +6.0	V
Enable and V <sub>SET</sub> voltage range, V <sub>EN</sub> and V <sub>VSET</sub>	-0.3 to V <sub>IN</sub> + 0.3 <sup>(2)</sup>	V
Output voltage range, V <sub>OUT</sub>	-0.3 to V <sub>IN</sub> + 0.3V	V
Maximum output current, I <sub>OUT</sub>	Internally limited	
Output short-circuit duration	Indefinite	
Total continuous power dissipation, P <sub>DISS</sub>	See the <a href="#">Dissipation Ratings</a> table	
ESD rating	Human body model (HBM)	2 kV
	Charged device model (CDM)	500 V
Operating junction temperature range, T <sub>J</sub>	-40 to +125	°C
Storage temperature range, T <sub>STG</sub>	-55 to +150	°C

- (1) Stresses above these ratings may cause permanent damage. Exposure to absolute maximum conditions for extended periods may degrade device reliability. These are stress ratings only, and functional operation of the device at these or any other conditions beyond those specified is not implied.
- (2) V<sub>EN</sub> and V<sub>VSET</sub> absolute maximum rating are V<sub>IN</sub> + 0.3V or +6.0V, whichever is less.

**DISSIPATION RATINGS**

BOARD	PACKAGE	R <sub>θJC</sub>	R <sub>θJA</sub>	DERATING FACTOR ABOVE T <sub>A</sub> = +25°C	T <sub>A</sub> < +25°C	T <sub>A</sub> = +70°C	T <sub>A</sub> = +85°C
High-K <sup>(1)</sup>	DRV	20°C/W	65°C/W	15.4mW/°C	1540mW	845mW	615mW
High-K <sup>(1)</sup>	DDC	90°C/W	200°C/W	5.0mW/°C	500mW	275mW	200mW

- (1) The JEDEC high-K (2s2p) board used to derive this data was a 3-inch × 3-inch, multilayer board with 1-ounce internal power and ground planes and 2-ounce copper traces on top and bottom of the board.

**ELECTRICAL CHARACTERISTICS**

Over operating temperature range ( $T_J = -40^{\circ}\text{C}$  to  $+125^{\circ}\text{C}$ ),  $V_{IN} = V_{OUT(NOM)} + 0.5\text{V}$  or  $2.2\text{V}$ , whichever is greater;  $I_{OUT} = 100\mu\text{A}$ ,  $V_{VSET} = V_{EN} = V_{IN}$ ,  $C_{OUT} = 1.0\mu\text{F}$ , fixed or adjustable, unless otherwise noted. Typical values at  $T_J = +25^{\circ}\text{C}$ .

PARAMETER		TEST CONDITIONS		TPS781 Series			UNIT
				MIN	TYP	MAX	
$V_{IN}$	Input voltage range			2.2		5.5	V
$V_{OUT}^{(1)}$	DC output accuracy	Nominal	$T_J = +25^{\circ}\text{C}$ , $V_{SET} = \text{high/low}$	-2	$\pm 1$	+2	%
		Over $V_{IN}$ , $I_{OUT}$ , temperature	$V_{OUT} + 0.5\text{V} \leq V_{IN} \leq 5.5\text{V}$ , $0\text{mA} \leq I_{OUT} \leq 150\text{mA}$ , $V_{SET} = \text{high/low}$	-3.0	$\pm 2.0$	+3.0	%
$V_{FB}$	Internal reference <sup>(2)</sup> (adjustable version only)		$T_J = +25^{\circ}\text{C}$ , $V_{IN} = 4.0\text{V}$ , $I_{OUT} = 75\text{mA}$		1.216		V
$V_{OUT\_RANGE}$	Output voltage range <sup>(3)(4)</sup> (adjustable version only)		$V_{IN} = 5.5\text{V}$ , $I_{OUT} = 100\mu\text{A}^{(2)}$	$V_{FB}$	5.25		V
$\Delta V_{OUT}/\Delta V_{IN}$	Line regulation		$V_{OUT(NOM)} + 0.5\text{V} \leq V_{IN} \leq 5.5\text{V}$ , $I_{OUT} = 5\text{mA}$	-1		+1	%
$\Delta V_{OUT}/\Delta I_{OUT}$	Load regulation		$0\text{mA} \leq I_{OUT} \leq 150\text{mA}$	-2		+2	%
$V_{DO}$	Dropout voltage <sup>(5)</sup>		$V_{IN} = 95\% V_{OUT(NOM)}$ , $I_{OUT} = 150\text{mA}$			250	mV
$V_N$	Output noise voltage		$BW = 100\text{Hz}$ to $100\text{kHz}$ , $V_{IN} = 2.2\text{V}$ , $V_{OUT} = 1.2\text{V}$ , $I_{OUT} = 1\text{mA}$		86		$\mu\text{V}_{RMS}$
$V_{HI}$	$V_{SET}$ high (output $V_{OUT(LOW)}$ selected), or EN high (enabled)			1.2		$V_{IN}$	V
$V_{LO}$	$V_{SET}$ low (output $V_{OUT(HIGH)}$ selected), or EN low (disabled)			0		0.4	V
$I_{CL}$	Output current limit		$V_{OUT} = 0.90 \times V_{OUT(NOM)}$	150	230	400	mA
$I_{GND}$	Ground pin current		$I_{OUT} = 0\text{mA}$		1.0	1.3	$\mu\text{A}$
			$I_{OUT} = 150\text{mA}$		8		$\mu\text{A}$
$I_{SHDN}$	Shutdown current ( $I_{GND}$ )		$V_{EN} \leq 0.4\text{V}$ , $2.2\text{V} \leq V_{IN} < 5.5\text{V}$ , $T_J = -40^{\circ}\text{C}$ to $+100^{\circ}\text{C}$		18	130	nA
$I_{VSET}$	$V_{SET}$ pin current		$V_{EN} = V_{VSET} = 5.5\text{V}$			70	nA
$I_{EN}$	EN pin current		$V_{EN} = V_{VSET} = 5.5\text{V}$			40	nA
$I_{FB}$	FB pin current <sup>(6)</sup> (adjustable version only)		$V_{IN} = 5.5\text{V}$ , $V_{OUT} = 1.2\text{V}$ , $I_{OUT} = 100\mu\text{A}$			10	nA
PSRR	Power-supply rejection ratio	$V_{IN} = 4.3\text{V}$ , $V_{OUT} = 3.3\text{V}$ , $I_{OUT} = 150\text{mA}$	$f = 10\text{Hz}$		40		dB
			$f = 100\text{Hz}$		20		dB
			$f = 1\text{kHz}$		15		dB
$t_{TR(H \rightarrow L)}$	$V_{OUT}$ transition time (high-to-low) $V_{OUT} = 97\% \times V_{OUT(HIGH)}$		$V_{OUT\_LOW} = 2.2\text{V}$ , $V_{OUT(HIGH)} = 3.3\text{V}$ , $I_{OUT} = 10\text{mA}$		800		$\mu\text{s}$
$t_{TR(L \rightarrow H)}$	$V_{OUT}$ transition time (low-to-high) $V_{OUT} = 97\% \times V_{OUT(LOW)}$		$V_{OUT\_HIGH} = 3.3\text{V}$ , $V_{OUT(LOW)} = 2.2\text{V}$ , $I_{OUT} = 10\text{mA}$		800		$\mu\text{s}$
$t_{STR}$	Startup time <sup>(7)</sup>		$C_{OUT} = 1.0\mu\text{F}$ , $V_{OUT} = 10\% V_{OUT(NOM)}$ to $V_{OUT} = 90\% V_{OUT(NOM)}$		500		$\mu\text{s}$
$t_{SHDN}$	Shutdown time <sup>(8)</sup>		$I_{OUT} = 150\text{mA}$ , $C_{OUT} = 1.0\mu\text{F}$ , $V_{OUT} = 2.8\text{V}$ , $V_{OUT} = 90\% V_{OUT(NOM)}$ to $V_{OUT} = 10\% V_{OUT(NOM)}$		500 <sup>(9)</sup>		$\mu\text{s}$
$T_{SD}$	Thermal shutdown temperature		Shutdown, temperature increasing		+160		$^{\circ}\text{C}$
			Reset, temperature decreasing		+140		$^{\circ}\text{C}$
$T_J$	Operating junction temperature			-40		+125	$^{\circ}\text{C}$

- (1) The output voltage for  $V_{SET} = \text{low/high}$  is programmed at the factory.
- (2) Adjustable version only.
- (3) No  $V_{SET}$  pin on the adjustable version.
- (4) No dynamic voltage scaling on the adjustable version.
- (5)  $V_{DO}$  is not measured for devices with  $V_{OUT(NOM)} < 2.3\text{V}$  because minimum  $V_{IN} = 2.2\text{V}$ .
- (6) The TPS78101 FB pin is tied to  $V_{OUT}$ . Adjustable version only.
- (7) Time from  $V_{EN} = 1.2\text{V}$  to  $V_{OUT} = 90\% (V_{OUT(NOM)})$ .
- (8) Time from  $V_{EN} = 0.4\text{V}$  to  $V_{OUT} = 10\% (V_{OUT(NOM)})$ .
- (9) See [Shutdown](#) in the [Application Information](#) section for more details.

### FUNCTIONAL BLOCK DIAGRAM

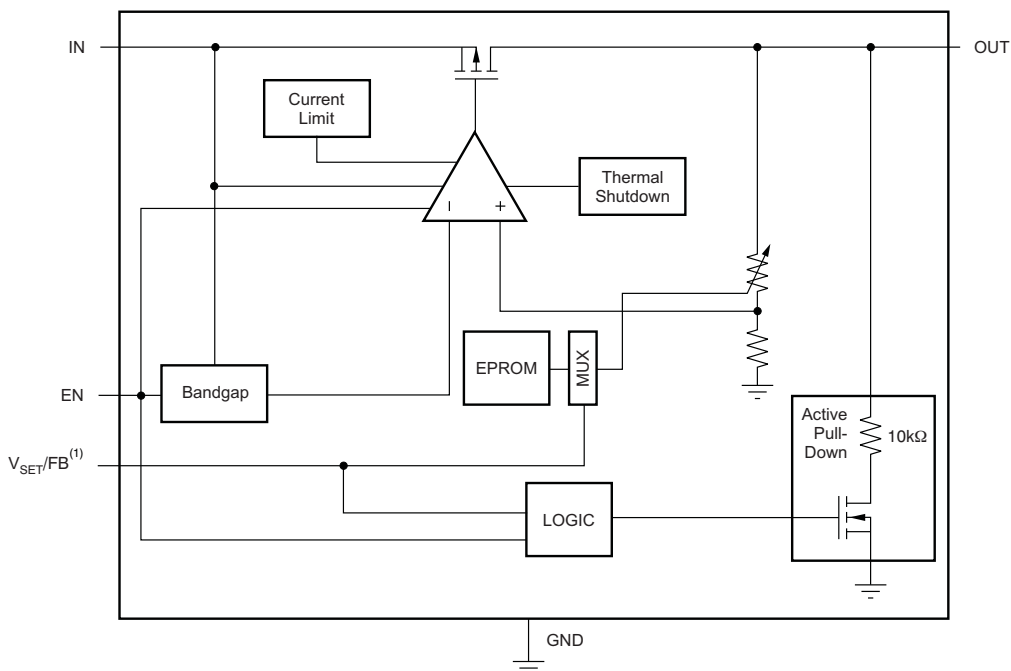

(1) Feedback pin (FB) for adjustable versions;  $V_{SET}$  for fixed voltage versions.

### PIN CONFIGURATIONS

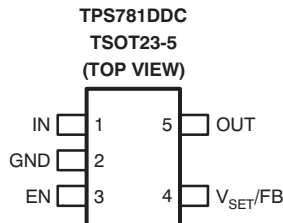
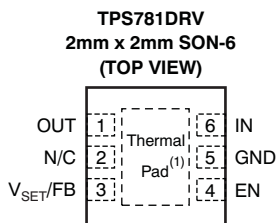

(1) It is recommended that the SON package thermal pad be connected to ground.

**Table 1. TERMINAL FUNCTIONS**

TERMINAL			DESCRIPTION
NAME	DRV	DDC	
OUT	1	5	Regulated output voltage pin. A small (1 $\mu$ F) ceramic capacitor is needed from this pin to ground to assure stability. See the <i>Input and Output Capacitor Requirements</i> in the Application Information section for more details.
N/C	2	—	Not connected.
$V_{SET}/FB$	3	4	Feedback pin (FB) for adjustable versions; $V_{SET}$ for fixed voltage versions. Driving the select pin ( $V_{SET}$ ) below 0.4V selects preset output voltage high. Driving the $V_{SET}$ pin over 1.2V selects preset output voltage low.
EN	4	3	Driving the enable pin (EN) over 1.2V turns on the regulator. Driving this pin below 0.4V puts the regulator into shutdown mode, reducing operating current to 18nA typical.
GND	5	2	Ground pin.
IN	6	1	Input pin. A small capacitor is needed from this pin to ground to assure stability. Typical input capacitor = 1.0 $\mu$ F. Both input and output capacitor grounds should be tied back to the IC ground with no significant impedance between them.
Thermal pad	Thermal pad	—	It is recommended that the SON package thermal pad be connected to ground.

**TYPICAL CHARACTERISTICS**

Over the operating temperature range of  $T_J = -40^\circ\text{C}$  to  $+125^\circ\text{C}$ ,  $V_{IN} = V_{OUT(TYP)} + 0.5\text{V}$  or  $2.2\text{V}$ , whichever is greater;  $I_{OUT} = 100\mu\text{A}$ ,  $V_{EN} = V_{VSET} = V_{IN}$ ,  $C_{OUT} = 1\mu\text{F}$ , and  $C_{IN} = 1\mu\text{F}$ , unless otherwise noted.

**LINE REGULATION**  
 $I_{OUT} = 5\text{mA}$ ,  $V_{OUT} = 1.22\text{V}$  (typ)  
 TPS78101

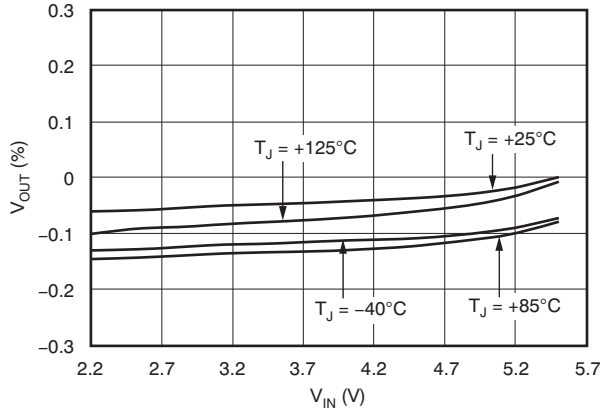

Figure 1.

**LINE REGULATION**  
 $I_{OUT} = 5\text{mA}$ ,  $V_{VSET} = 1.2\text{V}$ ,  $V_{OUT} = 2.2\text{V}$  (typ)  
 TPS781330220

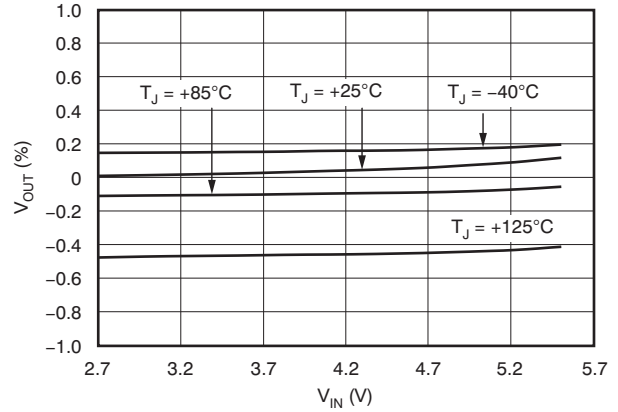

Figure 2.

**LINE REGULATION**  
 $I_{OUT} = 150\text{mA}$ ,  $V_{VSET} = 1.2\text{V}$ ,  $V_{OUT} = 2.2\text{V}$  (typ)  
 TPS781330220

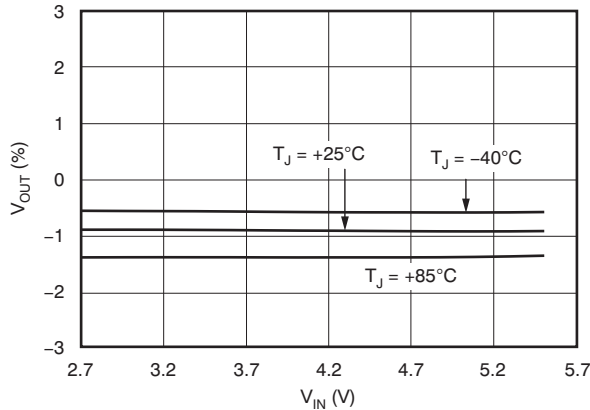

Figure 3.

**LINE REGULATION**  
 $I_{OUT} = 5\text{mA}$ ,  $V_{VSET} = 0.4\text{V}$ ,  $V_{OUT} = 3.3\text{V}$  (typ)  
 TPS781330220

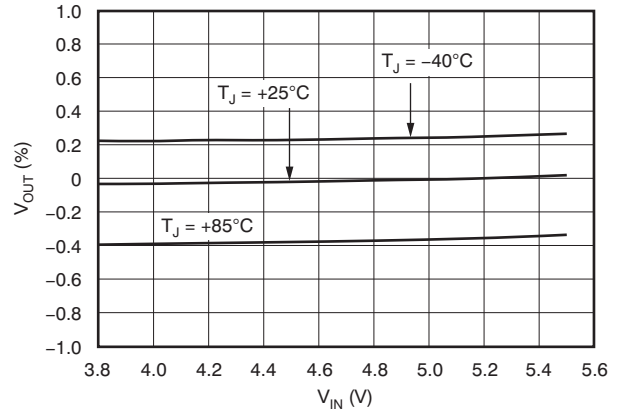

Figure 4.

**LINE REGULATION**  
 $I_{OUT} = 150\text{mA}$ ,  $V_{VSET} = 0.4\text{V}$ ,  $V_{OUT} = 3.3\text{V}$  (typ)  
 TPS781330220

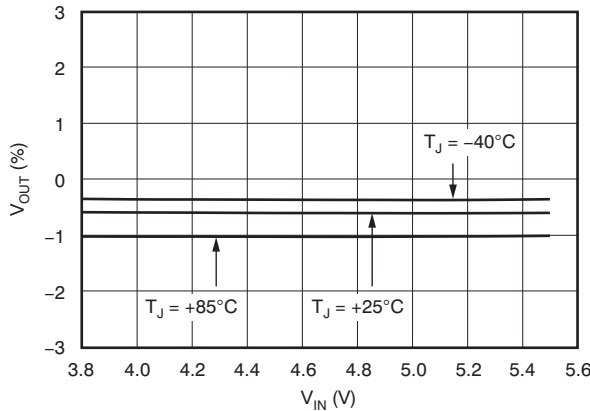

Figure 5.

**LOAD REGULATION**  
 $V_{OUT} = 3.3\text{V}$   
 TPS78101

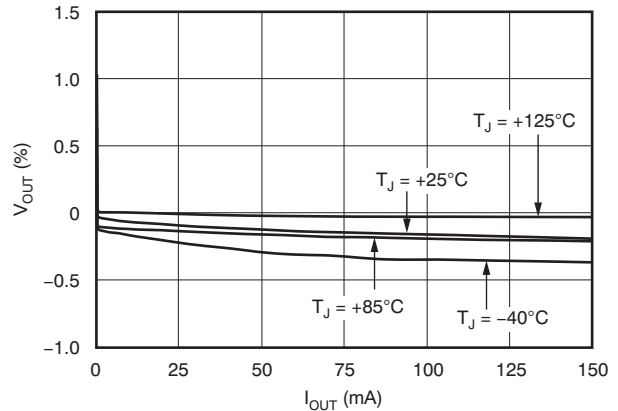

Figure 6.

**TYPICAL CHARACTERISTICS (continued)**

Over the operating temperature range of  $T_J = -40^{\circ}\text{C}$  to  $+125^{\circ}\text{C}$ ,  $V_{IN} = V_{OUT(TYP)} + 0.5\text{V}$  or  $2.2\text{V}$ , whichever is greater;  $I_{OUT} = 100\mu\text{A}$ ,  $V_{EN} = V_{VSET} = V_{IN}$ ,  $C_{OUT} = 1\mu\text{F}$ , and  $C_{IN} = 1\mu\text{F}$ , unless otherwise noted.

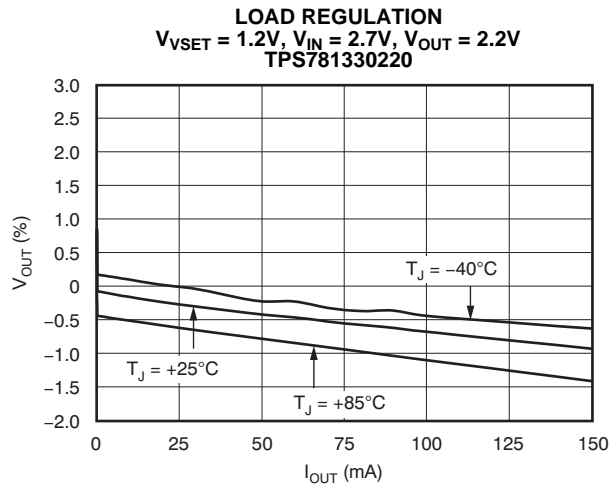

Figure 7.

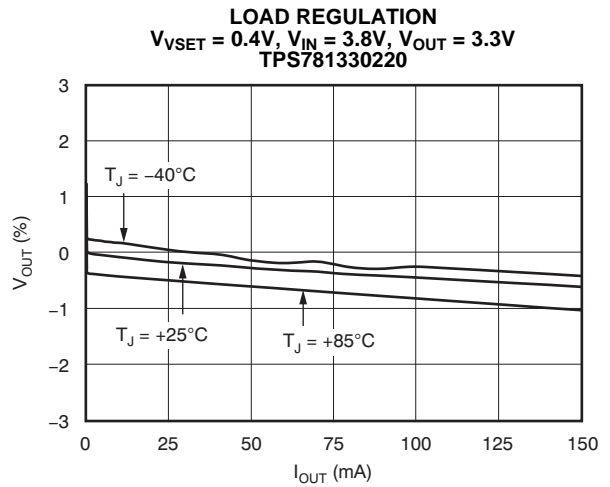

Figure 8.

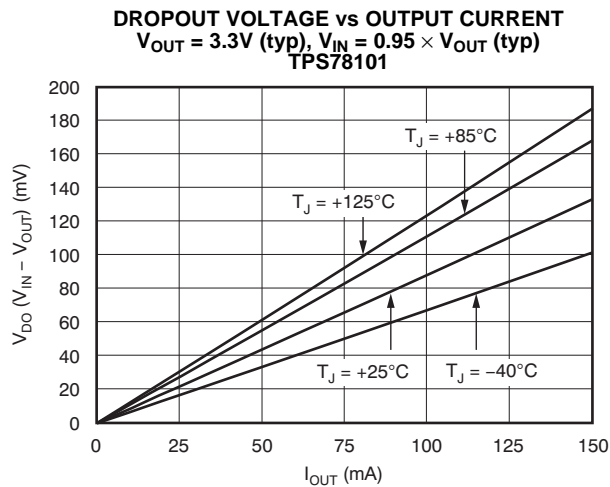

Figure 9.

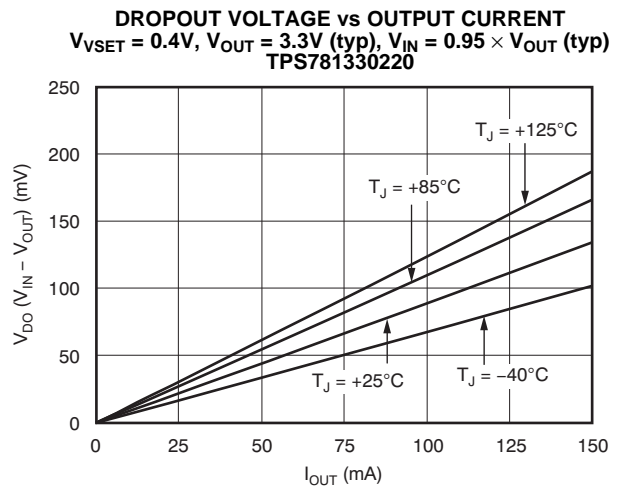

Figure 10.

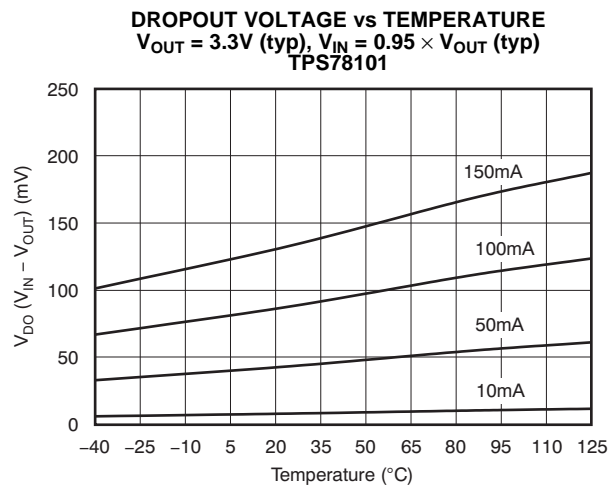

Figure 11.

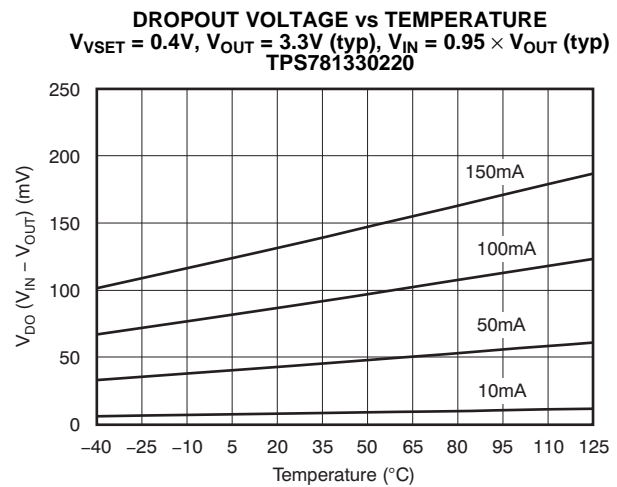

Figure 12.

**TYPICAL CHARACTERISTICS (continued)**

Over the operating temperature range of  $T_J = -40^{\circ}\text{C}$  to  $+125^{\circ}\text{C}$ ,  $V_{IN} = V_{OUT(TYP)} + 0.5\text{V}$  or  $2.2\text{V}$ , whichever is greater;  $I_{OUT} = 100\mu\text{A}$ ,  $V_{EN} = V_{VSET} = V_{IN}$ ,  $C_{OUT} = 1\mu\text{F}$ , and  $C_{IN} = 1\mu\text{F}$ , unless otherwise noted.

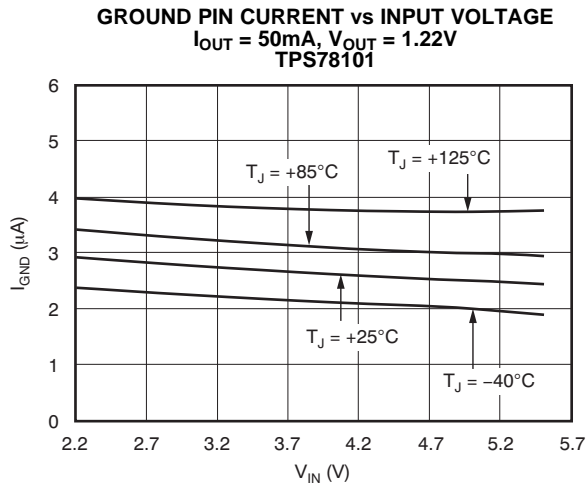

Figure 13.

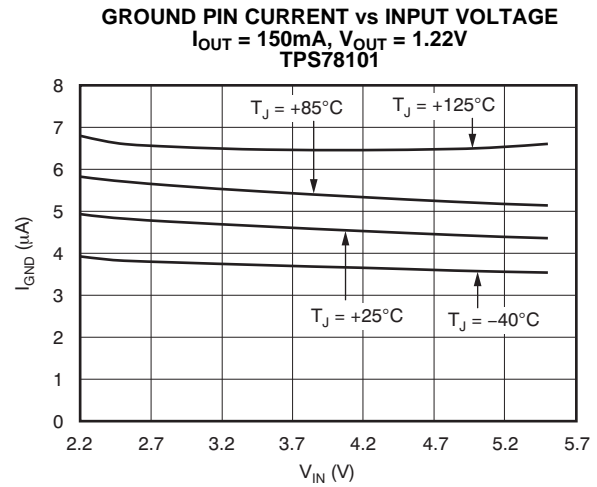

Figure 14.

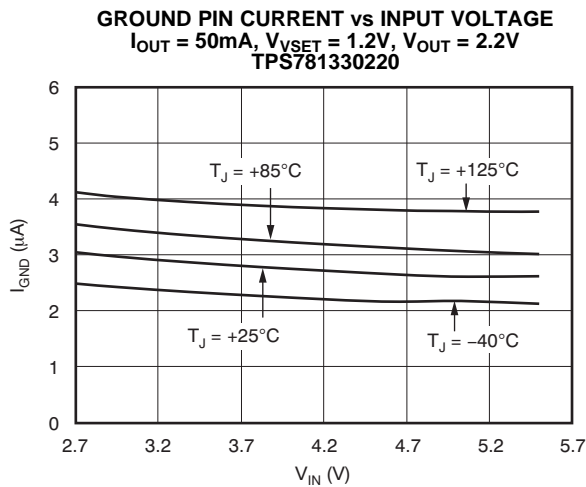

Figure 15.

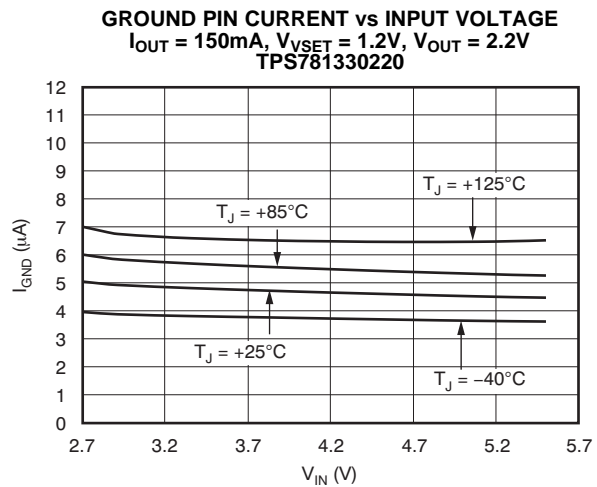

Figure 16.

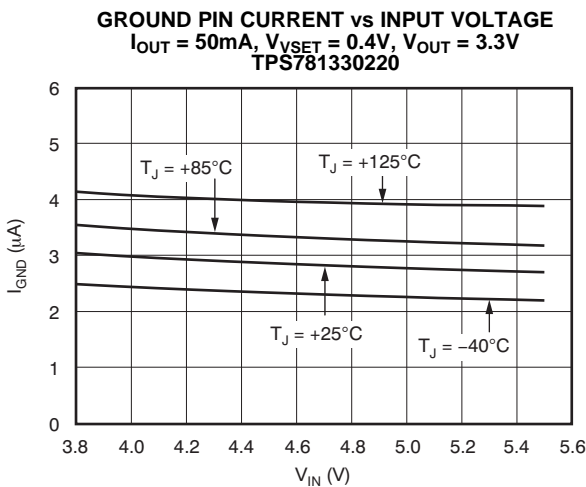

Figure 17.

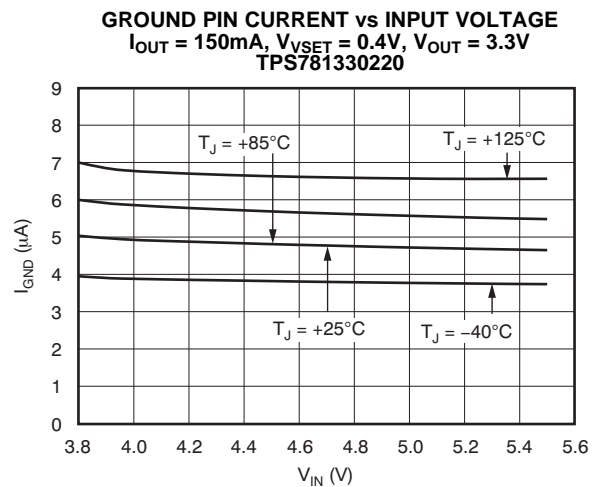

Figure 18.

**TYPICAL CHARACTERISTICS (continued)**

Over the operating temperature range of  $T_J = -40^{\circ}\text{C}$  to  $+125^{\circ}\text{C}$ ,  $V_{IN} = V_{OUT(TYP)} + 0.5\text{V}$  or  $2.2\text{V}$ , whichever is greater;  $I_{OUT} = 100\mu\text{A}$ ,  $V_{EN} = V_{VSET} = V_{IN}$ ,  $C_{OUT} = 1\mu\text{F}$ , and  $C_{IN} = 1\mu\text{F}$ , unless otherwise noted.

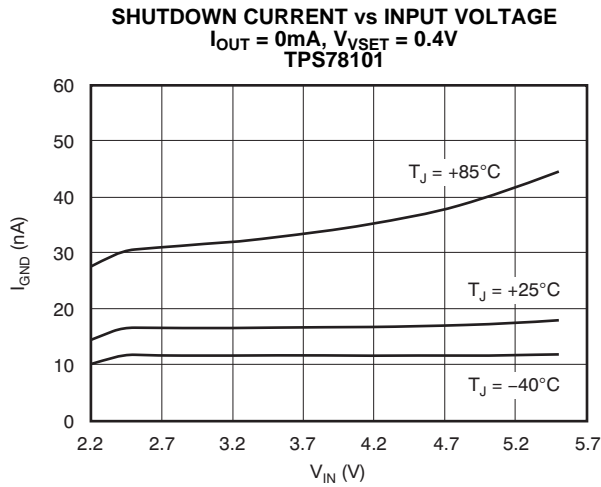

Figure 19.

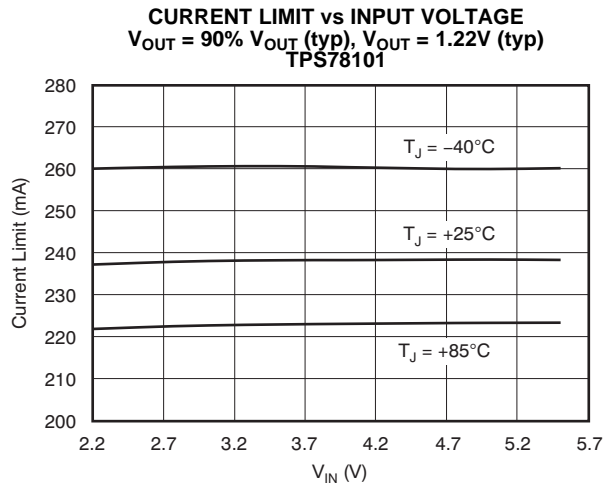

Figure 20.

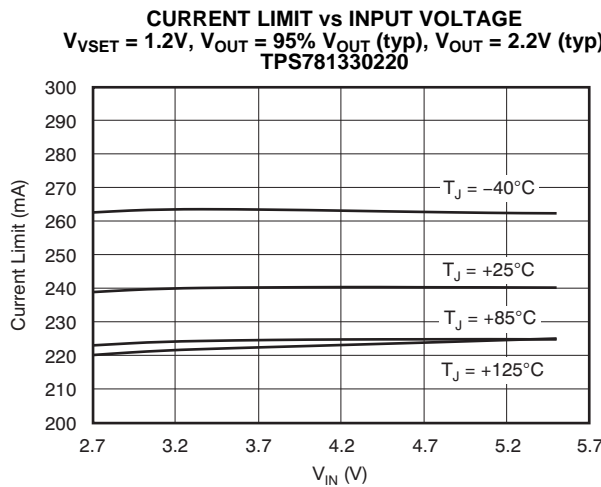

Figure 21.

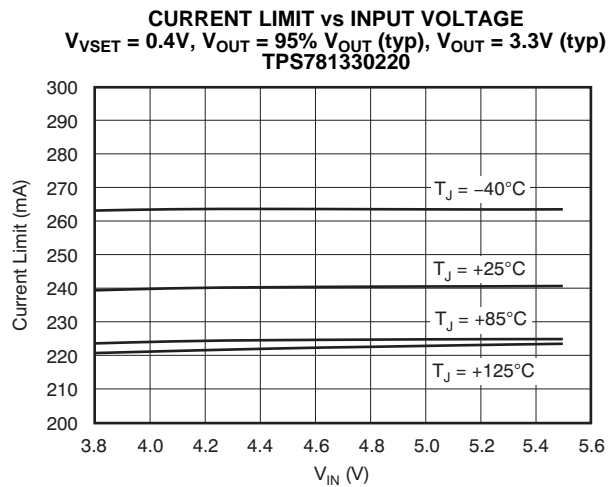

Figure 22.

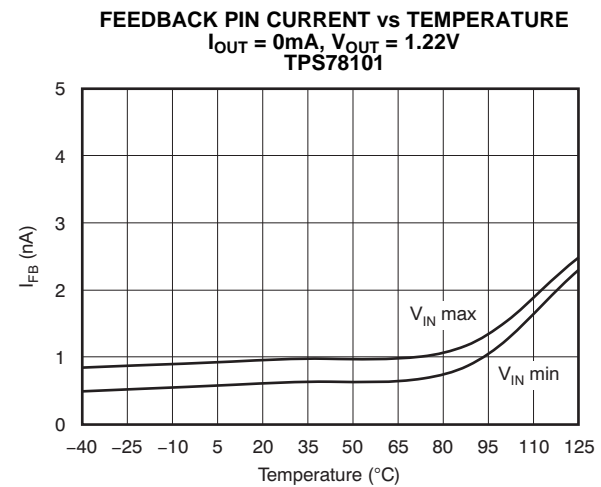

Figure 23.

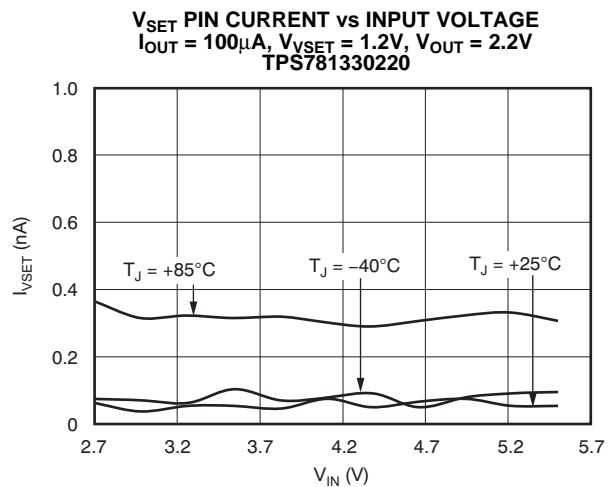

Figure 24.



**TYPICAL CHARACTERISTICS (continued)**

Over the operating temperature range of  $T_J = -40^\circ\text{C}$  to  $+125^\circ\text{C}$ ,  $V_{IN} = V_{OUT(TYP)} + 0.5\text{V}$  or  $2.2\text{V}$ , whichever is greater;  $I_{OUT} = 100\mu\text{A}$ ,  $V_{EN} = V_{VSET} = V_{IN}$ ,  $C_{OUT} = 1\mu\text{F}$ , and  $C_{IN} = 1\mu\text{F}$ , unless otherwise noted.

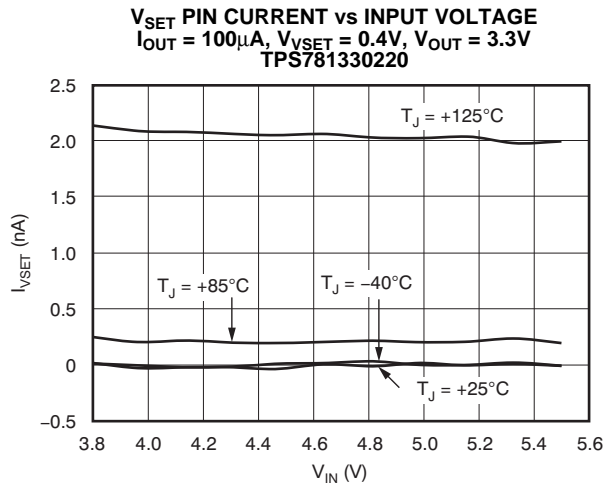

Figure 25.

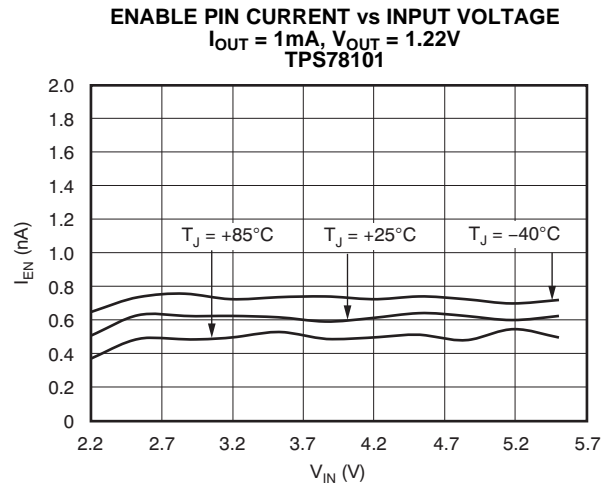

Figure 26.

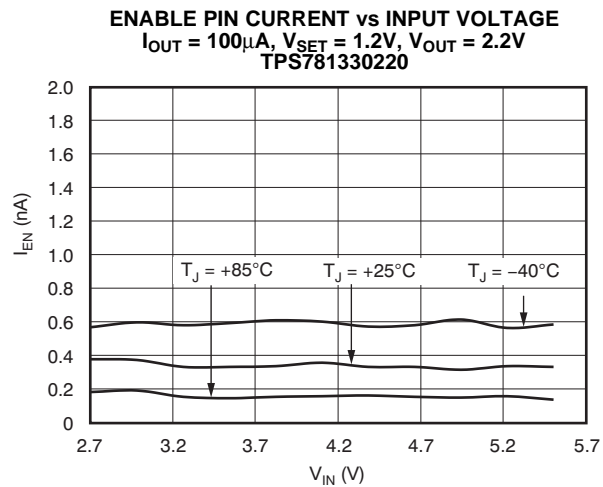

Figure 27.

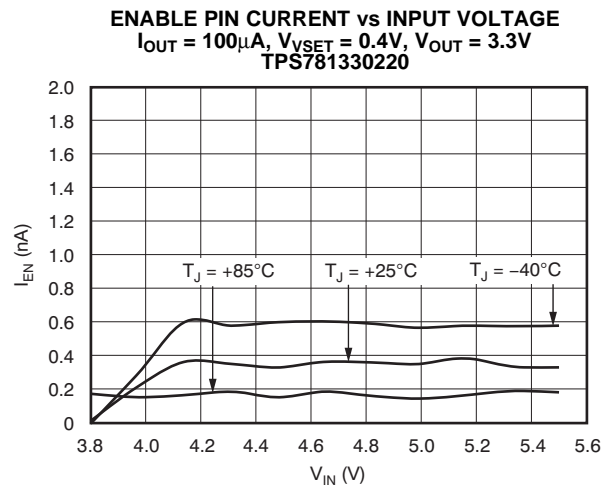

Figure 28.

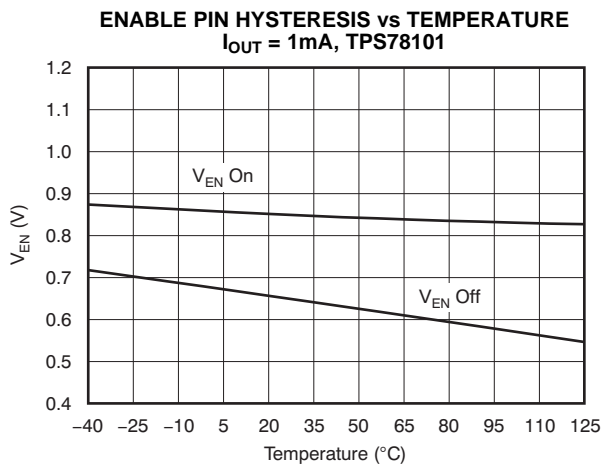

Figure 29.

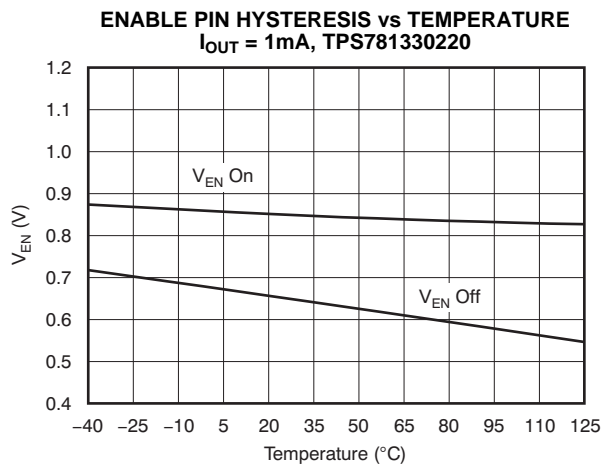

Figure 30.

**TYPICAL CHARACTERISTICS (continued)**

Over the operating temperature range of  $T_J = -40^{\circ}\text{C}$  to  $+125^{\circ}\text{C}$ ,  $V_{IN} = V_{OUT(TYP)} + 0.5\text{V}$  or  $2.2\text{V}$ , whichever is greater;  $I_{OUT} = 100\mu\text{A}$ ,  $V_{EN} = V_{VSET} = V_{IN}$ ,  $C_{OUT} = 1\mu\text{F}$ , and  $C_{IN} = 1\mu\text{F}$ , unless otherwise noted.

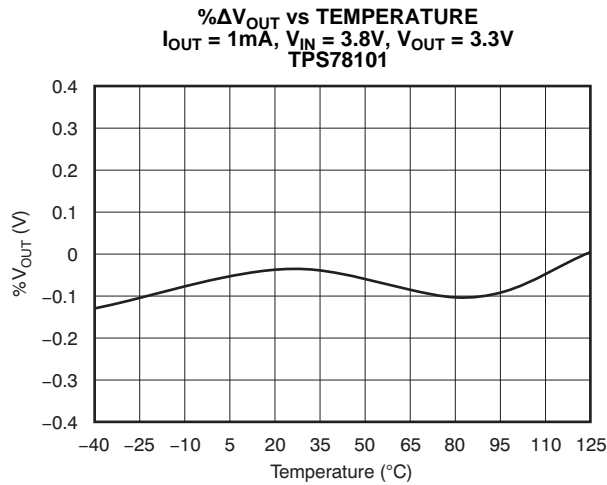

Figure 31.

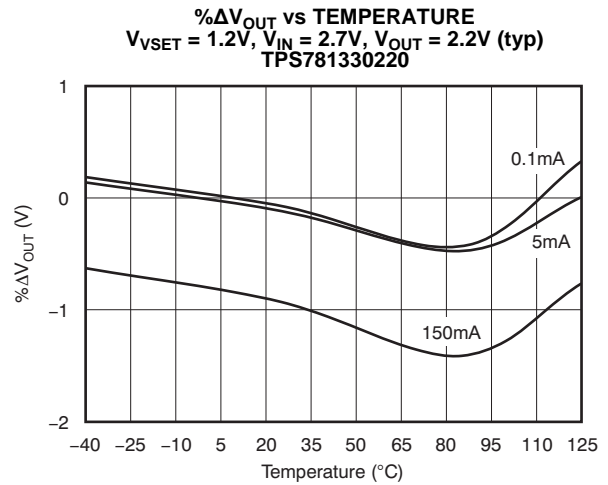

Figure 32.

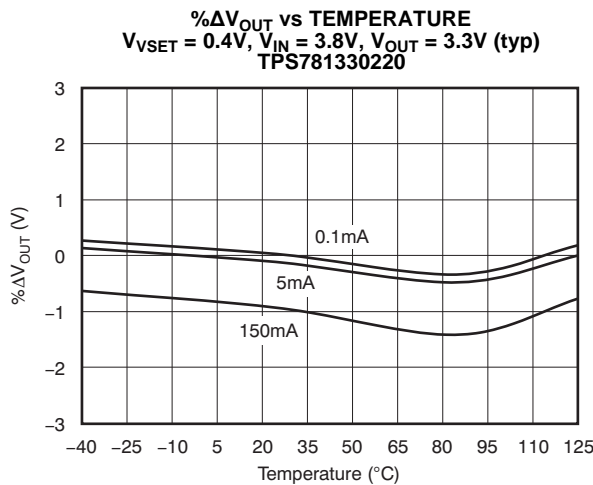

Figure 33.

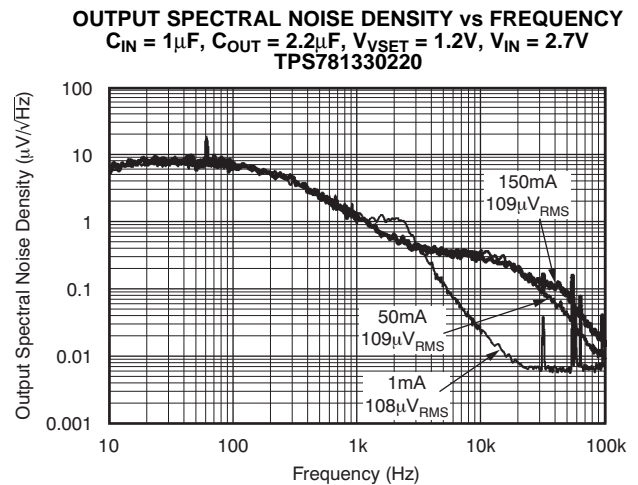

Figure 34.

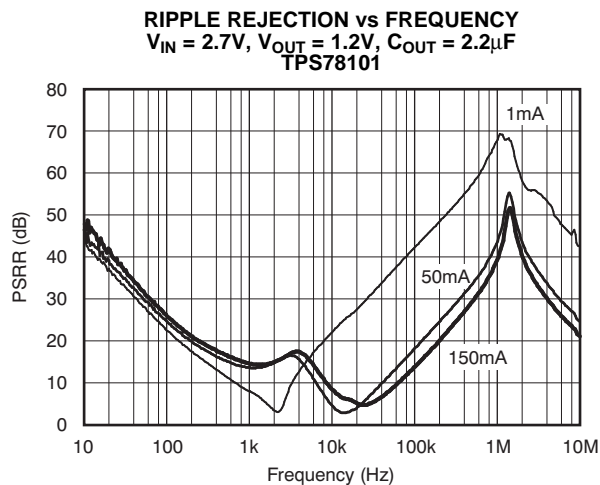

Figure 35.

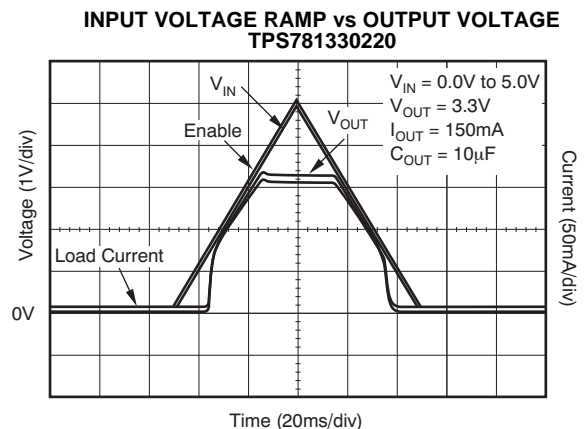
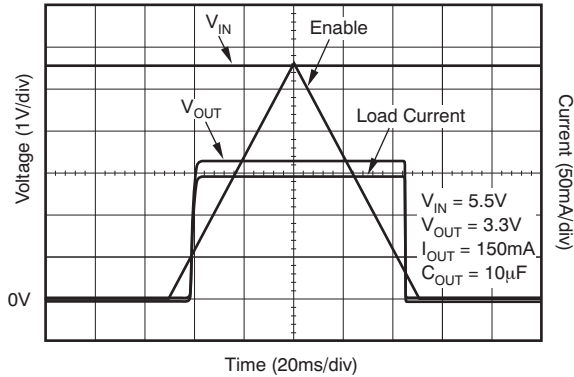

Figure 36.

**TYPICAL CHARACTERISTICS (continued)**

Over the operating temperature range of  $T_J = -40^{\circ}\text{C}$  to  $+125^{\circ}\text{C}$ ,  $V_{IN} = V_{OUT(TYP)} + 0.5\text{V}$  or  $2.2\text{V}$ , whichever is greater;  $I_{OUT} = 100\mu\text{A}$ ,  $V_{EN} = V_{VSET} = V_{IN}$ ,  $C_{OUT} = 1\mu\text{F}$ , and  $C_{IN} = 1\mu\text{F}$ , unless otherwise noted.

**OUTPUT VOLTAGE vs ENABLE (SLOW RAMP)**  
TPS781330220



**Figure 37.**

**INPUT VOLTAGE vs DELAY TO OUTPUT**  
TPS781330220

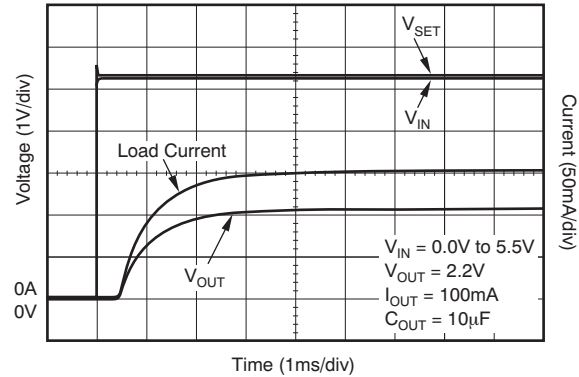

**Figure 38.**

**LINE TRANSIENT RESPONSE**  
TPS781330220

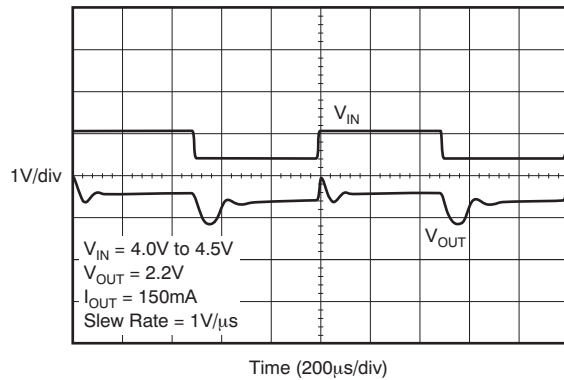

**Figure 39.**

**LINE TRANSIENT RESPONSE**  
TPS781330220

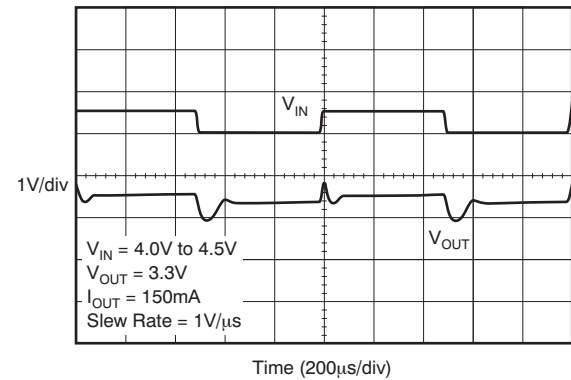

**Figure 40.**

**LOAD TRANSIENT RESPONSE**  
TPS781330220

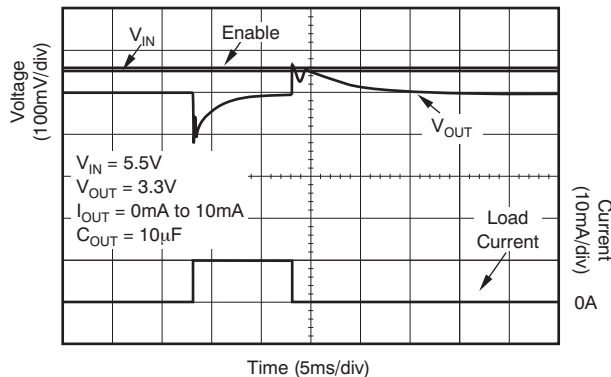

**Figure 41.**

**LOAD TRANSIENT RESPONSE**  
TPS781330220

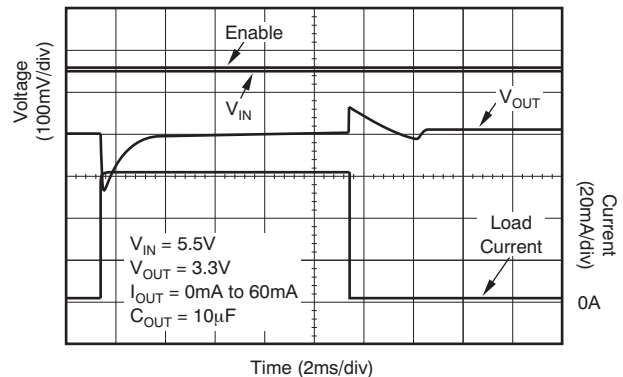
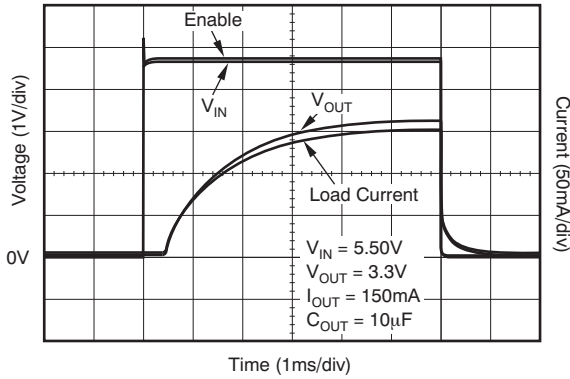

**Figure 42.**

**TYPICAL CHARACTERISTICS (continued)**

Over the operating temperature range of  $T_J = -40^{\circ}\text{C}$  to  $+125^{\circ}\text{C}$ ,  $V_{IN} = V_{OUT(TYP)} + 0.5\text{V}$  or  $2.2\text{V}$ , whichever is greater;  $I_{OUT} = 100\mu\text{A}$ ,  $V_{EN} = V_{VSET} = V_{IN}$ ,  $C_{OUT} = 1\mu\text{F}$ , and  $C_{IN} = 1\mu\text{F}$ , unless otherwise noted.

**ENABLE PIN vs OUTPUT VOLTAGE RESPONSE AND OUTPUT CURRENT  
TPS781330220**



**Figure 43.**

**ENABLE PIN vs OUTPUT VOLTAGE DELAY  
TPS781330220**

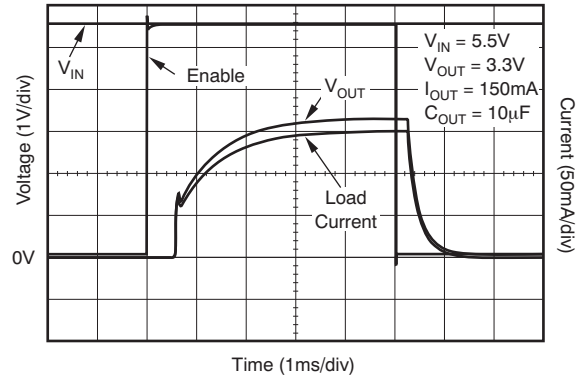

**Figure 44.**

**V<sub>SET</sub> PIN TOGGLE  
TPS781330220**

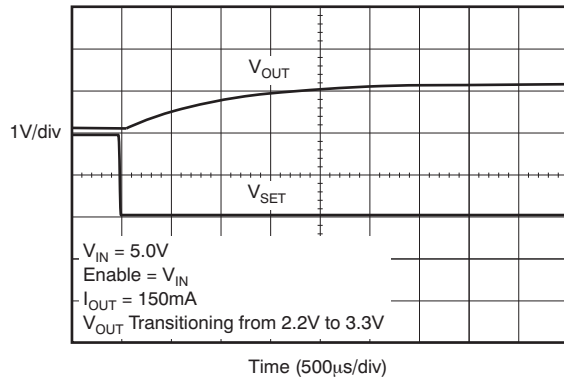

**Figure 45.**

**V<sub>SET</sub> PIN TOGGLE  
TPS781330220**

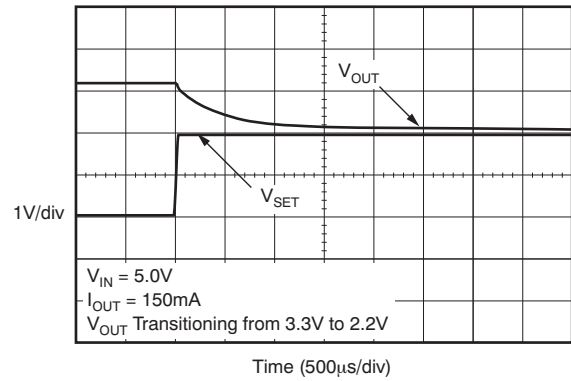

**Figure 46.**

**V<sub>SET</sub> PIN TOGGLE (SLOW RAMP)  
TPS781330220**

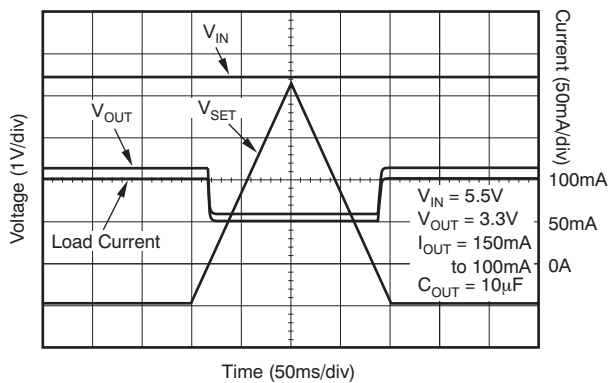
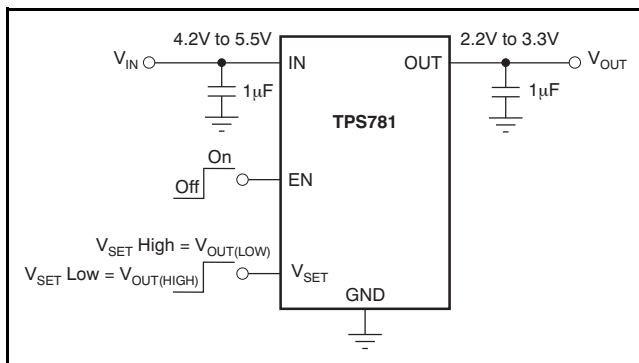

**Figure 47.**

## APPLICATION INFORMATION

### APPLICATION EXAMPLES

The TPS781 series of LDOs typically take less than 800µs to transition from a lower voltage of 2.2V to a higher voltage of 3.3V under an output load of 150mA; see [Figure 45](#). Additionally, the TPS781 series contain active pull-down circuitry that automatically pulls charge out of the voltage capacitor to transition the output voltage from the higher voltage to the lower voltage, even with no load connected. Output voltage overshoots and undershoots are minimal under this load condition. The TPS781 series typically take less than 800µs to transition from  $V_{SET}$  low (3.3V to 2.2V), or  $V_{SET}$  high (2.2V to 3.3V); see [Figure 45](#) and [Figure 46](#). Both output states of the TPS781 series are factory-programmable between 1.5V to 4.2V. Note that during startup or steady-state conditions, it is important that the EN pin and  $V_{SET}$  pin voltages never exceed  $V_{IN} + 0.3V$ .



**Figure 48. Typical Application Circuit**

The TPS781 series is also used effectively in dynamic voltage scaling (DVS) applications. DVS applications are required to dynamically switch between a high operational voltage to a low standby voltage in order to reduce power consumption. Modern multimillion gate microprocessors fabricated with the latest sub-micron processes save power by transitioning to a lower voltage to reduce leakage currents while maintaining content. This architecture enables the microprocessor to transition quickly into an operational state (wake up) without requiring a reload of the states from external memory, or a reboot.

### Programming the TPS78101 Adjustable LDO Regulator

The output voltage of the TPS78101 adjustable regulator is programmed using an external resistor divider as shown in [Figure 49](#). The output voltage operating range is 1.2V to 5.1V, and is calculated using [Equation 1](#):

$$V_{OUT} = V_{FB} \times \left(1 + \frac{R_1}{R_2}\right) \quad (1)$$

Where:

$V_{FB} = 1.216V$  typ (the internal reference voltage)

Resistors  $R_1$  and  $R_2$  should be chosen for approximately 1.2µA divider current. Lower value resistors can be used for improved noise performance, but the solution consumes more power. Higher resistor values should be avoided as leakage current into/out of FB across  $R_1/R_2$  creates an offset voltage that artificially increases/decreases the feedback voltage and thus erroneously decreases/increases  $V_{OUT}$ . [Table 2](#) lists several common output voltages and resistor values. The recommended design procedure is to choose  $R_2 = 1M\Omega$  to set the divider current at 1.2µA, and then calculate  $R_1$  using [Equation 2](#):

$$R_1 = \left(\frac{V_{OUT}}{V_{FB}} - 1\right) \times R_2 \quad (2)$$

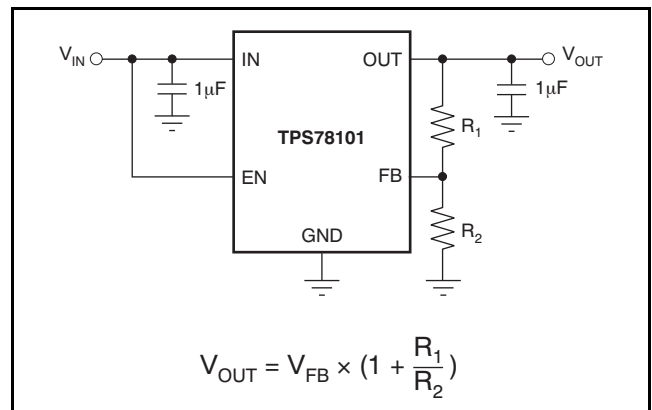

**Figure 49. TPS78101 Adjustable LDO Regulator Programming**

**Table 2. Output Voltage Programming Guide**

OUTPUT VOLTAGE	$R_1$	$R_2$
1.8V	0.499MΩ	1MΩ
2.8V	1.33MΩ	1MΩ
5.0V	3.16MΩ	1MΩ

**Powering the MSP430 Microcontroller**

Several versions of the TPS781 are ideal for powering the MSP430 microcontroller. Table 3 shows potential applications of some voltage versions.

**Table 3. Typical MSP430 Applications**

DEVICE	V <sub>OUT(HIGH)</sub> (TYP)	V <sub>OUT(LOW)</sub> (TYP)	APPLICATION
TPS781360200	3.6V	2.0V	V <sub>OUT, MIN</sub> > 1.800V required by many MSP430s. Allows lowest power consumption operation.
TPS781360220	3.6V	2.2V	V <sub>OUT, MIN</sub> > 2.200V required by some MSP430s FLASH operation.
TPS781360300	3.6V	3.0V	V <sub>OUT, MIN</sub> > 2.700V required by some MSP430s FLASH operation.
TPS781360220	3.6V	2.2V	V <sub>OUT, MIN</sub> < 3.600V required by some MSP430s. Allows highest speed operation.

The TPS781 family offers many output voltage versions to allow designers to optimize the supply voltage for the processing speed required of the MSP430. This flexible architecture minimizes the supply current consumed by the particular MSP430 application. The MSP430 total system power can be reduced by substituting the 1µA I<sub>Q</sub> TPS781 series LDO in place of an existing, older-technology LDO. Additionally, DVS allows for increasing the clock speed in active mode (MSP430 V<sub>CC</sub> = 3.6V). The 3.6V V<sub>CC</sub> reduces the MSP430 time in active mode. In low-power mode, MSP430 system power can be further reduced by lowering the MSP430 V<sub>CC</sub> to 2.2V in sleep mode.

Key features of the TPS781 series are an ultralow quiescent current (1µA), DVS, and miniaturized packaging. The TPS781 family are available in SON-6 and TSOT-23 packages. Figure 50 shows a typical MSP430 circuit powered by an LDO without DVS. Figure 51 is an MSP430 circuit using a TPS781 LDO that incorporates an integrated DVS, thus simplifying the circuit design. In a circuit without DVS, as Figure 50 illustrates, V<sub>CC</sub> is always at 3.0V. When the MSP430 goes into sleep mode, V<sub>CC</sub> remains at 3.0V; if DVS is applied, V<sub>CC</sub> could be reduced in sleep mode. In Figure 51, the TPS781 LDO with integrated DVS maintains 3.6V V<sub>CC</sub> until a logic high signal from the MSP430 forces V<sub>OUT</sub> to level shift V<sub>OUT</sub> from 3.6V down to 2.2V; thus reducing power in sleep mode.

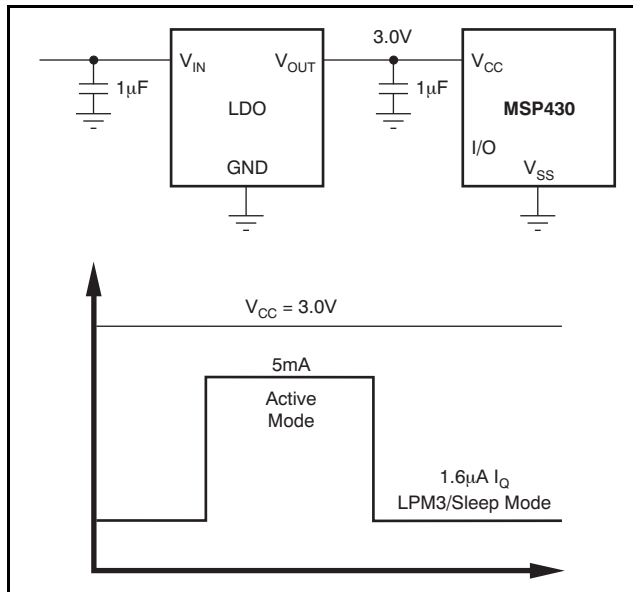

**Figure 50. Typical LDO without DVS**

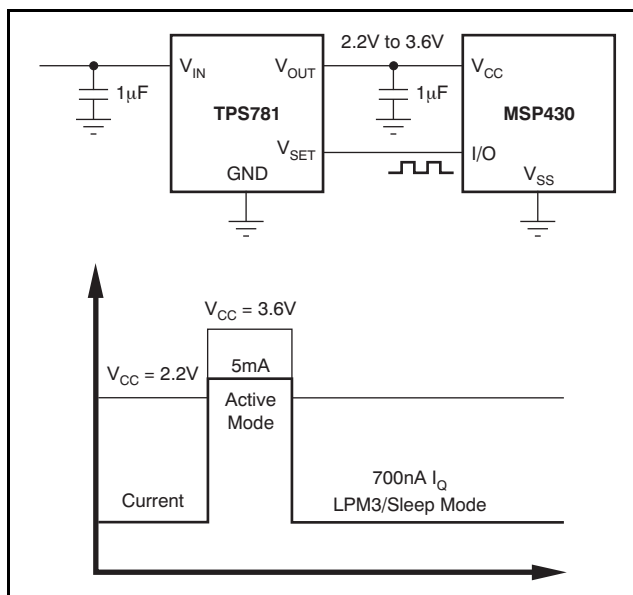

**Figure 51. TPS781 with Integrated DVS**

The other benefit of DVS is that it allows a higher V<sub>CC</sub> voltage on the MSP430, increasing the clock speed and reducing the active mode dwell time.

## INPUT AND OUTPUT CAPACITOR REQUIREMENTS

Although an input capacitor is not required for stability, it is good analog design practice to connect a 0.1µF to 1.0µF low equivalent series resistance (ESR) capacitor across the input supply near the regulator. This capacitor counteracts reactive input sources and improves transient response, noise rejection, and ripple rejection. A higher-value capacitor may be necessary if large, fast rise-time load transients are anticipated, or if the device is not located near the power source. If source impedance is not sufficiently low, a 0.1µF input capacitor may be necessary to ensure stability.

The TPS781 series are designed to be stable with standard ceramic capacitors with values of 1.0µF or larger at the output. X5R- and X7R-type capacitors are best because they have minimal variation in value and ESR over temperature. Maximum ESR should be less than 1.0Ω. With tolerance and dc bias effects, the minimum capacitance to ensure stability is 1µF.

## BOARD LAYOUT RECOMMENDATIONS TO IMPROVE PSRR AND NOISE PERFORMANCE

To improve ac performance (such as PSRR, output noise, and transient response), it is recommended that the printed circuit board (PCB) be designed with separate ground planes for  $V_{IN}$  and  $V_{OUT}$ , with each ground plane connected only at the GND pin of the device. In addition, the ground connection for the output capacitor should connect directly to the GND pin of the device. High ESR capacitors may degrade PSRR.

## INTERNAL CURRENT LIMIT

The TPS781 is internally current-limited to protect the regulator during fault conditions. During current limit, the output sources a fixed amount of current that is largely independent of output voltage. For reliable operation, the device should not be operated in a current limit state for extended periods of time.

The PMOS pass element in the TPS781 series has a built-in body diode that conducts current when the voltage at OUT exceeds the voltage at IN. This current is not limited, so if extended reverse voltage operation is anticipated, external limiting to 5% of rated output current may be appropriate.

## SHUTDOWN

The enable pin (EN) is active high and is compatible with standard and low-voltage CMOS levels. When shutdown capability is not required, EN should be connected to the IN pin, as shown in Figure 52. Figure 53 shows both EN and  $V_{SET}$  connected to IN. The TPS781 series, with internal active output pull-down circuitry, discharges the output to within 5%  $V_{OUT}$  with a time ( $t$ ) shown in Equation 3:

$$t = 3 \left[ \frac{10k\Omega \times R_L}{10k\Omega + R_L} \right] \times C_{OUT} \quad (3)$$

Where:

$R_L$  = output load resistance

$C_{OUT}$  = output capacitance

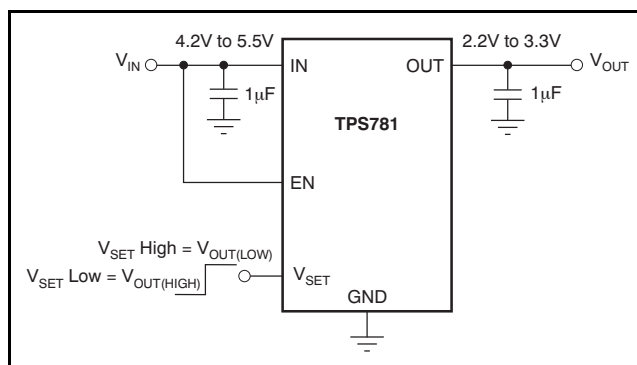

**Figure 52. Circuit Showing EN Tied High when Shutdown Capability is Not Required**

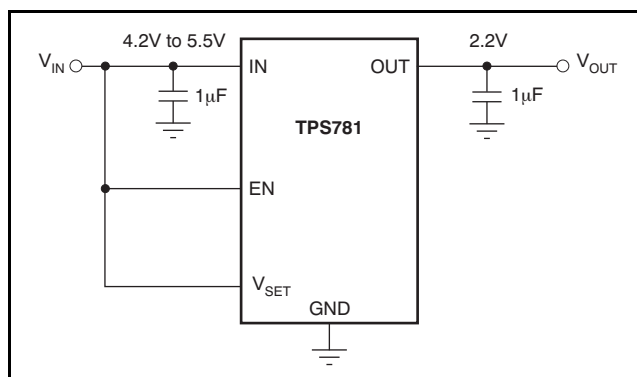

**Figure 53. Circuit to Tie Both EN and  $V_{SET}$  High**

## DROPOUT VOLTAGE

The TPS781 series use a PMOS pass transistor to achieve low dropout. When  $(V_{IN} - V_{OUT})$  is less than the dropout voltage ( $V_{DO}$ ), the PMOS pass device is the linear region of operation and the input-to-output resistance is the  $R_{DS(ON)}$  of the PMOS pass element.  $V_{DO}$  approximately scales with output current because the PMOS device behaves like a resistor in dropout. As with any linear regulator, PSRR and transient response are degraded as  $(V_{IN} - V_{OUT})$  approaches dropout. This effect is shown in the Typical Characteristics section. Refer to application report [SLVA207](#), *Understanding LDO Dropout*, available for download from [www.ti.com](http://www.ti.com).

## TRANSIENT RESPONSE

As with any regulator, increasing the size of the output capacitor reduces over/undershoot magnitude but increases duration of the transient response. For more information, see [Figure 42](#).

## ACTIVE $V_{OUT}$ PULL-DOWN

In the TPS781 series, the active pull-down discharges  $V_{OUT}$  when the device is off. However, the input voltage must be greater than 2.2V for the active pull-down to work.

## MINIMUM LOAD

The TPS781 series are stable with no output load. Traditional PMOS LDO regulators suffer from lower loop gain at very light output loads. The TPS781 employs an innovative, low-current circuit under very light or no-load conditions, resulting in improved output voltage regulation performance down to zero output current. See [Figure 41](#) for the load transient response.



## THERMAL INFORMATION

### THERMAL PROTECTION

Thermal protection disables the output when the junction temperature rises to approximately +160°C, allowing the device to cool. Once the junction temperature cools to approximately +140°C, the output circuitry is enabled. Depending on power dissipation, thermal resistance, and ambient temperature, the thermal protection circuit may cycle on and off again. This cycling limits the dissipation of the regulator, protecting it from damage as a result of overheating.

Any tendency to activate the thermal protection circuit indicates excessive power dissipation or an inadequate heatsink. For reliable operation, junction temperature should be limited to +125°C maximum. To estimate the margin of safety in a complete design (including heatsink), increase the ambient temperature until the thermal protection is triggered; use worst-case loads and signal conditions. For good reliability, thermal protection should trigger at least +35°C above the maximum expected ambient condition of your particular application. This configuration produces a worst-case junction temperature of +125°C at the highest expected ambient temperature and worst-case load.

The internal protection circuitry of the TPS781 series has been designed to protect against overload conditions. However, it is not intended to replace proper heatsinking. Continuously running the TPS781 series into thermal shutdown degrades device reliability.

### POWER DISSIPATION

The ability to remove heat from the die is different for each package type, presenting different considerations in the PCB layout. The PCB area around the device that is free of other components moves the heat from the device to the ambient air. Performance data for JEDEC low- and high-K boards are given in the [Dissipation Ratings](#) table. Using heavier copper increases the effectiveness in removing heat from the device. The addition of plated through-holes to heat-dissipating layers also improves the heatsink effectiveness. Power dissipation depends on input voltage and load conditions. Power dissipation ( $P_D$ ) is equal to the product of the output current times the voltage drop across the output pass element ( $V_{IN}$  to  $V_{OUT}$ ), as shown in [Equation 4](#):

$$P_D = (V_{IN} - V_{OUT}) \times I_{OUT} \quad (4)$$

### PACKAGE MOUNTING

Solder pad footprint recommendations for the TPS781 series are available from the Texas Instruments web site at [www.ti.com](http://www.ti.com) through the [TPS781 series product folders](#).

**PACKAGING INFORMATION**

Orderable Device	Status (1)	Package Type	Package Drawing	Pins	Package Qty	Eco Plan (2)	Lead finish/ Ball material (6)	MSL Peak Temp (3)	Op Temp (°C)	Device Marking (4/5)	Samples
TPS78101DDCR	ACTIVE	SOT-23-THIN	DDC	5	3000	RoHS & Green	NIPDAU	Level-2-260C-1 YEAR	-40 to 125	CEB	<a href="#">Samples</a>
TPS78101DDCT	ACTIVE	SOT-23-THIN	DDC	5	250	RoHS & Green	NIPDAU	Level-2-260C-1 YEAR	-40 to 125	CEB	<a href="#">Samples</a>
TPS78101DRVR	ACTIVE	WSON	DRV	6	3000	RoHS & Green	NIPDAU	Level-1-260C-UNLIM	-40 to 125	CEB	<a href="#">Samples</a>
TPS78101DRVT	ACTIVE	WSON	DRV	6	250	RoHS & Green	NIPDAU   NIPDAUAG	Level-1-260C-UNLIM	-40 to 125	CEB	<a href="#">Samples</a>
TPS781250200DDCR	ACTIVE	SOT-23-THIN	DDC	5	3000	RoHS & Green	NIPDAU	Level-2-260C-1 YEAR	-40 to 125	SAN	<a href="#">Samples</a>
TPS781250200DDCT	ACTIVE	SOT-23-THIN	DDC	5	250	RoHS & Green	NIPDAU	Level-2-260C-1 YEAR	-40 to 125	SAN	<a href="#">Samples</a>
TPS781330220DDCR	ACTIVE	SOT-23-THIN	DDC	5	3000	RoHS & Green	NIPDAU	Level-2-260C-1 YEAR	-40 to 125	CED	<a href="#">Samples</a>
TPS781330220DDCRG4	ACTIVE	SOT-23-THIN	DDC	5	3000	TBD	Call TI	Call TI	-40 to 125		<a href="#">Samples</a>
TPS781330220DDCT	ACTIVE	SOT-23-THIN	DDC	5	250	RoHS & Green	NIPDAU	Level-2-260C-1 YEAR	-40 to 125	CED	<a href="#">Samples</a>
TPS781330220DRVR	ACTIVE	WSON	DRV	6	3000	RoHS & Green	NIPDAU   NIPDAUAG	Level-1-260C-UNLIM	-40 to 125	CED	<a href="#">Samples</a>
TPS781330220DRVT	ACTIVE	WSON	DRV	6	250	RoHS & Green	NIPDAU   NIPDAUAG	Level-1-260C-UNLIM	-40 to 125	CED	<a href="#">Samples</a>

(1) The marketing status values are defined as follows:

**ACTIVE:** Product device recommended for new designs.

**LIFEBUY:** TI has announced that the device will be discontinued, and a lifetime-buy period is in effect.

**NRND:** Not recommended for new designs. Device is in production to support existing customers, but TI does not recommend using this part in a new design.

**PREVIEW:** Device has been announced but is not in production. Samples may or may not be available.

**OBSELETE:** TI has discontinued the production of the device.

(2) **RoHS:** TI defines "RoHS" to mean semiconductor products that are compliant with the current EU RoHS requirements for all 10 RoHS substances, including the requirement that RoHS substance do not exceed 0.1% by weight in homogeneous materials. Where designed to be soldered at high temperatures, "RoHS" products are suitable for use in specified lead-free processes. TI may reference these types of products as "Pb-Free".

**RoHS Exempt:** TI defines "RoHS Exempt" to mean products that contain lead but are compliant with EU RoHS pursuant to a specific EU RoHS exemption.

**Green:** TI defines "Green" to mean the content of Chlorine (Cl) and Bromine (Br) based flame retardants meet JS709B low halogen requirements of <=1000ppm threshold. Antimony trioxide based flame retardants must also meet the <=1000ppm threshold requirement.

(3) MSL, Peak Temp. - The Moisture Sensitivity Level rating according to the JEDEC industry standard classifications, and peak solder temperature.

- (4) There may be additional marking, which relates to the logo, the lot trace code information, or the environmental category on the device.
- (5) Multiple Device Markings will be inside parentheses. Only one Device Marking contained in parentheses and separated by a "~" will appear on a device. If a line is indented then it is a continuation of the previous line and the two combined represent the entire Device Marking for that device.
- (6) Lead finish/Ball material - Orderable Devices may have multiple material finish options. Finish options are separated by a vertical ruled line. Lead finish/Ball material values may wrap to two lines if the finish value exceeds the maximum column width.

**Important Information and Disclaimer:**The information provided on this page represents TI's knowledge and belief as of the date that it is provided. TI bases its knowledge and belief on information provided by third parties, and makes no representation or warranty as to the accuracy of such information. Efforts are underway to better integrate information from third parties. TI has taken and continues to take reasonable steps to provide representative and accurate information but may not have conducted destructive testing or chemical analysis on incoming materials and chemicals. TI and TI suppliers consider certain information to be proprietary, and thus CAS numbers and other limited information may not be available for release.

In no event shall TI's liability arising out of such information exceed the total purchase price of the TI part(s) at issue in this document sold by TI to Customer on an annual basis.

## TAPE AND REEL INFORMATION



### QUADRANT ASSIGNMENTS FOR PIN 1 ORIENTATION IN TAPE



\*All dimensions are nominal

Device	Package Type	Package Drawing	Pins	SPQ	Reel Diameter (mm)	Reel Width W1 (mm)	A0 (mm)	B0 (mm)	K0 (mm)	P1 (mm)	W (mm)	Pin1 Quadrant
TPS78101DDCR	SOT-23-THIN	DDC	5	3000	179.0	8.4	3.2	3.2	1.4	4.0	8.0	Q3
TPS78101DDCT	SOT-23-THIN	DDC	5	250	179.0	8.4	3.2	3.2	1.4	4.0	8.0	Q3
TPS78101DRVR	WSON	DRV	6	3000	178.0	8.4	2.25	2.25	1.0	4.0	8.0	Q2
TPS78101DRVR	WSON	DRV	6	3000	179.0	8.4	2.2	2.2	1.2	4.0	8.0	Q2
TPS78101DRVT	WSON	DRV	6	250	179.0	8.4	2.2	2.2	1.2	4.0	8.0	Q2
TPS78101DRVT	WSON	DRV	6	250	178.0	8.4	2.25	2.25	1.0	4.0	8.0	Q2
TPS781250200DDCR	SOT-23-THIN	DDC	5	3000	180.0	8.4	3.2	3.2	1.4	4.0	8.0	Q3
TPS781250200DDCT	SOT-23-THIN	DDC	5	250	179.0	8.4	3.2	3.2	1.4	4.0	8.0	Q3
TPS781330220DDCR	SOT-23-THIN	DDC	5	3000	179.0	8.4	3.2	3.2	1.4	4.0	8.0	Q3
TPS781330220DDCT	SOT-23-THIN	DDC	5	250	179.0	8.4	3.2	3.2	1.4	4.0	8.0	Q3
TPS781330220DRVR	WSON	DRV	6	3000	178.0	8.4	2.25	2.25	1.0	4.0	8.0	Q2
TPS781330220DRVR	WSON	DRV	6	3000	179.0	8.4	2.2	2.2	1.2	4.0	8.0	Q2
TPS781330220DRVT	WSON	DRV	6	250	178.0	8.4	2.25	2.25	1.0	4.0	8.0	Q2
TPS781330220DRVT	WSON	DRV	6	250	179.0	8.4	2.2	2.2	1.2	4.0	8.0	Q2

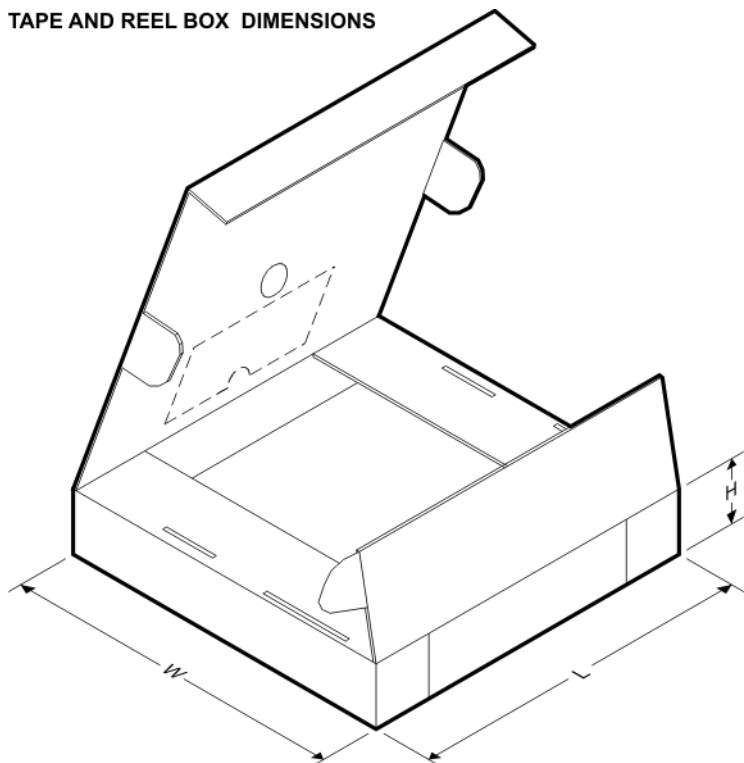
**TAPE AND REEL BOX DIMENSIONS**

\*All dimensions are nominal

Device	Package Type	Package Drawing	Pins	SPQ	Length (mm)	Width (mm)	Height (mm)
TPS78101DDCR	SOT-23-THIN	DDC	5	3000	213.0	191.0	35.0
TPS78101DDCT	SOT-23-THIN	DDC	5	250	213.0	191.0	35.0
TPS78101DRVR	WSON	DRV	6	3000	205.0	200.0	33.0
TPS78101DRVR	WSON	DRV	6	3000	200.0	183.0	25.0
TPS78101DRVT	WSON	DRV	6	250	203.0	203.0	35.0
TPS78101DRVT	WSON	DRV	6	250	205.0	200.0	33.0
TPS781250200DDCR	SOT-23-THIN	DDC	5	3000	213.0	191.0	35.0
TPS781250200DDCT	SOT-23-THIN	DDC	5	250	213.0	191.0	35.0
TPS781330220DDCR	SOT-23-THIN	DDC	5	3000	213.0	191.0	35.0
TPS781330220DDCT	SOT-23-THIN	DDC	5	250	213.0	191.0	35.0
TPS781330220DRVR	WSON	DRV	6	3000	205.0	200.0	33.0
TPS781330220DRVR	WSON	DRV	6	3000	203.0	203.0	35.0
TPS781330220DRVT	WSON	DRV	6	250	205.0	200.0	33.0
TPS781330220DRVT	WSON	DRV	6	250	200.0	183.0	25.0

## GENERIC PACKAGE VIEW

DRV 6

WSON - 0.8 mm max height

PLASTIC SMALL OUTLINE - NO LEAD



Images above are just a representation of the package family, actual package may vary.  
Refer to the product data sheet for package details.

4206925/F

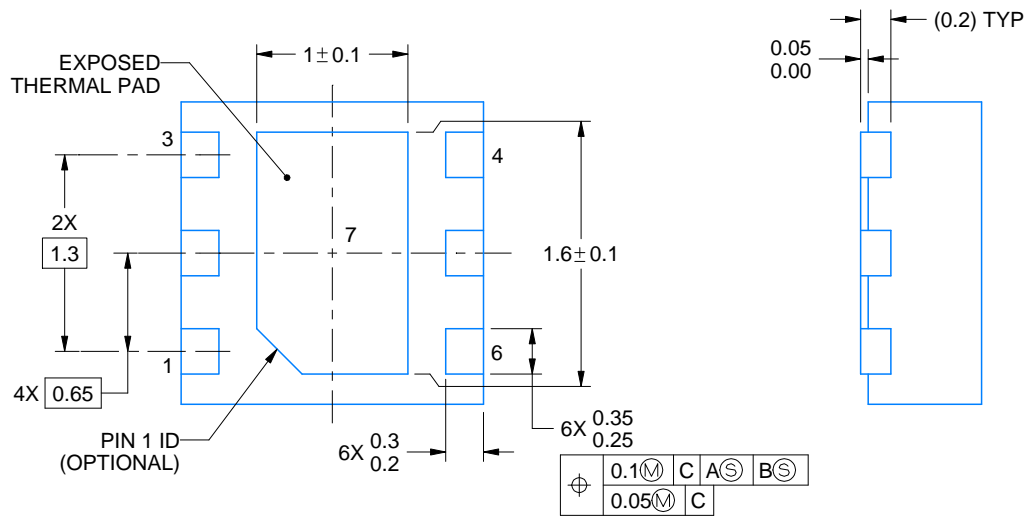
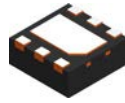

4222173/B 04/2018

NOTES:

1. All linear dimensions are in millimeters. Any dimensions in parenthesis are for reference only. Dimensioning and tolerancing per ASME Y14.5M.
2. This drawing is subject to change without notice.
3. The package thermal pad must be soldered to the printed circuit board for thermal and mechanical performance.

# EXAMPLE BOARD LAYOUT

DRV0006A

WSON - 0.8 mm max height

PLASTIC SMALL OUTLINE - NO LEAD



LAND PATTERN EXAMPLE  
SCALE:25X

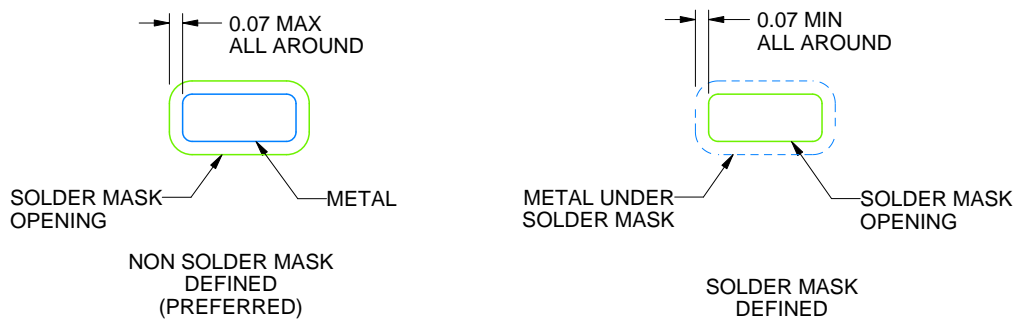

SOLDER MASK DETAILS

4222173/B 04/2018

NOTES: (continued)

4. This package is designed to be soldered to a thermal pad on the board. For more information, see Texas Instruments literature number SLUA271 ([www.ti.com/lit/sluea271](http://www.ti.com/lit/sluea271)).
5. Vias are optional depending on application, refer to device data sheet. If some or all are implemented, recommended via locations are shown.



# EXAMPLE STENCIL DESIGN

DRV0006A

WSON - 0.8 mm max height

PLASTIC SMALL OUTLINE - NO LEAD



SOLDER PASTE EXAMPLE  
BASED ON 0.125 mm THICK STENCIL

EXPOSED PAD #7  
88% PRINTED SOLDER COVERAGE BY AREA UNDER PACKAGE  
SCALE:30X

4222173/B 04/2018

NOTES: (continued)

6. Laser cutting apertures with trapezoidal walls and rounded corners may offer better paste release. IPC-7525 may have alternate design recommendations.

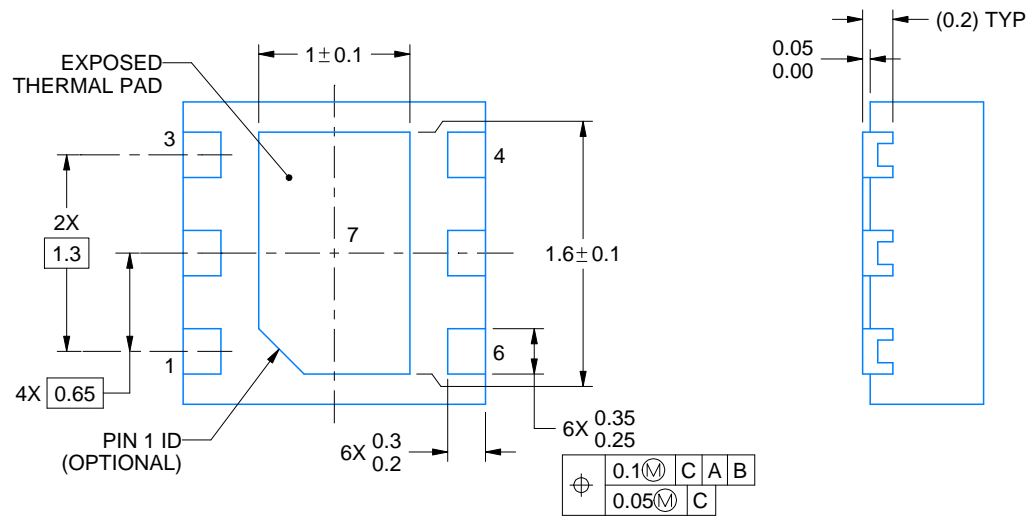
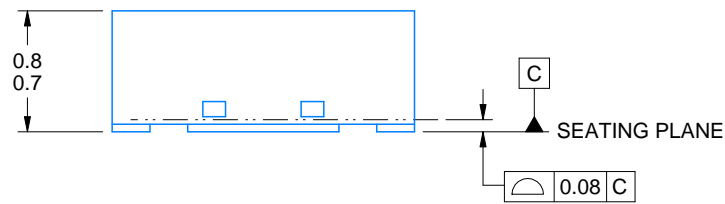

4225563/A 12/2019

NOTES:

1. All linear dimensions are in millimeters. Any dimensions in parenthesis are for reference only. Dimensioning and tolerancing per ASME Y14.5M.
2. This drawing is subject to change without notice.
3. The package thermal pad must be soldered to the printed circuit board for thermal and mechanical performance.



# EXAMPLE STENCIL DESIGN

DRV0006D

WSON - 0.8 mm max height

PLASTIC SMALL OUTLINE - NO LEAD



SOLDER PASTE EXAMPLE  
BASED ON 0.125 mm THICK STENCIL

EXPOSED PAD #7  
88% PRINTED SOLDER COVERAGE BY AREA UNDER PACKAGE  
SCALE:30X

4225563/A 12/2019

NOTES: (continued)

6. Laser cutting apertures with trapezoidal walls and rounded corners may offer better paste release. IPC-7525 may have alternate design recommendations.

DDC (R-PDSO-G5)

PLASTIC SMALL-OUTLINE

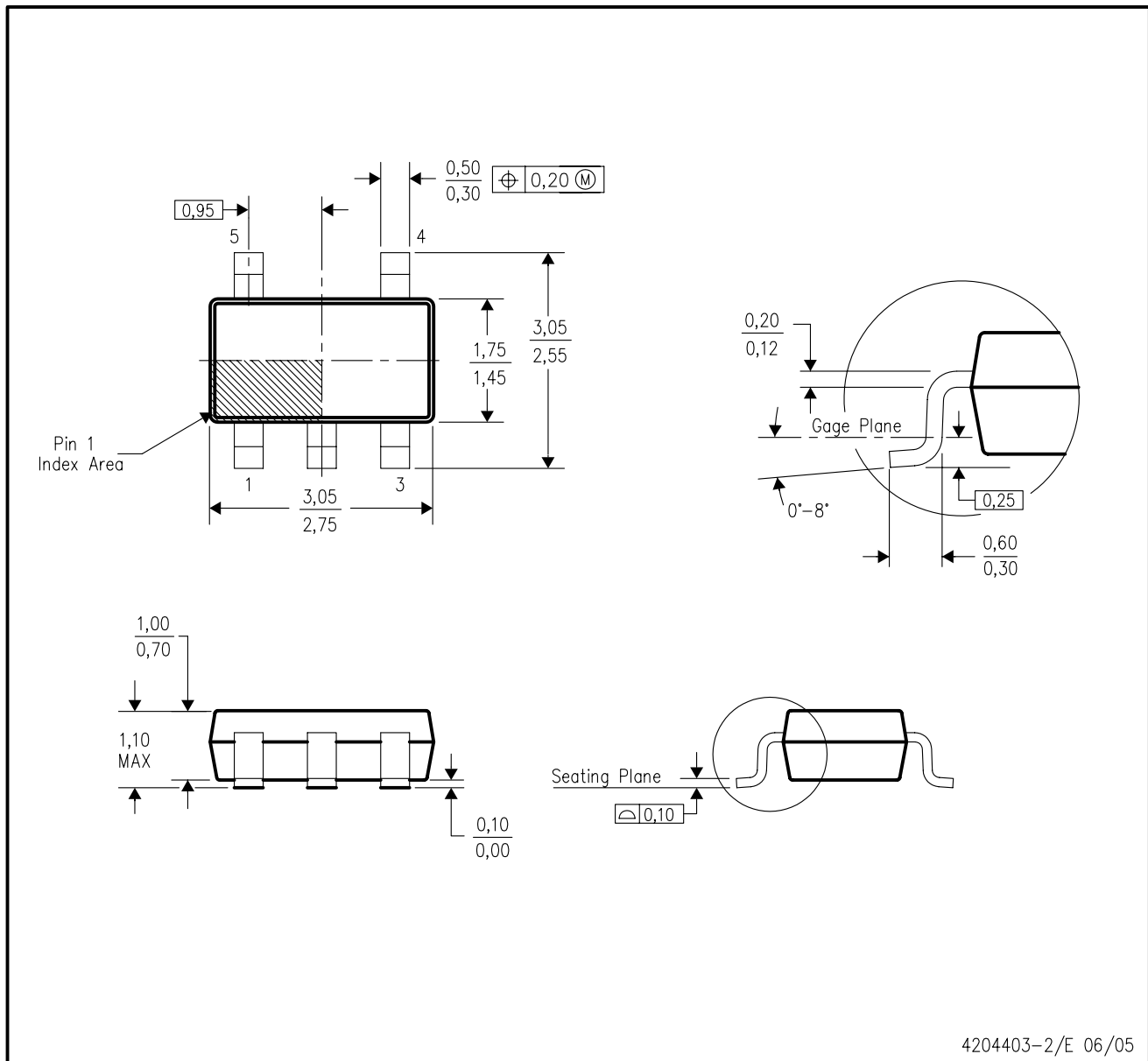

- NOTES:
- All linear dimensions are in millimeters.
  - This drawing is subject to change without notice.
  - Body dimensions do not include mold flash or protrusion.
  - Falls within JEDEC MO-193 variation AB (5 pin).

DDC (R-PDSO-G5)

PLASTIC SMALL OUTLINE

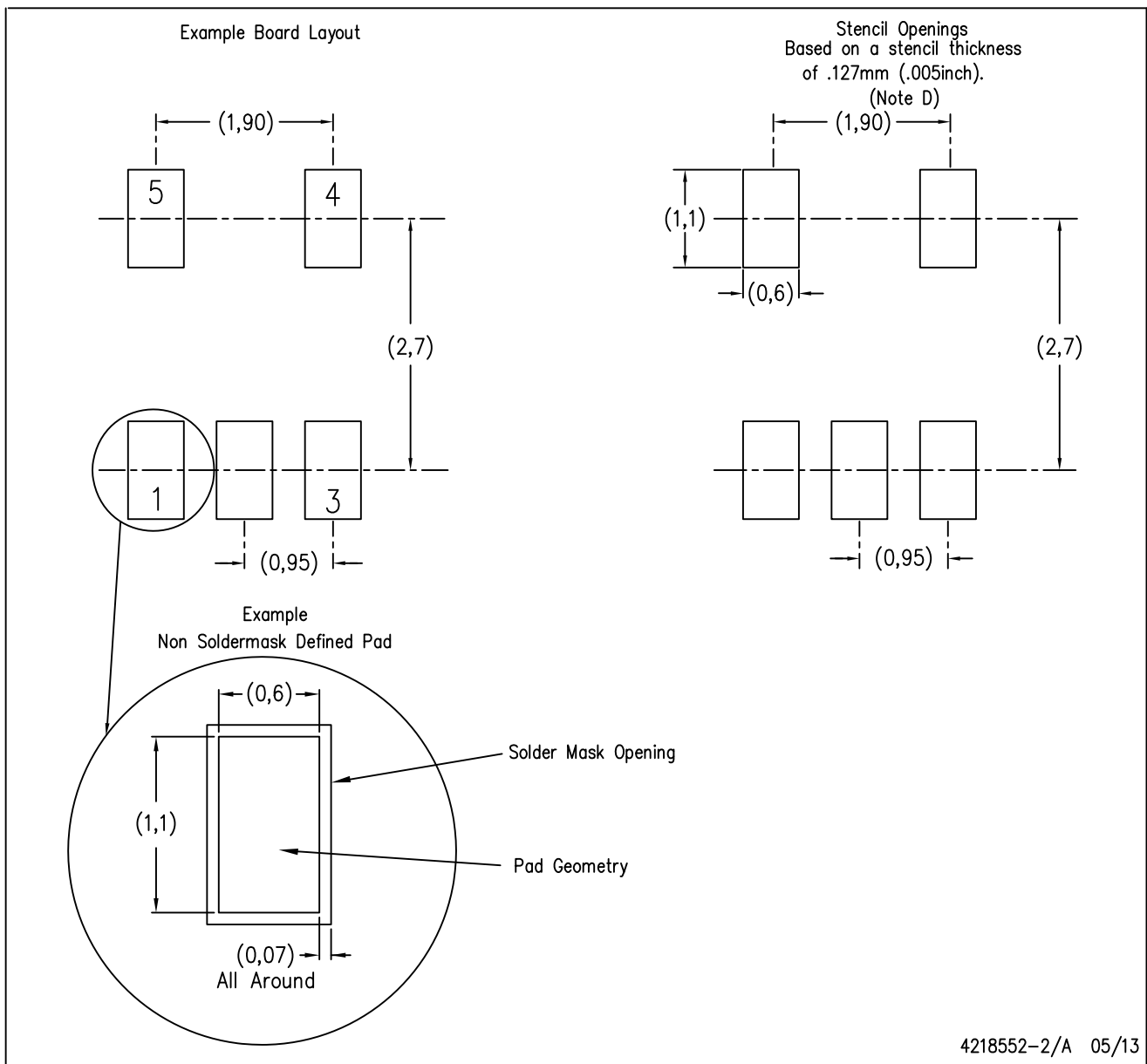

- NOTES:
- A. All linear dimensions are in millimeters.
  - B. This drawing is subject to change without notice.
  - C. Publication IPC-7351 is recommended for alternate designs.
  - D. Laser cutting apertures with trapezoidal walls and also rounding corners will offer better paste release. Customers should contact their board assembly site for stencil design recommendations. Example stencil design based on a 50% volumetric metal load solder paste. Refer to IPC-7525 for other stencil recommendations.

## IMPORTANT NOTICE AND DISCLAIMER

TI PROVIDES TECHNICAL AND RELIABILITY DATA (INCLUDING DATA SHEETS), DESIGN RESOURCES (INCLUDING REFERENCE DESIGNS), APPLICATION OR OTHER DESIGN ADVICE, WEB TOOLS, SAFETY INFORMATION, AND OTHER RESOURCES "AS IS" AND WITH ALL FAULTS, AND DISCLAIMS ALL WARRANTIES, EXPRESS AND IMPLIED, INCLUDING WITHOUT LIMITATION ANY IMPLIED WARRANTIES OF MERCHANTABILITY, FITNESS FOR A PARTICULAR PURPOSE OR NON-INFRINGEMENT OF THIRD PARTY INTELLECTUAL PROPERTY RIGHTS.

These resources are intended for skilled developers designing with TI products. You are solely responsible for (1) selecting the appropriate TI products for your application, (2) designing, validating and testing your application, and (3) ensuring your application meets applicable standards, and any other safety, security, regulatory or other requirements.

These resources are subject to change without notice. TI grants you permission to use these resources only for development of an application that uses the TI products described in the resource. Other reproduction and display of these resources is prohibited. No license is granted to any other TI intellectual property right or to any third party intellectual property right. TI disclaims responsibility for, and you will fully indemnify TI and its representatives against, any claims, damages, costs, losses, and liabilities arising out of your use of these resources.

TI's products are provided subject to [TI's Terms of Sale](#) or other applicable terms available either on [ti.com](http://ti.com) or provided in conjunction with such TI products. TI's provision of these resources does not expand or otherwise alter TI's applicable warranties or warranty disclaimers for TI products.

TI objects to and rejects any additional or different terms you may have proposed.

Mailing Address: Texas Instruments, Post Office Box 655303, Dallas, Texas 75265  
Copyright © 2022, Texas Instruments Incorporated