

TPS786 Ultralow-Noise, High-PSRR, Fast, RF, 1.5-A Low-Dropout Linear Regulators

1 Features

- 1.5-A Low-Dropout Regulator With Enable
- Available in Fixed and Adjustable (1.2 V to 5.5 V) Output Versions
- High PSRR (49 dB at 10 kHz)
- Ultralow Noise (48 μV_{RMS} , TPS78630)
- Fast Start-Up Time (50 μs)
- Stable With a 1- μF Ceramic Capacitor
- Excellent Load and Line Transient Response
- Very Low Dropout Voltage (390 mV at Full Load, TPS78630)
- 3 \times 3 SON PowerPAD™, 6-Pin SOT223 and 5-Pin DDPAK Package

2 Applications

- RF: VCOs, Receivers, ADCs
- Audio
- Bluetooth®, Wireless LAN
- Cellular and Cordless Telephones
- Handheld Organizers, PDAs

3 Description

The TPS786 family of low-dropout (LDO) low-power linear voltage regulators features high power-supply rejection ratio (PSRR), ultralow noise, fast start-up, and excellent line and load transient responses in small outline, SOT223-6 and DDPAK-5 packages. Each device in the family is stable, with a small 1- μF ceramic capacitor on the output. The family uses an advanced, proprietary BiCMOS fabrication process to yield extremely low dropout voltages (for example, 390 mV at 1.5 A). Each device achieves fast start-up times (approximately 50 μs with a 0.001- μF bypass capacitor) while consuming very low quiescent current (265 μA , typical). Moreover, when the device is placed in standby mode, the supply current is reduced to less than 1 μA . The TPS78630 exhibits approximately 48 μV_{RMS} of output voltage at 3-V output noise with a 0.1- μF bypass capacitor. Applications with analog components that are noise sensitive, such as portable RF electronics, benefit from the high PSRR, low noise features, and the fast response time.

Device Information⁽¹⁾

| PART NUMBER | PACKAGE | BODY SIZE (NOM) |
|-------------|-------------|---------------------------|
| TPS786 | TO-263 (5) | 10.16 mm \times 8.42 mm |
| | SOT-223 (6) | 6.50 mm \times 3.50 mm |
| | SON (8) | 3.00 mm \times 3.00 mm |

(1) For all available packages, see the orderable addendum at the end of the data sheet.

Ripple Rejection vs Frequency

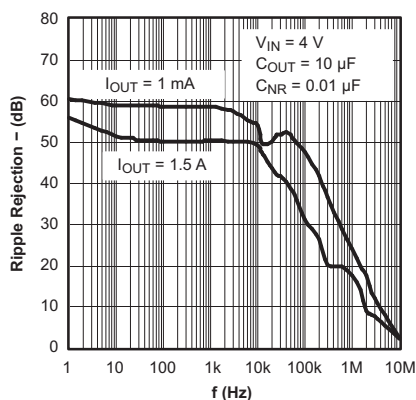

Output Spectral Noise Density vs Frequency

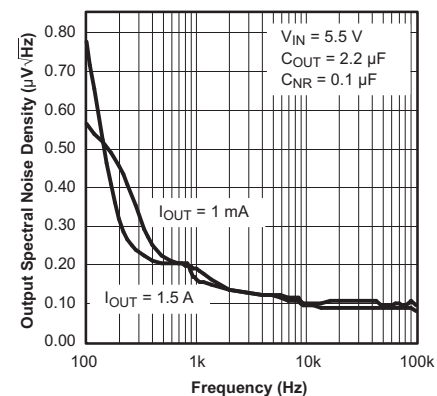

Table of Contents

| | | | |
|--|-----------|--|-----------|
| 1 Features | 1 | 8 Application and Implementation | 13 |
| 2 Applications | 1 | 8.1 Application Information..... | 13 |
| 3 Description | 1 | 8.2 Typical Application | 14 |
| 4 Revision History | 2 | 9 Power Supply Recommendations | 16 |
| 5 Pin Configuration and Functions | 3 | 10 Layout | 16 |
| 6 Specifications | 4 | 10.1 Layout Guidelines | 16 |
| 6.1 Absolute Maximum Ratings | 4 | 10.2 Layout Examples..... | 16 |
| 6.2 ESD Ratings..... | 4 | 10.3 Regulator Mounting..... | 17 |
| 6.3 Recommended Operating Conditions..... | 4 | 10.4 Power Dissipation | 17 |
| 6.4 Thermal Information | 5 | 11 Device and Documentation Support | 21 |
| 6.5 Electrical Characteristics..... | 6 | 11.1 Device Support..... | 21 |
| 6.6 Typical Characteristics | 7 | 11.2 Documentation Support | 21 |
| 7 Detailed Description | 11 | 11.3 Community Resources..... | 21 |
| 7.1 Overview | 11 | 11.4 Trademarks | 21 |
| 7.2 Functional Block Diagrams | 11 | 11.5 Electrostatic Discharge Caution..... | 21 |
| 7.3 Feature Description..... | 12 | 11.6 Glossary | 22 |
| 7.4 Device Functional Modes..... | 12 | 12 Mechanical, Packaging, and Orderable Information | 22 |

4 Revision History

NOTE: Page numbers for previous revisions may differ from page numbers in the current version.

| Changes from Revision L (October 2010) to Revision M | Page |
|--|-------------|
| • Added <i>ESD Ratings</i> table, <i>Feature Description</i> section, <i>Device Functional Modes</i> , <i>Application and Implementation</i> section, <i>Power Supply Recommendations</i> section, <i>Layout</i> section, <i>Device and Documentation Support</i> section, and <i>Mechanical, Packaging, and Orderable Information</i> section | 1 |
| • Updated <i>Thermal Information</i> | 5 |

| Changes from Revision K (August, 2010) to Revision L | Page |
|---|-------------|
| • Corrected typo in Figure 34 | 20 |

| Changes from Revision J (May, 2009) to Revision K | Page |
|---|-------------|
| • Replaced the <i>Dissipation Ratings</i> table with the <i>Thermal Information Table</i> | 5 |
| • Revised section | 17 |

5 Pin Configuration and Functions

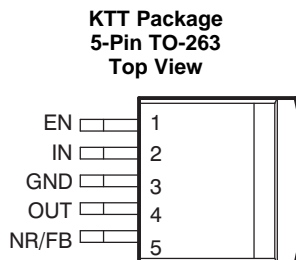
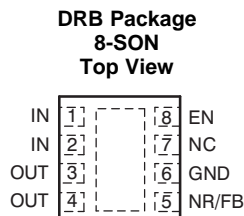
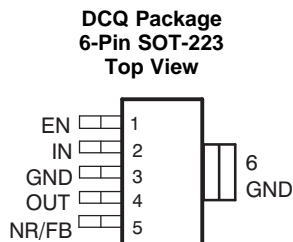

Pin Functions

| NAME | PIN | | | I/O | DESCRIPTION |
|------|---------|--------|------|-----|---|
| | SOT-223 | TO-263 | SON | | |
| NR | 5 | 5 | 5 | — | Noise-reduction pin for fixed versions only. An external bypass capacitor, connected to this terminal, in conjunction with an internal resistor, creates a low-pass filter to further reduce regulator noise. |
| EN | 1 | 1 | 8 | I | The EN terminal is an input that enables or shuts down the device. When EN is a logic high, the device is enabled. When the device is a logic low, the device is in shutdown mode. |
| FB | 5 | 5 | 5 | I | Feedback input voltage for the adjustable device. |
| GND | 3, 6 | 3, TAB | 6 | — | Regulator ground |
| IN | 2 | 2 | 1, 2 | I | Input supply |
| OUT | 4 | 4 | 3, 4 | O | Regulator output |

6 Specifications

6.1 Absolute Maximum Ratings

over operating free-air temperature range (unless otherwise noted)⁽¹⁾

| | MIN | MAX | UNIT |
|------------------------------------|---|----------------|------|
| V_{IN} | –0.3 | 6 | V |
| V_{EN} | –0.3 | $V_{IN} + 0.3$ | V |
| V_{OUT} | | 6 | V |
| Peak output current | Internally limited | | |
| Continuous total power dissipation | See Thermal Information | | |
| Junction temperature, T_J | –40 | 150 | °C |
| Storage temperature, T_{stg} | –65 | 150 | °C |

- (1) Stresses beyond those listed under *Absolute Maximum Ratings* may cause permanent damage to the device. These are stress ratings only, which do not imply functional operation of the device at these or any other conditions beyond those indicated under *Recommended Operating Conditions*. Exposure to absolute-maximum-rated conditions for extended periods may affect device reliability.

6.2 ESD Ratings

| | | VALUE | UNIT |
|-------------------------------------|--|-------|------|
| $V_{(ESD)}$ Electrostatic discharge | Human body model (HBM), per ANSI/ESDA/JEDEC JS-001, all pins ⁽¹⁾ | ±2000 | V |
| | Charged device model (CDM), per JEDEC specification JESD22-C101, all pins ⁽²⁾ | ±500 | |

- (1) JEDEC document JEP155 states that 500-V HBM allows safe manufacturing with a standard ESD control process.

- (2) JEDEC document JEP157 states that 250-V CDM allows safe manufacturing with a standard ESD control process.

6.3 Recommended Operating Conditions

over operating junction temperature range (unless otherwise noted)

| | MIN | NOM | MAX | UNIT |
|--------------------------------------|-----|-----|-----|------|
| V_{IN} Input supply voltage | 2.7 | | 5.5 | V |
| I_{OUT} Output current | 0 | | 1.5 | A |
| T_J Operating junction temperature | –40 | | 125 | °C |

6.4 Thermal Information

| THERMAL METRIC ⁽¹⁾⁽²⁾ | | TPS786 ⁽³⁾ | | | UNIT |
|----------------------------------|--|-----------------------|---------------|--------------|------|
| | | DRB (SON) | DCQ (S0T-223) | KTT (TO-263) | |
| | | 8 PINS | 6 PINS | 5 PINS | |
| R _{θJA} | Junction-to-ambient thermal resistance | 41.1 | 54.2 | 40.7 | °C/W |
| R _{θJC(top)} | Junction-to-case (top) thermal resistance | 49.1 | 33.3 | 43.1 | °C/W |
| R _{θJB} | Junction-to-board thermal resistance | 16.6 | 8.9 | 21.5 | °C/W |
| ψ _{JT} | Junction-to-top characterization parameter | 0.7 | 2.6 | 9.4 | °C/W |
| ψ _{JB} | Junction-to-board characterization parameter | 16.8 | 8.8 | 20 | °C/W |
| R _{θJC(bot)} | Junction-to-case (bottom) thermal resistance | 5.2 | N/A | 2.1 | °C/W |

- (1) For more information about traditional and new thermal metrics, see the *Semiconductor and IC Package Thermal Metrics* application report, [SPRA953](#).
- (2) For thermal estimates of this device based on PCB copper area, see the [TI PCB Thermal Calculator](#).
- (3) Thermal data for the DRB, DCQ, and DRV packages are derived by thermal simulations based on JEDEC-standard methodology as specified in the JESD51 series. The following assumptions are used in the simulations:
- DRB: The exposed pad is connected to the PCB ground layer through a 2x2 thermal via array.
 - DCQ: The exposed pad is connected to the PCB ground layer through a 3x2 thermal via array.
 - KTT: The exposed pad is connected to the PCB ground layer through a 5x4 thermal via array.
- DRB: The top and bottom copper layers are assumed to have a 20% thermal conductivity of copper representing a 20% copper coverage.
 - DCQ: Each of top and bottom copper layers has a dedicated pattern for 20% copper coverage.
 - KTT: The top and bottom copper layers are assumed to have a 20% thermal conductivity of copper representing a 20% copper coverage.
- (c) These data were generated with only a single device at the center of a JEDEC high-K (2s2p) board with 3 inches x 3 inches copper area. To understand the effects of the copper area on thermal performance, see the [Power Dissipation](#) and [Estimating Junction Temperature](#) sections of this data sheet.

6.5 Electrical Characteristics

Over recommended operating temperature range ($T_J = -40^{\circ}\text{C}$ to 125°C), $V_{EN} = V_{IN}$, $V_{IN} = V_{OUT(nom)} + 1\text{ V}^{(1)}$, $I_{OUT} = 1\text{ mA}$, $C_{OUT} = 10\text{ }\mu\text{F}$, and $C_{NR} = 0.01\text{ }\mu\text{F}$, unless otherwise noted. Typical values are at 25°C .

| PARAMETER | | TEST CONDITIONS | MIN | TYP | MAX | UNIT | |
|--|----------------------|--|--|-----------------|----------------|---------------------|---|
| Input voltage, $V_{IN}^{(1)}$ | | | 2.7 | | 5.5 | V | |
| Internal reference, V_{FB} (TPS78601) | | | 1.200 | 1.225 | 1.250 | V | |
| Continuous output current I_{OUT} | | | 0 | | 1.5 | A | |
| Output voltage | Output voltage range | TPS78601 | 1.225 | | $5.5 - V_{DO}$ | V | |
| | Accuracy | TPS78601 ⁽²⁾ | $0\text{ }\mu\text{A} \leq I_{OUT} \leq 1.5\text{ A}$, $V_{OUT} + 1\text{ V} \leq V_{IN} \leq 5.5\text{ V}^{(1)}$ | $(0.98)V_{OUT}$ | V_{OUT} | $(1.02)V_{OUT}$ | V |
| | | Fixed $V_{OUT} < 5\text{ V}$ | $0\text{ }\mu\text{A} \leq I_{OUT} \leq 1.5\text{ A}$, $V_{OUT} + 1\text{ V} \leq V_{IN} \leq 5.5\text{ V}^{(1)}$ | -2% | | 2% | |
| | | Fixed $V_{OUT} = 5\text{ V}$ | $0\text{ }\mu\text{A} \leq I_{OUT} \leq 1.5\text{ A}$, $V_{OUT} + 1\text{ V} \leq V_{IN} \leq 5.5\text{ V}^{(1)}$ | -3% | | 3% | |
| Output voltage line regulation ($\Delta V_{OUT}\%/V_{IN}^{(1)}$) | | $V_{OUT} + 1\text{ V} \leq V_{IN} \leq 5.5\text{ V}$ | | 5 | 12 | %/V | |
| Load regulation ($\Delta V_{OUT}\%/V_{OUT}$) | | $0\text{ }\mu\text{A} \leq I_{OUT} \leq 1.5\text{ A}$ | | 7 | | mV | |
| Dropout voltage ⁽³⁾ $V_{IN} = V_{OUT(nom)} - 0.1\text{ V}$ | | TPS78628 | $I_{OUT} = 1.5\text{ A}$ | 410 | 580 | mV | |
| | | TPS78630 | $I_{OUT} = 1.5\text{ A}$ | 390 | 550 | | |
| | | TPS78633 | $I_{OUT} = 1.5\text{ A}$ | 340 | 510 | | |
| | | TPS78650 | $I_{OUT} = 1.5\text{ A}$ | 310 | 470 | | |
| Output current limit | | $V_{OUT} = 0\text{ V}$ | 2.4 | | 4.2 | A | |
| Ground pin current | | $0\text{ }\mu\text{A} \leq I_{OUT} \leq 1.5\text{ A}$ | | 260 | 385 | μA | |
| Shutdown current ⁽⁴⁾ | | $V_{EN} = 0\text{ V}$, $2.7\text{ V} \leq V_{IN} \leq 5.5\text{ V}$ | | 0.07 | 1 | μA | |
| FB pin current | | $V_{FB} = 1.225\text{ V}$ | | | 1 | μA | |
| Power-supply ripple rejection | TPS78630 | $f = 100\text{ Hz}$, $I_{OUT} = 10\text{ mA}$ | | 59 | | dB | |
| | | $f = 100\text{ Hz}$, $I_{OUT} = 1.5\text{ A}$ | | 52 | | | |
| | | $f = 10\text{ kHz}$, $I_{OUT} = 1.5\text{ A}$ | | 49 | | | |
| | | $f = 100\text{ kHz}$, $I_{OUT} = 1.5\text{ A}$ | | 32 | | | |
| Output noise voltage (TPS78630) | | $BW = 100\text{ Hz to }100\text{ kHz}$, $I_{OUT} = 1.5\text{ A}$ | $C_{NR} = 0.001\text{ }\mu\text{F}$ | 66 | | μV_{RMS} | |
| | | | $C_{NR} = 0.0047\text{ }\mu\text{F}$ | 51 | | | |
| | | | $C_{NR} = 0.01\text{ }\mu\text{F}$ | 49 | | | |
| | | | $C_{NR} = 0.1\text{ }\mu\text{F}$ | 48 | | | |
| Time, start-up (TPS78630) | | $R_L = 2\text{ }\Omega$, $C_{OUT} = 1\text{ }\mu\text{F}$ | $C_{NR} = 0.001\text{ }\mu\text{F}$ | 50 | | μs | |
| | | | $C_{NR} = 0.0047\text{ }\mu\text{F}$ | 75 | | | |
| | | | $C_{NR} = 0.01\text{ }\mu\text{F}$ | 110 | | | |
| High-level enable input voltage | | $2.7\text{ V} \leq V_{IN} \leq 5.5\text{ V}$ | 1.7 | | V_{IN} | V | |
| Low-level enable input voltage | | $2.7\text{ V} \leq V_{IN} \leq 5.5\text{ V}$ | 0 | | 0.7 | V | |
| EN pin current | | $V_{EN} = 0$ | -1 | | 1 | μA | |
| UVLO threshold | | V_{CC} rising | 2.25 | | 2.65 | V | |
| UVLO hysteresis | | | | 100 | | mV | |

(1) Minimum $V_{IN} = V_{OUT} + V_{DO}$ or 2.7 V , whichever is greater. The TPS78650 is tested at $V_{IN} = 5.5\text{ V}$.

(2) Tolerance of external resistors not included in this specification.

(3) Dropout is not measured for TPS78618 or TPS78625 because minimum $V_{IN} = 2.7\text{ V}$.

(4) For adjustable version, this applies only after V_{IN} is applied; then V_{EN} transitions high to low.

6.6 Typical Characteristics

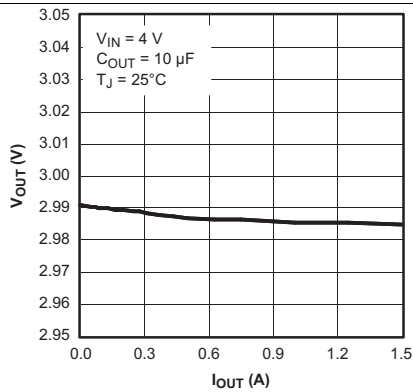

Figure 1. TPS78630 Output Voltage vs Output Current

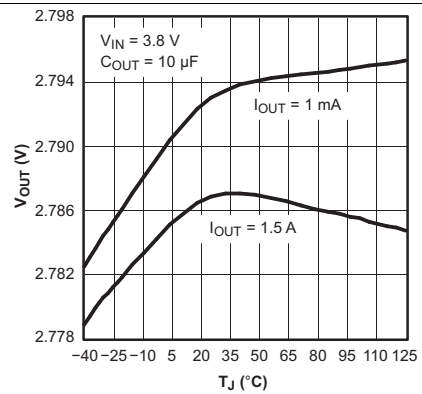

Figure 2. TPS78628 Output Voltage vs Junction Temperature

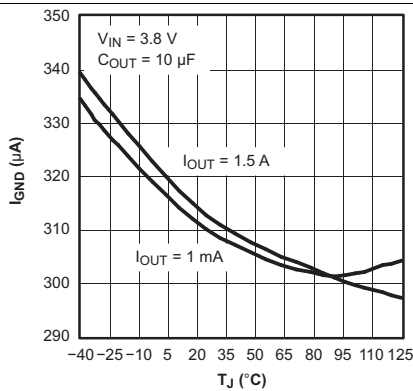

Figure 3. TPS78628 Ground Current vs Junction Temperature

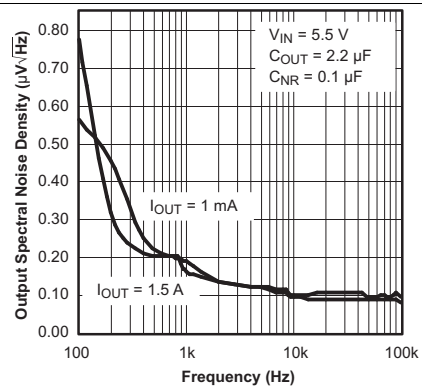

Figure 4. TPS78630 Output Spectral Noise Density vs Frequency

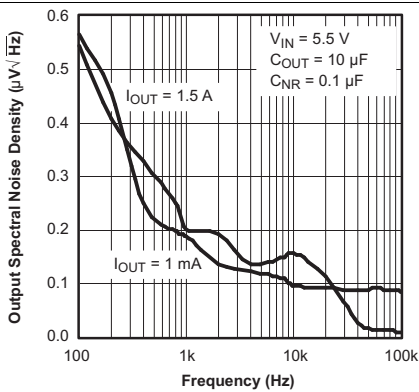

Figure 5. TPS78630 Output Spectral Noise Density vs Frequency

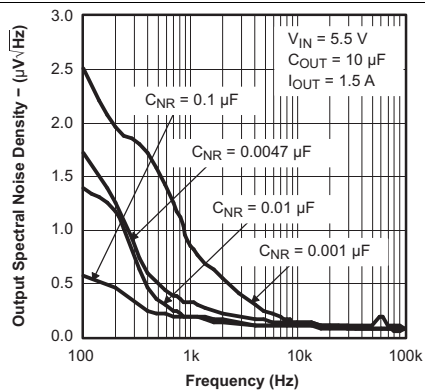

Figure 6. TPS78630 Output Spectral Noise Density vs Frequency

Typical Characteristics (continued)

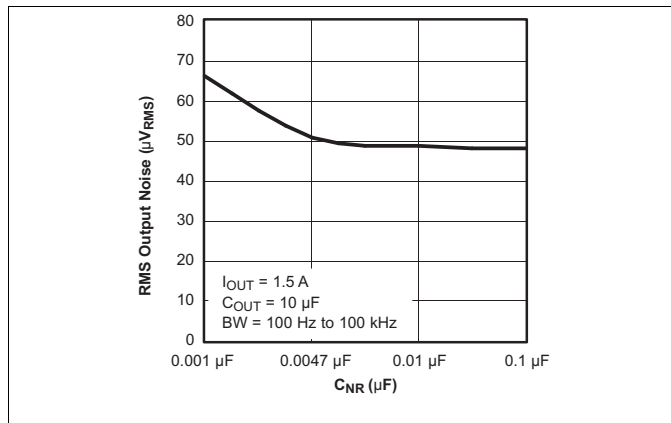

Figure 7. TPS78630 Root Mean Squared Output Noise vs Bypass Capacitance

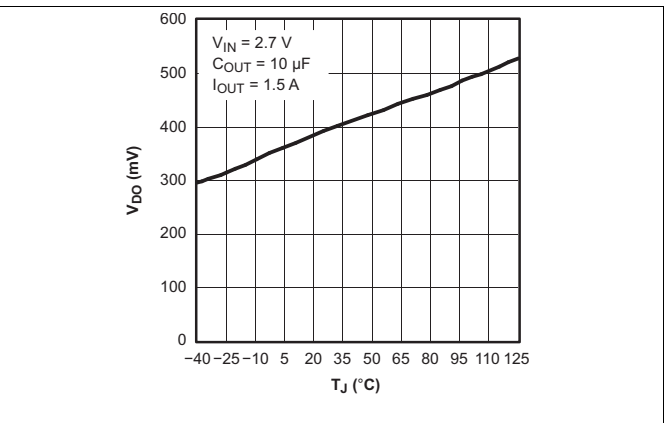

Figure 8. TPS78628 Dropout Voltage vs Junction Temperature

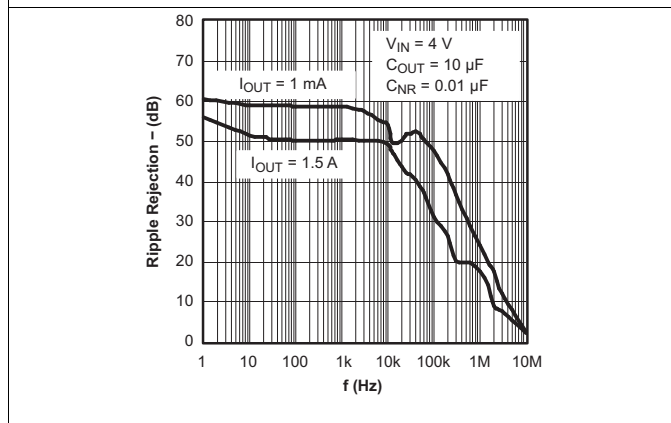

Figure 9. TPS78630 Ripple Rejection vs Frequency

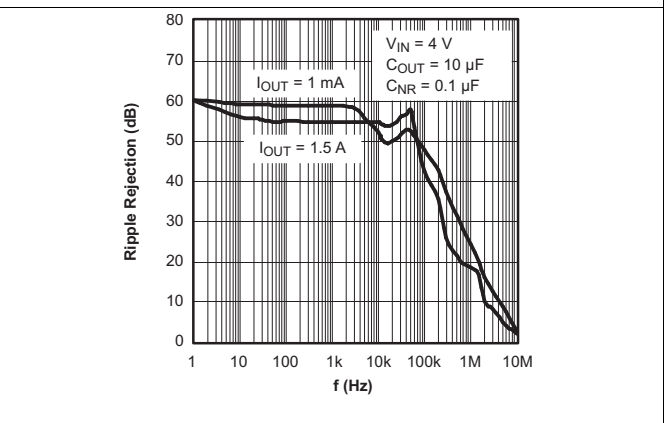

Figure 10. TPS78630 Ripple Rejection vs Frequency

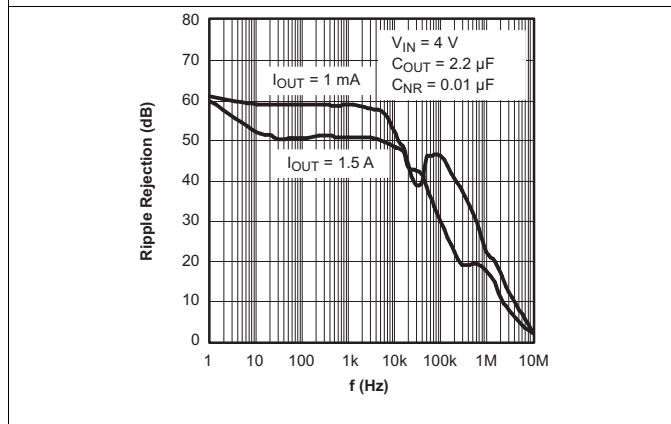

Figure 11. TPS78630 Ripple Rejection vs Frequency

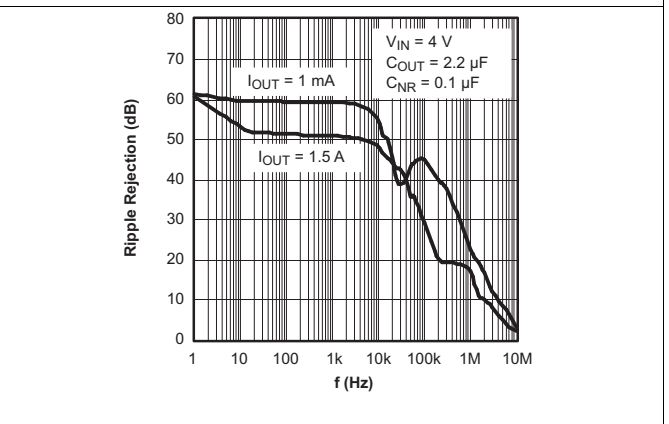

Figure 12. TPS78630 Ripple Rejection vs Frequency

Typical Characteristics (continued)

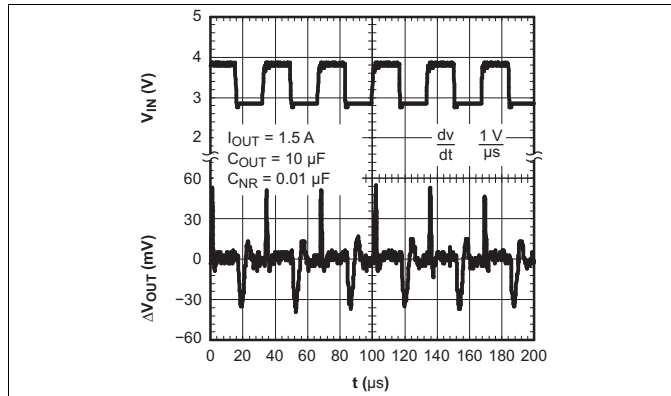

Figure 13. TPS78618 Line Transient Response

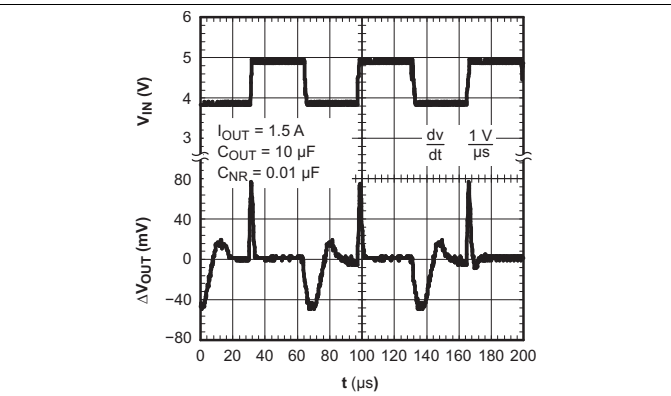

Figure 14. TPS78630 Line Transient Response

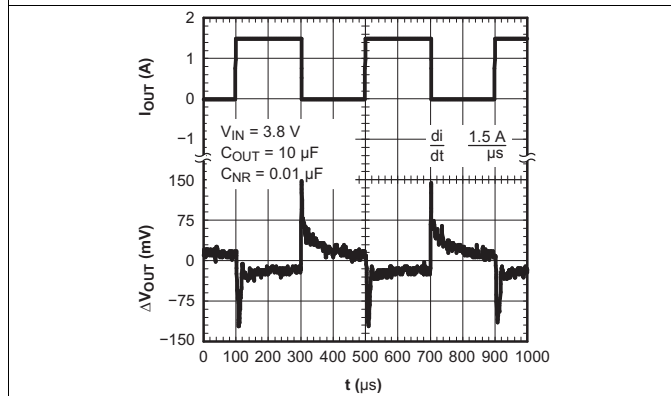

Figure 15. TPS78628 Load Transient Response

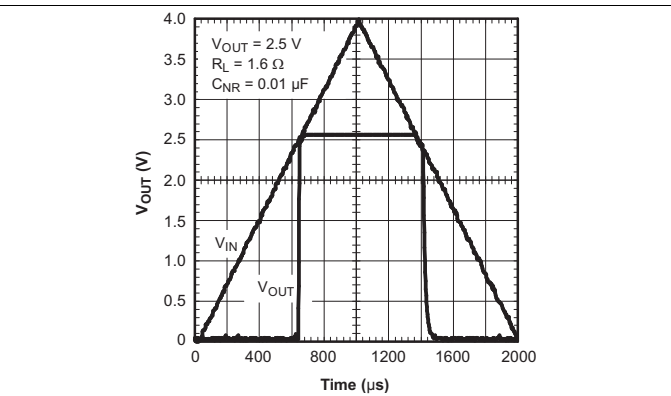

Figure 16. TPS78625 Power Up and Power Down

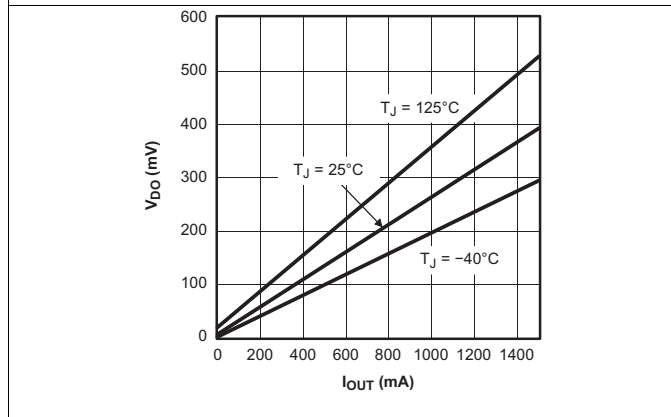

Figure 17. TPS78630 Dropout Voltage vs Output Current

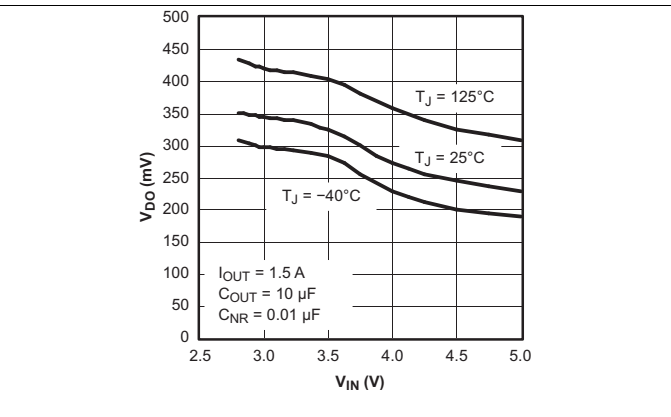

Figure 18. TPS78601 Dropout Voltage vs Input Voltage

Typical Characteristics (continued)

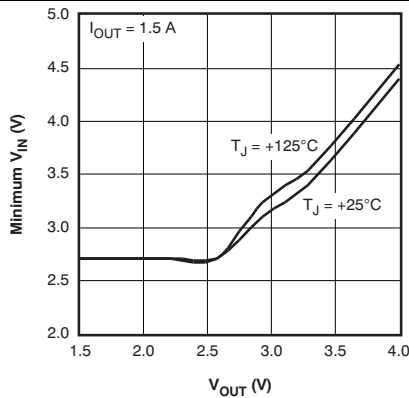

Figure 19. Minimum Required Input Voltage vs Output Voltage

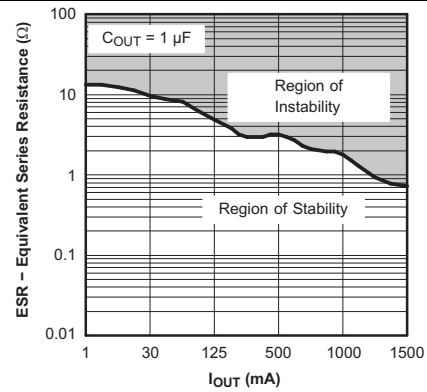

Figure 20. TPS78630 Typical Regions of Stability Equivalent Series Resistance (ESR) vs Output Current

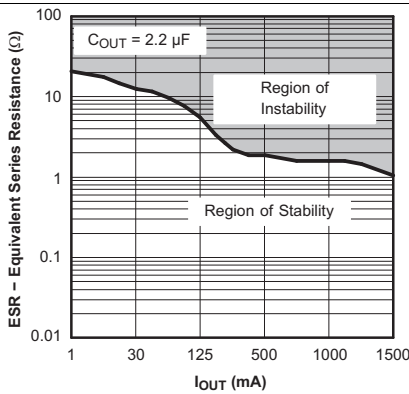

Figure 21. TPS78630 Typical Regions of Stability Equivalent Series Resistance (ESR) vs Output Current

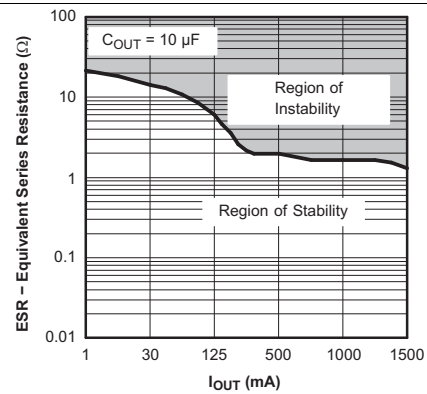

Figure 22. TPS78630 Typical Regions of Stability Equivalent Series Resistance (ESR) vs Output Current

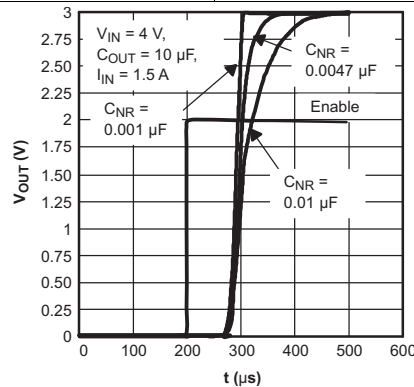

Figure 23. Start-Up

7 Detailed Description

7.1 Overview

The TPS786 family of low-dropout regulators offers low dropout voltages, high PSRR, and low-output noise.

7.2 Functional Block Diagrams

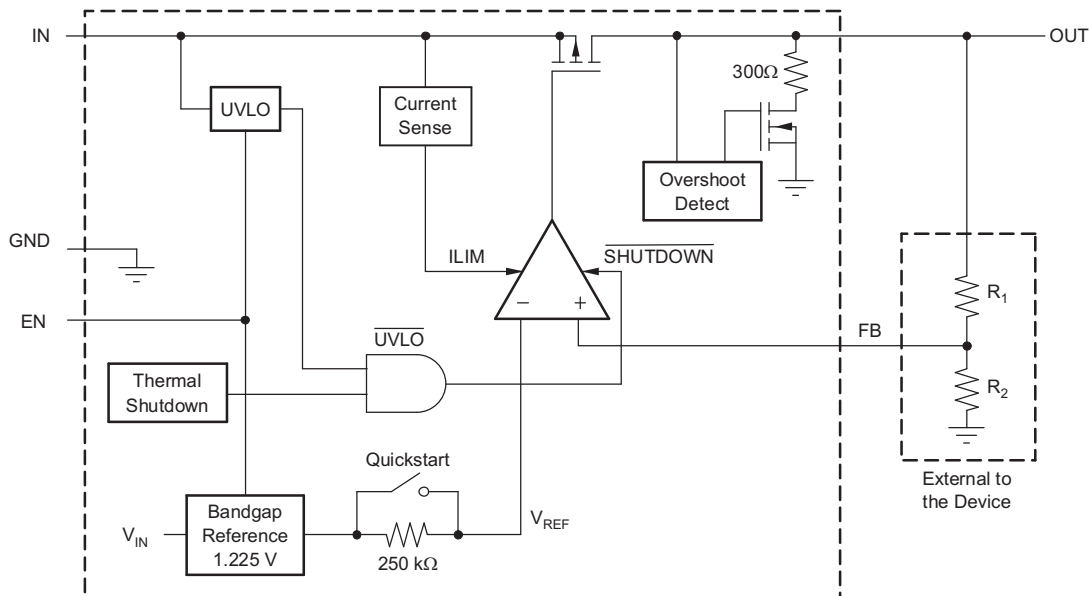

Figure 24. Functional Block Diagram—Adjustable Version

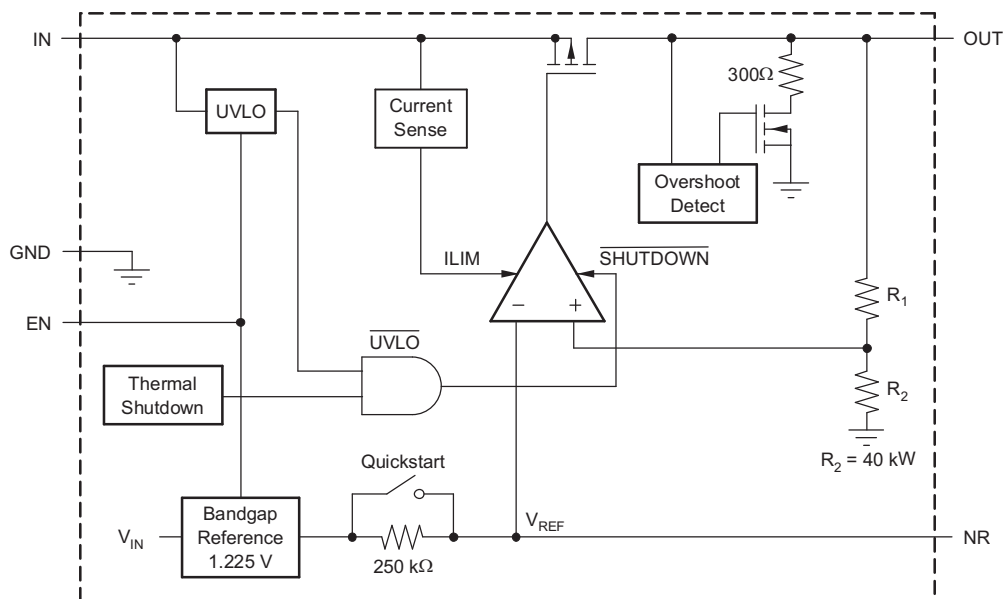

Figure 25. Functional Block Diagram—Fixed Version

7.3 Feature Description

7.3.1 Regulator Protection

The TPS786 PMOS-pass transistor has a built-in back diode that conducts reverse current when the input voltage drops below the output voltage (for example, during power down). Current is conducted from the output to the input and is not internally limited. If extended reverse voltage operation is anticipated, external limiting might be appropriate.

The TPS786 features internal current limiting and thermal protection. During normal operation, the TPS786 limits output current to approximately 2.8 A. When current limiting engages, the output voltage scales back linearly until the overcurrent condition ends. While current limiting is designed to prevent gross device failure, take care not to exceed the power dissipation ratings of the package. If the temperature of the device exceeds approximately 165°C, thermal-protection circuitry shuts it down. Once the device has cooled down to below approximately 140°C, regulator operation resumes.

7.4 Device Functional Modes

Driving EN over 1.7 V turns on the regulator. Driving EN below 0.7 V puts the regulator into shutdown mode, thus reducing the operating current to 70 nA, nominal.

8 Application and Implementation

NOTE

Information in the following applications sections is not part of the TI component specification, and TI does not warrant its accuracy or completeness. TI's customers are responsible for determining suitability of components for their purposes. Customers should validate and test their design implementation to confirm system functionality.

8.1 Application Information

The TPS786 family of low-dropout (LDO) regulators has been optimized for use in noise-sensitive equipment. The device features extremely low dropout voltages, high PSRR, ultralow-output noise, low quiescent current (265 μ A, typically), and enable input to reduce supply currents to less than 1 μ A when the regulator is turned off.

8.1.1 Programming the TPS78601 Adjustable LDO Regulator

The output voltage of the TPS78601 adjustable regulator is programmed using an external resistor divider as shown in [Figure 26](#). The output voltage is calculated using [Equation 1](#):

$$V_{OUT} = V_{REF} \times \left(1 + \frac{R_1}{R_2} \right)$$

where

- $V_{REF} = 1.2246$ V typical (the internal reference voltage) (1)

Resistors R_1 and R_2 should be chosen for approximately 40- μ A divider current. Lower value resistors can be used for improved noise performance, but the device wastes more power. Higher values should be avoided, as leakage current at FB increases the output voltage error.

The recommended design procedure is to choose $R_2 = 30.1$ k Ω to set the divider current at 40 μ A, $C_1 = 15$ pF for stability, and then calculate R_1 using [Equation 2](#).

$$R_1 = \left(\frac{V_{OUT}}{V_{REF}} - 1 \right) \times R_2$$
 (2)

To improve the stability of the adjustable version, TI suggests placing a small compensation capacitor between OUT and FB.

The approximate value of this capacitor can be calculated using [Equation 3](#):

$$C_1 = \frac{(3 \times 10^{-7}) \times (R_1 + R_2)}{(R_1 \times R_2)}$$
 (3)

The suggested value of this capacitor for several resistor ratios is shown in [Figure 26](#). If this capacitor is not used (such as in a unity-gain configuration), then the minimum recommended output capacitor is 2.2 μ F instead of 1 μ F.

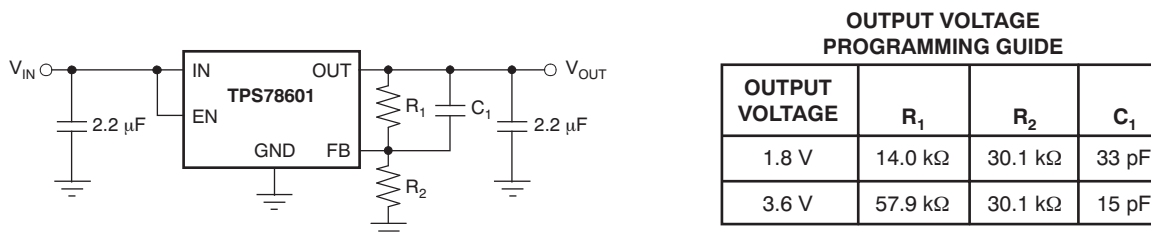

Figure 26. TPS78601 Adjustable LDO Regulator Programming

8.2 Typical Application

A typical application circuit is shown in [Figure 27](#).

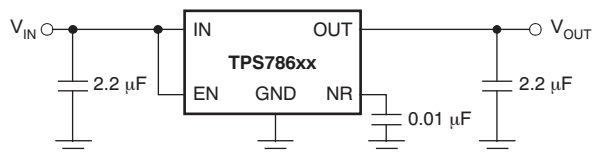

Figure 27. Typical Application Circuit

8.2.1 Design Requirements

[Table 1](#) shows the design parameters for this application.

Table 1. Design Parameters

| DESIGN PARAMETERS | EXAMPLE VALUE |
|----------------------|-----------------------------------|
| V_{IN} (from DCDC) | Minimum = 4 V Maximum = 5.5 V |
| V_{OUT} | 3 V \pm -1% |
| I_{OUT} | Minimum = 1 mA Maximum = 1.5 A |
| PSRR at 1K | >50 db |
| Noise at 1K | <20 μ V/ $\sqrt{\text{Hz}}$ |

8.2.2 Detailed Design Procedure

Select TPS78630 to satisfy the V_{OUT} requirements. The fixed version of the device is chosen to save board space and reduce BOM cost.

Use a 2.2- μ F capacitor on both the input and output to satisfy the capacitor requirements. Select a 0.1- μ F NR capacitor to satisfy the noise requirement.

8.2.2.1 External Capacitor Requirements

A 2.2- μ F or larger ceramic input bypass capacitor, connected between IN and GND and located close to the TPS786, is required for stability and improves transient response, noise rejection, and ripple rejection. A higher-value input capacitor may be necessary if large, fast-rise-time load transients are anticipated and the device is located several inches from the power source.

Like most low-dropout regulators, the TPS786 requires an output capacitor connected between OUT and GND to stabilize the internal control loop. The minimum recommended capacitor is 1 μ F. Any 1- μ F or larger ceramic capacitor is suitable.

The internal voltage reference is a key source of noise in an LDO regulator. The TPS786 has an NR pin that is connected to the voltage reference through a 250-k Ω internal resistor. The 250-k Ω internal resistor, in conjunction with an external bypass capacitor connected to the NR pin, creates a low pass filter to reduce the voltage reference noise and, therefore, the noise at the regulator output. For the regulator to operate properly, the current flow out of the NR pin must be at a minimum, because any leakage current creates an IR drop across the internal resistor, thus creating an output error. Therefore, the bypass capacitor must have minimal leakage current. The bypass capacitor should be no more than 0.1- μ F to ensure that it is fully charged during the quickstart time provided by the internal switch shown in [Functional Block Diagrams](#).

For example, the TPS78630 exhibits only 48 μ V_{RMS} of output voltage noise using a 0.1- μ F ceramic bypass capacitor and a 10- μ F ceramic output capacitor. The output starts up slower as the bypass capacitance increases due to the RC time constant at the bypass pin that is created by the internal 250-k Ω resistor and external capacitor.

8.2.3 Application Curves

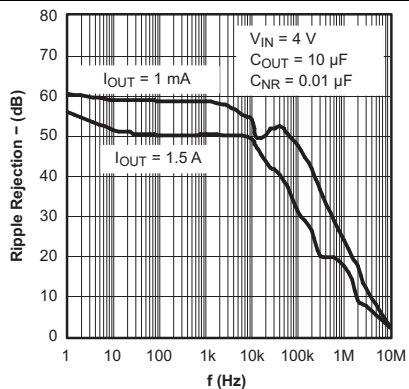

Figure 28. Ripple Rejection vs Frequency

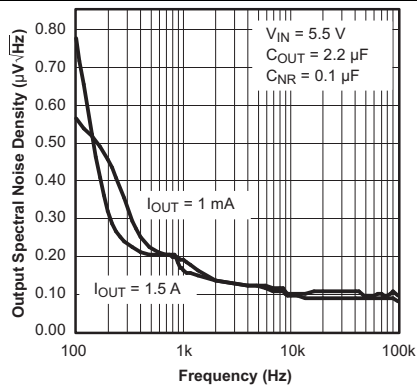

Figure 29. Output Spectral Noise Density vs Frequency

9 Power Supply Recommendations

These devices are designed to operate from an input voltage supply range from 2.7 V to 5.5 V. The input voltage range provides adequate headroom for the device to have a regulated output. This input supply is well-regulated and stable. If the input supply is noisy, additional input capacitors with low ESR can help improve the output noise performance.

10 Layout

10.1 Layout Guidelines

To improve AC measurements like PSRR, output noise, and transient response, TI recommends designing the board with separate ground planes for V_{IN} and V_{OUT} , with each ground plane connected only at the ground pin of the device. In addition, the ground connection for the bypass capacitor should connect directly to the ground pin of the device.

10.2 Layout Examples

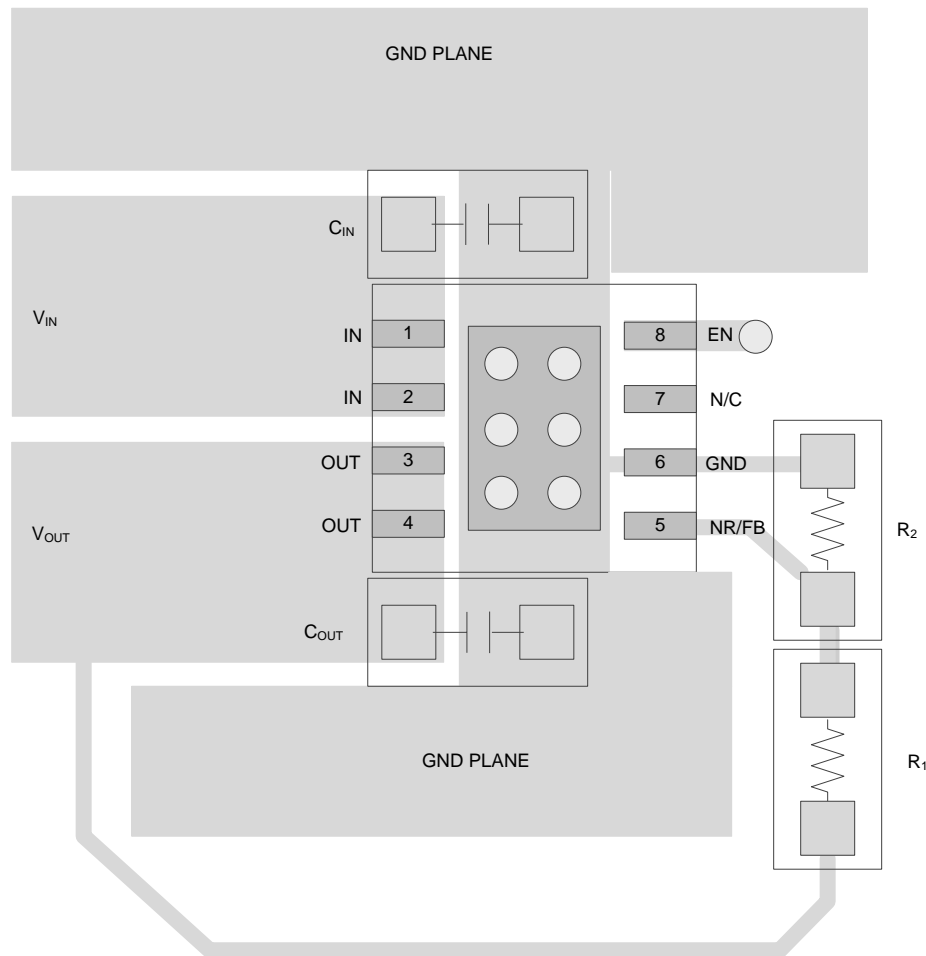

Figure 30. Recommended Layout – Adjustable-Voltage Version

Layout Examples (continued)

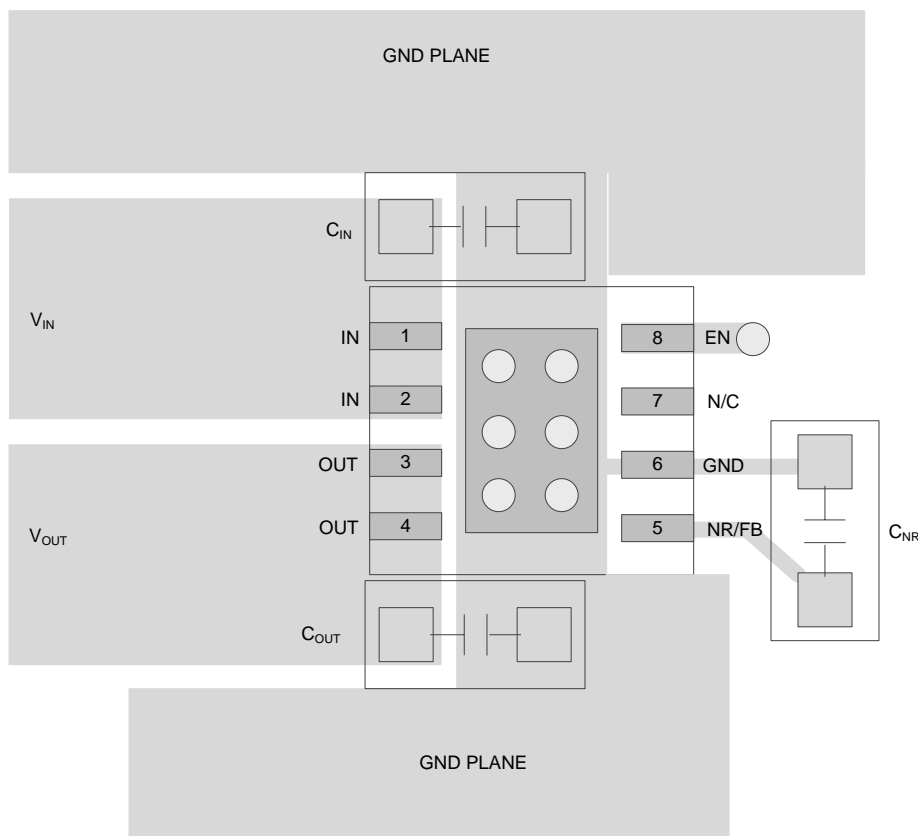

Figure 31. Recommended Layout – Fixed-Voltage Version

10.3 Regulator Mounting

The tab of the SOT223-6 package is electrically connected to ground. For best thermal performance, the tab of the surface-mount version should be soldered directly to a circuit-board copper area. Increasing the copper area improves heat dissipation.

Solder pad footprint recommendations for the devices are presented in Application Report [SBFA015](#), *Solder Pad Recommendations for Surface-Mount Devices*, available from the TI website at [www.ti.com](#).

10.4 Power Dissipation

Knowing the device power dissipation and proper sizing of the thermal plane that is connected to the tab or pad is critical to avoiding thermal shutdown and ensuring reliable operation.

Power dissipation of the device depends on input voltage and load conditions and can be calculated using [Equation 4](#):

$$P_D = (V_{IN} - V_{OUT}) \times I_{OUT} \tag{4}$$

Power dissipation can be minimized and greater efficiency can be achieved by using the lowest possible input voltage necessary to achieve the required output voltage regulation.

Power Dissipation (continued)

On the SON (DRB) package, the primary conduction path for heat is through the exposed pad to the printed-circuit-board (PCB). The pad can be connected to ground or be left floating; however, it should be attached to an appropriate amount of copper PCB area to ensure the device does not overheat. On both SOT-223 (DCQ) and DDPAK (KTT) packages, the primary conduction path for heat is through the tab to the PCB. That tab should be connected to ground. The maximum junction-to-ambient thermal resistance depends on the maximum ambient temperature, maximum device junction temperature, and power dissipation of the device and can be calculated using [Equation 5](#):

$$R_{\theta JA} = \frac{(+125^{\circ}\text{C} - T_A)}{P_D} \quad (5)$$

Knowing the maximum $R_{\theta JA}$, the minimum amount of PCB copper area needed for appropriate heatsinking can be estimated using [Figure 32](#).

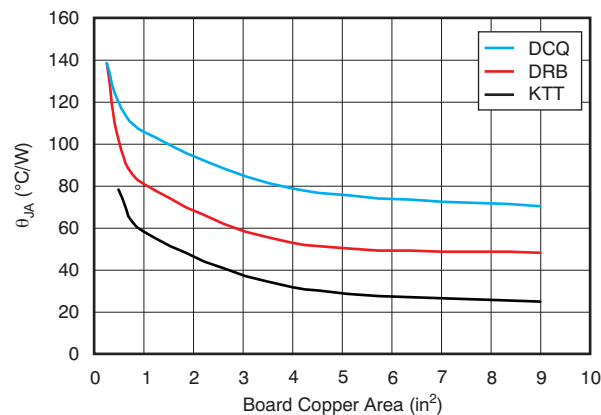

Note: θ_{JA} value at board size of 9in² (that is, 3in x 3in) is a JEDEC standard.

Figure 32. θ_{JA} vs Board Size

[Figure 32](#) shows the variation of θ_{JA} as a function of ground plane copper area in the board. It is intended only as a guideline to demonstrate the effects of heat spreading in the ground plane and should not be used to estimate actual thermal performance in real application environments.

NOTE

When the device is mounted on an application PCB, TI strongly recommends using Ψ_{JT} and Ψ_{JB} , as explained in the section.

10.4.1 Estimating Junction Temperature

Using the thermal metrics Ψ_{JT} and Ψ_{JB} , as shown in the [Thermal Information](#) table, the junction temperature can be estimated with corresponding formulas (given in [Equation 6](#)). For backwards compatibility, an older $\theta_{JC, Top}$ parameter is listed as well.

$$\Psi_{JT}: T_J = T_T + \Psi_{JT} \cdot P_D$$

$$\Psi_{JB}: T_J = T_B + \Psi_{JB} \cdot P_D$$

where

- P_D is the power dissipation shown by [Equation 5](#).
- T_T is the temperature at the center-top of the IC package.
- T_B is the PCB temperature measured 1mm away from the IC package *on the PCB surface* (as [Figure 34](#) shows). (6)

Power Dissipation (continued)

NOTE

Both T_T and T_B can be measured on actual application boards using a thermo-gun (an infrared thermometer).

For more information about measuring T_T and T_B , see the application note [SBVA025, Using New Thermal Metrics](#), available for download at [www.ti.com](#).

By looking at [Figure 33](#), the new thermal metrics (Ψ_{JT} and Ψ_{JB}) have very little dependency on board size. That is, using Ψ_{JT} or Ψ_{JB} with [Equation 6](#) is a good way to estimate T_J by simply measuring T_T or T_B , regardless of the application board size.

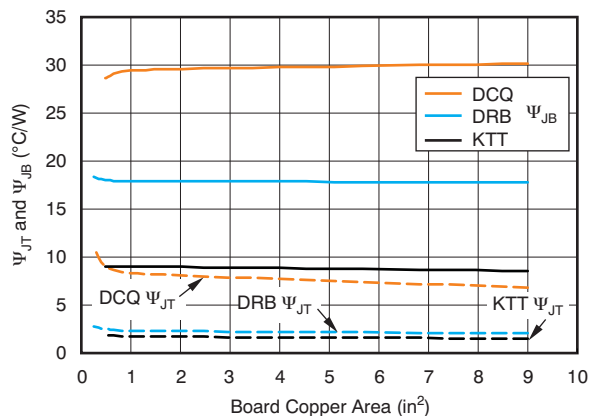
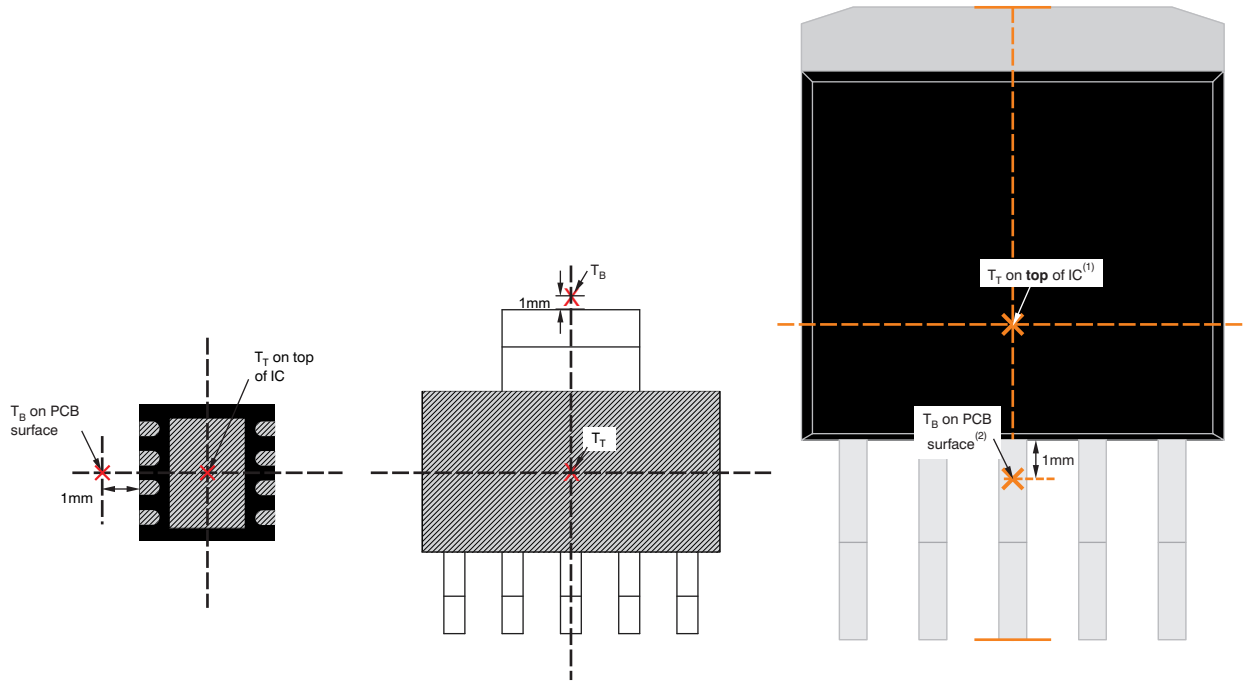

Figure 33. Ψ_{JT} and Ψ_{JB} vs Board Size

For a more detailed discussion of why TI does not recommend using $\theta_{JC(top)}$ to determine thermal characteristics, see application report *Using New Thermal Metrics*, [SBVA025](#), available for download at [www.ti.com](#). For further information, see application report *IC Package Thermal Metrics*, [SPRA953](#), also available on the TI website.



(a) Example DRB (VSON) Package Measurement

(b) Example DCQ (SOT-223) Package Measurement

(c) Example KTT (TO-263) Package Measurement

- (1) T_T is measured at the center of both the X- and Y-dimensional axes.
- (2) T_B is measured **below** the package lead on the PCB surface.

Figure 34. Measuring Points for T_T and T_B

11 Device and Documentation Support

11.1 Device Support

11.1.1 Development Support

11.1.1.1 Evaluation Modules

An evaluation module (EVM) is available to assist in the initial circuit performance evaluation using the TPS786. This EVM, [TPS78601DRBEVM](#) Single Output LDO, can be requested at the Texas Instruments website through the product folders or purchased directly from the [TI eStore](#).

11.1.1.2 Spice Models

Computer simulation of circuit performance using SPICE is often useful when analyzing the performance of analog circuits and systems. A SPICE model for the TPS786 devices are available through the product folders under simulation models.

11.1.2 Device Nomenclature

Table 2. Ordering Information

| PRODUCT | V _{OUT} ⁽¹⁾ |
|--------------|---|
| TPS786xxyyyz | XX is nominal output voltage (for example, 28 = 2.8 V, 285 = 2.85 V, 01 = Adjustable). YYY is package designator. Z is package quantity. |

(1) Output voltages from 1.3 V to 5.0 V in 100-mV increments are available; minimum order quantities may apply. Contact factory for details and availability.

11.2 Documentation Support

11.2.1 Related Documentation

For related documentation see the following:

- *Using New Thermal Metrics*, [SBVA025](#).
- *Semiconductor and IC Package Thermal Metrics*, [SPRA953](#).
- *Solder Pad Recommendations for Surface-Mount Devices*, [SBFA015](#).

11.3 Community Resources

The following links connect to TI community resources. Linked contents are provided "AS IS" by the respective contributors. They do not constitute TI specifications and do not necessarily reflect TI's views; see TI's [Terms of Use](#).

TI E2E™ Online Community *TI's Engineer-to-Engineer (E2E) Community*. Created to foster collaboration among engineers. At e2e.ti.com, you can ask questions, share knowledge, explore ideas and help solve problems with fellow engineers.

Design Support *TI's Design Support* Quickly find helpful E2E forums along with design support tools and contact information for technical support.

11.4 Trademarks

E2E is a trademark of Texas Instruments.
 PowerPAD is a trademark of Texas Instruments Inc.
 Bluetooth is a registered trademark of Bluetooth SIG, Inc.
 All other trademarks are the property of their respective owners.

11.5 Electrostatic Discharge Caution



These devices have limited built-in ESD protection. The leads should be shorted together or the device placed in conductive foam during storage or handling to prevent electrostatic damage to the MOS gates.

11.6 Glossary

[SLYZ022](#) — *TI Glossary*.

This glossary lists and explains terms, acronyms, and definitions.

12 Mechanical, Packaging, and Orderable Information

The following pages include mechanical, packaging, and orderable information. This information is the most current data available for the designated devices. This data is subject to change without notice and revision of this document. For browser-based versions of this data sheet, refer to the left-hand navigation.

PACKAGING INFORMATION

| Orderable Device | Status (1) | Package Type | Package Drawing | Pins | Package Qty | Eco Plan (2) | Lead finish/ Ball material (6) | MSL Peak Temp (3) | Op Temp (°C) | Device Marking (4/5) | Samples |
|------------------|---------------|------------------|-----------------|------|-------------|-----------------|--------------------------------------|----------------------|--------------|-------------------------|-------------------------|
| TPS78601DCQ | ACTIVE | SOT-223 | DCQ | 6 | 78 | RoHS & Green | SN | Level-2-260C-1 YEAR | -40 to 125 | PS78601 | Samples |
| TPS78601DCQR | ACTIVE | SOT-223 | DCQ | 6 | 2500 | RoHS & Green | SN | Level-2-260C-1 YEAR | -40 to 125 | PS78601 | Samples |
| TPS78601DCQRG4 | ACTIVE | SOT-223 | DCQ | 6 | 2500 | RoHS & Green | NIPDAU | Level-2-260C-1 YEAR | -40 to 125 | PS78601 | Samples |
| TPS78601DRBR | ACTIVE | SON | DRB | 8 | 3000 | RoHS & Green | NIPDAU | Level-2-260C-1 YEAR | -40 to 125 | OCI | Samples |
| TPS78601DRBT | ACTIVE | SON | DRB | 8 | 250 | RoHS & Green | NIPDAU | Level-2-260C-1 YEAR | -40 to 125 | OCI | Samples |
| TPS78601KTTR | ACTIVE | DDPAK/ TO-263 | KTT | 5 | 500 | RoHS & Green | Call TI SN | Level-2-260C-1 YEAR | | TPS 78601 | Samples |
| TPS78601KTTRG3 | ACTIVE | DDPAK/ TO-263 | KTT | 5 | 500 | RoHS & Green | SN | Level-2-260C-1 YEAR | | TPS 78601 | Samples |
| TPS78618DCQ | ACTIVE | SOT-223 | DCQ | 6 | 78 | RoHS & Green | NIPDAU | Level-2-260C-1 YEAR | -40 to 125 | PS78618 | Samples |
| TPS78618DCQR | ACTIVE | SOT-223 | DCQ | 6 | 2500 | RoHS & Green | NIPDAU | Level-2-260C-1 YEAR | -40 to 125 | PS78618 | Samples |
| TPS78618KTTR | ACTIVE | DDPAK/ TO-263 | KTT | 5 | 500 | RoHS & Green | Call TI SN | Level-2-260C-1 YEAR | | TPS 78618 | Samples |
| TPS78618KTTRG3 | ACTIVE | DDPAK/ TO-263 | KTT | 5 | 500 | RoHS & Green | SN | Level-2-260C-1 YEAR | | TPS 78618 | Samples |
| TPS78625DCQ | ACTIVE | SOT-223 | DCQ | 6 | 78 | RoHS & Green | NIPDAU | Level-2-260C-1 YEAR | -40 to 125 | PS78625 | Samples |
| TPS78625DCQG4 | ACTIVE | SOT-223 | DCQ | 6 | 78 | RoHS & Green | NIPDAU | Level-2-260C-1 YEAR | -40 to 125 | PS78625 | Samples |
| TPS78625DCQR | ACTIVE | SOT-223 | DCQ | 6 | 2500 | RoHS & Green | NIPDAU | Level-2-260C-1 YEAR | -40 to 125 | PS78625 | Samples |
| TPS78625KTTR | ACTIVE | DDPAK/ TO-263 | KTT | 5 | 500 | RoHS & Green | Call TI SN | Level-2-260C-1 YEAR | | TPS 78625 | Samples |
| TPS78628DCQR | ACTIVE | SOT-223 | DCQ | 6 | 2500 | RoHS & Green | NIPDAU | Level-2-260C-1 YEAR | -40 to 125 | PS78628 | Samples |
| TPS78628KTTT | ACTIVE | DDPAK/ TO-263 | KTT | 5 | 50 | RoHS & Green | Call TI SN | Level-2-260C-1 YEAR | -40 to 125 | TPS 78628 | Samples |
| TPS78630DCQ | ACTIVE | SOT-223 | DCQ | 6 | 78 | RoHS & Green | NIPDAU | Level-2-260C-1 YEAR | -40 to 125 | PS78630 | Samples |
| TPS78630DCQR | ACTIVE | SOT-223 | DCQ | 6 | 2500 | RoHS & Green | NIPDAU | Level-2-260C-1 YEAR | -40 to 125 | PS78630 | Samples |

| Orderable Device | Status (1) | Package Type | Package Drawing | Pins | Package Qty | Eco Plan (2) | Lead finish/ Ball material (6) | MSL Peak Temp (3) | Op Temp (°C) | Device Marking (4/5) | Samples |
|------------------|---------------|------------------|-----------------|------|-------------|-----------------|--------------------------------------|----------------------|--------------|-------------------------|-------------------------|
| TPS78630KTTT | ACTIVE | DDPAK/ TO-263 | KTT | 5 | 50 | RoHS & Green | Call TI SN | Level-2-260C-1 YEAR | -40 to 125 | TPS 78630 | Samples |
| TPS78633DCQ | ACTIVE | SOT-223 | DCQ | 6 | 78 | RoHS & Green | NIPDAU | Level-2-260C-1 YEAR | -40 to 125 | PS78633 | Samples |
| TPS78633DCQG4 | ACTIVE | SOT-223 | DCQ | 6 | 78 | RoHS & Green | NIPDAU | Level-2-260C-1 YEAR | -40 to 125 | PS78633 | Samples |
| TPS78633DCQR | ACTIVE | SOT-223 | DCQ | 6 | 2500 | RoHS & Green | NIPDAU | Level-2-260C-1 YEAR | -40 to 125 | PS78633 | Samples |
| TPS78633DCQRG4 | ACTIVE | SOT-223 | DCQ | 6 | 2500 | TBD | Call TI | Call TI | -40 to 125 | | Samples |
| TPS78633KTTR | ACTIVE | DDPAK/ TO-263 | KTT | 5 | 500 | RoHS & Green | Call TI SN | Level-2-260C-1 YEAR | | TPS 78633 | Samples |
| TPS78633KTTRG3 | ACTIVE | DDPAK/ TO-263 | KTT | 5 | 500 | RoHS & Green | SN | Level-2-260C-1 YEAR | | TPS 78633 | Samples |

(1) The marketing status values are defined as follows:

ACTIVE: Product device recommended for new designs.

LIFEBUY: TI has announced that the device will be discontinued, and a lifetime-buy period is in effect.

NRND: Not recommended for new designs. Device is in production to support existing customers, but TI does not recommend using this part in a new design.

PREVIEW: Device has been announced but is not in production. Samples may or may not be available.

OBSOLETE: TI has discontinued the production of the device.

(2) **RoHS:** TI defines "RoHS" to mean semiconductor products that are compliant with the current EU RoHS requirements for all 10 RoHS substances, including the requirement that RoHS substance do not exceed 0.1% by weight in homogeneous materials. Where designed to be soldered at high temperatures, "RoHS" products are suitable for use in specified lead-free processes. TI may reference these types of products as "Pb-Free".

RoHS Exempt: TI defines "RoHS Exempt" to mean products that contain lead but are compliant with EU RoHS pursuant to a specific EU RoHS exemption.

Green: TI defines "Green" to mean the content of Chlorine (Cl) and Bromine (Br) based flame retardants meet JS709B low halogen requirements of <=1000ppm threshold. Antimony trioxide based flame retardants must also meet the <=1000ppm threshold requirement.

(3) MSL, Peak Temp. - The Moisture Sensitivity Level rating according to the JEDEC industry standard classifications, and peak solder temperature.

(4) There may be additional marking, which relates to the logo, the lot trace code information, or the environmental category on the device.

(5) Multiple Device Markings will be inside parentheses. Only one Device Marking contained in parentheses and separated by a "~" will appear on a device. If a line is indented then it is a continuation of the previous line and the two combined represent the entire Device Marking for that device.

(6) Lead finish/Ball material - Orderable Devices may have multiple material finish options. Finish options are separated by a vertical ruled line. Lead finish/Ball material values may wrap to two lines if the finish value exceeds the maximum column width.

Important Information and Disclaimer: The information provided on this page represents TI's knowledge and belief as of the date that it is provided. TI bases its knowledge and belief on information provided by third parties, and makes no representation or warranty as to the accuracy of such information. Efforts are underway to better integrate information from third parties. TI has taken and continues to take reasonable steps to provide representative and accurate information but may not have conducted destructive testing or chemical analysis on incoming materials and chemicals. TI and TI suppliers consider certain information to be proprietary, and thus CAS numbers and other limited information may not be available for release.

In no event shall TI's liability arising out of such information exceed the total purchase price of the TI part(s) at issue in this document sold by TI to Customer on an annual basis.

TAPE AND REEL INFORMATION

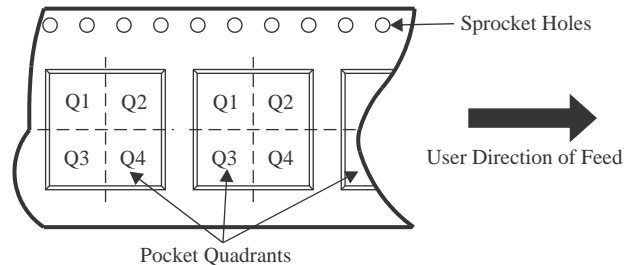
QUADRANT ASSIGNMENTS FOR PIN 1 ORIENTATION IN TAPE

*All dimensions are nominal

| Device | Package Type | Package Drawing | Pins | SPQ | Reel Diameter (mm) | Reel Width W1 (mm) | A0 (mm) | B0 (mm) | K0 (mm) | P1 (mm) | W (mm) | Pin1 Quadrant |
|----------------|--------------|-----------------|------|------|--------------------|--------------------|---------|---------|---------|---------|--------|---------------|
| TPS78601DCQR | SOT-223 | DCQ | 6 | 2500 | 330.0 | 12.4 | 7.1 | 7.45 | 1.88 | 8.0 | 12.0 | Q3 |
| TPS78601DCQRG4 | SOT-223 | DCQ | 6 | 2500 | 330.0 | 12.4 | 7.1 | 7.45 | 1.88 | 8.0 | 12.0 | Q3 |
| TPS78601DRBR | SON | DRB | 8 | 3000 | 330.0 | 12.4 | 3.3 | 3.3 | 1.1 | 8.0 | 12.0 | Q2 |
| TPS78601DRBT | SON | DRB | 8 | 250 | 180.0 | 12.4 | 3.3 | 3.3 | 1.1 | 8.0 | 12.0 | Q2 |
| TPS78618DCQR | SOT-223 | DCQ | 6 | 2500 | 330.0 | 12.4 | 7.1 | 7.45 | 1.88 | 8.0 | 12.0 | Q3 |
| TPS78625DCQR | SOT-223 | DCQ | 6 | 2500 | 330.0 | 12.4 | 7.1 | 7.45 | 1.88 | 8.0 | 12.0 | Q3 |
| TPS78628DCQR | SOT-223 | DCQ | 6 | 2500 | 330.0 | 12.4 | 7.1 | 7.45 | 1.88 | 8.0 | 12.0 | Q3 |
| TPS78630DCQR | SOT-223 | DCQ | 6 | 2500 | 330.0 | 12.4 | 7.1 | 7.45 | 1.88 | 8.0 | 12.0 | Q3 |
| TPS78633DCQR | SOT-223 | DCQ | 6 | 2500 | 330.0 | 12.4 | 7.1 | 7.45 | 1.88 | 8.0 | 12.0 | Q3 |

TAPE AND REEL BOX DIMENSIONS

*All dimensions are nominal

| Device | Package Type | Package Drawing | Pins | SPQ | Length (mm) | Width (mm) | Height (mm) |
|----------------|--------------|-----------------|------|------|-------------|------------|-------------|
| TPS78601DCQR | SOT-223 | DCQ | 6 | 2500 | 356.0 | 356.0 | 35.0 |
| TPS78601DCQRG4 | SOT-223 | DCQ | 6 | 2500 | 346.0 | 346.0 | 29.0 |
| TPS78601DRBR | SON | DRB | 8 | 3000 | 356.0 | 356.0 | 35.0 |
| TPS78601DRBT | SON | DRB | 8 | 250 | 210.0 | 185.0 | 35.0 |
| TPS78618DCQR | SOT-223 | DCQ | 6 | 2500 | 346.0 | 346.0 | 29.0 |
| TPS78625DCQR | SOT-223 | DCQ | 6 | 2500 | 346.0 | 346.0 | 29.0 |
| TPS78628DCQR | SOT-223 | DCQ | 6 | 2500 | 346.0 | 346.0 | 41.0 |
| TPS78630DCQR | SOT-223 | DCQ | 6 | 2500 | 346.0 | 346.0 | 41.0 |
| TPS78633DCQR | SOT-223 | DCQ | 6 | 2500 | 346.0 | 346.0 | 29.0 |

TUBE

*All dimensions are nominal

| Device | Package Name | Package Type | Pins | SPQ | L (mm) | W (mm) | T (μm) | B (mm) |
|---------------|--------------|--------------|------|-----|--------|--------|--------|--------|
| TPS78601DCQ | DCQ | SOT-223 | 6 | 78 | 543 | 8.6 | 3606.8 | 2.67 |
| TPS78618DCQ | DCQ | SOT-223 | 6 | 78 | 532.13 | 8.63 | 3.6 | 3.68 |
| TPS78625DCQ | DCQ | SOT-223 | 6 | 78 | 532.13 | 8.63 | 3.6 | 3.68 |
| TPS78625DCQG4 | DCQ | SOT-223 | 6 | 78 | 532.13 | 8.63 | 3.6 | 3.68 |
| TPS78630DCQ | DCQ | SOT-223 | 6 | 78 | 532.13 | 8.63 | 3.6 | 3.68 |
| TPS78633DCQ | DCQ | SOT-223 | 6 | 78 | 532.13 | 8.63 | 3.6 | 3.68 |
| TPS78633DCQG4 | DCQ | SOT-223 | 6 | 78 | 532.13 | 8.63 | 3.6 | 3.68 |

KTT (R-PSFM-G5)

PLASTIC FLANGE-MOUNT PACKAGE

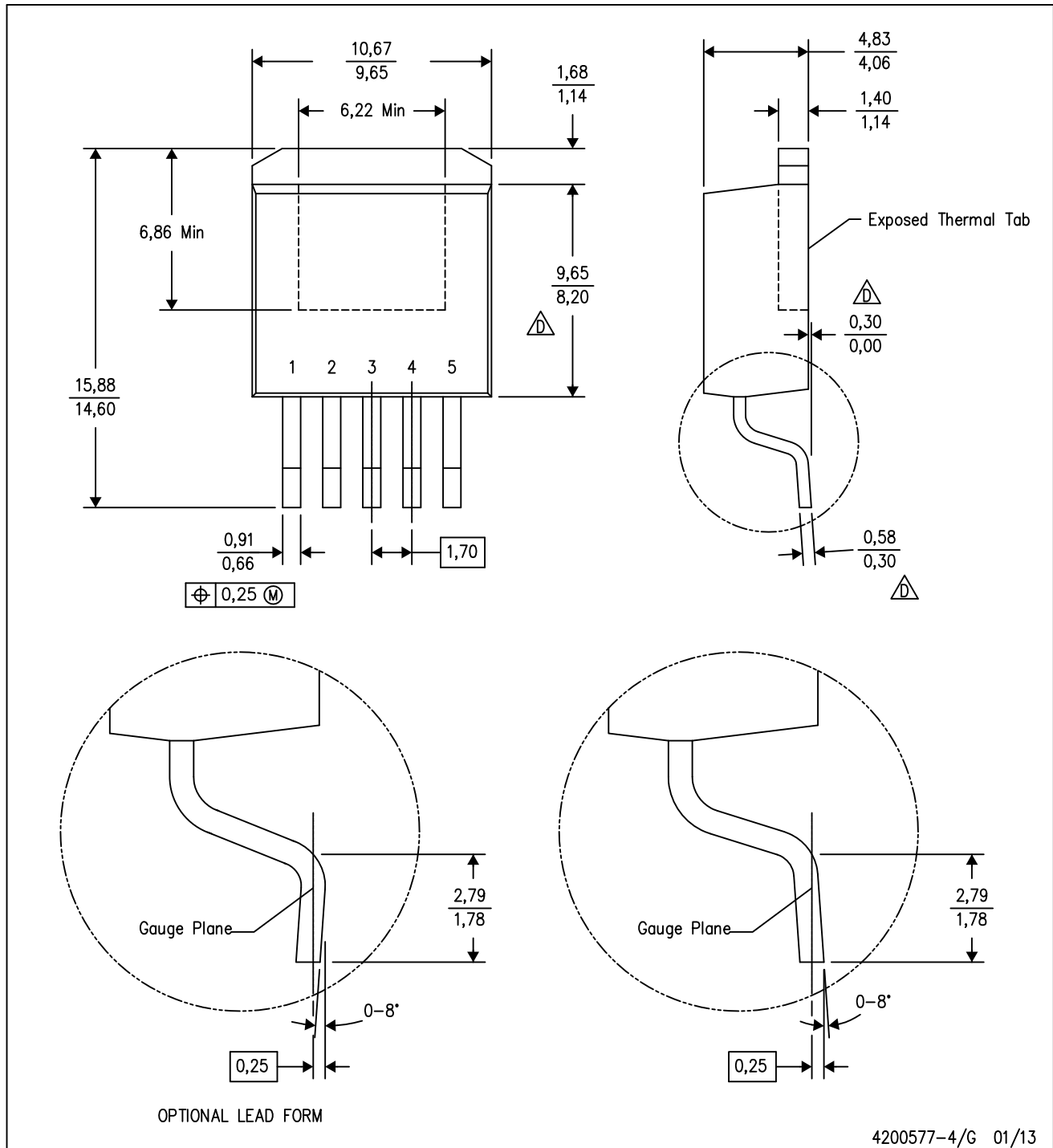

- NOTES:
- A. All linear dimensions are in millimeters.
 - B. This drawing is subject to change without notice.
 - C. Body dimensions do not include mold flash or protrusion. Mold flash or protrusion not to exceed 0.005 (0,13) per side.
- △ Falls within JEDEC TO-263 variation BA, except minimum lead thickness, maximum seating height, and minimum body length.

KTT (R-PSFM-G5)

PLASTIC FLANGE-MOUNT PACKAGE

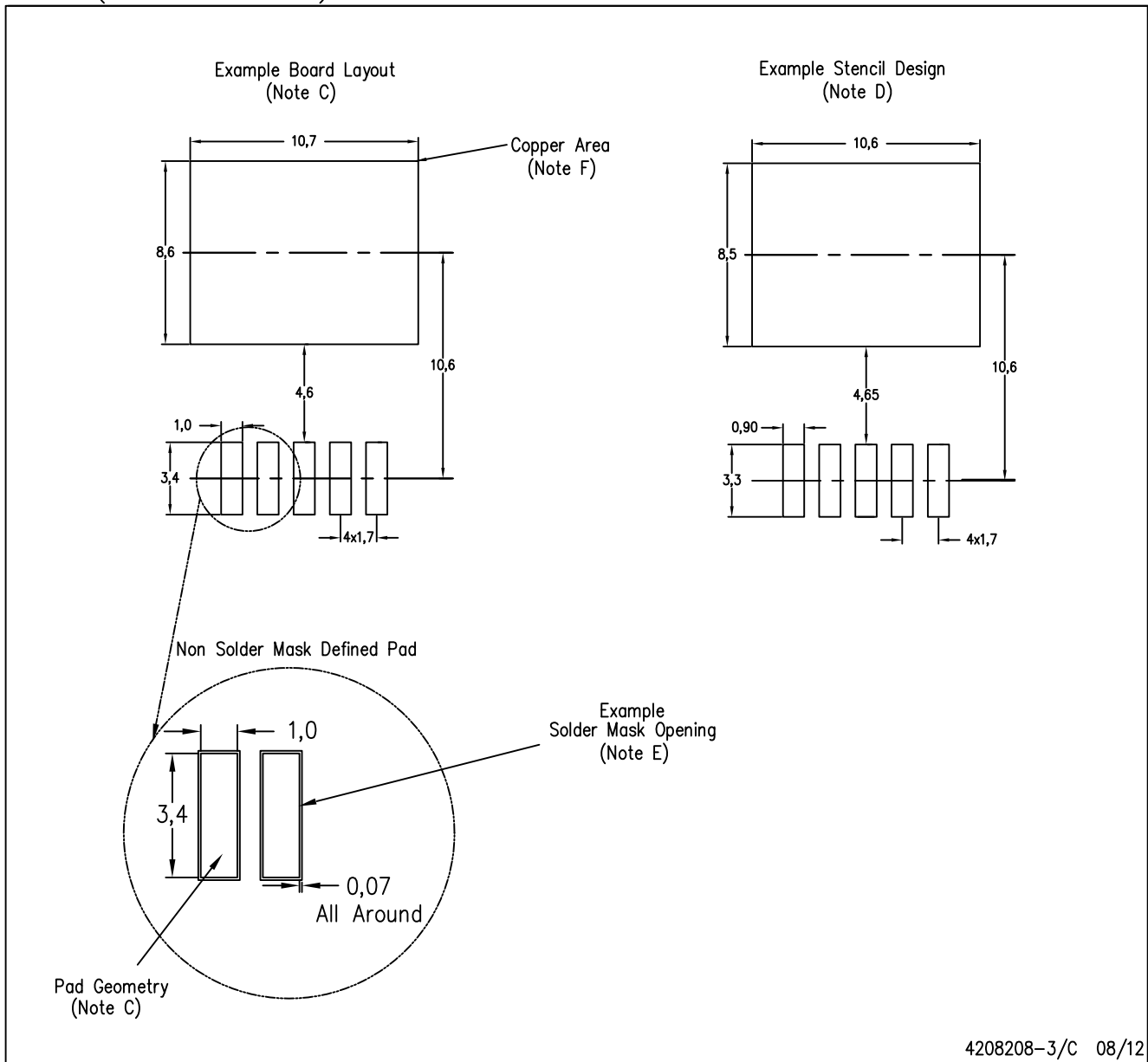

- NOTES:
- All linear dimensions are in millimeters.
 - This drawing is subject to change without notice.
 - Publication IPC-SM-782 is recommended for alternate designs.
 - Laser cutting apertures with trapezoidal walls and also rounding corners will offer better paste release. Customers should contact their board assembly site for stencil design recommendations. Refer to IPC-7525.
 - Customers should contact their board fabrication site for solder mask tolerances between and around signal pads.
 - This package is designed to be soldered to a thermal pad on the board. Refer to the Product Datasheet for specific thermal information, via requirements, and recommended thermal pad size. For thermal pad sizes larger than shown a solder mask defined pad is recommended in order to maintain the solderable pad geometry while increasing copper area.

DCQ0006A

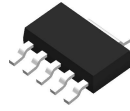

PACKAGE OUTLINE

SOT - 1.8 mm max height

PLASTIC SMALL OUTLINE

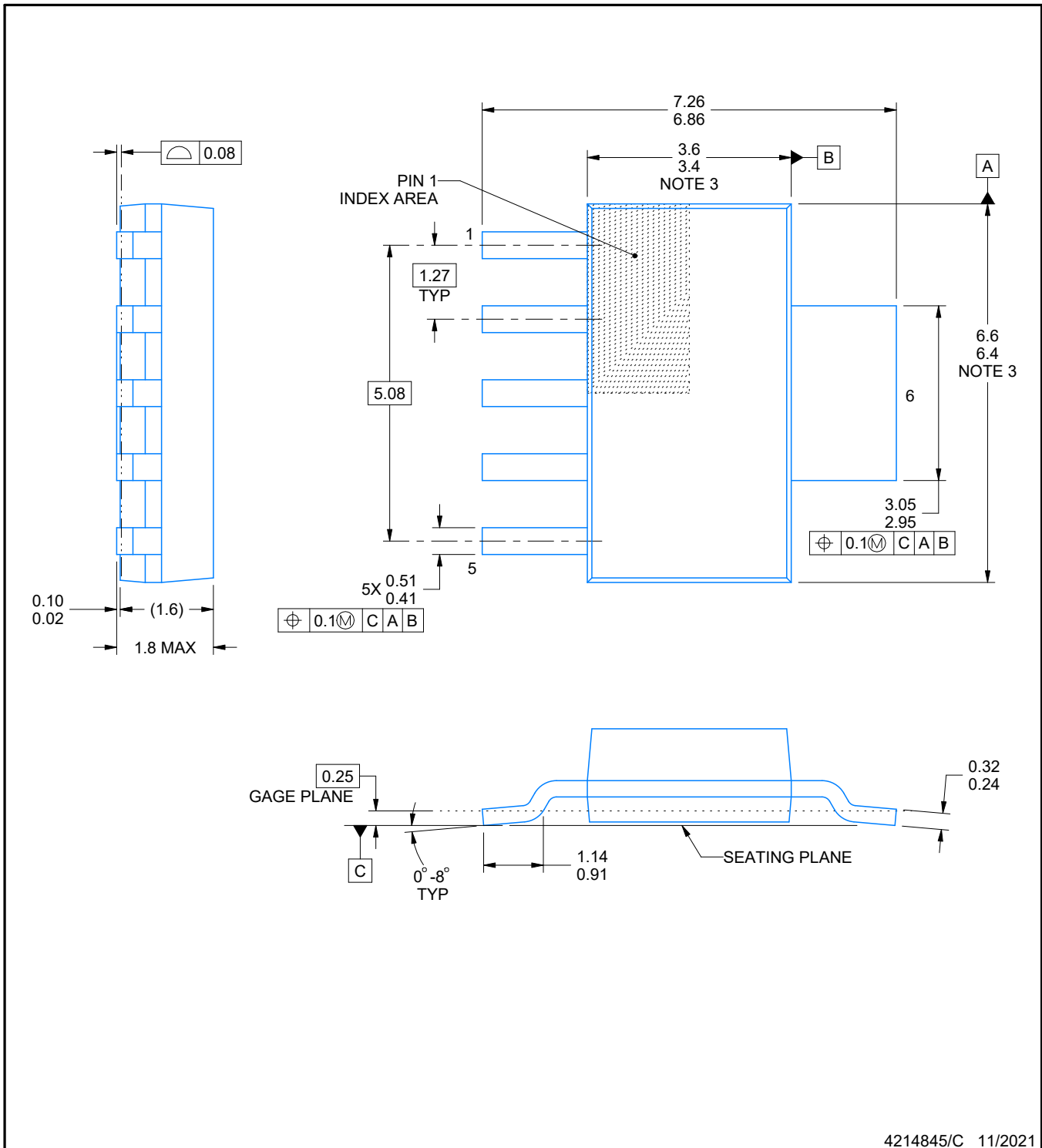

4214845/C 11/2021

NOTES:

1. All linear dimensions are in millimeters. Any dimensions in parenthesis are for reference only. Dimensioning and tolerancing per ASME Y14.5M.
2. This drawing is subject to change without notice.
3. This dimension does not include mold flash, protrusions, or gate burrs. Mold flash, protrusions, or gate burrs shall not exceed 0.15 mm per side.

EXAMPLE BOARD LAYOUT

DCQ0006A

SOT - 1.8 mm max height

PLASTIC SMALL OUTLINE

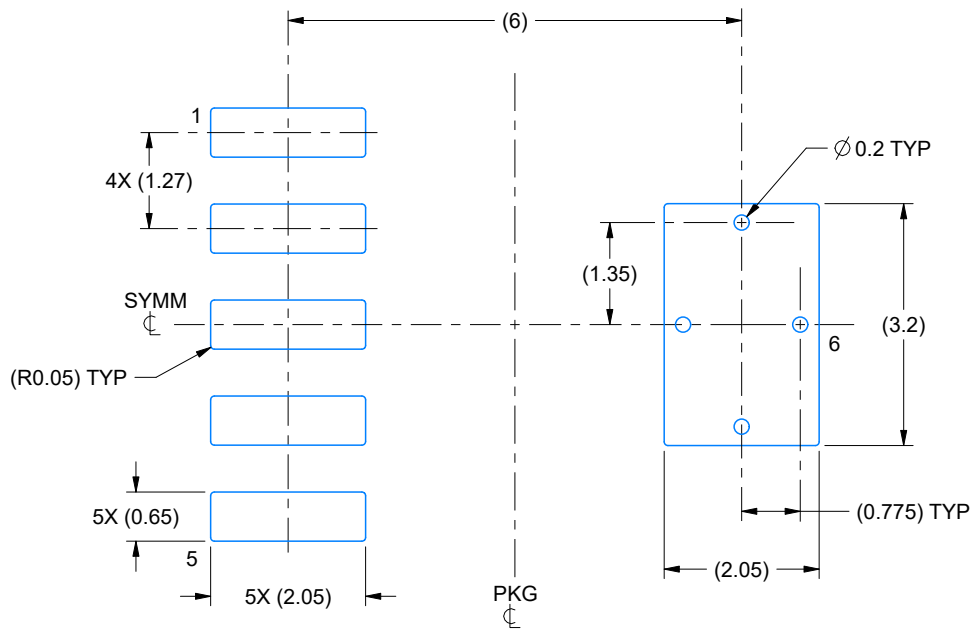

LAND PATTERN EXAMPLE
EXPOSED METAL SHOWN
SCALE: 10X

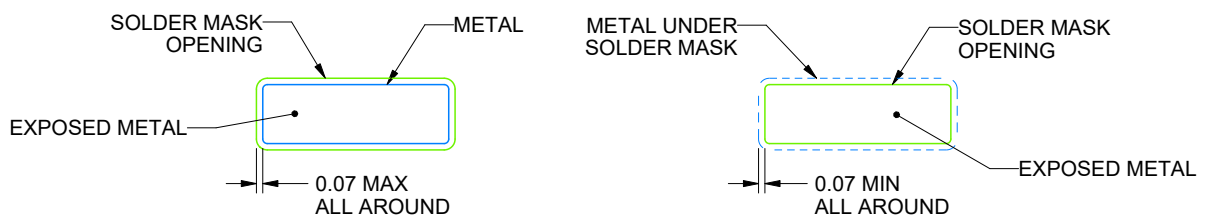

SOLDER MASK DETAILS

4214845/C 11/2021

NOTES: (continued)

4. Publication IPC-7351 may have alternate designs.
5. Solder mask tolerances between and around signal pads can vary based on board fabrication site.
6. Vias are optional depending on application, refer to device data sheet. If any vias are implemented, refer to their locations shown on this view. It is recommended that vias under paste be filled, plugged or tented.

EXAMPLE STENCIL DESIGN

DCQ0006A

SOT - 1.8 mm max height

PLASTIC SMALL OUTLINE

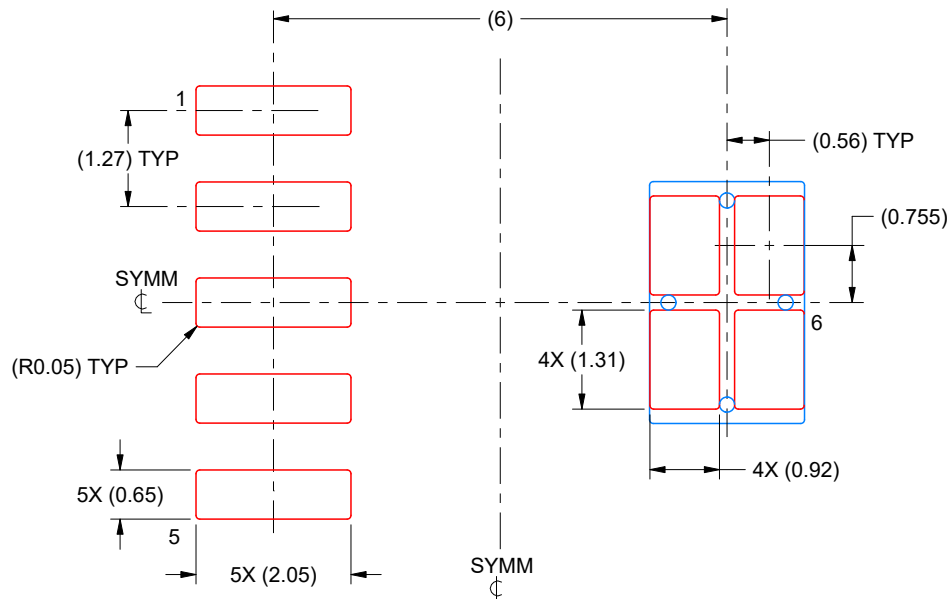

SOLDER PASTE EXAMPLE
BASED ON 0.125 mm THICK STENCIL
SCALE: 10X

4214845/C 11/2021

NOTES: (continued)

7. Laser cutting apertures with trapezoidal walls and rounded corners may offer better paste release. IPC-7525 may have alternate design recommendations.
8. Board assembly site may have different recommendations for stencil design.

DRB 8

GENERIC PACKAGE VIEW

VSON - 1 mm max height

PLASTIC SMALL OUTLINE - NO LEAD

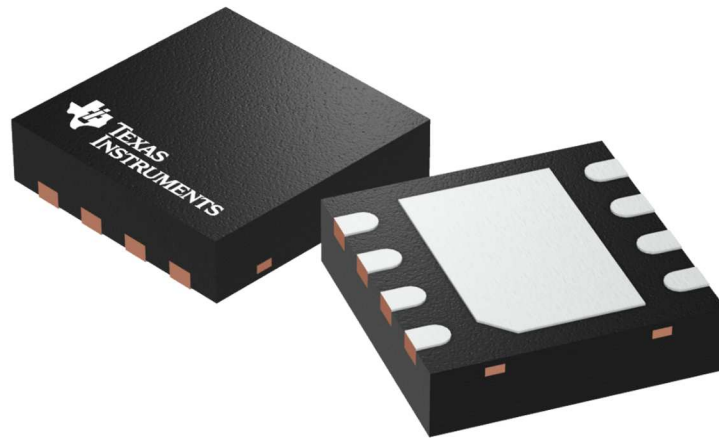

Images above are just a representation of the package family, actual package may vary.
Refer to the product data sheet for package details.

4203482/L

EXAMPLE BOARD LAYOUT

DRB0008B

VSON - 1 mm max height

PLASTIC SMALL OUTLINE - NO LEAD



LAND PATTERN EXAMPLE
SCALE:20X



SOLDER MASK DETAILS

4218876/A 12/2017

NOTES: (continued)

4. This package is designed to be soldered to a thermal pad on the board. For more information, see Texas Instruments literature number SLUA271 (www.ti.com/lit/sluea271).
5. Vias are optional depending on application, refer to device data sheet. If any vias are implemented, refer to their locations shown on this view. It is recommended that vias under paste be filled, plugged or tented.

EXAMPLE STENCIL DESIGN

DRB0008B

VSON - 1 mm max height

PLASTIC SMALL OUTLINE - NO LEAD



SOLDER PASTE EXAMPLE
BASED ON 0.125 mm THICK STENCIL
EXPOSED PAD
81% PRINTED SOLDER COVERAGE BY AREA
SCALE:25X

4218876/A 12/2017

NOTES: (continued)

6. Laser cutting apertures with trapezoidal walls and rounded corners may offer better paste release. IPC-7525 may have alternate design recommendations.

IMPORTANT NOTICE AND DISCLAIMER

TI PROVIDES TECHNICAL AND RELIABILITY DATA (INCLUDING DATA SHEETS), DESIGN RESOURCES (INCLUDING REFERENCE DESIGNS), APPLICATION OR OTHER DESIGN ADVICE, WEB TOOLS, SAFETY INFORMATION, AND OTHER RESOURCES "AS IS" AND WITH ALL FAULTS, AND DISCLAIMS ALL WARRANTIES, EXPRESS AND IMPLIED, INCLUDING WITHOUT LIMITATION ANY IMPLIED WARRANTIES OF MERCHANTABILITY, FITNESS FOR A PARTICULAR PURPOSE OR NON-INFRINGEMENT OF THIRD PARTY INTELLECTUAL PROPERTY RIGHTS.

These resources are intended for skilled developers designing with TI products. You are solely responsible for (1) selecting the appropriate TI products for your application, (2) designing, validating and testing your application, and (3) ensuring your application meets applicable standards, and any other safety, security, regulatory or other requirements.

These resources are subject to change without notice. TI grants you permission to use these resources only for development of an application that uses the TI products described in the resource. Other reproduction and display of these resources is prohibited. No license is granted to any other TI intellectual property right or to any third party intellectual property right. TI disclaims responsibility for, and you will fully indemnify TI and its representatives against, any claims, damages, costs, losses, and liabilities arising out of your use of these resources.

TI's products are provided subject to [TI's Terms of Sale](#) or other applicable terms available either on ti.com or provided in conjunction with such TI products. TI's provision of these resources does not expand or otherwise alter TI's applicable warranties or warranty disclaimers for TI products.

TI objects to and rejects any additional or different terms you may have proposed.

Mailing Address: Texas Instruments, Post Office Box 655303, Dallas, Texas 75265
Copyright © 2022, Texas Instruments Incorporated