

ANY-OUT™ Low-Dropout Regulator Controlled by I²C™ IO Expander Device

Masashi Nogawa

Power Management Products

ABSTRACT

Recent low-dropout (LDO) linear voltage regulator devices from Texas Instruments feature a new function termed *ANY-OUT*. With an ANY-OUT LDO regulator, the device output voltage can be programmed by selecting the binary-weighted device pins to either be ground or float. This ANY-OUT method of selecting two options (to ground or to float) has very good compatibility with well-known digital control methods such as I²C or PMBus™.

In this document, a PC control example of an ANY-OUT LDO regulator using I²C is demonstrated. This example indicates that the ANY-OUT function is a good solution for digital control capability demands in the voltage regulator market.

Contents

1	Materials	2
2	Preparing the I ² C IO Expander Board	2
3	Preparing the USB-to-I ² C Communication Software on the PC	3
4	System Setup and Operation from a PC	5
5	Summary	11
6	Appendix: List of Released ANY-OUT LDO Regulators	11

List of Figures

1	Schematic of I ² C IO Expander Board	2
2	I ² C IO Expander Board	3
3	Picture of USB-TO-GPIO	3
4	Tool Folder Web Page	4
5	Selecting Required File from Sub-Archive Files	4
6	Total System Connection	5
7	Starting GUI Software	5
8	GUI Screen After Sending the First Line of Initialization Code	6
9	GUI Screen After Sending the Second Line of Initialization Code	7
10	GUI Screen After Sending the Third Line of Initialization Code	7
11	GUI Screen with Failure, After Sending the First Line of Initialization Code	7
12	GUI Screen Reading the PG = L Status After Sending Disable Code	10
13	GUI Screen Reading the PG = H Status After Sending Enable (3.3V Output) Code	10

ANY-OUT is a trademark of Texas Instruments.
 Microsoft is a registered trademark of Microsoft Corporation.
 I²C is a trademark of NXP Semiconductors.
 PMBus is a trademark of SMIF, Inc.
 All other trademarks are the property of their respective owners.

1 Materials

Throughout this document, the following materials are used.

- One ANY-OUT LDO regulator [TPS7A7200RGW](#) on evaluation module: [TPS7A7200EVM-718](#)
- One I²C IO expander device: [PCA9557PW](#)
- One universal serial bus (USB) to general-purpose input/output (GPIO) adaptor: [USB-TO-GPIO](#)
- One blank TSSOP universal (prototyping) board
- One P-type FET
- One USB cable (standard A to mini B)
- Several pin-headers, sockets, and jumper cables
- Two resistors: 3 k Ω \times 2
- One bypass capacitor: 1 μ F

2 Preparing the I²C IO Expander Board

As a first step, prepare the I²C IO expander board with a PCA9557PW device. Figure 1 is the target schematic. To avoid the confusion of handling similar component names on two boards, the pin headers and sockets on this I²C IO expander board are instead referred to as H1 (headers) and S1 and S2 (sockets) to differentiate from the pin header names on the TPS7A7200EVM-718, which begin with *J* or *JP*.

In Figure 1, H1 is a 2-pin \times 5-pin header to a 10-pin ribbon cable that comes with the USB-TO-GPIO. Pins 3, 4, 9, and 10 are used in this document. Pins 3 and 4 provide a power supply to the PCA9557 device. Pins 9 and 10 are the clock and data signals of the I²C interface, respectively.

S1 and S2 are sockets to JP1 and JP5, respectively, on the TPS7A7200EVM-718 board. At the S1 socket, a voltage supply is taken from the TPS7A7200EVM-718 with ON (VCC) and OFF (GND). ON and OFF create a supply that generates a proper EN drive signal (that is, MP1, R1, and R2 form a level shifter). The S2 socket controls the ANY-OUT voltage setting pins. For the ease of connecting two boards, place S1 and S2 in correlation to JP1 and JP5, respectively. Note that J5 is a 7-pin \times 2-pin header on the TPS7A7200EVM-718. Furthermore, be aware of which S2 component is selected.

T1 is a test point that is wire connected to the PG signal (TP1) on the TPS7A7200EVM-718. C1 is a bypass capacitor for the PCA9557.

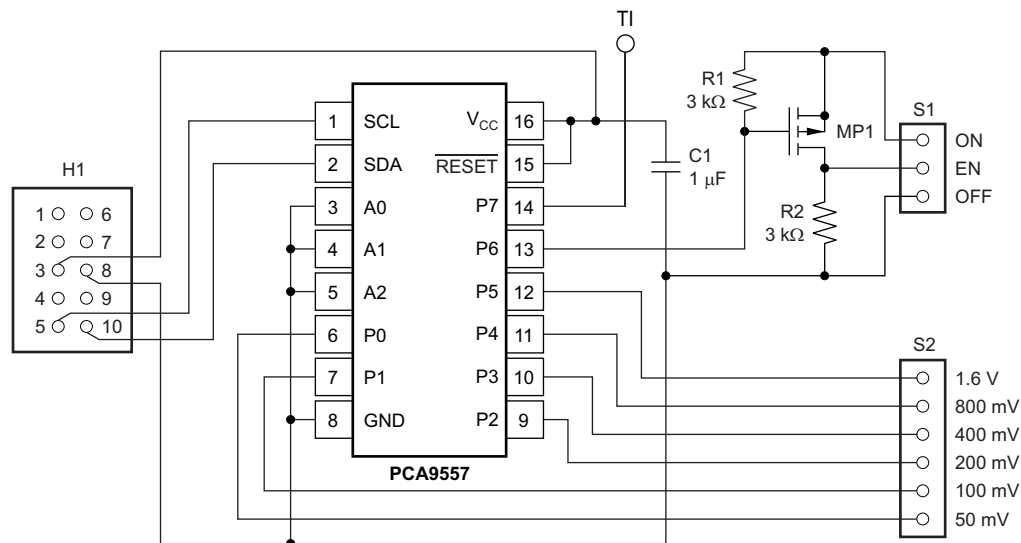

Figure 1. Schematic of I²C IO Expander Board

Figure 2 shows an example of implementing Figure 1. Here, an in-house (not released for public) universal TSSOP board is used. As can be determined from the simple schematic of Figure 1, creating this board takes only a couple of hours.

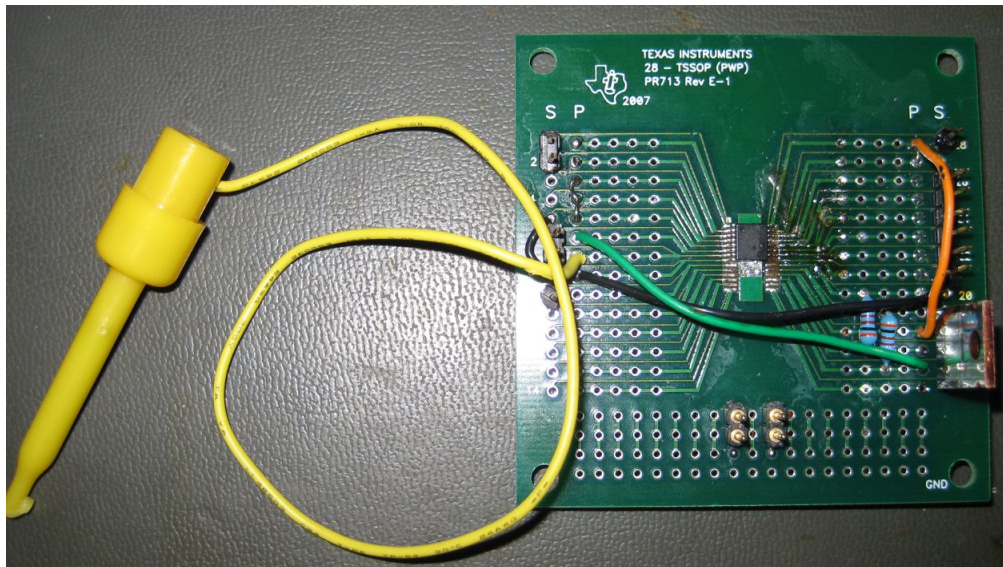

Figure 2. I²C IO Expander Board

3 Preparing the USB-to-I²C Communication Software on the PC

Obtain a USB-TO-GPIO adaptor (as shown in Figure 3), and then download the control software from the Tool folder <http://www.ti.com/tool/usb-to-gpio> by following the *Related Products* → *TI Software* → *Reference GUIs and Libraries for Eval and Usage of the USB Interface Adaptor* (see Figure 4). Download the file *sllc288.zip*. After extracting the zip file, there is one *README.txt* file and three sub-ZIP files; only the contents in the *USB Interface Adaptor GUI-v1.10.zip* are required in this document (see Figure 5). To use this software, *Microsoft Framework version 2.0* is required and is available from the Microsoft® web site. Next, extract the *USB Interface Adaptor GUI-v1.10.zip* file.



Figure 3. Picture of USB-TO-GPIO

Technical Documents

More Literature (1)

Title	Abstract	Type	Size (KB)	Date	Views	TI Recommends
 USB Interface Adapter Evaluation Module		PDF	857	02 Aug 2006	4,832	✓

Related Products

TI Software

TI Devices (9)

[Reference GUIs and Libraries for Eval and Usage of the USB Inteface Adapter](#) (zip 272 KB)

17 Oct 2006 748 views 

Support and Community

Figure 4. Tool Folder Web Page





Name	Size	Type	Date Modified
 README.txt	4 KB	Text Document	10/17/2006 5:59 AM
 USB Interface Adapter Driver.zip	48 KB	WinZip File	10/17/2006 5:39 AM
 PMBus Reference GUI.zip	114 KB	WinZip File	10/17/2006 5:38 AM
 USB Interface Adapter GUI-v1.10.zip	110 KB	WinZip File	10/17/2006 5:35 AM

Figure 5. Selecting Required File from Sub-Archive Files

The [user guide](#), found in the same [tool folder](#) (see upper half of [Figure 4](#)), explains this adaptor and software. Refer to the user guide for further information.

4 System Setup and Operation from a PC

4.1 Interfacing the System Together and Start-Up GUI Program

Preparation is now complete and everything is properly connected. [Figure 6](#) shows an example system setup (note that [Figure 6](#) shows a highly-modified TPS7A7200EVM-718). Although not shown in [Figure 6](#), the USB-TO-GPIO adaptor USB connection is plugged into a host computer. When everything is connected, power up the TPS7A7200EVM-718 board with 4.0 V from a lab supply. Do not forget to connect T1 of the I²C IO expander board to TP1 of the TPS7A7200EVM-718 board by a wire.

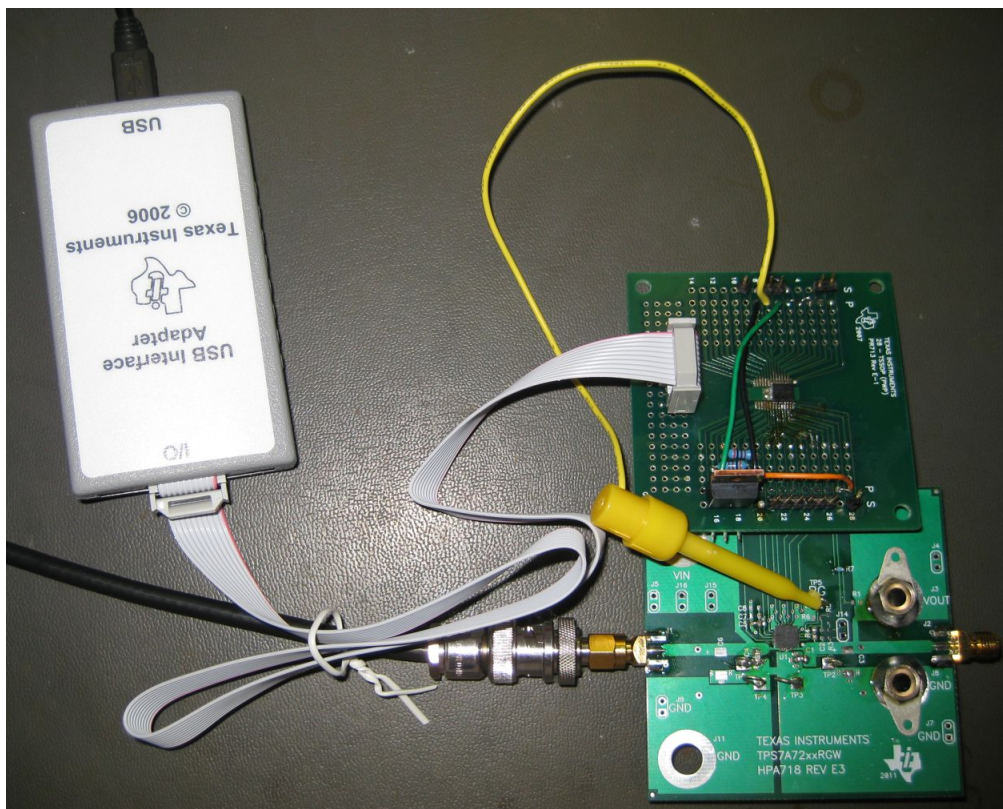

Figure 6. Total System Connection

The TPS7A7200EVM-718 board is now ready to be controlled from the PC. Start the *USB SAA GUI.exe* GUI software (see [Figure 7](#)). In this GUI screen, only the *I²C* and *Pull-up Resistors* control sections are required in this document (see [Figure 8](#)).

Name	Size	Type	Date Modified
USB SAA GUI.xml	1 KB	XML Document	10/17/2006 5:28 AM
USB SAA GUI.pdb	132 KB	PDB File	10/17/2006 5:28 AM
USB SAA GUI.exe	124 KB	Application	10/17/2006 5:28 AM
USB Adapter Driver.xml	1 KB	XML Document	10/10/2006 2:31 PM
USB Adapter Driver.pdb	196 KB	PDB File	10/10/2006 2:31 PM
USB Adapter Driver.dll	72 KB	Application Extensi...	10/10/2006 2:31 PM
USB SAA GUI.vshostexe	6 KB	Application	9/23/2005 7:56 AM

Figure 7. Starting GUI Software

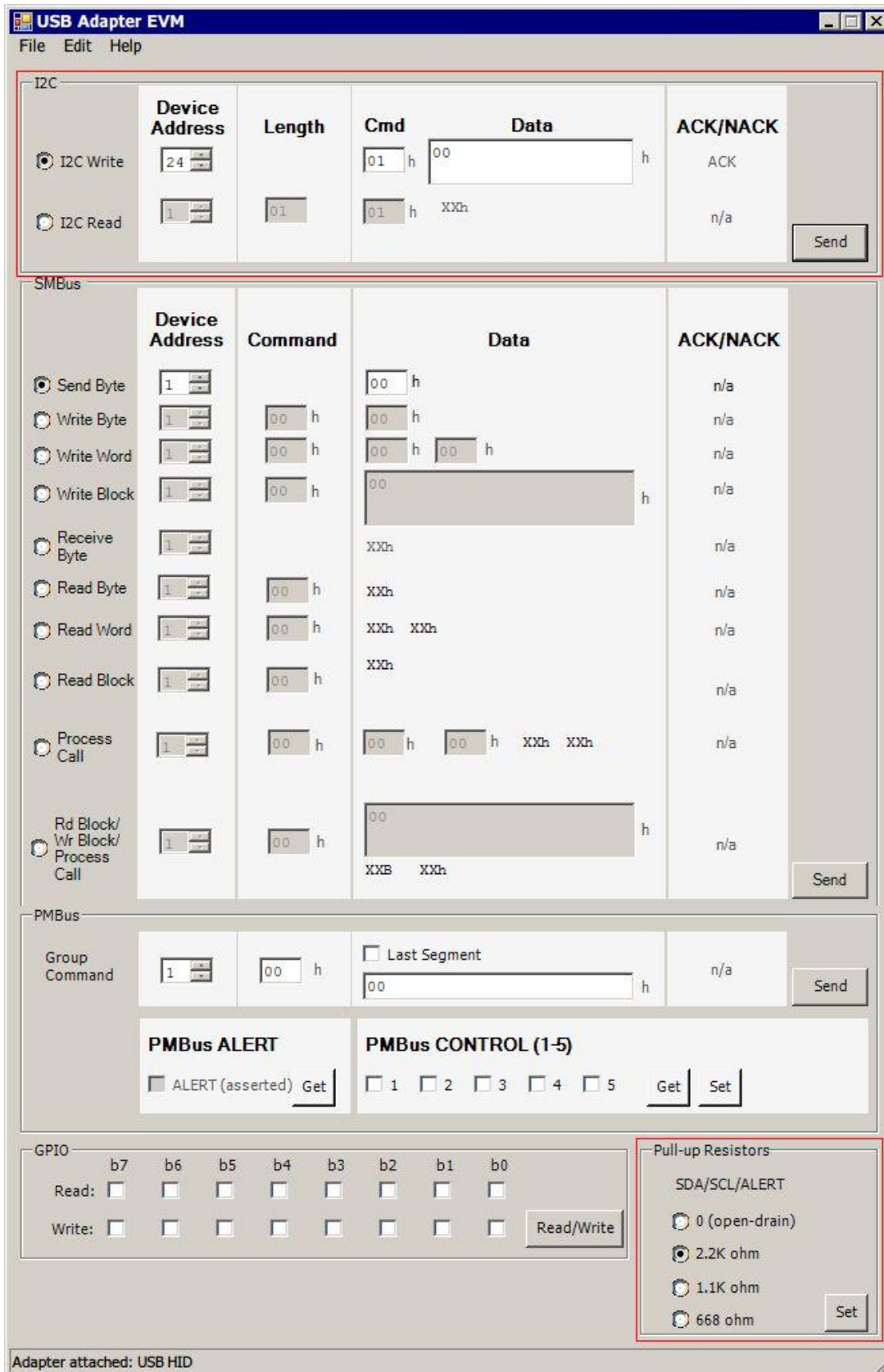

Figure 8. GUI Screen After Sending the First Line of Initialization Code

4.2 Initializing the PCA9557 and the Operation Strategy

The PCA9557 has four control registers. Initialize these registers from the I2C Write function of the GUI software by sending each line of Table 1. Input each line of Table 1 in the GUI and click the Send button in I2C section. Repeat this process for all three lines. Figure 8 shows the result of sending the first line, Figure 9 shows the second line, and Figure 10 shows the third line. When the Send operation is successful, an ACK string should be displayed under the ACK/NACK column, as shown in Figure 8, Figure 9, and Figure 10. If ERROR is shown in the ACK/NACK column (see Figure 11), check the I²C IO expander board and the connections. Because register (Cmd) 00h reads values from the PCA9557, initialization is not needed. In Figure 1, the I²C slave address bits are all connected to GND, which selects 24 (decimal) or 18 (hex) as the address when combined with the fixed address bits within the PCA9557 (see page 7 of the PCA9557 data sheet).

Table 1. PCA9557 Initialization Code

DEVICE ADDRESS	LENGTH	CMD	DATA
24	n/a	01h	00h
24	n/a	02h	00h
24	n/a	03h	FFh

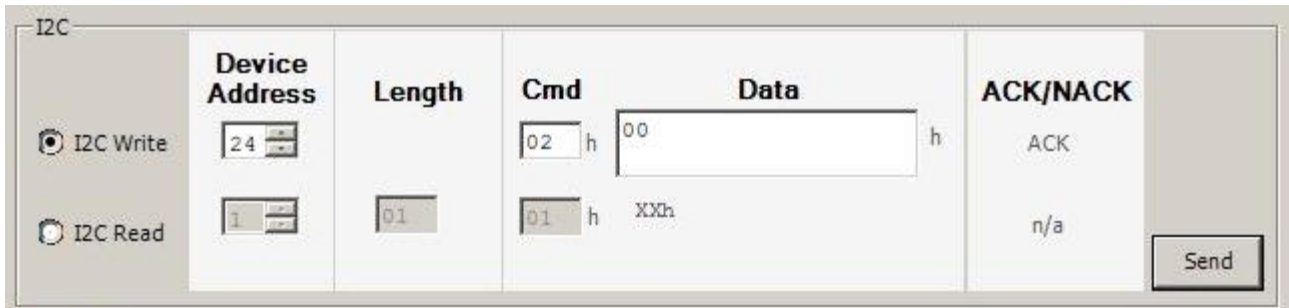

Figure 9. GUI Screen After Sending the Second Line of Initialization Code

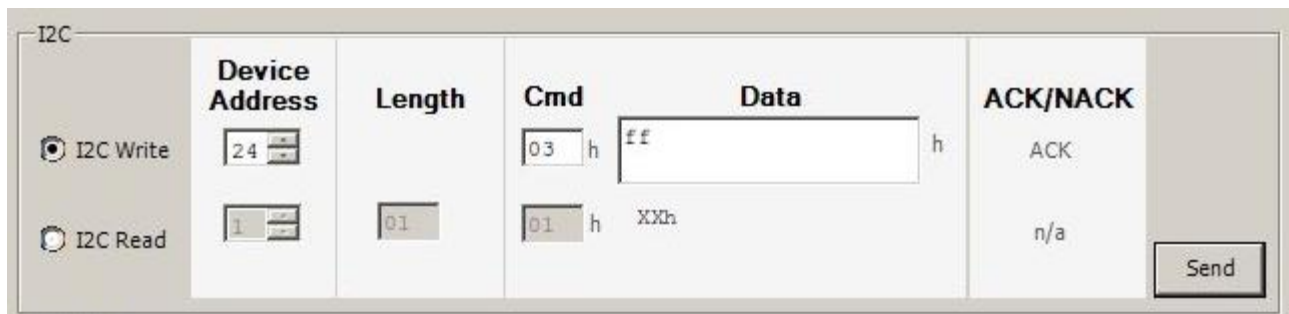

Figure 10. GUI Screen After Sending the Third Line of Initialization Code

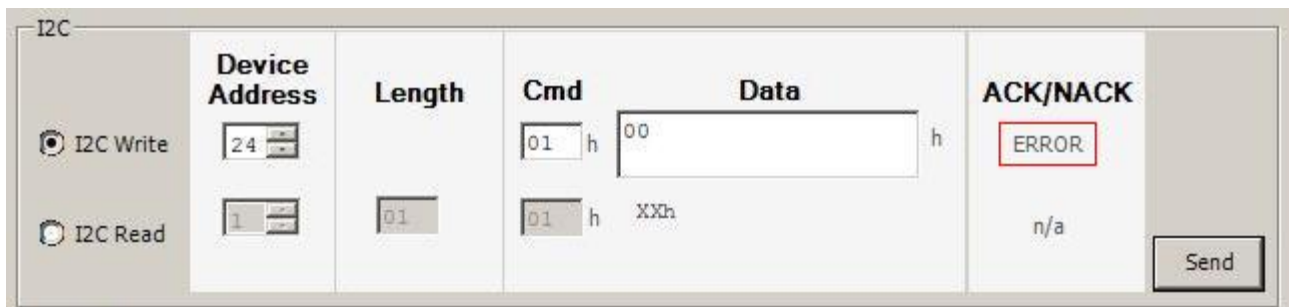

Figure 11. GUI Screen with Failure, After Sending the First Line of Initialization Code

To control the ANY-OUT voltage setting pins of the TPS7A7200EVM-718 at the J5 header, the IO pins (P0 to P5) of the PCA9557 are configured to be either ground or floating using the GUI (see [Figure 1](#)). Also, the level shifter circuit driving EN requires selecting either ground or float. For this selection, an open-drain output is the most preferable output configuration. However, the PCA9557 device does not have open-drain outputs, except for the P0 terminal. To achieve open-drain equivalent effects at the P1 to P6 terminals, the following set of methods is used:

- The ground option can be implemented by using P1 to P6 as output terminals with a logic low setting. The low-side output transistor within the P1 to P6 pins drives these pins to GND. This setting is equivalent to an open-drain terminal in an on-state.
- The float option can be implemented by using P1 to P6 as input terminals. With the PCA9557, P1 to P6 are configurable as inputs or outputs; when used as an input configuration, P1 to P6 become high impedance. This setting is equivalent to an open-drain terminal in high-impedance state.

With this operating strategy, a logic low output is always required when P1 to P6 are selected as outputs. Therefore, data 00h is written to the Output Port Register in the first line of [Table 1](#). With the third line of [Table 1](#), all IO pins are configured as inputs by writing FFh to the Configuration Register; thus, P1 to P6 become high impedance (floating). After the [Table 1](#) initializes, the TPS7A7200 is disabled (EN = L) and the target output voltage becomes 0.5 V (see Table 1 of the [TPS7A7200 data sheet](#)). Afterwards, the Configuration Register bits (Cmd 03h) can be toggled to achieve pseudo open-drain outputs at P1 to P6.

The meaning of the second initialization code is explained later in [Section 4.4](#).

4.3 Operation Code Table

[Table 2](#) describes the entire system operating code. As explained in [Section 4.2](#), changing only the Configuration Register bits results in full system operation. Use the target output voltage value shown in [Table 2](#), send the code (see [Figure 10](#)), and the TPS7A7200 device follows the command. When an entire series of operations finishes, send the first line of [Table 2](#) to disable the TPS7A7200 (this line is the same as the third line of [Table 1](#)).

Table 2. Operation Code Table

DEVICE ADDRESS	LENGTH	CMD	DATA	TARGET OUTPUT VOLTAGE
24	n/a	03h	FFh	(Disable the TPS7A7200)
24	n/a	03h	BFh	0.50 (V)
24	n/a	03h	BEh	0.55 (V)
24	n/a	03h	BDh	0.60 (V)
24	n/a	03h	BCh	0.65 (V)
24	n/a	03h	BBh	0.70 (V)
24	n/a	03h	BAh	0.75 (V)
24	n/a	03h	B9h	0.80 (V)
24	n/a	03h	B8h	0.85 (V)
24	n/a	03h	B7h	0.90 (V)
24	n/a	03h	B6h	0.95 (V)
24	n/a	03h	B5h	1.00 (V)
24	n/a	03h	B4h	1.05 (V)
24	n/a	03h	B3h	1.10 (V)
24	n/a	03h	B2h	1.15 (V)
24	n/a	03h	B1h	1.20 (V)
24	n/a	03h	B0h	1.25 (V)
24	n/a	03h	AFh	1.30 (V)
24	n/a	03h	AEh	1.35 (V)
24	n/a	03h	ADh	1.40 (V)
24	n/a	03h	ACh	1.45 (V)
24	n/a	03h	ABh	1.50 (V)
24	n/a	03h	AAh	1.55 (V)

Table 2. Operation Code Table (continued)

DEVICE ADDRESS	LENGTH	CMD	DATA	TARGET OUTPUT VOLTAGE
24	n/a	03h	A9h	1.60 (V)
24	n/a	03h	A8h	1.65 (V)
24	n/a	03h	A7h	1.70 (V)
24	n/a	03h	A6h	1.75 (V)
24	n/a	03h	A5h	1.80 (V)
24	n/a	03h	A4h	1.85 (V)
24	n/a	03h	A3h	1.90 (V)
24	n/a	03h	A2h	1.95 (V)
24	n/a	03h	A1h	2.00 (V)
24	n/a	03h	A0h	2.05 (V)
24	n/a	03h	9Fh	2.10 (V)
24	n/a	03h	9Eh	2.15 (V)
24	n/a	03h	9Dh	2.20 (V)
24	n/a	03h	9Ch	2.25 (V)
24	n/a	03h	9Bh	2.30 (V)
24	n/a	03h	9Ah	2.35 (V)
24	n/a	03h	99h	2.40 (V)
24	n/a	03h	98h	2.45 (V)
24	n/a	03h	97h	2.50 (V)
24	n/a	03h	96h	2.55 (V)
24	n/a	03h	95h	2.60 (V)
24	n/a	03h	94h	2.65 (V)
24	n/a	03h	93h	2.70 (V)
24	n/a	03h	92h	2.75 (V)
24	n/a	03h	91h	2.80 (V)
24	n/a	03h	90h	2.85 (V)
24	n/a	03h	8Fh	2.90 (V)
24	n/a	03h	8Eh	2.95 (V)
24	n/a	03h	8Dh	3.00 (V)
24	n/a	03h	8Ch	3.05 (V)
24	n/a	03h	8Bh	3.10 (V)
24	n/a	03h	8Ah	3.15 (V)
24	n/a	03h	89h	3.20 (V)
24	n/a	03h	88h	3.25 (V)
24	n/a	03h	87h	3.30 (V)
24	n/a	03h	86h	3.35 (V)
24	n/a	03h	85h	3.40 (V)
24	n/a	03h	84h	3.45 (V)
24	n/a	03h	83h	3.50 (V)
24	n/a	03h	82h	3.55 (V)
24	n/a	03h	81h	3.60 (V)
24	n/a	03h	80h	3.65 (V)

4.4 Reading the PG Pin Status

This system can read the TPS7A7200 PG pin status through P7 of the PCA9557 IO pin. This means that the system supports a complete LDO regulator remote control and monitor.

To monitor the PG status, use the I²C read function of the GUI software by sending the code in [Table 3](#). The read value is displayed under the data column. The 8-bit data MSB shows the PG status. [Figure 12](#) shows the returned data (40h), which means the MSB is PG = L (logic low); this result is captured after sending the disable code (Cmd = 03h and data = FFh). [Figure 13](#) shows the returned data (80h), which means the MSB is PG = H (logic high); this result is captured after sending the enable with 3.3-V output code (Cmd = 03h and data = 87h).

With the second initialization code in [Table 1](#), all input bits are configured to return positive logic.

In the [Figure 12](#) condition, all IO P7 to P0 bits are configured as input ports. At P5 to P0, the PCA9557 device reads digital data bits as all logic low from the 0.5-V analog signal, which is the TPS7A7200 device reference voltage. At P6, a pull-up resistor (R1) gives a logic high. At P7, the TPS7A7200 outputs a not-power-good signal that is logic low. Thus, the resulting read value is 40h.

In the [Figure 13](#) condition, P2 to P0 are configured as input ports and, as previously described, the read values are logic low. P6 to P3 are configured as output ports and have a logic low level, meaning that the reading values are all logic low. At P7, assuming the TPS7A7200 board is working normally, the LDO regulator outputs a power-good signal that is logic high. Thus, the resulting reading value is 80h.

Table 3. PCA9557 Initialization Code

Device Address	Length	Cmd	Data
24	1	00 h	n/a

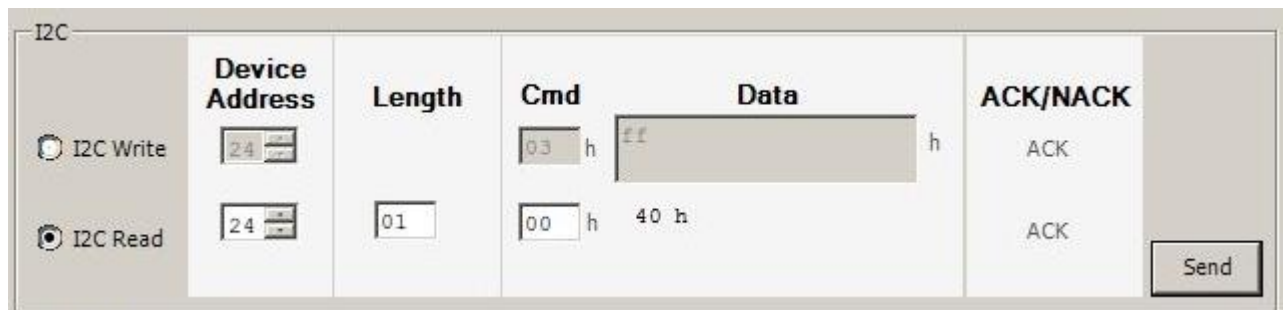

I2C

	Device Address	Length	Cmd	Data	ACK/NACK
<input type="radio"/> I2C Write	24		03 h	ff h	ACK
<input checked="" type="radio"/> I2C Read	24	01	00 h	40 h	ACK

Send

Figure 12. GUI Screen Reading the PG = L Status After Sending Disable Code

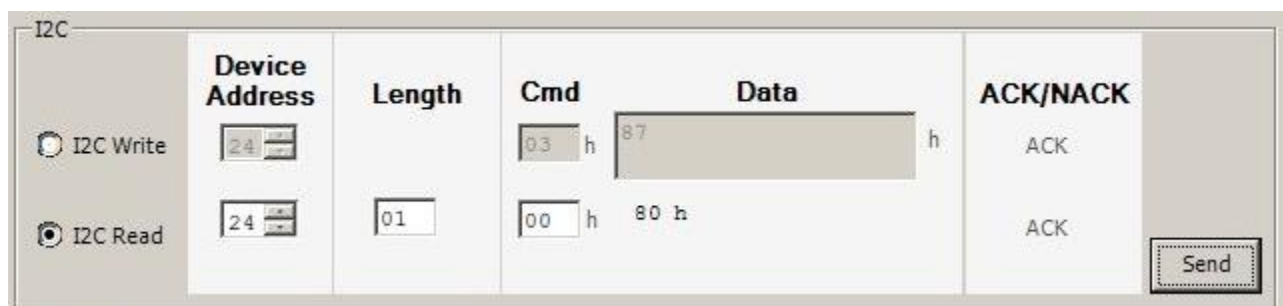

I2C

	Device Address	Length	Cmd	Data	ACK/NACK
<input type="radio"/> I2C Write	24		03 h	87 h	ACK
<input checked="" type="radio"/> I2C Read	24	01	00 h	80 h	ACK

Send

Figure 13. GUI Screen Reading the PG = H Status After Sending Enable (3.3V Output) Code

5 Summary

An ANY-OUT LDO regulator can be controlled by the I²C interface in combination with the I²C IO expander PCA9557 device. The controller monitors the device PG status through the I²C connection, in addition to controlling the LDO regulator. This application report details the capability of an ANY-OUT LDO regulator in digital remote control and monitor demands. Even though ANY-OUT regulators do not support I²C, the example circuit in [Figure 1](#) using the PCA9557 device can upgrade the ANY-OUT LDO regulator to an I²C-compatible solution. Texas Instruments is in the process of releasing more ANY-OUT LDOs; check www.ti.com for the latest releases.

6 Appendix: List of Released ANY-OUT LDO Regulators

- [TPS7A7100: 1-A LDO Regulator](#)
- [TPS7A7200: 2-A LDO Regulator](#)
- [TPS7A7300: 3-A LDO Regulator](#)
- [TPS7A4700: 1-A, Low-Noise, High-PSRR LDO Regulator](#)

IMPORTANT NOTICE

Texas Instruments Incorporated and its subsidiaries (TI) reserve the right to make corrections, enhancements, improvements and other changes to its semiconductor products and services per JESD46, latest issue, and to discontinue any product or service per JESD48, latest issue. Buyers should obtain the latest relevant information before placing orders and should verify that such information is current and complete. All semiconductor products (also referred to herein as "components") are sold subject to TI's terms and conditions of sale supplied at the time of order acknowledgment.

TI warrants performance of its components to the specifications applicable at the time of sale, in accordance with the warranty in TI's terms and conditions of sale of semiconductor products. Testing and other quality control techniques are used to the extent TI deems necessary to support this warranty. Except where mandated by applicable law, testing of all parameters of each component is not necessarily performed.

TI assumes no liability for applications assistance or the design of Buyers' products. Buyers are responsible for their products and applications using TI components. To minimize the risks associated with Buyers' products and applications, Buyers should provide adequate design and operating safeguards.

TI does not warrant or represent that any license, either express or implied, is granted under any patent right, copyright, mask work right, or other intellectual property right relating to any combination, machine, or process in which TI components or services are used. Information published by TI regarding third-party products or services does not constitute a license to use such products or services or a warranty or endorsement thereof. Use of such information may require a license from a third party under the patents or other intellectual property of the third party, or a license from TI under the patents or other intellectual property of TI.

Reproduction of significant portions of TI information in TI data books or data sheets is permissible only if reproduction is without alteration and is accompanied by all associated warranties, conditions, limitations, and notices. TI is not responsible or liable for such altered documentation. Information of third parties may be subject to additional restrictions.

Resale of TI components or services with statements different from or beyond the parameters stated by TI for that component or service voids all express and any implied warranties for the associated TI component or service and is an unfair and deceptive business practice. TI is not responsible or liable for any such statements.

Buyer acknowledges and agrees that it is solely responsible for compliance with all legal, regulatory and safety-related requirements concerning its products, and any use of TI components in its applications, notwithstanding any applications-related information or support that may be provided by TI. Buyer represents and agrees that it has all the necessary expertise to create and implement safeguards which anticipate dangerous consequences of failures, monitor failures and their consequences, lessen the likelihood of failures that might cause harm and take appropriate remedial actions. Buyer will fully indemnify TI and its representatives against any damages arising out of the use of any TI components in safety-critical applications.

In some cases, TI components may be promoted specifically to facilitate safety-related applications. With such components, TI's goal is to help enable customers to design and create their own end-product solutions that meet applicable functional safety standards and requirements. Nonetheless, such components are subject to these terms.

No TI components are authorized for use in FDA Class III (or similar life-critical medical equipment) unless authorized officers of the parties have executed a special agreement specifically governing such use.

Only those TI components which TI has specifically designated as military grade or "enhanced plastic" are designed and intended for use in military/aerospace applications or environments. Buyer acknowledges and agrees that any military or aerospace use of TI components which have **not** been so designated is solely at the Buyer's risk, and that Buyer is solely responsible for compliance with all legal and regulatory requirements in connection with such use.

TI has specifically designated certain components which meet ISO/TS16949 requirements, mainly for automotive use. Components which have not been so designated are neither designed nor intended for automotive use; and TI will not be responsible for any failure of such components to meet such requirements.

Products

Audio	www.ti.com/audio
Amplifiers	amplifier.ti.com
Data Converters	dataconverter.ti.com
DLP® Products	www.dlp.com
DSP	dsp.ti.com
Clocks and Timers	www.ti.com/clocks
Interface	interface.ti.com
Logic	logic.ti.com
Power Mgmt	power.ti.com
Microcontrollers	microcontroller.ti.com
RFID	www.ti-rfid.com
OMAP Applications Processors	www.ti.com/omap
Wireless Connectivity	www.ti.com/wirelessconnectivity

Applications

Automotive and Transportation	www.ti.com/automotive
Communications and Telecom	www.ti.com/communications
Computers and Peripherals	www.ti.com/computers
Consumer Electronics	www.ti.com/consumer-apps
Energy and Lighting	www.ti.com/energy
Industrial	www.ti.com/industrial
Medical	www.ti.com/medical
Security	www.ti.com/security
Space, Avionics and Defense	www.ti.com/space-avionics-defense
Video and Imaging	www.ti.com/video

TI E2E Community

e2e.ti.com