

TRF7970A NFC Reader Antenna Multiplexing

Kostas Aslanidis and Vishwash Needhan Gunasegaran

ABSTRACT

This application report describes the implementation of multiple reader antennas with a single [TRF7970A NFC transceiver IC](#). For demonstration purposes, the [MSP430F5529 LaunchPad™ development kit](#) with [TRF7970A BoosterPack™ plug-in module](#) are used. The [PE42359 UltraCMOS® RF Switch](#) from [Peregrine Semiconductors](#) is used for switching due to its simple control methodology and low power loss during switching. The demo supports ISO/IEC 15693, ISO/IEC 14443A, and ISO/IEC 14443B communication protocols.

This application report describes a simple demo of antenna multiplexing that can help when using the TRF7970A in applications with multiple antennas. This application report is an addition to the advanced demo for multiplexing 16 antennas that is described in *TRF7960A RFID Multiplexer Example System (SLOA167)*. This application report uses an alternative switching device and an easier control strategy. The control algorithm can be easily written and added to the existing firmware.

The NFC firmware code used for this application can be downloaded from the [TI website](#). Further information about the installation and setup of the GUI and the devices can be found in the [design guide](#) for the [Near Field Communication \(NFC\) Reader/Writer Reference Design](#).

Contents

1	Theory of Operation	2
2	Hardware Information	2
3	Control Methodology	4
4	Software Information	5
5	Performance Analysis	6
6	References	8

List of Figures

1	Block Diagram of Reader Antenna Multiplexing Demo	2
2	MSP430F5529 LaunchPad Development Kit	3
3	TRF7970A BP Modifications	3
4	PE42359 RF Switch Pin Configuration and Description	4
5	Single-Pin Control Method.....	4
6	Complementary-Pin Control Method	5
7	Insertion of Control Algorithm	6
8	Output Power Comparison of TRF7970ABP With and Without PE42359	7
9	Prototype of TRF7970ABP + PE42359 RF Switch Demonstration	7
10	NFC Tool GUI in Reader/Writer Mode	8

LaunchPad, BoosterPack, Code Composer Studio are trademarks of Texas Instruments.
 UltraCMOS is a registered trademark of Peregrine Semiconductors.
 All other trademarks are the property of their respective owners.

1 Theory of Operation

NOTE: In this document, *MSP430F5529LP* is used to refer to the MSP430F5529 USB LaunchPad development kit ([MSP-EXP430F5529LP](#)), and *TRF7970ABP* is used to refer to the TRF7970A NFC Transceiver BoosterPack plug-in module ([DLP-7970ABP](#)).

Antenna multiplexing is the concept of switching between multiple antennas connected to a single TRF7970A NFC transceiver IC. To multiplex antennas, it is necessary to switch between the antennas and to identify the antenna used. To keep the complexity of the design low, a low power loss switch with simple control methods has been used.

The block diagram in [Figure 1](#) shows the working concept of the demo. From a host PC, the TI NFC v1.7 GUI is used. The MSP430F5529LP has two onboard buttons (S1 and S2). The antennas are switched by pressing button S1 (Port 2.1) or S2 (Port 1.1). The PE42359 acts as a relay to switch between antennas. By default and when button S1 is pressed, antenna 1 is turned ON and antenna 2 is turned OFF. When button S2 is pressed, antenna 2 is turned ON and antenna 1 is turned OFF.

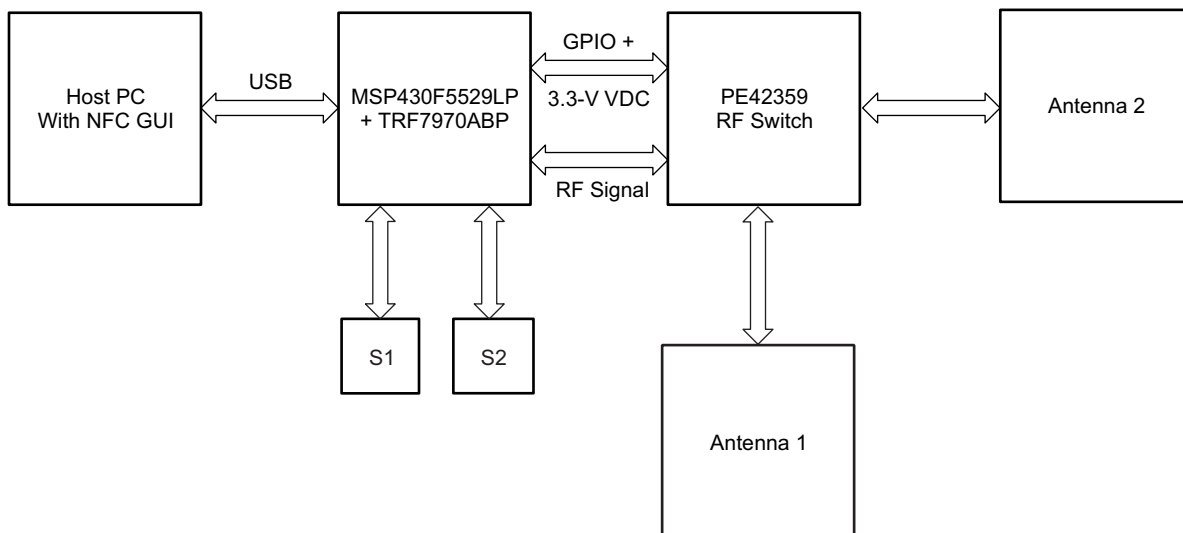

Figure 1. Block Diagram of Reader Antenna Multiplexing Demo

2 Hardware Information

The MSP430F5529LP includes an easy-to-use microcontroller. The onboard buttons and the LEDs can be freely defined and used as required. One advantage of this development kit is the 40-pin access headers with both 5.0-VDC and 3.3-VDC supplies. These headers can be used to add a wide range of BoosterPack plug-in modules. One such module is the TRF7970ABP.

The MSP430F5529LP must be connected to the host PC through USB. After the setup is complete, run the GUI (see [Figure 10](#)). The kit can automatically connect to the GUI on the host PC when you select the hardware device. For instructions on how to connect the kit and to get familiar with the GUI, see the [TIDM-NFC-RW Design Guide](#). By activating the READ/WRITE mode, the MSP430F5529LP + TRF7970ABP starts to establish a NFC/RFID communication with the transponders. [Figure 2](#) shows the MSP430F5529LP.

The TRF7970ABP uses the 3.3-V supply voltage. The 5.0-VDC pins are free and can be used for the application. The TRF7970ABP extends the MSP430F5529LP functionality with a NFC/RFID wireless communication interface.

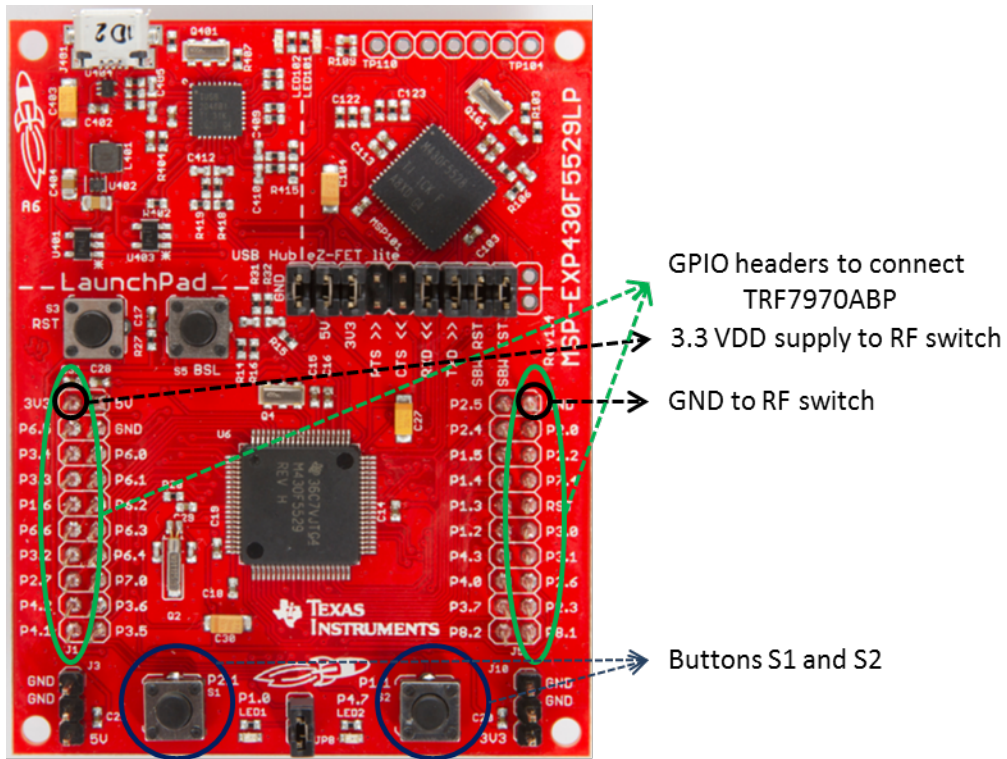

Figure 2. MSP430F5529 LaunchPad Development Kit

Figure 3 shows the TRF7970ABP modifications to add an SMA antenna connector for an external antenna. After this modification, the onboard antenna is disabled.

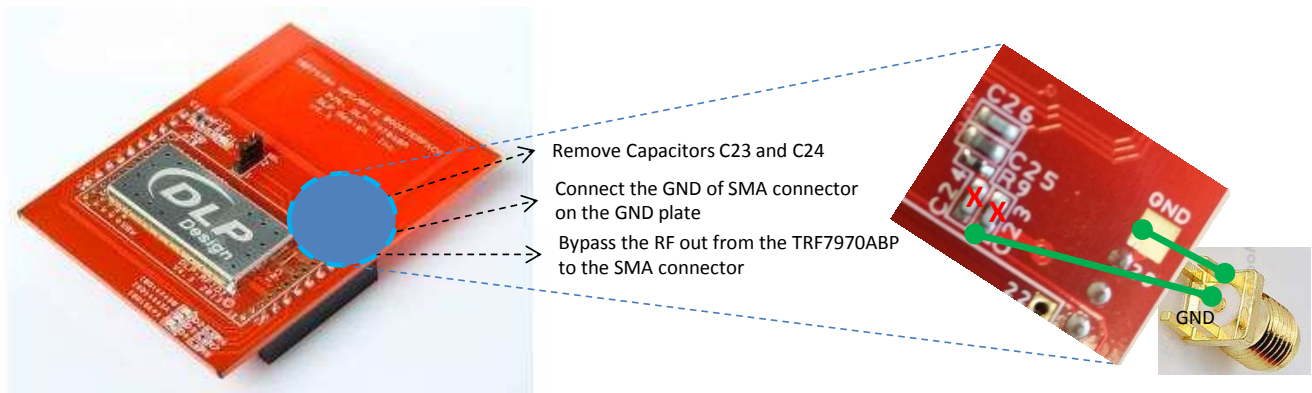
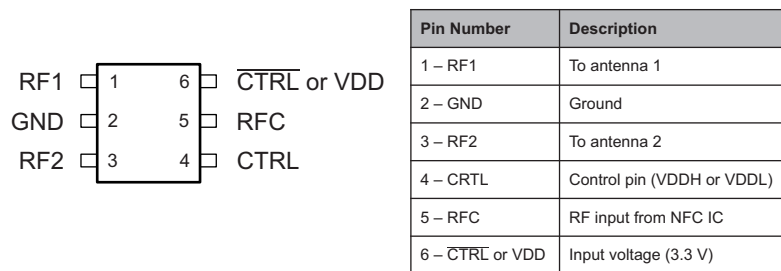

Figure 3. TRF7970A BP Modifications

Switching between antennas is performed through the PE42359 UltraCMOS RF switch from Peregrine Semiconductors. The PE42359 supports a broad range of frequencies from 10 MHz to 3 GHz. The RF switch is a 6-pin SC-70 package. Figure 4 shows the RF switch construction.

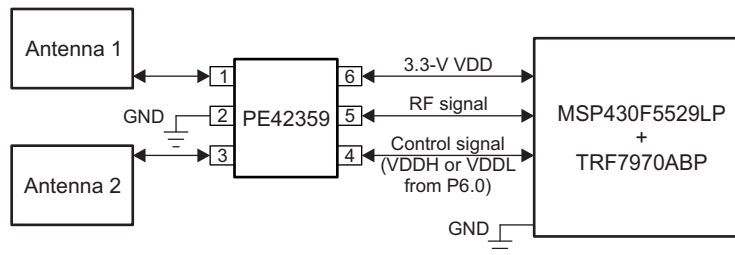

Figure 4. PE42359 RF Switch Pin Configuration and Description

3 Control Methodology

There are two modes of control methodology: single-pin control or complementary-pin control. The single-pin control method is the simplest way to control the switching process.

The antenna switch is supplied with a constant 3.3-V input to VDD (pin 6). The CTRL pin (pin 4) is connected to a GPIO pin of the MSP430F5529LP. Two control signal levels are generated in the MSP430F5529 GPIO pin. The signals are VDDH (VDD high signal, which is higher than 70% of 3.3 V) and VDDL (VDD low signal, which is lower than 30% of 3.3 V).

When VDDH is applied to the CTRL pin (pin 4), antenna 1 is turned ON and antenna 2 is turned OFF. When VDDL is applied to the CTRL pin (pin 4), antenna 2 is turned ON and antenna 1 is turned OFF. The signal levels VDDH and VDDL are generated by turning the GPIO pin on or off, respectively, in the MSP430F5529. [Figure 5](#) shows the single-pin control method.



NOTE: 3.3 VDC is supplied to VDD pin.

Figure 5. Single-Pin Control Method

In this example, the GPIO pin P6.0 on the MSP430F5529LP is connected to the CTRL pin in the RF switch. The pins 3.3VDC and GND on the MSP430F5529LP (see [Figure 5](#)) are connected to VDD (pin 6) and ground (pin 2), respectively, on the RF switch.

The complementary-pin control method requires careful planning of GPIO pin allocations. It does not require a constant VDD supply; instead an inverted signal of the control signal is fed to VDD. If the CTRL pin is supplied with the VDDH signal, then the VDD pin is kept low and antenna 1 is turned ON. If the CTRL pin is supplied with VDDL, VDD is kept high (3.3 V), and antenna 2 is turned ON. The VDD and CTRL pins cannot be high or low simultaneously. [Figure 6](#) shows the complementary-pin control method.

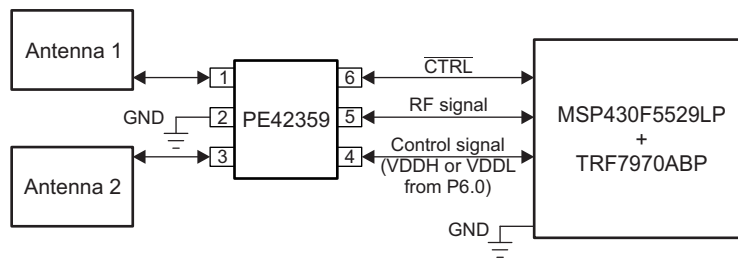

NOTE: The inverse signal of CTRL is supplied to pin 6.

Figure 6. Complementary-Pin Control Method

4 Software Information

In this example, the single-pin control mode method controls the switching of antennas. The reason for choosing this control method is the possibility for simple pin allocations. The following control algorithm has been written and added to the microcontroller firmware:

```

P6DIR |= (BIT0);           //Port 6.0 as output
P2DIR &= ~(BIT1);        //P2.1 as input
P1DIR &= ~(BIT1);        //P1.1 as input

if(~P2IN&BIT1)           //switch p2.1
{
    P6OUT |= BIT0;
}
if(~P1IN&BIT1)           //switch p1.1
{
    P6OUT &= ~BIT0;
}
    
```

The concept of the code is:

- **IF** Port 6.0 == ON **THEN** Antenna 1 == ON and Antenna 2 == OFF
- **IF** Port 6.0 == OFF **THEN** Antenna 1 == OFF and Antenna 2 == ON

```

270 T3T_init(g_ui8TxBuffer,256);
271 T4T_init(g_ui8TxBuffer,256);
272 T5T_init(g_ui8TxBuffer,256);
273
274 while(1)
275 {
276     eTempNFCState = NFC_run();
277
278     //Switching
279
280     P6DIR |= (BIT0);           // Port 6.1 as output
281     P2DIR &= ~(BIT1);        //P2.1 as input
282     P1DIR &= ~(BIT1);        //P1.1 as input
283
284     if(~P2IN&BIT1)           //switch p2.1 ----> Switch S1, onboard MSP430F5529LP
285     {
286         P6OUT |= BIT0;
287     }
288
289     if(~P1IN&BIT1)           //switch p1.1 ----> Switch S2, onboard MSP430F5529LP
290     {
291         P6OUT &= ~BIT0;
292     }
293
294
295
296
297     if(eTempNFCState == NFC_DATA_EXCHANGE_PROTOCOL)
298     {
299         if(NFC_RW_getModeStatus(&sRWMode,&sRWBitrate))
300         {
301             NFC_RW_LED_POUT |= NFC_RW_LED_BIT;
302
303             if( sRWMode.bits.bnfcA == 1)
304             {
305                 if(NFC_A_getSAK() == 0x00)
    
```

Figure 7. Insertion of Control Algorithm

The short algorithm explained is added to the program main.c between the lines 278 and 295. Code Composer Studio™ IDE v6.1 or higher is required to edit the firmware. After the installation of the [example files](#), the example project can be found in the host PC in the folder C:\ti\msp430\TRF7970A_RW_1.02.05\examples\boards\MSP-EXP430F5529LP\F5529LP_TRF7970A_ALL_NFC_MODES.

5 Performance Analysis

The multiplexing of antennas application requires minimum signal losses. It is important to keep the RF signal losses to a minimum to avoid degradation of performance. To test the performance of the demo, several tests were executed, and the most important results are discussed here.

The performance of the PE42359 RF switch is tested. Three modes of operation were tested

- Mode 1: TRF7970ABP without PE42359 RF switch (one antenna only)
- Mode 2: TRF7970ABP with PE42359 RF switch (with VDD supply, single-pin control mode)
- Mode 3: TRF7970ABP with PE42359 RF switch (without VDD supply, complimentary-pin control mode)

The performance analysis related to field strength over distance measurements (see Figure 8) shows that the PE42359 RF switch works with negligible power loss.

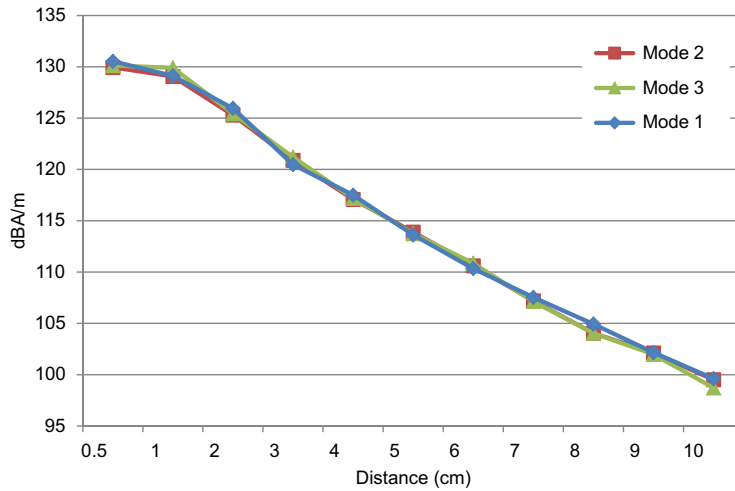

Figure 8. Output Power Comparison of TRF7970ABP With and Without PE42359

The influence of the RF switch and different control methods was analyzed. Figure 9 shows the demo.

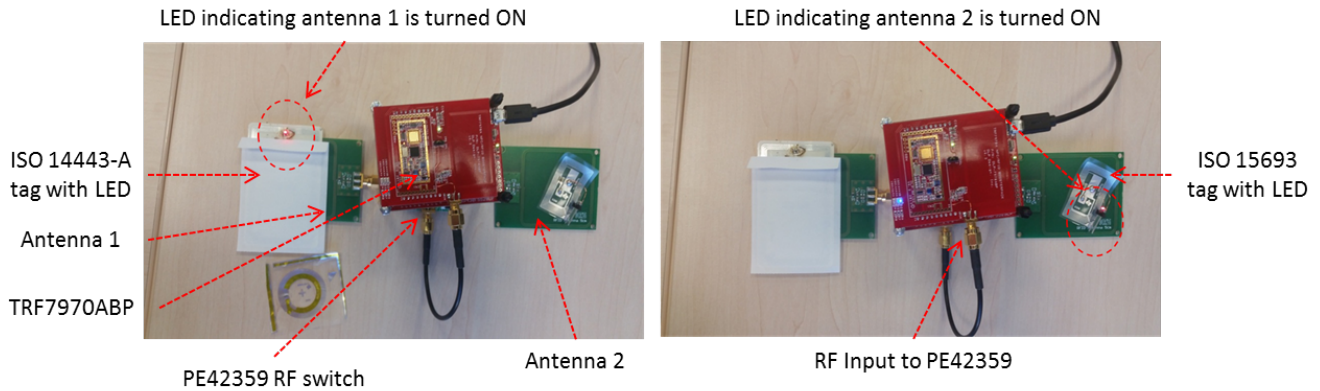

Figure 9. Prototype of TRF7970ABP + PE42359 RF Switch Demonstration

One advantage of using the GUI (see [Figure 10](#)) is that the received signal strength indication (RSSI) is available. RSSI is the measure of the power present in the received radio signal. Information about the type of card, bit rate, and the UID is also available in the GUI.

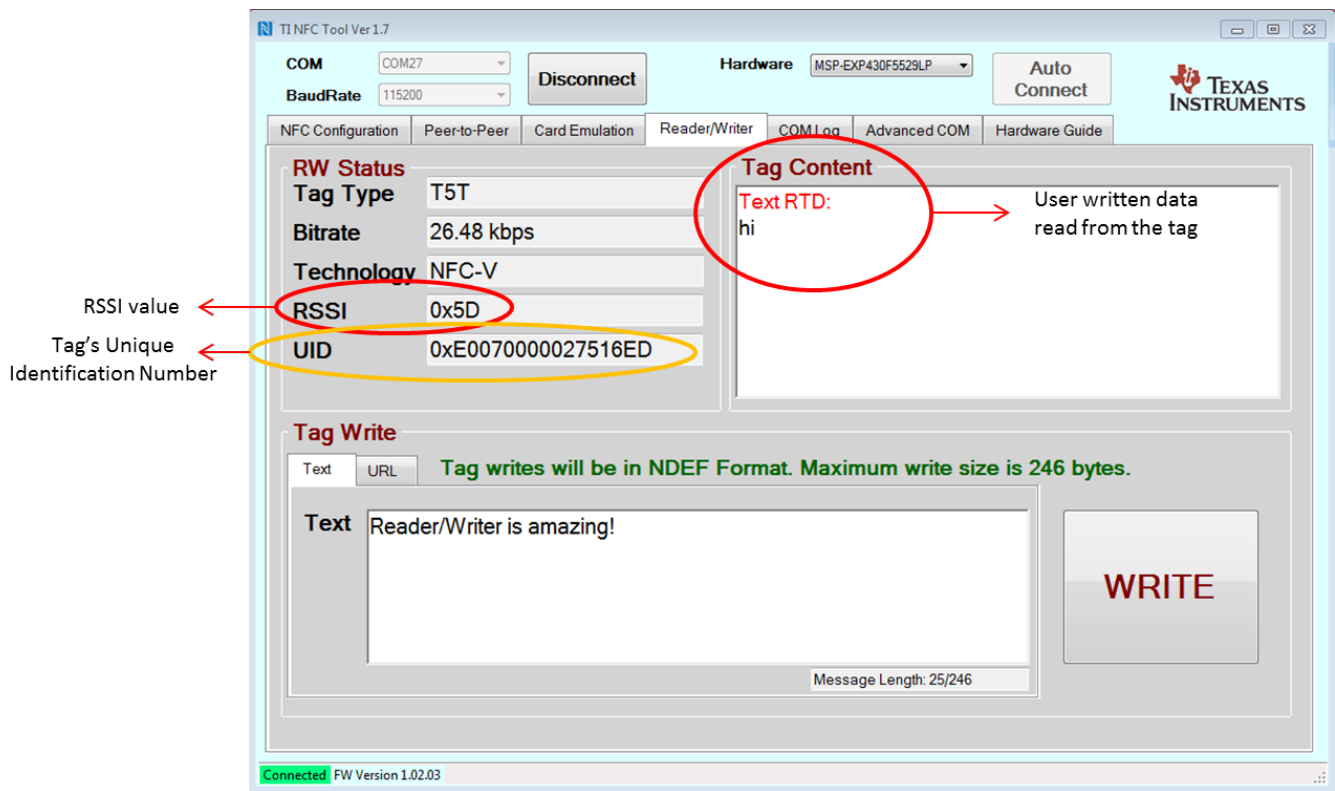

Figure 10. NFC Tool GUI in Reader/Writer Mode

6 References

1. [MSP430F5529 LaunchPad Development Kit \(MSP-EXP430F5529LP\) User's Guide](#)
2. [TRF7970A Multi-Protocol Fully Integrated 13.56-MHz RFID and NFC Transceiver IC](#)
3. [NFC/HF RFID Reader/Writer Using the TRF7970A](#)
4. [PE42359 SPDT UltraCMOS® RF Switch 10 MHz – 3 GHz](#)
5. [TRF7960A RFID Multiplexer Example System](#)
6. [TIDM-NFC-RW Design Guide](#)

IMPORTANT NOTICE

Texas Instruments Incorporated and its subsidiaries (TI) reserve the right to make corrections, enhancements, improvements and other changes to its semiconductor products and services per JESD46, latest issue, and to discontinue any product or service per JESD48, latest issue. Buyers should obtain the latest relevant information before placing orders and should verify that such information is current and complete. All semiconductor products (also referred to herein as "components") are sold subject to TI's terms and conditions of sale supplied at the time of order acknowledgment.

TI warrants performance of its components to the specifications applicable at the time of sale, in accordance with the warranty in TI's terms and conditions of sale of semiconductor products. Testing and other quality control techniques are used to the extent TI deems necessary to support this warranty. Except where mandated by applicable law, testing of all parameters of each component is not necessarily performed.

TI assumes no liability for applications assistance or the design of Buyers' products. Buyers are responsible for their products and applications using TI components. To minimize the risks associated with Buyers' products and applications, Buyers should provide adequate design and operating safeguards.

TI does not warrant or represent that any license, either express or implied, is granted under any patent right, copyright, mask work right, or other intellectual property right relating to any combination, machine, or process in which TI components or services are used. Information published by TI regarding third-party products or services does not constitute a license to use such products or services or a warranty or endorsement thereof. Use of such information may require a license from a third party under the patents or other intellectual property of the third party, or a license from TI under the patents or other intellectual property of TI.

Reproduction of significant portions of TI information in TI data books or data sheets is permissible only if reproduction is without alteration and is accompanied by all associated warranties, conditions, limitations, and notices. TI is not responsible or liable for such altered documentation. Information of third parties may be subject to additional restrictions.

Resale of TI components or services with statements different from or beyond the parameters stated by TI for that component or service voids all express and any implied warranties for the associated TI component or service and is an unfair and deceptive business practice. TI is not responsible or liable for any such statements.

Buyer acknowledges and agrees that it is solely responsible for compliance with all legal, regulatory and safety-related requirements concerning its products, and any use of TI components in its applications, notwithstanding any applications-related information or support that may be provided by TI. Buyer represents and agrees that it has all the necessary expertise to create and implement safeguards which anticipate dangerous consequences of failures, monitor failures and their consequences, lessen the likelihood of failures that might cause harm and take appropriate remedial actions. Buyer will fully indemnify TI and its representatives against any damages arising out of the use of any TI components in safety-critical applications.

In some cases, TI components may be promoted specifically to facilitate safety-related applications. With such components, TI's goal is to help enable customers to design and create their own end-product solutions that meet applicable functional safety standards and requirements. Nonetheless, such components are subject to these terms.

No TI components are authorized for use in FDA Class III (or similar life-critical medical equipment) unless authorized officers of the parties have executed a special agreement specifically governing such use.

Only those TI components which TI has specifically designated as military grade or "enhanced plastic" are designed and intended for use in military/aerospace applications or environments. Buyer acknowledges and agrees that any military or aerospace use of TI components which have **not** been so designated is solely at the Buyer's risk, and that Buyer is solely responsible for compliance with all legal and regulatory requirements in connection with such use.

TI has specifically designated certain components as meeting ISO/TS16949 requirements, mainly for automotive use. In any case of use of non-designated products, TI will not be responsible for any failure to meet ISO/TS16949.

Products

Audio	www.ti.com/audio
Amplifiers	amplifier.ti.com
Data Converters	dataconverter.ti.com
DLP® Products	www.dlp.com
DSP	dsp.ti.com
Clocks and Timers	www.ti.com/clocks
Interface	interface.ti.com
Logic	logic.ti.com
Power Mgmt	power.ti.com
Microcontrollers	microcontroller.ti.com
RFID	www.ti-rfid.com
OMAP Applications Processors	www.ti.com/omap
Wireless Connectivity	www.ti.com/wirelessconnectivity

Applications

Automotive and Transportation	www.ti.com/automotive
Communications and Telecom	www.ti.com/communications
Computers and Peripherals	www.ti.com/computers
Consumer Electronics	www.ti.com/consumer-apps
Energy and Lighting	www.ti.com/energy
Industrial	www.ti.com/industrial
Medical	www.ti.com/medical
Security	www.ti.com/security
Space, Avionics and Defense	www.ti.com/space-avionics-defense
Video and Imaging	www.ti.com/video

TI E2E Community

e2e.ti.com