

Convert UCC28064A EVM to Higher Switching Frequency Using UCC28065

ABSTRACT

Interleaved transition mode PFC is a popular topology in many applications due to its high efficiency and smaller EMI filter size. To improve the power density of the design, reducing the Boost inductor height, designers need to increase the switching frequency. The new generation interleaved transition mode PFC controller, UCC28065, doubles the switching frequency capability compared with its previous generation devices and makes it a more suitable device for high-frequency designs. In this application note, the main differences between the UCC28065 and UCC28064A devices are discussed in detail. A summary of how to convert the UCC28064A EVM to evaluate the UCC28065 device is presented.

Contents

1	Introduction	2
2	TM PFC Operating With Higher Switching Frequency.....	2
3	UCC28065 Changes	6
4	Modifying UCC28064A EVM to UCC28065	6
5	Summary.....	9
6	References	9

List of Figures

1	Transition Mode PFC Diagram.....	2
2	TM PFC Key Waveforms	2
3	Theoretical Switching Frequencies of TM PFC for Different Line Voltages.....	3
4	TM PFC Operates in Frequency Clamp	4
5	Minimum Period of UCC28064A for Different TSET Resistor Values	4
6	Zero Crossing Compensation Time (T_{ZCC}) of UCC28064A.....	5
7	Minimum Period Comparison Between UCC28064A and UCC28065.....	6
8	Input Current of UCC28064A EVM, $V_{IN} = 115 \text{ VAC}$, $P_{OUT} = 300 \text{ W}$	6
9	Input Current of UCC28064A EVM (UCC28064EVM-004) With Controller Replaced by UCC28065, $V_{IN} = 115 \text{ VAC}$, $P_{OUT} = 300 \text{ W}$	6
10	UCC28064A EVM (UCC28064EVM_004) Schematic	7
11	Boost Inductor Comparison	8
12	UCC28065 Efficiency at Different Line and Load Conditions	9
13	UCC28065 Power Factor at Different Line and Load Conditions	9

List of Tables

1	Summary of Differences Between UCC28064A and UCC28065	6
2	Component Changes on UCC28064EVM-004 for UCC28065 Evaluation	8
3	Boost Inductor Comparison	8

Trademarks

All trademarks are the property of their respective owners.

1 Introduction

The interleaved transition mode (TM) Power Factor Correction (PFC) has been implemented in different applications, including digital TVs, personal computers, and many other applications. This topology allows power supply designers to use the transition mode PFC to a higher power level, while maintaining a similar input current ripple as a continuous conduction mode (CCM) PFC. This provides the benefits of higher efficiency, ease of low profile design, lower system cost, as well as better thermal design. During recent years, TI has released a family of interleaved TM PFC controllers including [UCC28060](#), [UCC28061](#), [UCC28063A](#), and [UCC28064A](#). This series of devices address different aspects of the design, for better THD, lower audible noise, or better light load efficiency.

Other than these performance improvements, the recent design trend is to achieve a higher power density or further reduction on the converter profile (height). To achieve this, the most straightforward method is to operate the PFC at a higher switching frequency. This allows the converter to use a lower value Boost inductor, which means a smaller inductor size, lower overall profile, or both.

A new generation device, the UCC28065, is introduced to enable doubling or tripling the switching frequency of the current design. This helps to reduce the inductor size, improve the design profile and power density, while maintaining high efficiency and high power factor performance. In this paper, the differences between the UCC28065 device and its previous generation device UCC28064A are discussed in detail. This application note also shows a simple method to convert the UCC28064A EVM ([UCC28064EVM_004](#)) to a higher switching frequency design using the UCC28065 device.

2 TM PFC Operating With Higher Switching Frequency

The TM PFC operates in the transition mode (boundary of discontinuous conduction mode and continuous conduction mode) to eliminate the PFC diode reverse recovery issue. This allows the use of lower cost PFC diodes, reducing the system cost and improving EMI.

2.1 TM PFC Operation Principle

Ideally, in each switching cycle, the TM PFC inductor current starts from zero. When the Boost switch turns on, the inductor current rises linearly with the rate determined by the input voltage and inductor value. After the Boost switch turns off, the inductor current reduces linearly, with the rate determined by the difference between the input and output voltage, and the inductor value. Given the inductor current is a perfect triangle, its average value is half of its peak value.

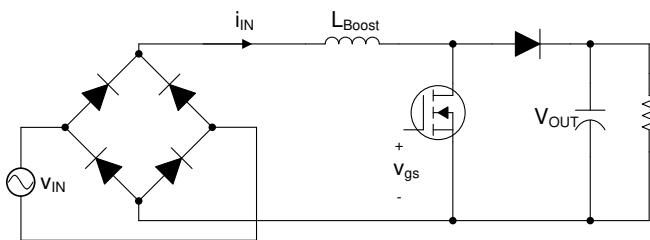

Figure 1. Transition Mode PFC Diagram

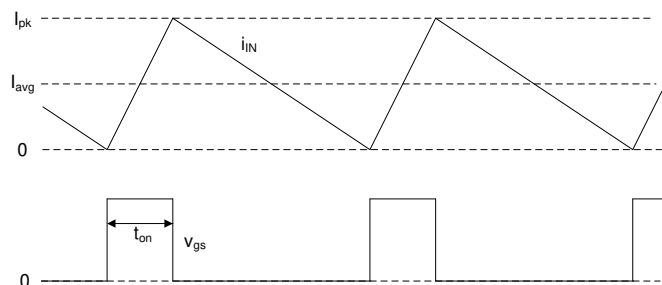

Figure 2. TM PFC Key Waveforms

According to [Equation 1](#), if the on time is kept constant along a line cycle (constant on-time control), the average inductor current is proportional to the input voltage and perfect PFC can be achieved.

$$I_{avg} = \frac{1}{2} I_{pk} = \frac{1}{2} \frac{V_{IN}}{L_{Boost}} t_{on} \tag{1}$$

2.2 Switching Frequency Clamping

Due to the transition mode operation, the switching frequency of the PFC is not a fixed value. It changes with the input voltage and output load. Generally, the switching frequency is higher when the load becomes lighter or the input voltage becomes higher. As [Figure 3](#) shows, the theoretical derived switching frequency changes with different line voltages.

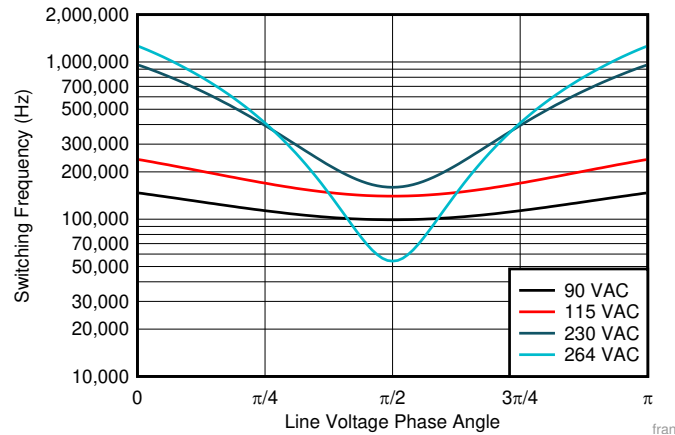

Figure 3. Theoretical Switching Frequencies of TM PFC for Different Line Voltages

It can be seen that the switching frequency gets much higher when the line voltage is zero crossing, compared with the switching frequency at the peak of the line. Also, the switching frequency becomes much higher at lighter loads, compared with the switching frequency at heavier loads at the same line voltage due to the smaller inductor current.

To prevent the excessive switching frequency, which could result in excessive switching loss, the UCC28064A implements a maximum switching frequency clamping, or a minimum switching period clamping. The controller monitors the switching frequency of the Boost switch, when the ZCD signal arrives before the minimum period expires, the ZCD signal is ignored and the controller waits for the next ZCD signal after the minimum period expires. The operation of this frequency clamping is illustrated in [Figure 4](#).

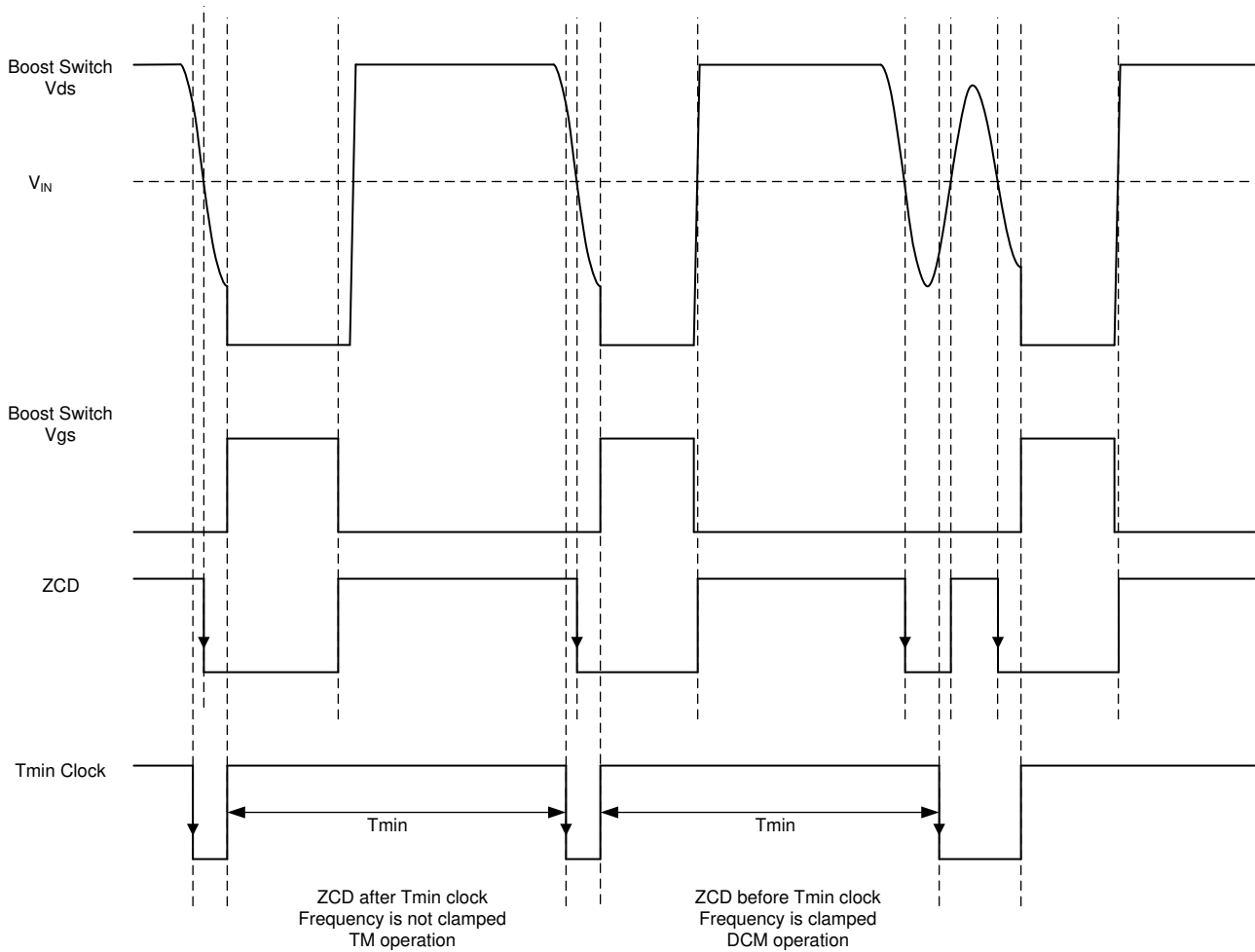

Figure 4. TM PFC Operates in Frequency Clamp

The minimum period of UCC28064A is defined as Equation 2 and is illustrated in Figure 5.

$$T_{min} = \frac{16C_t V_t}{5 \left(I_2 - \frac{1}{8} \frac{V_{TSET}}{R_{TSET}} \right)} \tag{2}$$

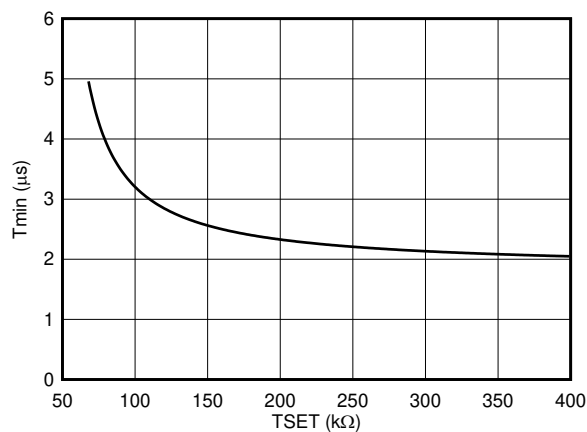

Figure 5. Minimum Period of UCC28064A for Different TSET Resistor Values

In this equation, V_{TSET} is 2.63 V, C_i is 1.0087 pF, I_2 is 7.66 μ A, and V_i is 4.34 V (These are IC internal parameters). Based on this equation, for the largest recommended TSET pin resistor value of 400 k Ω , the minimum period is 2.05 μ s, which is equivalent to a switching frequency of about 500 kHz.

For a traditional design with UCC28064A or earlier generation devices, the minimum switching frequency is typically around 50 kHz. This frequency is reached at the peak of the line cycle at the lowest AC input voltage and full load. With such a low switching frequency design, the frequency clamping is always above the maximum switching frequency the converter demands.

With the demand of higher power density and lower profile, the switching frequency needs to be higher so that the PFC inductor size can be reduced. Equation 3 shows the relationship between the Boost inductor value and switching frequency. Because the input, output voltage, and the load are the design targets, while the inductor current and the RMS current remain the same regardless of the switching frequency, the Boost inductor size is purely determined by the switching frequency selection. To significantly shrink the inductor size, the switching frequency needs to be significantly increased. Therefore, the frequency clamp of the UCC28064A device also needs to be increased to meet the high-frequency design requirement.

$$L_{Boost} = \frac{V_{IN}^2 (V_{OUT} - \sqrt{2}V_{IN})}{\frac{P_{OUT}}{\eta} V_{OUT} f_{SW}} \tag{3}$$

2.3 Zero Crossing Compensation

As discussed earlier, the constant on-time control gives perfect PFC, if the inductor current starts from and returns to zero in each switch cycle. In reality, due to the Boost switch parasitic capacitor, the inductor current flows negatively in each switching cycle to achieve valley switching. This negative current adds an offset to the average current and causes zero crossing distortion. Often this is observed as a flat current duration at the zero crossing. To compensate the zero crossing distortion and improve the input current THD performance, the zero crossing compensation (ZCC) is implemented in the UCC28064A and its earlier generations. The principle is to increase the Boost switch on time, when the line voltage is zero crossing, to compensate the offset caused by the negative current. Since the negative current becomes much less a problem when the input voltage instantaneous value is higher, the compensation is only implemented at the input line voltage zero crossing. The extra on time is shown in the data sheet typical characteristic curves. The T_{ZCC} of UCC28064A at different TSET resistor values are shown in Figure 6.

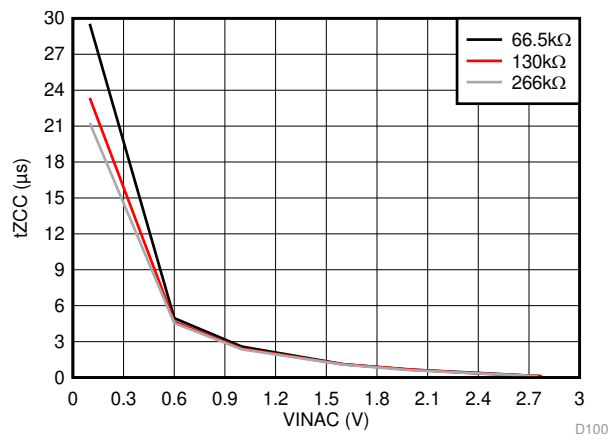

Figure 6. Zero Crossing Compensation Time (T_{zcc}) of UCC28064A

This set of curves shows that the extra on time increases significantly when the input voltage zero crossing (VINAC pin voltage approaching zero). Also, the extra on time is almost identical for different TSET resistor values, which means the extra on time is not adjusted according to the switching frequency. This set of curves works well when the design operates at relatively low switching frequency designs. When the designed switching frequency becomes higher, the inductor value is much smaller. Therefore, the extra on time could cause a lot higher compensation current. The effectiveness of the compensation based on this set of curves begins to deteriorate.

3 UCC28065 Changes

To enable the higher switching frequency designs, the frequency clamp and the zero crossing compensation are modified in the UCC28065 device. This allows the UCC28065 device to become a dedicated device targeting higher switching frequency interleaved TM PFC design. The differences between these two devices are summarized in [Table 1](#).

Table 1. Summary of Differences Between UCC28064A and UCC28065

	Frequency Clamping (Minimum Period)	Zero Crossing Compensation
UCC28064A	$T_{min} = \frac{16C_t V_t}{5 \left(I_2 - \frac{1}{8} \frac{V_{TSET}}{R_{TSET}} \right)}$	Yes
UCC28065	$T_{min} = \frac{8C_t V_t}{5 \left(I_2 - \frac{1}{8} \frac{V_{TSET}}{R_{TSET}} \right)}$	No

From this table, the UCC28065 removes the zero crossing compensation. This allows UCC28065 to operate with much higher switching frequency without worrying about over-compensating the zero crossing distortion. Despite the additional zero crossing distortion that is added by eliminating this compensation, the PFC performance still meets most power factor and harmonic standards.

Other than the zero crossing compensation, the UCC28065 device has half of the minimum period as the UCC28064A device, which means the UCC28065 doubles the clamping frequency compared with the UCC28064A. Theoretically, this doubles the switching frequency of the UCC28064A. However, given current design is not fully utilizing the full switching frequency capability of the UCC28064A, the UCC28065 would allow 2 to 3 times of the switching frequency increasing compared with current designs. Based on the IC characterization data, the maximum frequency clamp that can be achieved, considering the process and temperature variations, is 800 kHz. The comparison of the minimum period for UCC28064A and UCC28065 is shown in [Figure 7](#)

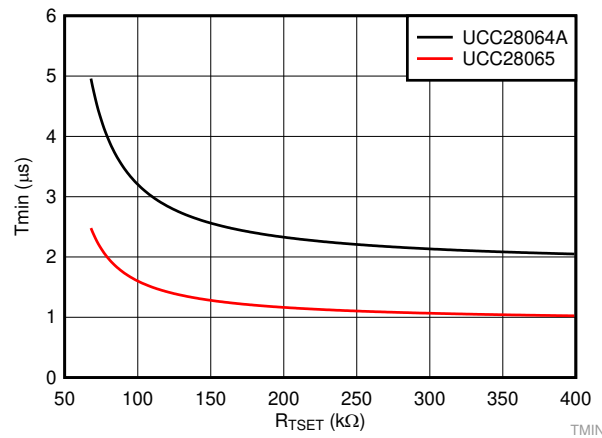

Figure 7. Minimum Period Comparison Between UCC28064A and UCC28065

4 Modifying UCC28064A EVM to UCC28065

The UCC28065 is pin-to-pin compatible with the UCC28064A device. The UCC28065 is drop in compatible with any UCC28064A design, such as the UCC28064A EVM [UCC28064EVM-004](#). The only difference observed is the zero crossing distortion. The measured input current waveforms using the UCC28064A EVM and the same board when replacing the UCC28064A with the UCC28065 are shown in [Figure 8](#) and [Figure 9](#).

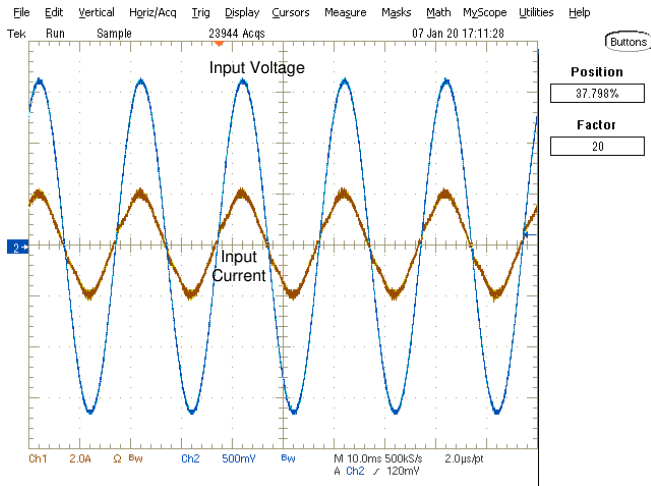

Figure 8. Input Current of UCC28064A EVM, $V_{IN} = 115$ VAC, $P_{OUT} = 300$ W

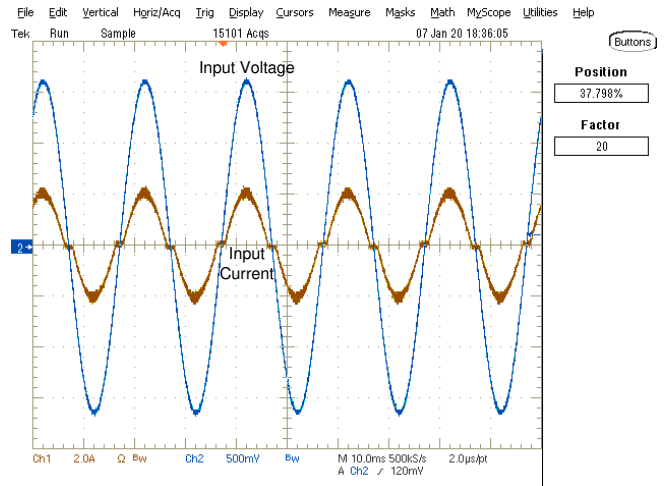

Figure 9. Input Current of UCC28064A EVM (UCC28064EVM-004) With Controller Replaced by UCC28065, $V_{IN} = 115$ VAC, $P_{OUT} = 300$ W

In the UCC28064A EVM design, the switching frequency is around 50 kHz at full load, peak of the line at the minimum input voltage. This frequency is low enough that the frequency clamp is never activated at different load conditions. As a result, when replacing the UCC28064A with the UCC28065, the only change observed is the current shape at zero crossing. It can be observed that the UCC28065 has the flat portion when the input current is zero crossing. Even with this distortion, the input current still maintains a high power factor and is able to pass the harmonic standard. The UCC28064A EVM (UCC28064EVM_004) schematic is shown in Figure 10.

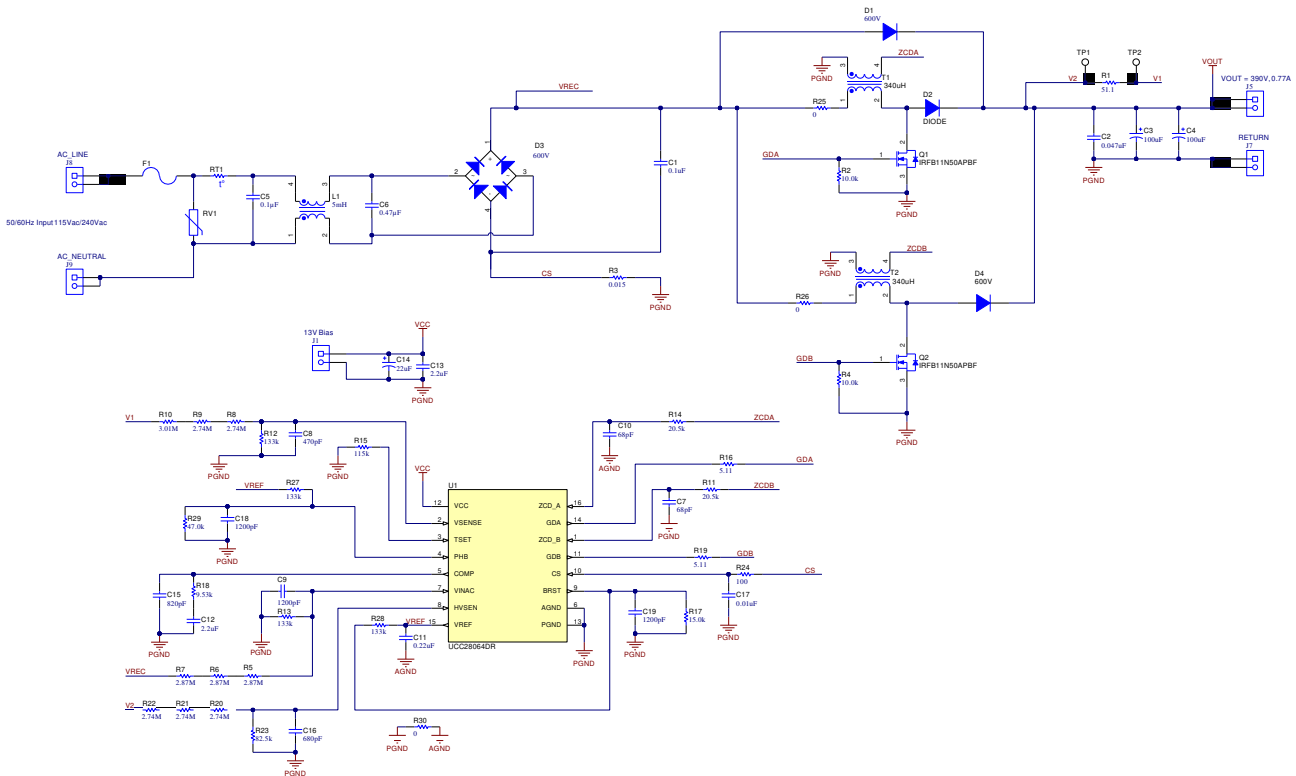

Figure 10. UCC28064A EVM (UCC28064EVM_004) Schematic

To fully demonstrate the higher switching frequency capability, the UCC28064A EVM can be modified using UCC28065 and much smaller Boost inductors, with minimum modification to the EVM components. The changes made from the UCC28064A EVM are listed in [Table 2](#).

Table 2. Component Changes on UCC28064EVM-004 for UCC28065 Evaluation

Controller	Component Designator	UCC28064A	UCC28065
Boost Inductor	T1, T2	340 μ H	110 μ H
TSET Pin Resistor	R15	115 k Ω	300 k Ω
PFC MOSFETs	Q1, Q2	IRFB11N60APBF	STF33N60M6
Burst Level Setting Resistor	R17	15 k Ω	7.5 k Ω
PHB Setting Resistor	R29	47 k Ω	36.5 k Ω

Other than changing the controller IC, the major changes of the board are the Boost inductors. The Boost inductors with roughly 1/3 of the original inductance are used in this modified board. Because of the much smaller inductor value, the Boost inductor size is largely reduced. As demonstrated in [Table 3](#) and [Figure 11](#), the new inductor can achieve approximately 25% diameter reduction and approximately 30% height reduction.

Table 3. Boost Inductor Comparison

	Inductor Value	Inductor Dimensions	Switching Frequency @ 90 V 300 W
UCC28064A	340 μ H	D: 38 mm, H: 17.5 mm	53.5 kHz
UCC28065	110 μ H	D: 28.3 mm, H: 12.3 mm	165 kHz



Figure 11. Boost Inductor Comparison

Because of a much smaller Boost inductor, the timing of the PFC control changes. Some further modification is required. Firstly, the TSET pin resistor value needs to be adjusted. The TSET pin resistor sets up the gain between the PFC switch on time and the COMP pin voltage. With a higher switching frequency, the gain is expected to be smaller. Therefore, the TSET resistor value needs to be increased. Please note here that due to the design change, the larger TSET value gives a smaller gain for the UCC28064A and UCC28065 devices. While in the earlier generation devices, UCC28063 and before, the smaller TSET resistor value gives a smaller gain. The [UCC28065 design calculator](#) can be used to calculate the suitable TSET pin resistor value with the new inductor. A 300-k Ω resistor is used for the design.

Besides the TSET pin resistor value change, the PHB and the BRST pin voltage level can be adjusted to further optimize the light load operation performance. [Table 2](#) gives some initial recommended values. Further adjustment might be needed to get the optimal performance for the design target.

Furthermore, the PFC MOSFET should be changed to get a better high-frequency operation performance. The UCC28064A EVM uses an old generation MOSFET. There are much better performance Si-based MOSFETs available today that offer lower on-state resistance and lower junction capacitance. The latest GaN technology further improves the performance of the MOSFET through much less junction parasitic capacitances. Both of these devices would further help to improve the overall converter performance.

With all these modifications, the efficiency and power factor performance are summarized in [Figure 12](#) and [Figure 13](#).

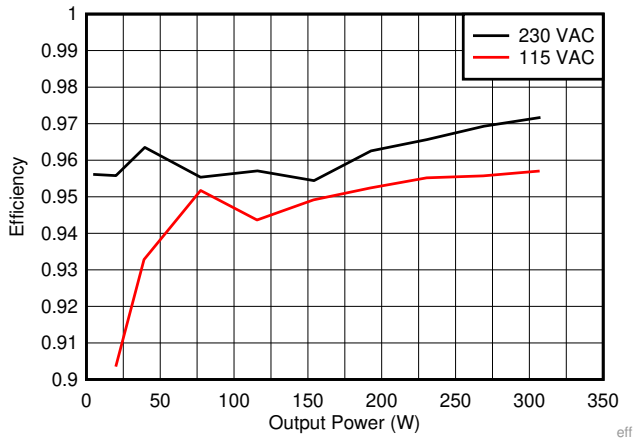

Figure 12. UCC28065 Efficiency at Different Line and Load Conditions

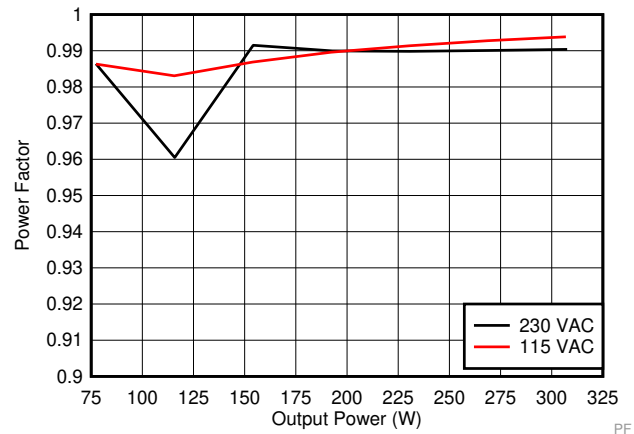

Figure 13. UCC28065 Power Factor at Different Line and Load Conditions

5 Summary

The interleaved TM PFC provides a high-efficiency, high-performance, and low-cost solution for many applications. To further reduce the converter size and improve the power density, the switching frequency needs to be increased. The UCC28065 device allows the converter to operate up to 800 kHz, doubling or tripling switching frequency of current interleaved TM PFC design. The UCC28065 device is a preferred solution for high-frequency interleaved TM PFC designs.

6 References

- Texas Instruments, [UCC28065 Natural Interleaving™ Transition-Mode PFC Controller with High Light-Load Efficiency Supporting High-Frequency Switching up to 800 kHz Data Sheet](#)
- Texas Instruments, [UCC28064A Natural Interleaving™ Transition-Mode PFC Controller with High Light-Load Efficiency Data Sheet](#)
- Texas Instruments, [UCC28064EVM-004 User's Guide](#)
- Texas Instruments, [An Interleaving PFC Pre-Regulator for High-Power Converters](#), Power Supply Design Seminar 2006-2007, SEM1700, Topic 5

IMPORTANT NOTICE AND DISCLAIMER

TI PROVIDES TECHNICAL AND RELIABILITY DATA (INCLUDING DATASHEETS), DESIGN RESOURCES (INCLUDING REFERENCE DESIGNS), APPLICATION OR OTHER DESIGN ADVICE, WEB TOOLS, SAFETY INFORMATION, AND OTHER RESOURCES "AS IS" AND WITH ALL FAULTS, AND DISCLAIMS ALL WARRANTIES, EXPRESS AND IMPLIED, INCLUDING WITHOUT LIMITATION ANY IMPLIED WARRANTIES OF MERCHANTABILITY, FITNESS FOR A PARTICULAR PURPOSE OR NON-INFRINGEMENT OF THIRD PARTY INTELLECTUAL PROPERTY RIGHTS.

These resources are intended for skilled developers designing with TI products. You are solely responsible for (1) selecting the appropriate TI products for your application, (2) designing, validating and testing your application, and (3) ensuring your application meets applicable standards, and any other safety, security, or other requirements. These resources are subject to change without notice. TI grants you permission to use these resources only for development of an application that uses the TI products described in the resource. Other reproduction and display of these resources is prohibited. No license is granted to any other TI intellectual property right or to any third party intellectual property right. TI disclaims responsibility for, and you will fully indemnify TI and its representatives against, any claims, damages, costs, losses, and liabilities arising out of your use of these resources.

TI's products are provided subject to TI's Terms of Sale (www.ti.com/legal/termsofsale.html) or other applicable terms available either on ti.com or provided in conjunction with such TI products. TI's provision of these resources does not expand or otherwise alter TI's applicable warranties or warranty disclaimers for TI products.

Mailing Address: Texas Instruments, Post Office Box 655303, Dallas, Texas 75265
Copyright © 2020, Texas Instruments Incorporated