

Using the UCC28C56EVM-066 High-Density 40-W Auxiliary Power Supply for 800-V Traction Inverters



Table of Contents

1 General Texas Instruments High Voltage Evaluation (TI HV EVM) User Safety Guidelines	2
2 Description	3
2.1 EVM Electrical Performance Specifications	4
3 Schematic Diagram	5
4 EVM Setup and Operation	6
4.1 Recommended Test Equipment	6
4.2 External Connections	6
4.3 EVM Test Points	8
5 Performance Data	9
5.1 Efficiency versus load, 10% to 100% load	9
5.2 Efficiency versus VIN at 100% load	9
5.3 Power loss versus load, 10% to 100% load	10
5.4 Load regulation, 10% to 100% load	10
5.5 Light load regulation, 0 mA to 200 mA load	11
5.6 Line regulation, various loads	11
5.7 Startup Waveforms	12
5.8 Shutdown Waveforms	14
5.9 Output voltage ripple	16
5.10 Steady state switching waveforms	18
5.11 Transient load waveforms	20
5.12 Over current / short circuit protections	22
5.13 Stability Measurements	24
5.14 Thermal Measurements	26
6 Assembly and Printed Circuit Board (PCB)	30
7 Bill of Materials (BOM)	32
8 Revision History	35

Trademarks

All trademarks are the property of their respective owners.

1 General Texas Instruments High Voltage Evaluation (TI HV EVM) User Safety Guidelines



Always follow TI's setup and application instructions, including use of all interface components within their recommended electrical rated voltage and power limits. Always use electrical safety precautions to help ensure your personal safety and those working around you. Contact TI's Product Information Center <http://support/ti.com> for further information.

Save all warnings and instructions for future reference.

WARNING

Failure to follow warnings and instructions may result in personal injury, property damage or death due to electrical shock and burn hazards.

The term TI HV EVM refers to an electronic device typically provided as an open framed, unenclosed printed circuit board assembly. It is *intended strictly for use in development laboratory environments, solely for qualified professional users having training, expertise and knowledge of electrical safety risks in development and application of high voltage electrical circuits. Any other use and/or application are strictly prohibited by Texas Instruments.* If you are not suitable qualified, you should immediately stop from further use of the HV EVM.

1. Work Area Safety

- a. Keep work area clean and orderly.
- b. Qualified observer(s) must be present anytime circuits are energized.
- c. Effective barriers and signage must be present in the area where the TI HV EVM and its interface electronics are energized, indicating operation of accessible high voltages may be present, for the purpose of protecting inadvertent access.
- d. All interface circuits, power supplies, evaluation modules, instruments, meters, scopes and other related apparatus used in a development environment exceeding 50Vrms/75VDC must be electrically located within a protected Emergency Power Off EPO protected power strip.
- e. Use stable and nonconductive work surface.
- f. Use adequately insulated clamps and wires to attach measurement probes and instruments. No freehand testing whenever possible.

2. Electrical Safety

As a precautionary measure, it is always a good engineering practice to assume that the entire EVM may have fully accessible and active high voltages.

- a. De-energize the TI HV EVM and all its inputs, outputs and electrical loads before performing any electrical or other diagnostic measurements. Revalidate that TI HV EVM power has been safely de-energized.
- b. With the EVM confirmed de-energized, proceed with required electrical circuit configurations, wiring, measurement equipment connection, and other application needs, while still assuming the EVM circuit and measuring instruments are electrically live.
- c. After EVM readiness is complete, energize the EVM as intended.

WARNING

While the EVM is energized, never touch the EVM or its electrical circuits, as they could be at high voltages capable of causing electrical shock hazard.

3. Personal Safety

- a. Wear personal protective equipment (for example, latex gloves or safety glasses with side shields) or protect EVM in an adequate lucent plastic box with interlocks to protect from accidental touch.

Limitation for safe use:

EVMs are not to be used as all or part of a production unit.

2 Description

The UCC28C56EVM-066 is a highly efficient primary-side controlled (using an AUX winding) flyback auxiliary power supply for EV/HEV automotive power trains. The design provides 15.2-V_{TYP}, 40-W output for 800-V battery systems. It will deliver 40 W over the input voltage range from 125 V to 1000 V. The exact output voltage is load dependent. From 40-V to 125-V input the design will supply 20 W. The EVM utilizes a 1700-V silicon-carbide (SiC) MOSFET, making it ideal for 800-V battery systems.

The EVM is a 4-layer board with the top and bottom layers dedicated to signal and power routing. The two inner layers are used only to route test points. In effect, this is a low-cost two-layer PCB. The controller and its associated power components are tightly compacted into a **50 mm x 86 mm** area, highlighted by the white rectangle shown on the top silkscreen. Note, C1 is not included with the critical components because it's considered to be part of the general VIN bypass capacitors in the system.

Every effort was made to use automotive qualified components. An automotive qualified 1700-V SiC MOSFET is listed in the BOM. The flyback transformer should be automotive qualified with consultation from the given transformer manufacturer.



Figure 2-1. UCC28C56EVM-066, HVP066E2, Top View

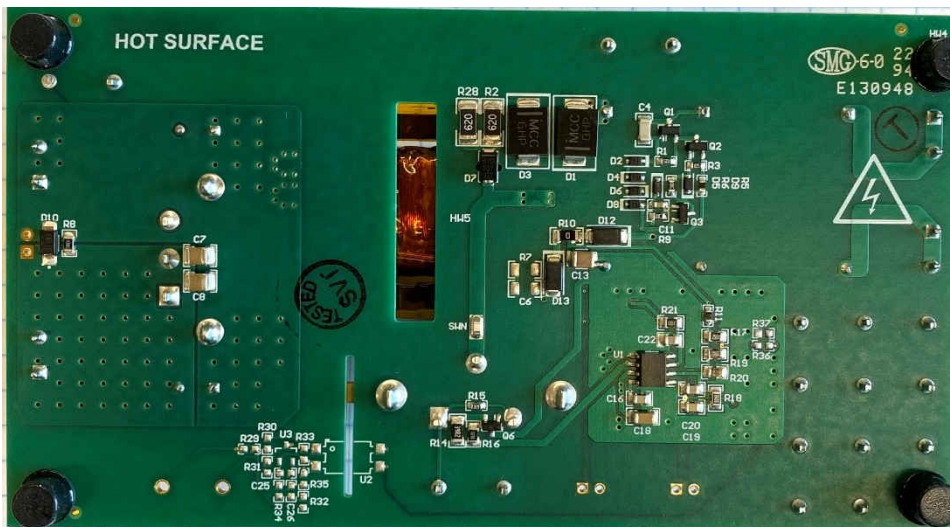

Figure 2-2. UCC28C56EVM-066, HVP066E2, Bottom View

2.1 EVM Electrical Performance Specifications

Table 2-1. EVM Electrical Specifications, $V_{IN} = 800$ Vdc, $T_A = 25^\circ\text{C}$ (unless otherwise noted)

PARAMETER		TEST CONDITIONS	MIN	TYP	MAX	UNIT
INPUT CHARACTERISTICS						
V_{IN}	Input voltage range		40	800	1000	V
V_{VDD_ON}	VDD start voltage		17.6	18.8	20.0	V
V_{VDD_OFF}	VDD stop voltage		15.0	15.5	16.0	V
I_{IN_FL}	Input current at full load	$V_{IN} = 1000$ V, $I_{OUT} = 2.7$ A	-	52	-	mA
		$V_{IN} = 40$ V, $I_{OUT} = 1.3$ A	-	590	-	
I_{IN_NL}	Input current at no load	$V_{IN} = 1000$ V	-	0.8	-	mA
		$V_{IN} = 40$ V	-	13	-	
OUTPUT CHARACTERISTICS						
V_{OUT}	100% load output	125 V $\leq V_{IN} \leq 1000$ V	-	15.2	-	V
	50% load output	40 V $\leq V_{IN} \leq 1000$ V	-	15.6	-	
	10% load output	40 V $\leq V_{IN} \leq 1000$ V	-	16.3	-	
	No load output	40 V $\leq V_{IN} \leq 1000$ V	-	19.3	-	
I_{OUT}	V_{OUT} load current range	125 V $\leq V_{IN} \leq 1000$ V	0	-	2.7	A
		40 V $\leq V_{IN} \leq 125$ V	0	-	1.3	
V_{OUT_REG}	Load regulation	250 mA $\leq I_{OUT} \leq 2.7$ A	-	± 3.5	-	%
		0 mA $\leq I_{OUT} \leq 200$ mA	4	-	25	
V_{OUT_RIPPLE}	PK-to-PK AC ripple	$V_{IN} = 1000$ V, $I_{OUT} = 2.7$ A, 1 MHz BWL	-	400	-	mV _{PP}
		$V_{IN} = 50$ V, $I_{OUT} = 1.3$ A, 1 MHz BWL	-	280	-	
$V_{OUT_SS_DELAY}$	V_{IN} applied to when V_{OUT} begins rising from 0 V	$V_{IN} = 50$ V, $I_{OUT} = 1.3$ A	-	255	-	ms
		$V_{IN} = 1000$ V, $I_{OUT} = 2.7$ A	-	230	-	
$V_{OUT_SS_trise}$	V_{OUT} soft start, rise time	$I_{OUT} = 2.7$ A	-	10	-	ms
$V_{OUT_SS_OS}$	V_{OUT} soft start overshoot	$V_{IN} = 1000$ V, $I_{OUT} = 2.7$ A	-	3.5	-	%
P_{MAX}	Maximum output power	125 V $\leq V_{IN} \leq 1000$ V	-	-	40	W
		40 V $\leq V_{IN} \leq 125$ V	-	-	20	
SYSTEMS CHARACTERISTICS						
η	Full load efficiency	$V_{IN} = 400$ V, $I_{OUT} = 2.7$ A	-	87.4	-	%
		$V_{IN} = 800$ V, $I_{OUT} = 2.7$ A	-	86.1	-	
f_{SW}	Switching frequency	$V_{IN} = 800$ V, $I_{OUT} = 2.7$ A	-	42.5	-	kHz
$I_{CS(OCL)}$	Current sense limit	$R_{CS} = 455$ m Ω	-	2.2	-	A
f_{CO}	Bandwidth	$V_{IN} = 800$ V, $I_{OUT} = 2.7$ A	-	625	-	Hz
		$V_{IN} = 50$ V, $I_{OUT} = 0.25$ A	-	3950	-	
PM	Phase Margin	$V_{IN} = 800$ V, $I_{OUT} = 2.7$ A	-	105	-	deg
		$V_{IN} = 50$ V, $I_{OUT} = 0.25$ A	-	87	-	
GM	Gain Margin	$V_{IN} = 800$ V, $I_{OUT} = 2.7$ A	-	40	-	dB
		$V_{IN} = 50$ V, $I_{OUT} = 0.25$ A	-	25	-	
ΔT_{MAX}	Max. temp. rise over T_{PCB}	T1 at 800 V_{IN} , $I_{OUT} = 2.7$ A, 40 W	-	48.9	-	$^\circ\text{C}$
		T1 at 1000 V_{IN} , $I_{OUT} = 2.7$ A, 40 W	-	55.3	-	

3 Schematic Diagram

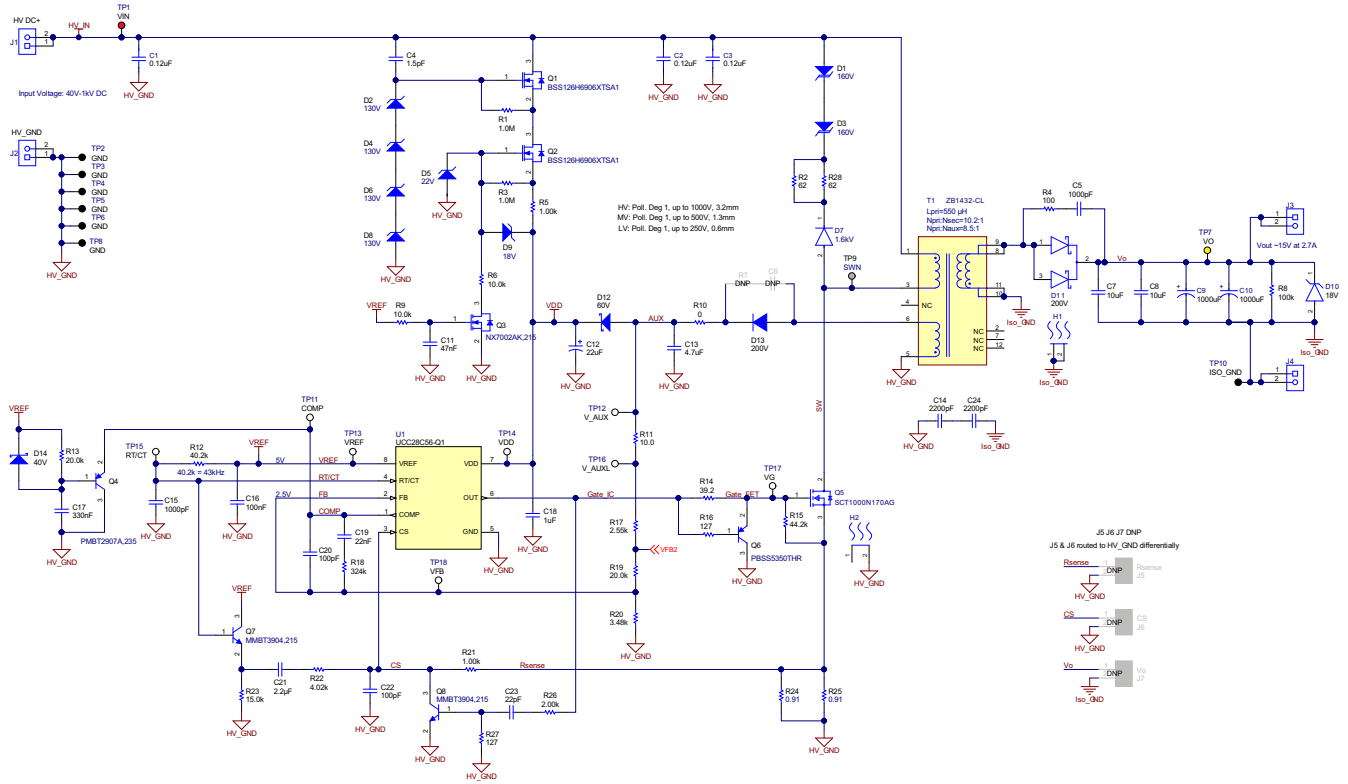

Figure 3-1. UCC28C56EVM-066 Schematic.

4 EVM Setup and Operation

Safety: This evaluation module is not encapsulated and there are accessible voltages that are greater than 50 V_{DC}.

Isolation Input Transformer: A suitably rated 1:1 isolation transformer shall be used on the input(s) to this EVM and be constructed in a manner in which the primary winding(s) are separated from the secondary winding(s) by reinforced insulation, double insulation, or a screen connected to the protective conductor terminal.



WARNING

- If you are not trained in the proper safety of handling and testing power electronics please do not test this evaluation module.
- While the EVM is energized, never touch the EVM or its electrical circuits, as they could be at high voltages capable of causing electrical shock hazard.
- Caution Hot surface. Contact may cause burns. Do not touch!
- Read this user's guide thoroughly before making test.



WARNING

Caution: Do not leave EVM powered when unattended.

4.1 Recommended Test Equipment

1. V_{IN}: DC power supply, 40 V to 1000 V output, capable of supplying up to 2 A
2. I_{OUT}: Electronic load, capable of supporting at least 25 V with loads of 0 A to 3.0 A
3. Two DVMs measuring DC voltage
 - a. The DVM monitoring VIN+ must be able to withstand 1000 Vdc
4. Two DVMs measuring DC current
5. Oscilloscope: 4 channel, 500 MHz or better
 - a. Recommend three high voltage probes (rated to 1000 V CAT II, 2500 Vpk
 - b. Recommend one differential probe (±140V low range at 1/20, ±1400V high range at 1/200)
6. Thermal camera (optional) or thermocouple to measure T1 case temperature

4.2 External Connections

The UCC28C56EVM-066 EVM utilizes screw terminals for quickly connecting to V_{IN} and V_{OUT}. Connecting the appropriate ammeters and voltmeters, as shown in Figure 4-1, allows accurate EVM efficiency and load regulation measurements.

Setup and Connection of Test Equipment:

1. **Before connecting** it to the EVM, turn on and adjust the **VIN power supply to 50 V** and set its **current limit to 1.5 A**.
2. Turn off/disable the VIN power supply.
3. Connect the V_{IN} power supply to J2 (V_{IN+}) and J1 (GND).
4. Connect the variable load to J4 (V_{OUT+}) and J3 (ISO_GND).
5. Set the load to the constant current (CC) and 0.25 A. Enable the load.

Power on for the first time:

1. Verify VIN is off/disabled and no voltage is applied to the UUT.
2. Connect oscilloscope probes to VIN (20 V/DIV), VDD (4 V/DIV), and COMP (2 V/DIV).
3. Connect the differential probe to VO and ISO_GND at low range, 1/20 (scaled to 4 V/DIV).
4. Set the oscilloscope to single-trigger on VIN rising at 25 V. Set a time base of 50 ms/DIV.
5. Verify that the load is set to 0.25 A and is still enabled.
6. Turn on the VIN supply at 50 V. The oscilloscope should trigger and produce the waveforms shown in figure 5-6. If your result is the same as figure 5-6 then your EVM is functioning correctly, thus far. If your result does not resemble figure 5-6 then stop. Troubleshoot the EVM at 50 VIN. Do not increase VIN until after troubleshooting.
7. When VIN is **50 V only** and with 0.25 A load, verify the following DC measurements at the test points:
 - a. VOUT+ (yellow TP) to ISO_GND \approx 16.4 Vdc
 - b. V_AUX (white TP) to GND \approx 18.7 Vdc
 - c. VDD (white TP) to GND \approx 18.6 Vdc
 - d. VREF (white TP) to GND = 5.0 Vdc
 - e. FB (white TP) to GND = 2.5 Vdc
8. Turn off the VIN supply.
9. Increase VIN to 400 V with 1.3 A load and repeat steps 4 to 8. Verify that VOUT is OK at this condition.
10. Turn off the VIN supply.
11. Increase VIN to 800 V. At 800 V and 0.25 A load [and 2.7 A load] your result should be similar to figure 5-7 [and figure 5-8]. If your results are the same as figure 5-7 and 5-8 at 800 V then your EVM is 100% functioning correctly and you can proceed with other tests.

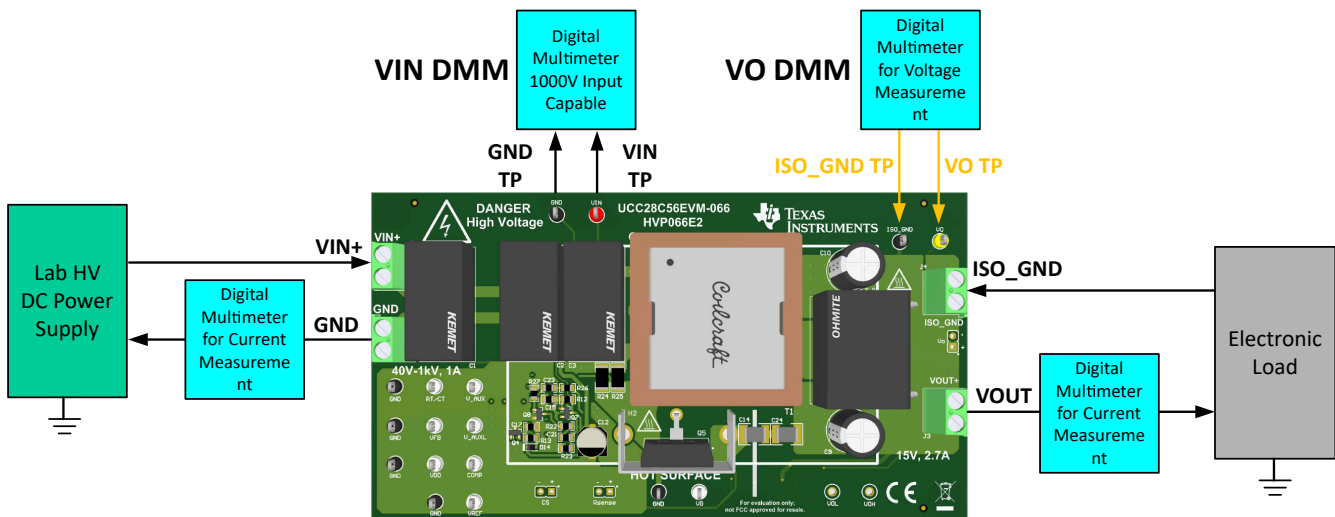

Figure 4-1. UCC28C56EVM-066, Recommended Efficiency and Typical Test Setup

4.3 EVM Test Points

Table 4-1 describes the various EVM test points, allowing easy access for connecting oscilloscope probes, DVM test leads and wire connections to lab test equipment.

Table 4-1. Input, Output, Test Point (I/O/TP) Description

PIN	I/O/TP	COLOR	DESCRIPTION	MIN	TYP	MAX
J1	-	Green	GND	-	0 V	-
J2	I	Green	VIN+	40 V	800 V	1000 V
J3	-	Green	ISO_GND	-	0 V	-
J4	O	Green	VOUT+ (depends on load)	14.5 V	15.5 V	20 V
VDD	TP	White	Analog controller bias supply	-	18.6 V	-
VREF	TP	White	Controller reference output	4.9 V	5 V	5.1 V
COMP	TP	White	Error amplifier output	0 V	-	5 V
VFB	TP	White	Inverting input to the error amplifier	2.45 V	2.5 V	2.55 V
RT/CT	TP	White	Fixed frequency triangle oscillator	0.9 V _{TYP}	1.4 V _{PP}	2.3 V _{PP}
VIN	TP	Red	Input voltage	40 V	-	1000 V
V_AUXL	TP	White	AUX voltage after a 10 ohm series resistor	-	18.7 V	-
V_AUX	TP	White	AUX output voltage	-	18.7 V	-
VG	TP	White	Voltage at the gate of the SiC MOSFET	0 V	18 V	-
SWN	TP	Silver	Switching node (bottom of the PCB)	0 V	-	V _{IN} + 480 V
VO	TP	Yellow	Output voltage	14.5 V	15.5 V	20 V
GND x5	TP	Black	GND	-	0 V	-
ISO_GND x2	TP	Black	Isolated GND	-	0 V	-

5 Performance Data

5.1 Efficiency versus load, 10% to 100% load

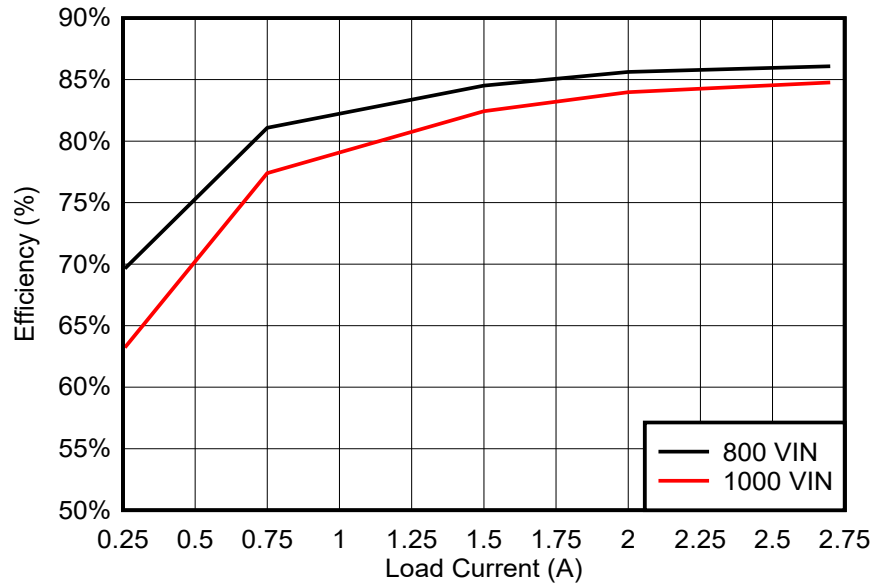

Figure 5-1. UCC28C56EVM Efficiency vs Load

5.2 Efficiency versus VIN at 100% load

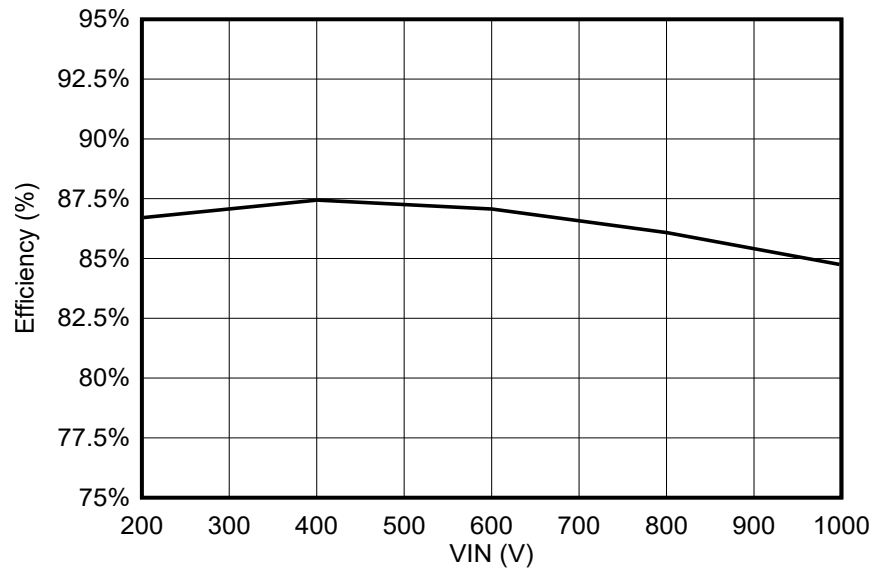

Figure 5-2. UCC28C56EVM Efficiency versus VIN at 100% load

5.3 Power loss versus load, 10% to 100% load

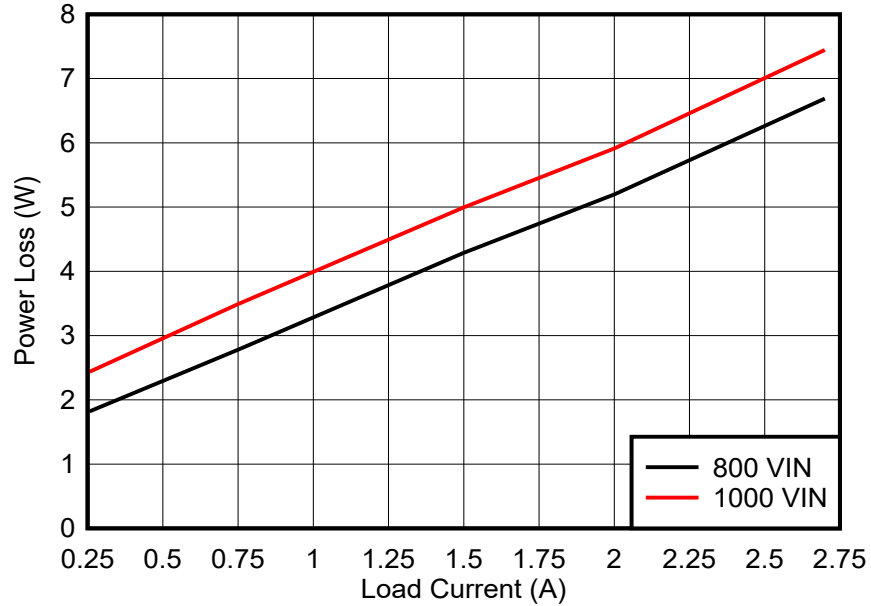

Figure 5-3. UCC28C56EVM Power loss versus load

5.4 Load regulation, 10% to 100% load

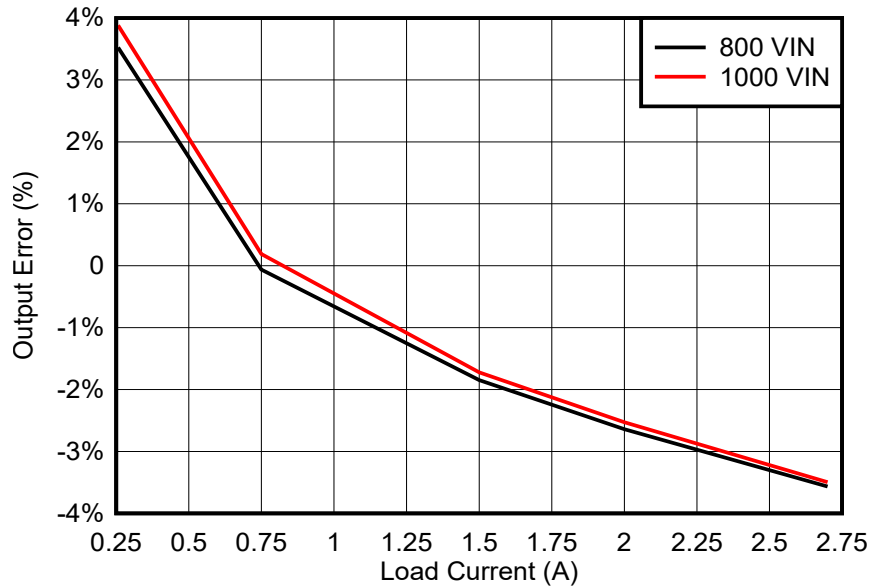

Figure 5-4. UCC28C56EVM Load regulation, 10% to 100% load

5.5 Light load regulation, 0 mA to 200 mA load

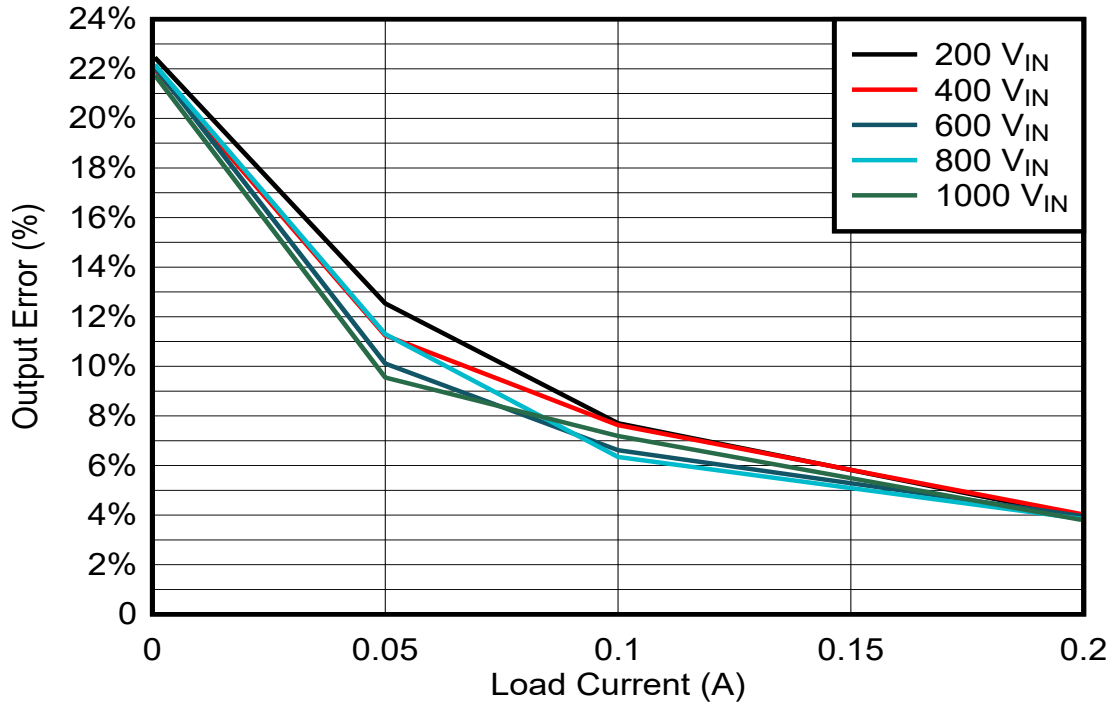

Figure 5-5. UCC28C56EVM Load Regulation, No load to 200 mA load

5.6 Line regulation, various loads

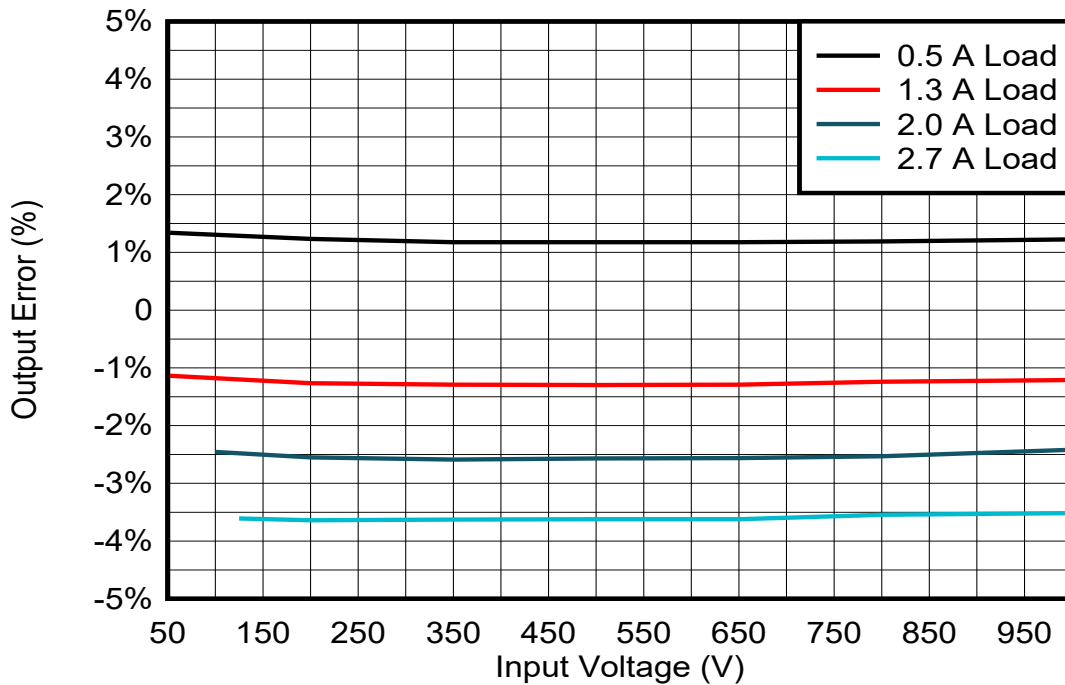

Figure 5-6. UCC28C56EVM Line regulation, various loads

5.7 Startup Waveforms

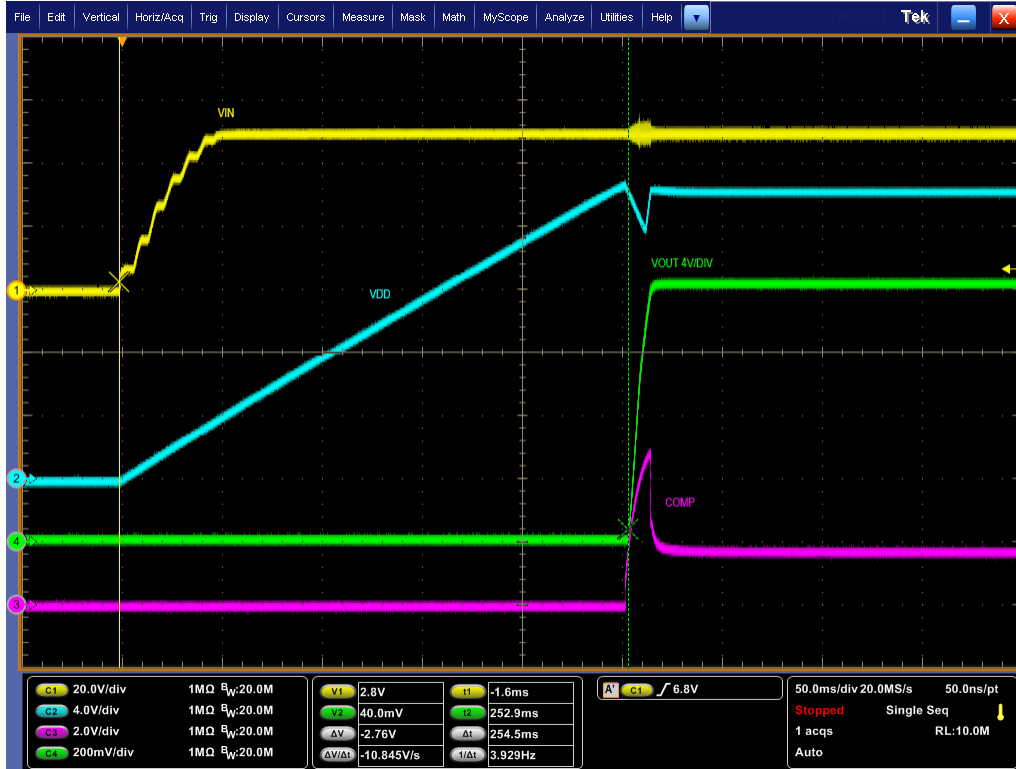

Figure 5-7. Start-Up 1: VIN = 50 V, Load = 0.25 A

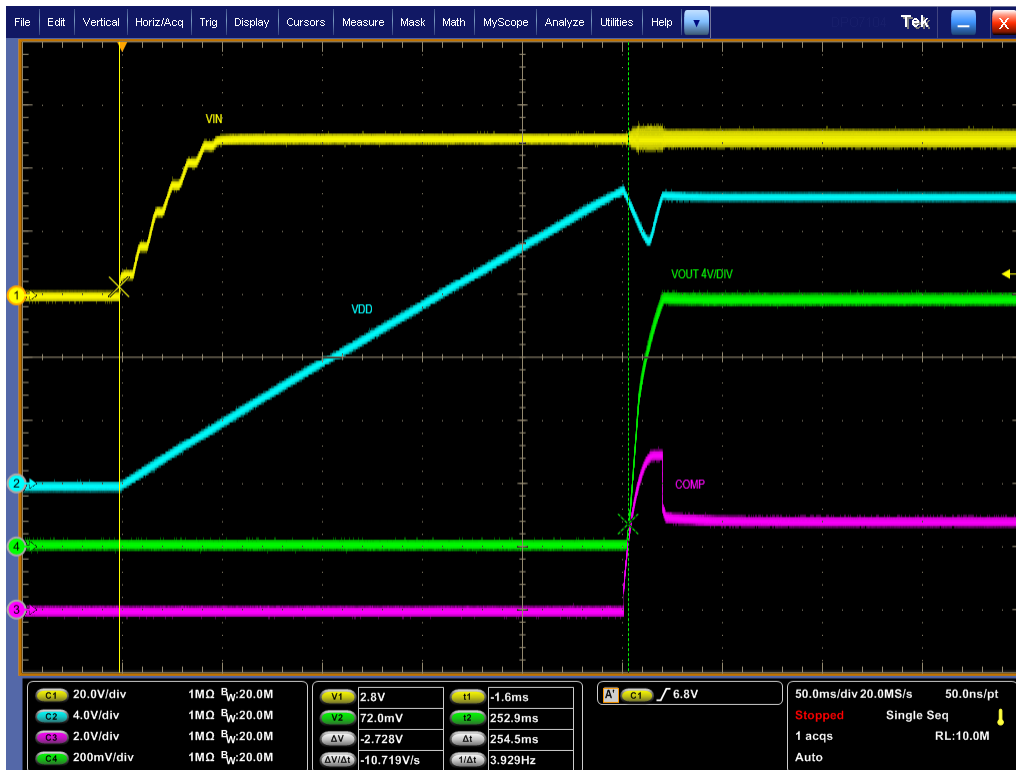

Figure 5-8. Start-Up 2: VIN = 50 V, Load = 1.3 A



Figure 5-9. Start-Up 3: VIN = 1000 V, Load = 0.25 A



Figure 5-10. Start-Up 4: VIN = 1000 V, Load = 2.7 A

5.8 Shutdown Waveforms



Figure 5-11. Shutdown, VIN Removal: VIN = 50 V, Load = 0.25 A



Figure 5-12. Shutdown, VIN Removal: VIN = 50 V, Load = 1.3 A



Figure 5-13. Shutdown, VIN Removal: VIN = 1000 V, Load = 0.25 A



Figure 5-14. Shutdown, VIN Removal: VIN = 1000 V, Load = 2.7 A

5.9 Output voltage ripple

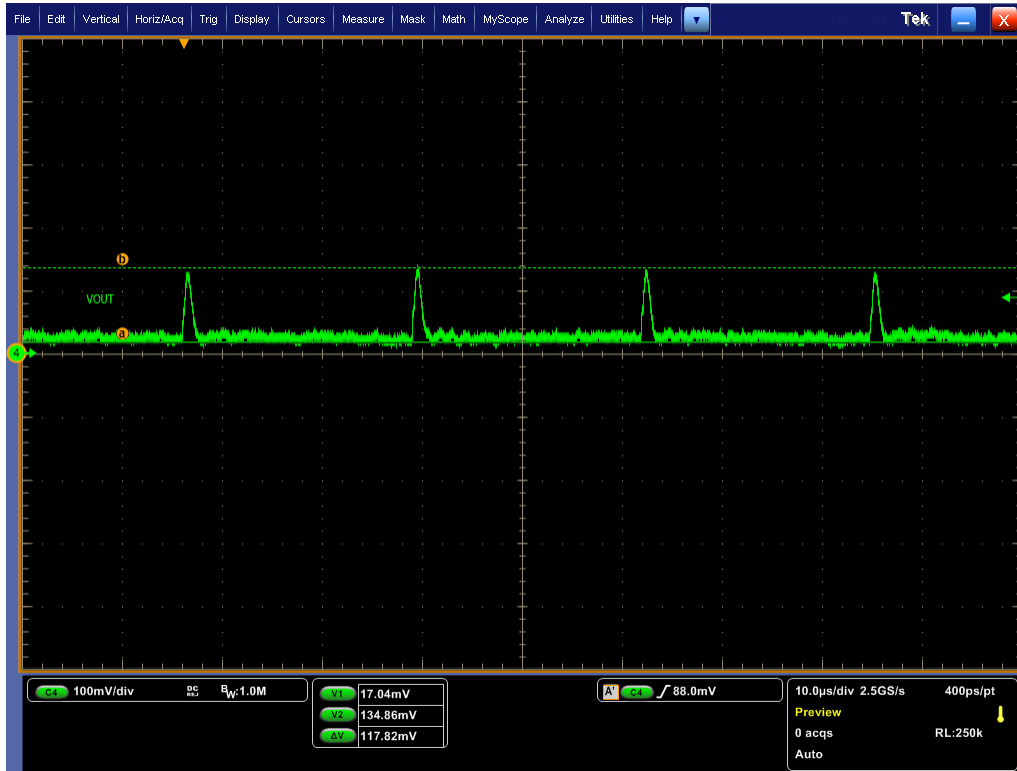

Figure 5-15. Output Voltage Ripple: VIN = 50 V, Load = 0.25 A

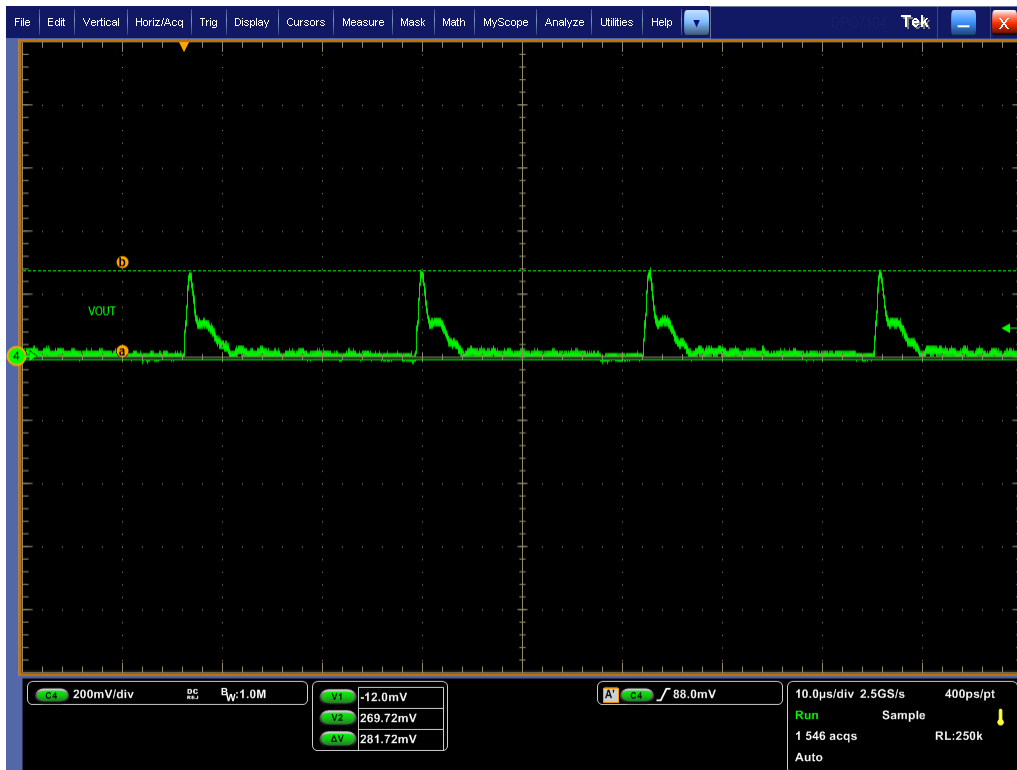

Figure 5-16. Output Voltage Ripple: VIN = 50 V, Load = 1.3 A

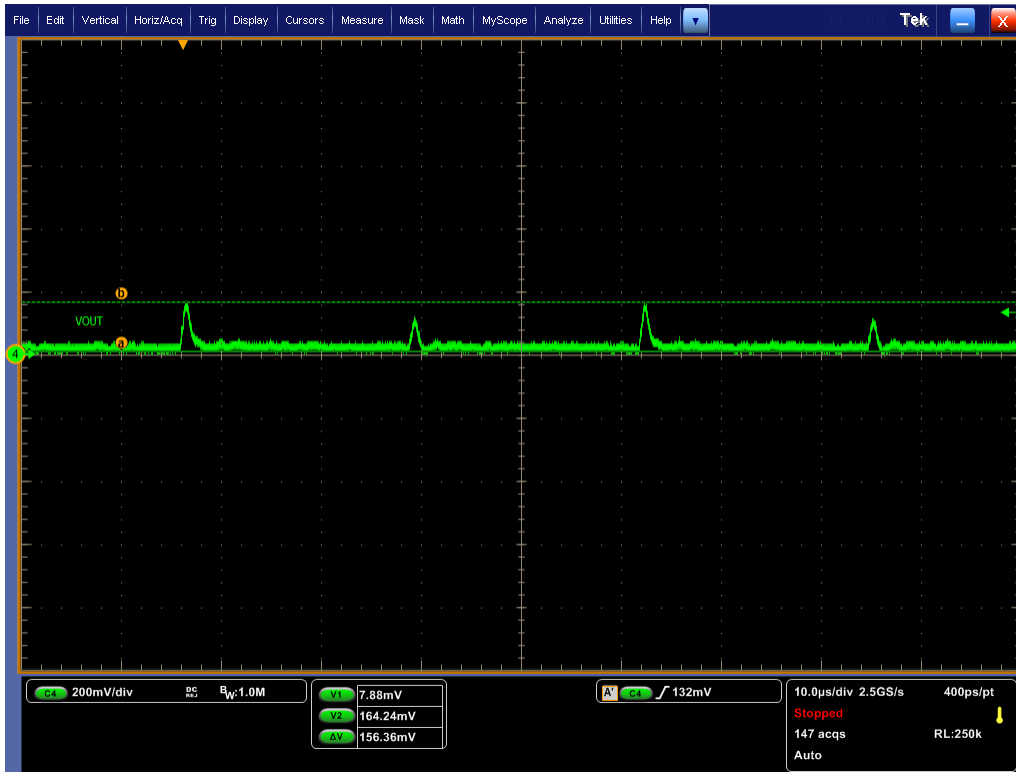

Figure 5-17. Output Voltage Ripple: VIN = 1000 V, Load = 0.25 A

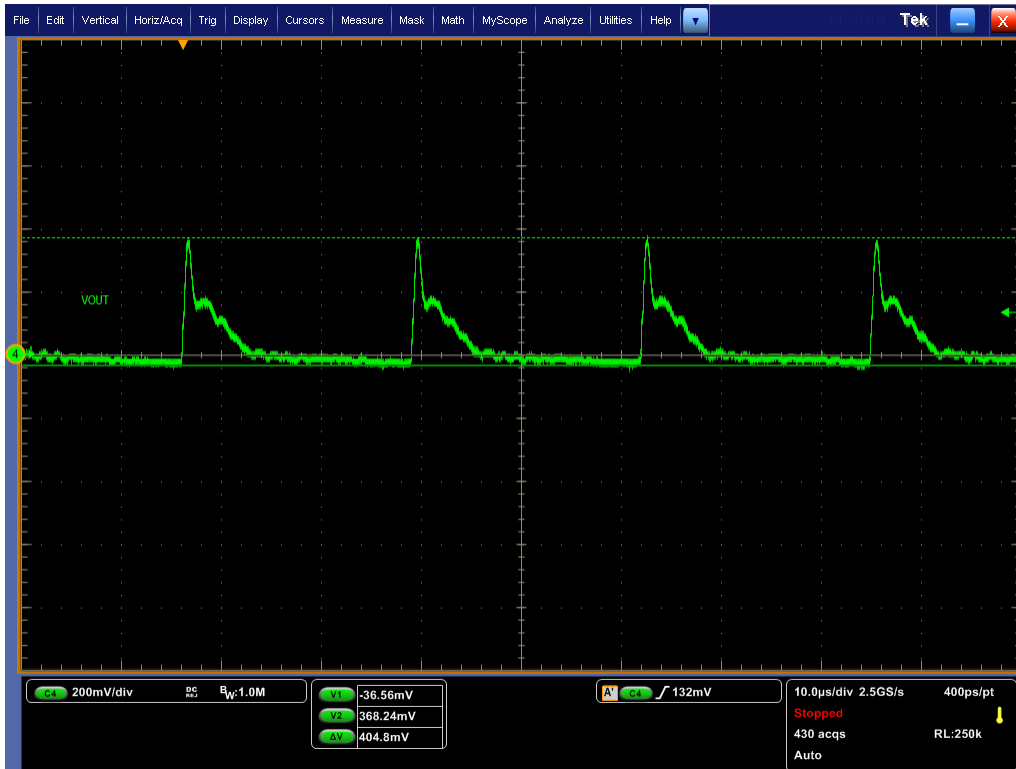

Figure 5-18. Output Voltage Ripple: VIN = 1000 V, Load = 2.7 A

5.10 Steady state switching waveforms



Figure 5-19. Steady State: VIN = 50 V, Load = 0.25 A



Figure 5-20. Steady State: VIN = 50 V, Load = 1.3 A

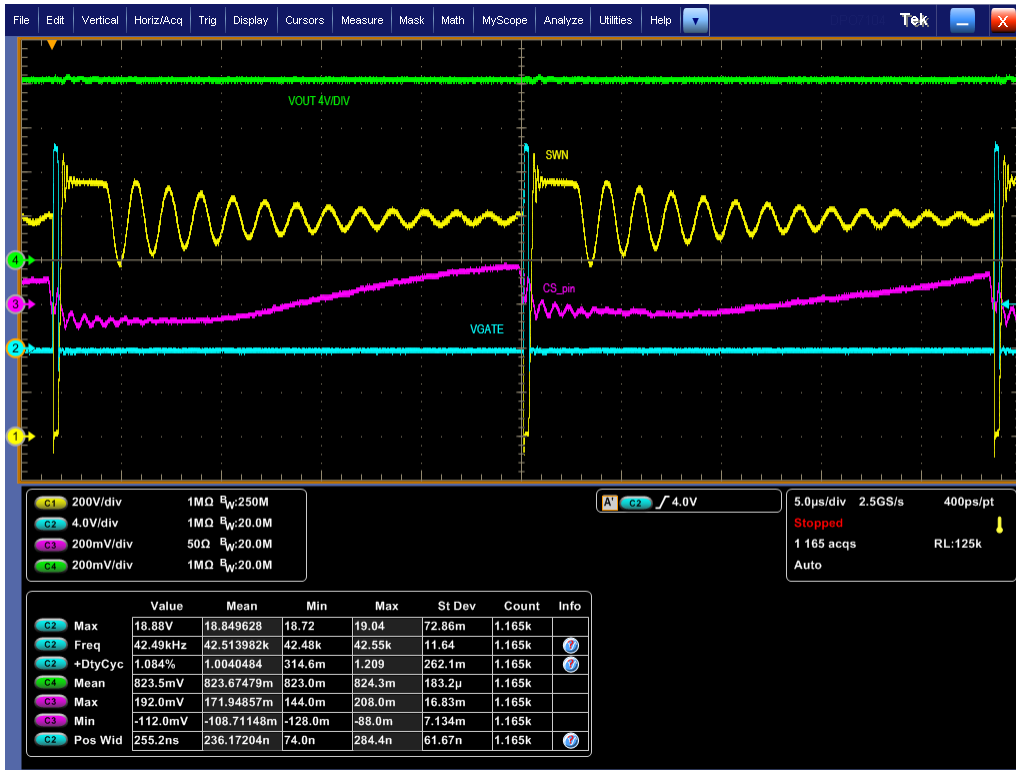

Figure 5-21. Steady State: VIN = 1000 V, Load = 0.25 A



Figure 5-22. Steady State: VIN = 1000 V, Load = 2.7 A

5.11 Transient load waveforms

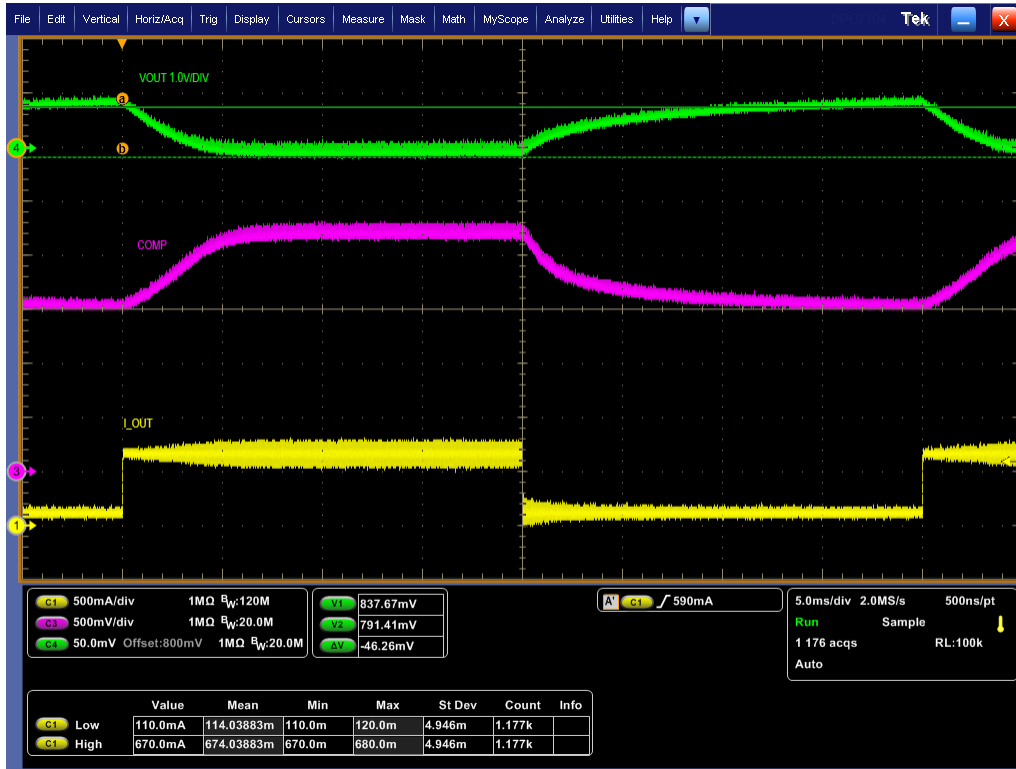

Figure 5-23. Transient Response: VIN = 50 V, Load = 100 mA to 650 mA at 25 Hz, 50% duty



Figure 5-24. Transient Response: VIN = 50 V, Load = 100 mA to 1.3 A at 25 Hz, 50% duty

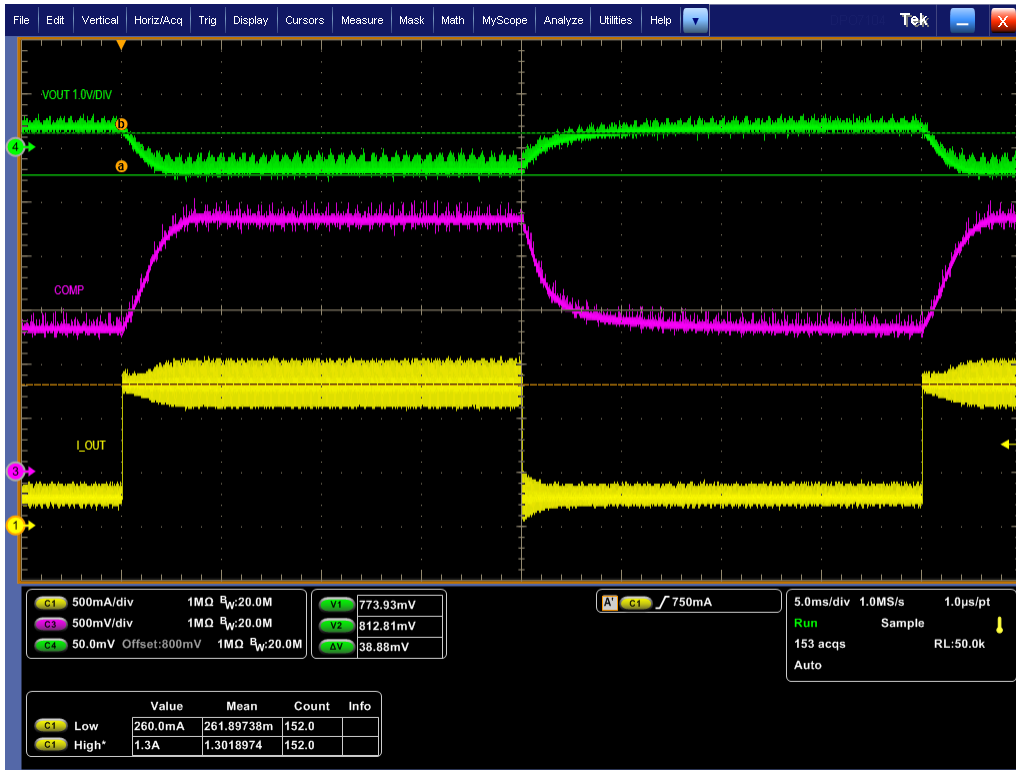

Figure 5-25. Transient Response: VIN = 800 V, Load = 0.25 A to 1.3 A at 25 Hz, 50% duty

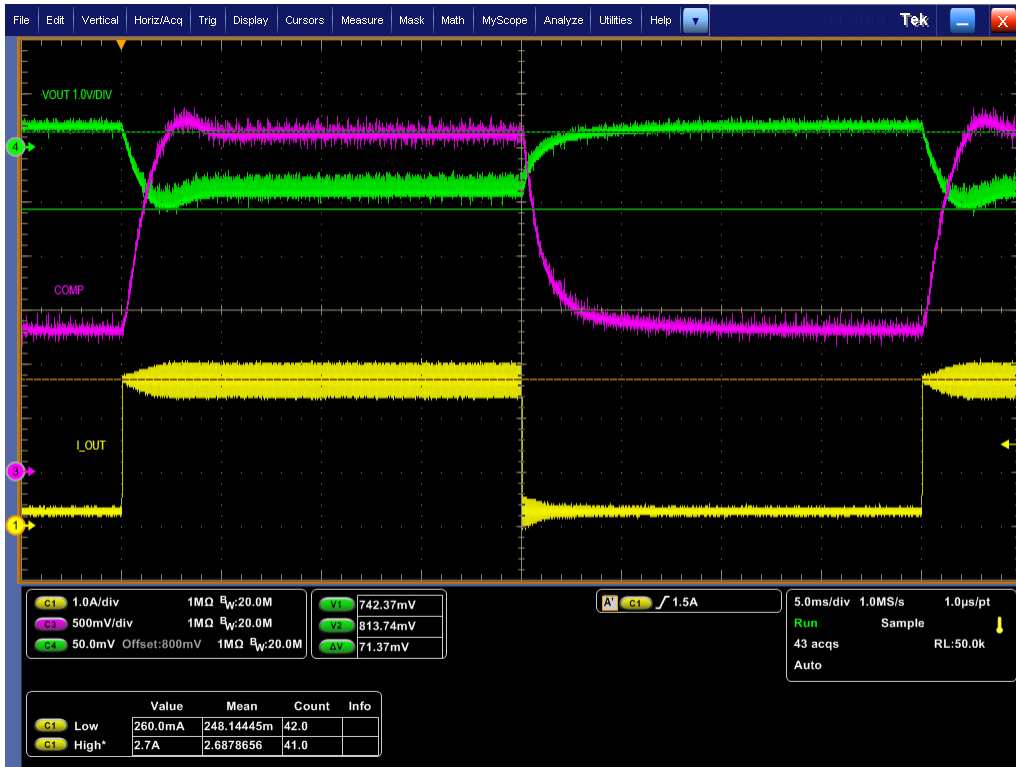

Figure 5-26. Transient Response: VIN = 800 V, Load = 0.25 A to 2.7 A at 25 Hz, 50% duty

5.12 Over current / short circuit protections



Figure 5-27. 50 VIN, Startup with output shorted to ground

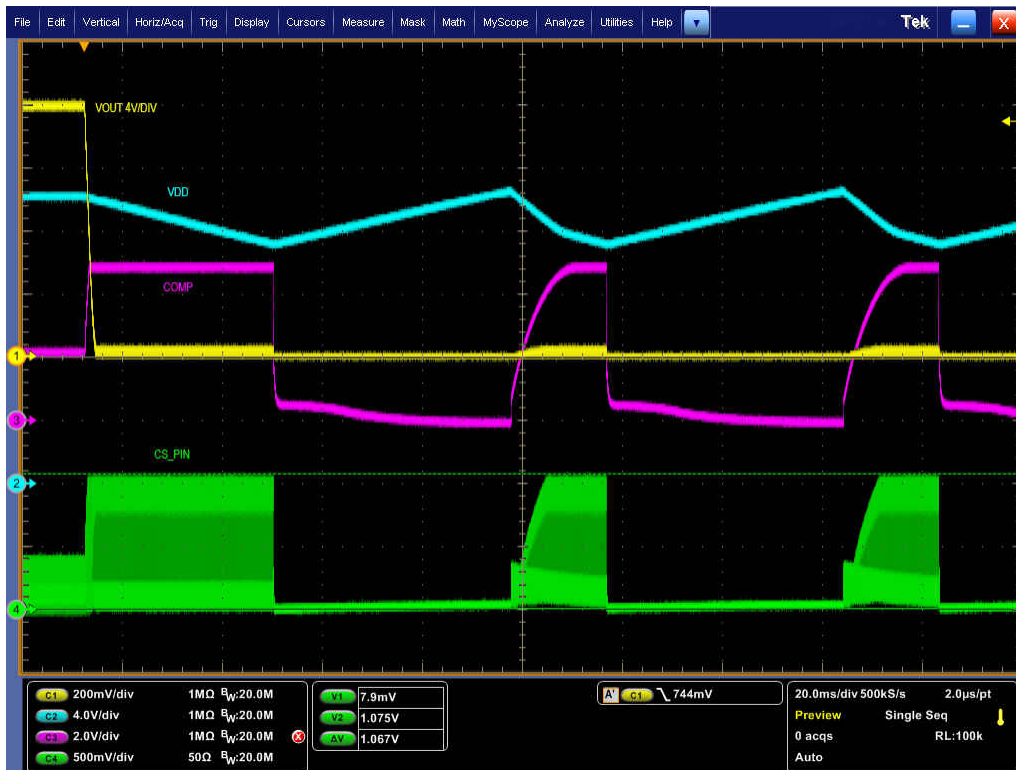

Figure 5-28. 50 VIN, Output shorted to ground during operation

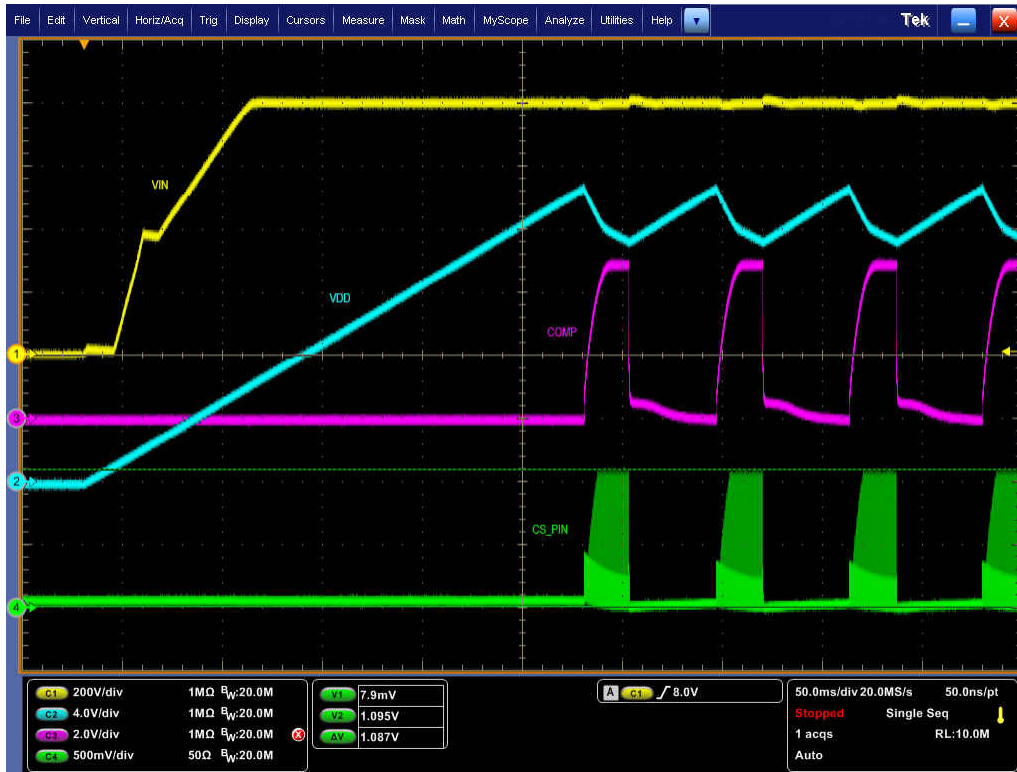

Figure 5-29. 800 VIN, Startup with output shorted to ground

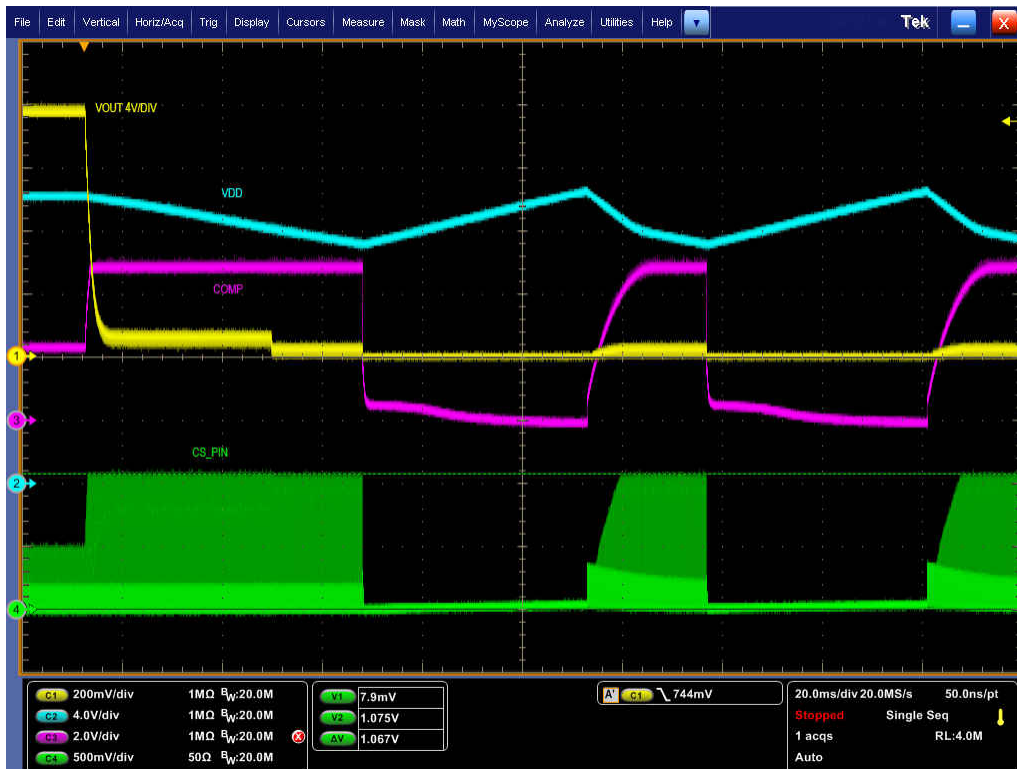

Figure 5-30. 800 VIN, Output shorted to ground during operation

5.13 Stability Measurements

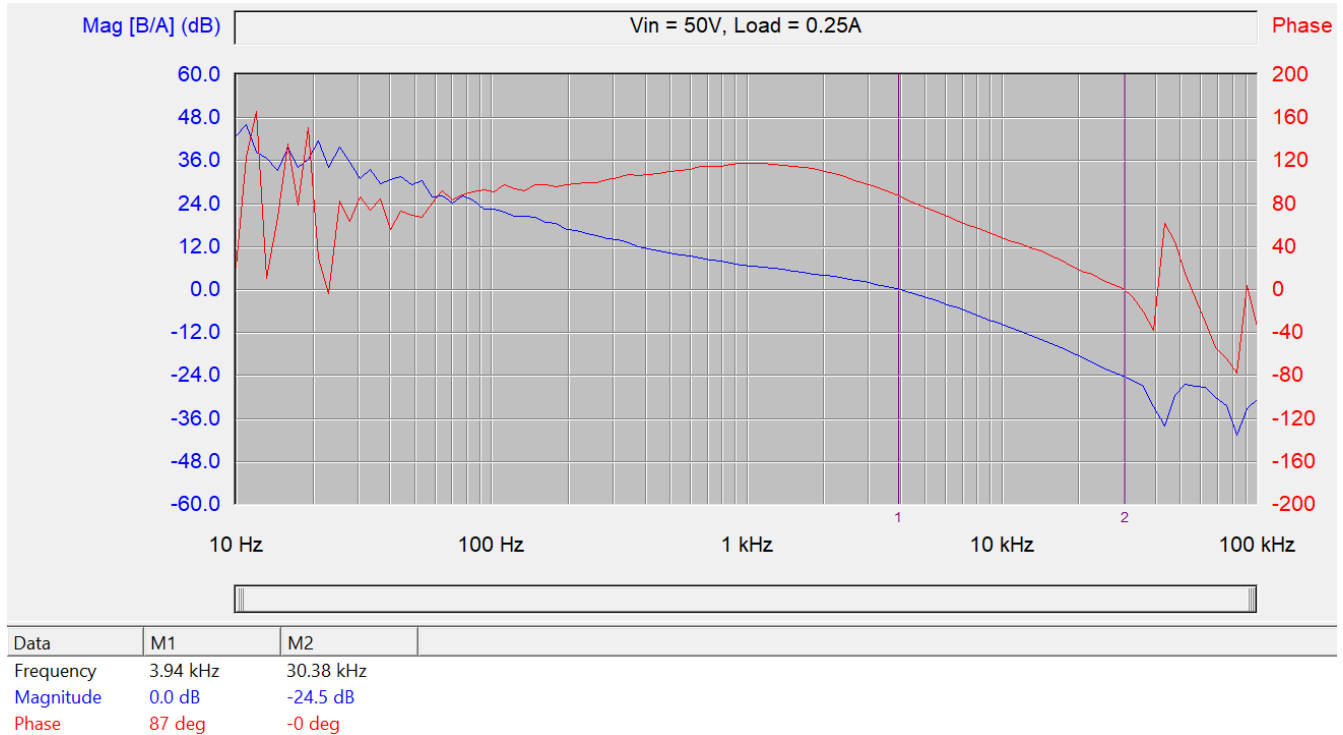

Figure 5-31. Bode Plot: VIN = 50 V, Load = 0.25A

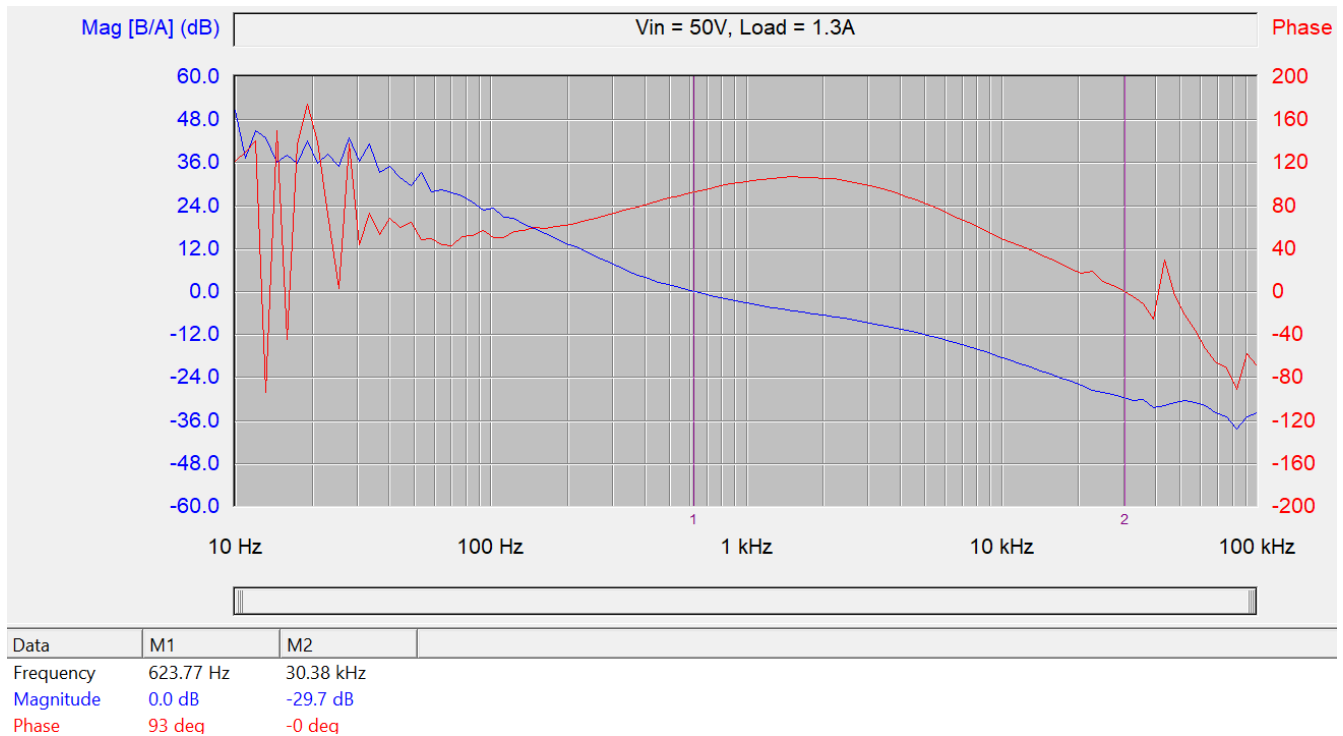

Figure 5-32. Bode Plot: VIN = 50 V, Load = 1.3 A

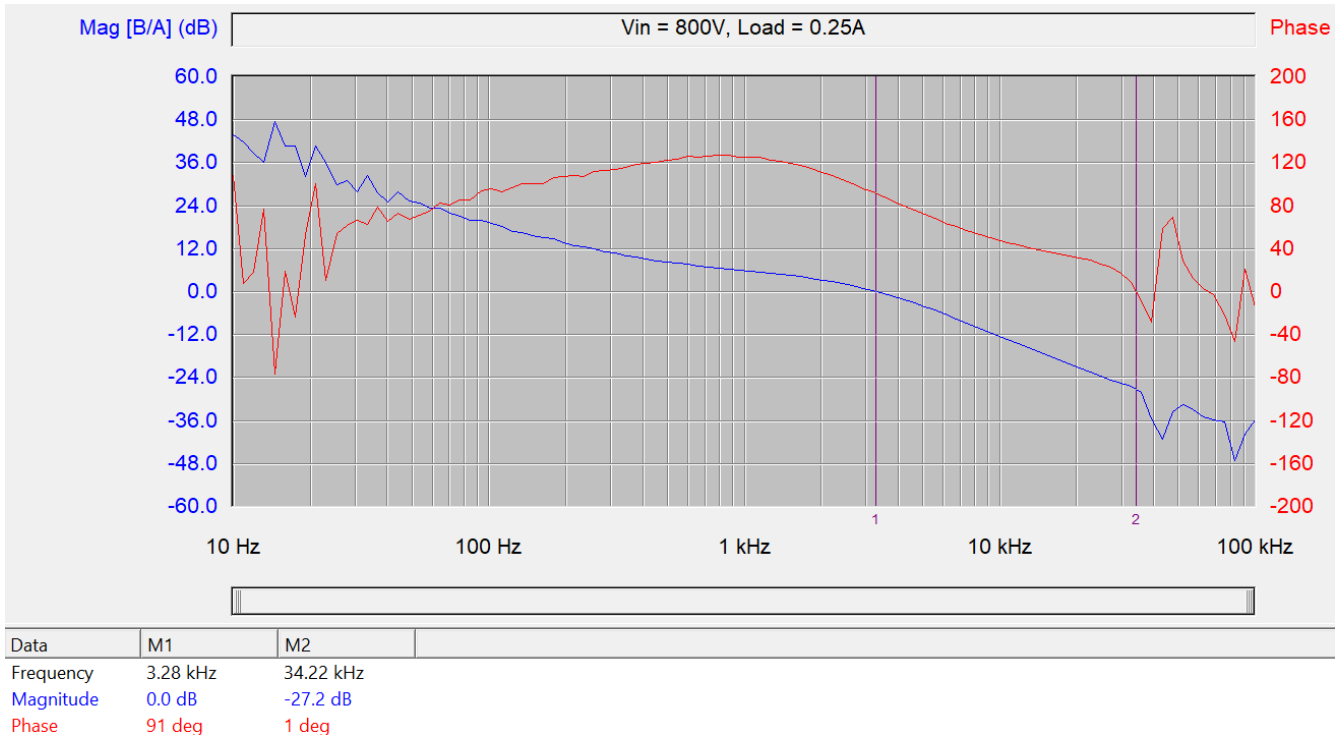

Figure 5-33. Bode Plot: VIN = 800 V, Load = 0.25 A

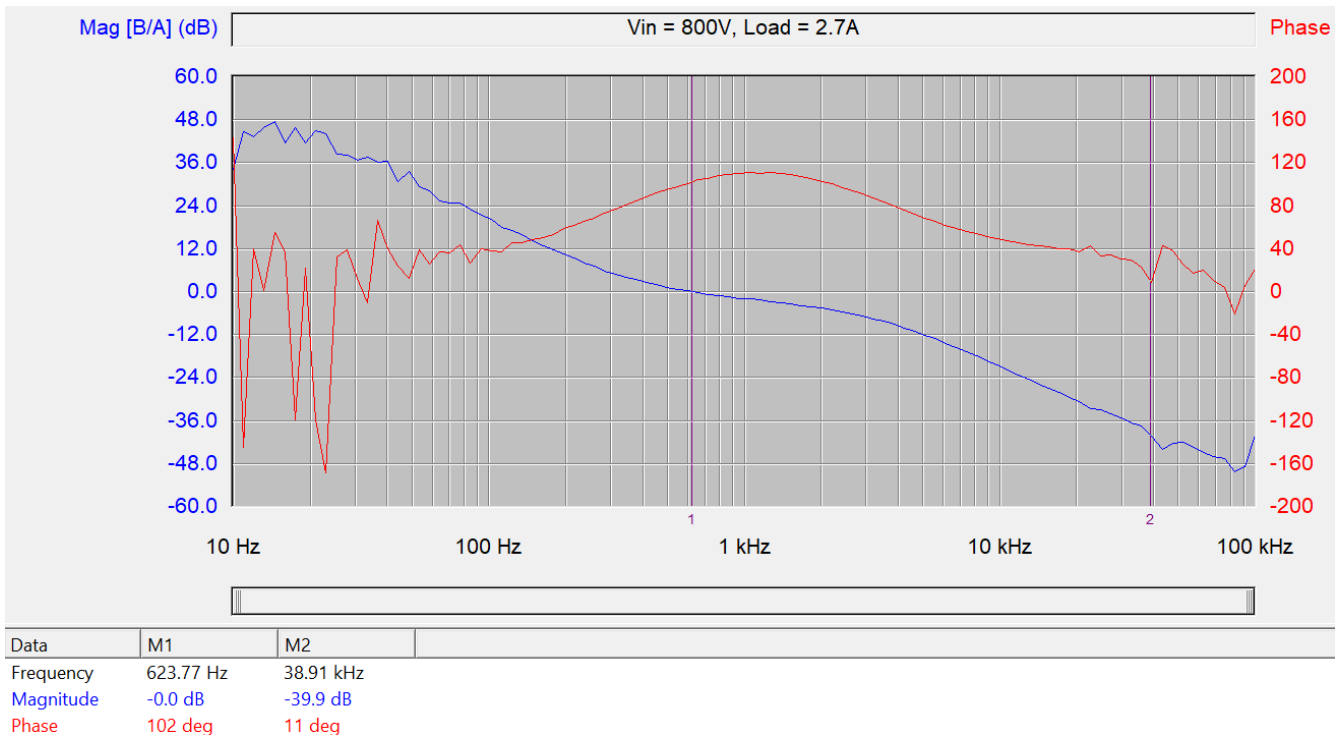

Figure 5-34. Bode Plot: VIN = 800 V, Load = 2.7 A

5.14 Thermal Measurements

Test Methodology:

As shown in figure 5-35, the UCC28C56H EVM was placed in a protective enclosure to isolate the high-voltage ($V_{IN} > 50V$) from test personnel. The enclosure did not provide any forced air movement (i.e. there are no fans). The following thermal results should be considered worst-case due to the dead-air environment. For each load condition, the soak time was **30 – 45 minutes**.

The hottest component on the EVM is the transformer. The transformer temperature was taken two ways: (1) by a thermocouple taped directly to the top of the windings (see figure 5-36), and (2) using a thermal camera and black electrical tape placed directly over the thermocouple/windings (see figure 5-37). The two methods provided results within 2 °C of each other. Temperature of the output rectifier diode and switching MOSFET were taken only with the thermal camera. The PCB temperature near the transformer was measured with a thermocouple.

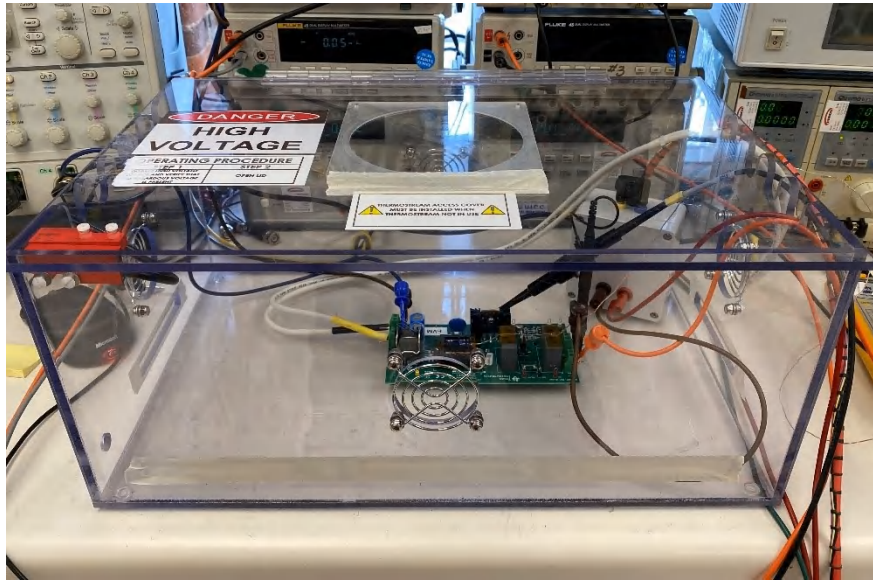

Figure 5-35. UCC28C56H EVM in plexiglass enclosure for HV safety. Virtually no airflow.

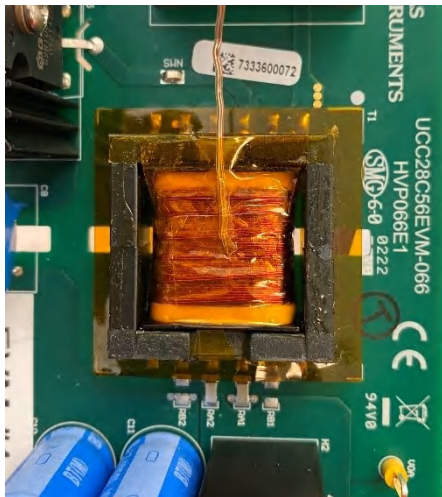

Figure 5-36. Thermocouple taped to windings



Figure 5-37. Black tape for thermal camera

Transformer Temperature vs Load

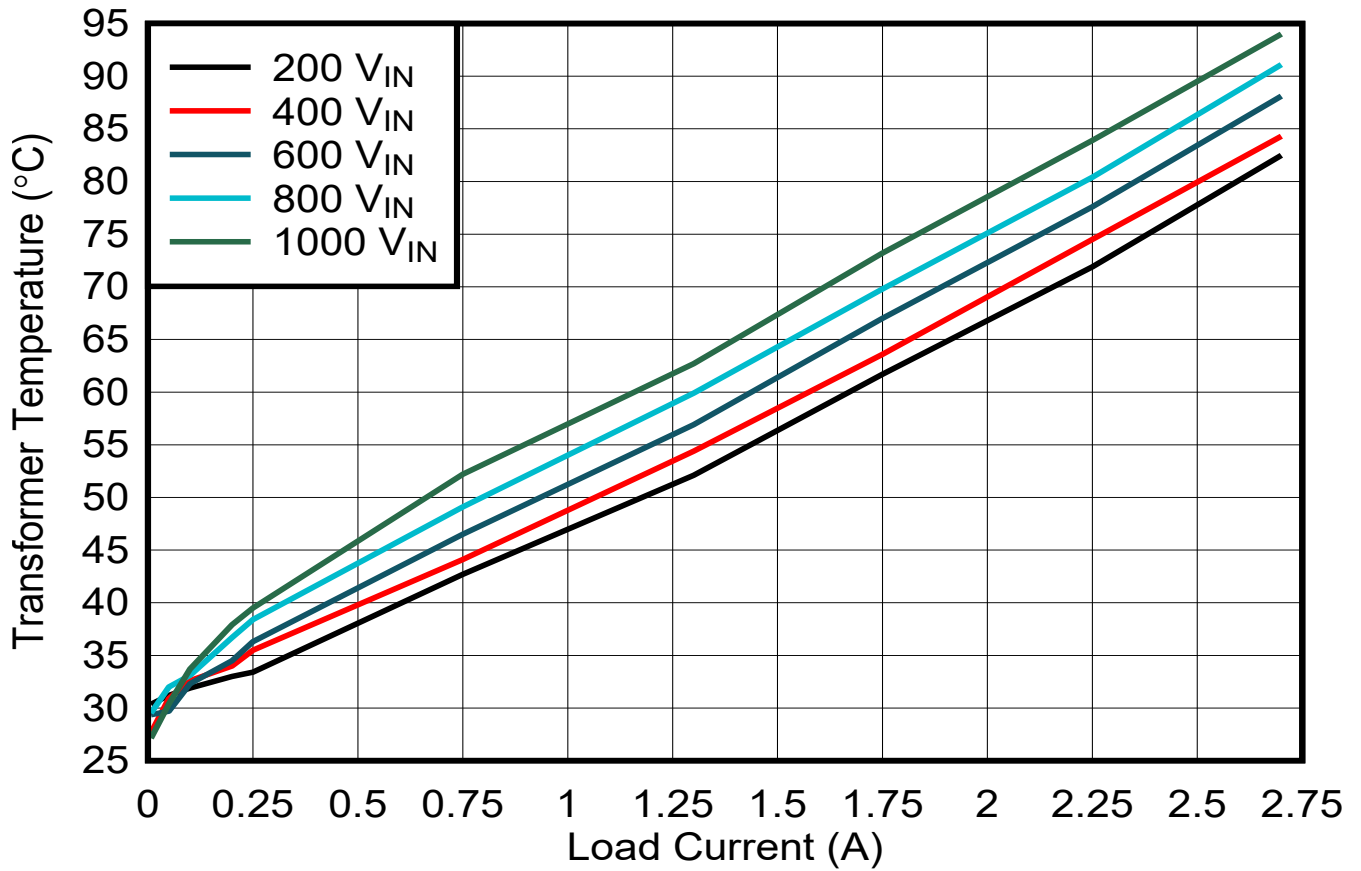

Figure 5-38. Transformer temperature vs load

Table 5-1. Thermal Results: VIN = 50 V, 1.3 A, 20 W load

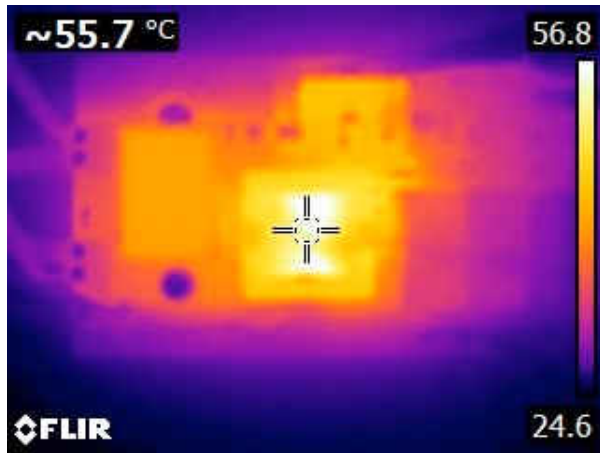

Figure 5-39. Transformer temperature is 55.7°C

Transformer & PCB Temperatures:
 Thermal camera measurement: 55.7 °C
 Thermocouple measurement: 53.9 °C
 Average temperature rise: 54.8 °C
 PCB temperature: 30.6 °C
Transformer T_{RISE} = 53.9 °C - 30.6 °C = 23.3 °C

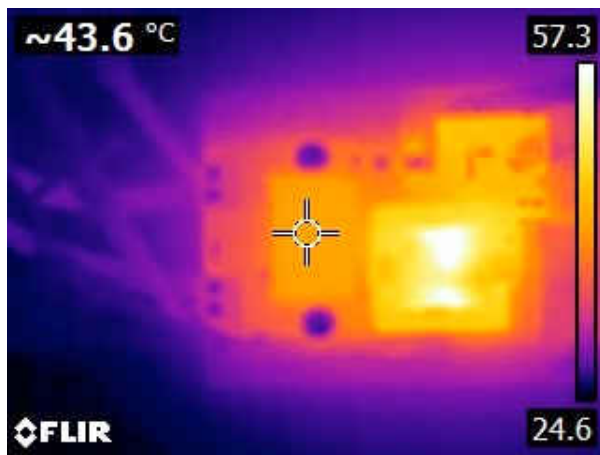

Figure 5-40. Output diode temperature is 43.6°C

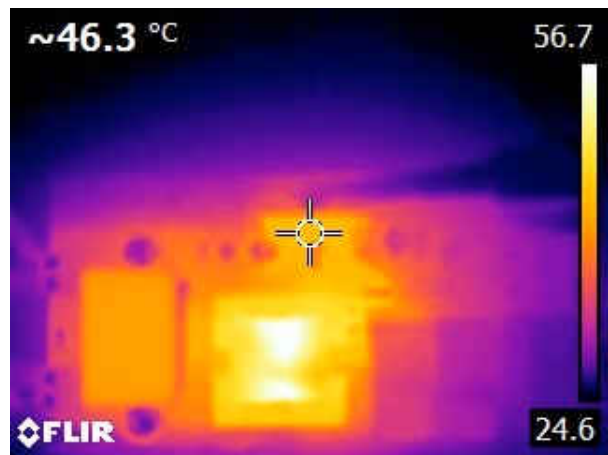

Figure 5-41. MOSFET temperature is 46.3°C

Table 5-2. Thermal Results: VIN = 800 V, 2.7 A, 40 W load

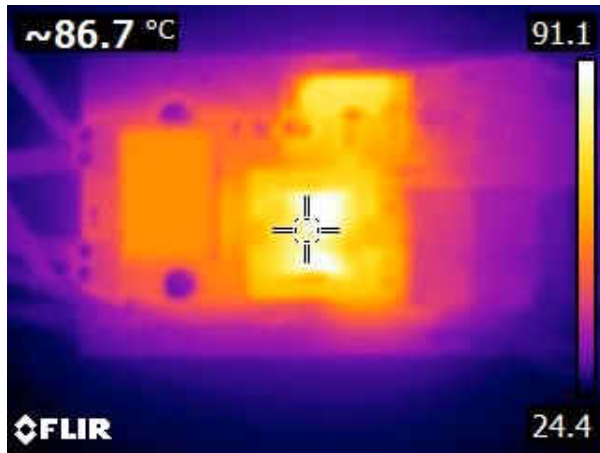

Figure 5-42. Transformer temperature is 86.7°C

Transformer & PCB Temperatures:

- Thermal camera measurement: 86.7 °C
- Thermocouple measurement: 86.2 °C
- Average temperature rise: 86.5 °C
- PCB temperature: 37.6 °C

Transformer $T_{RISE} = 86.5\text{ °C} - 37.6\text{ °C} = 48.9\text{ °C}$

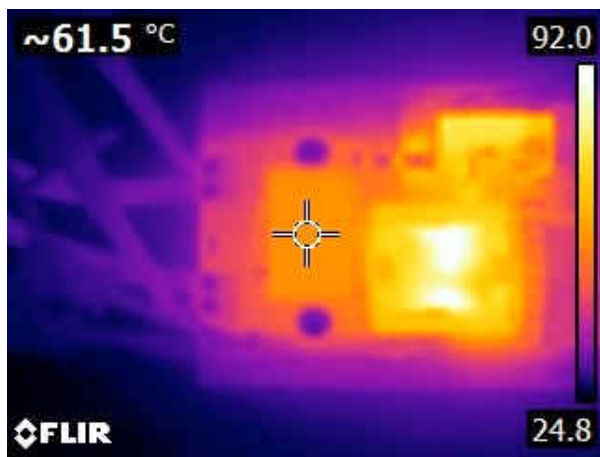

Figure 5-43. Output diode temperature is 61.5°C

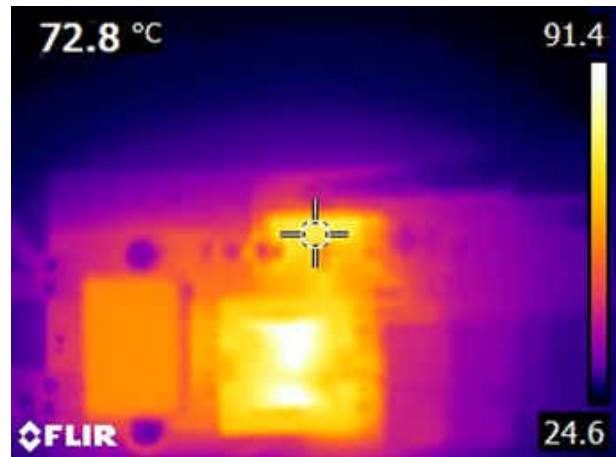

Figure 5-44. MOSFET temperature is 72.8°C

6 Assembly and Printed Circuit Board (PCB)

The UCC28C56EVM-066 is designed using a four-layer PCB. Only traces on the top and bottom layers are used for UCC28C56 connections, so the EVM is basically a two-layer PCB. The two middle layers are dedicated to routing only the test points.

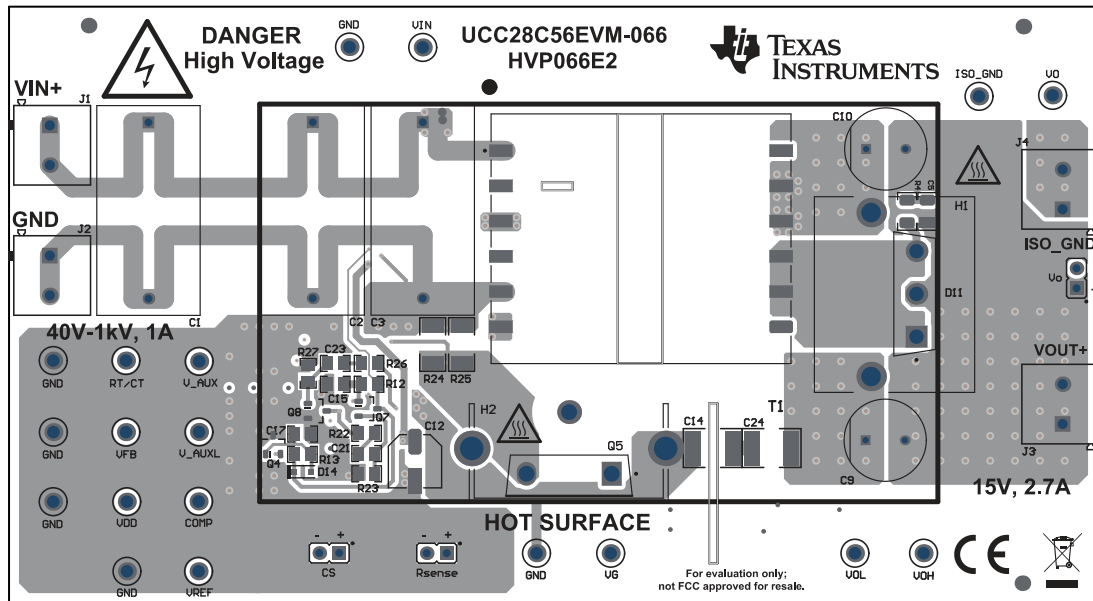

Figure 6-1. UCC28C56EVM-066, PCB Top Layer, Assembly

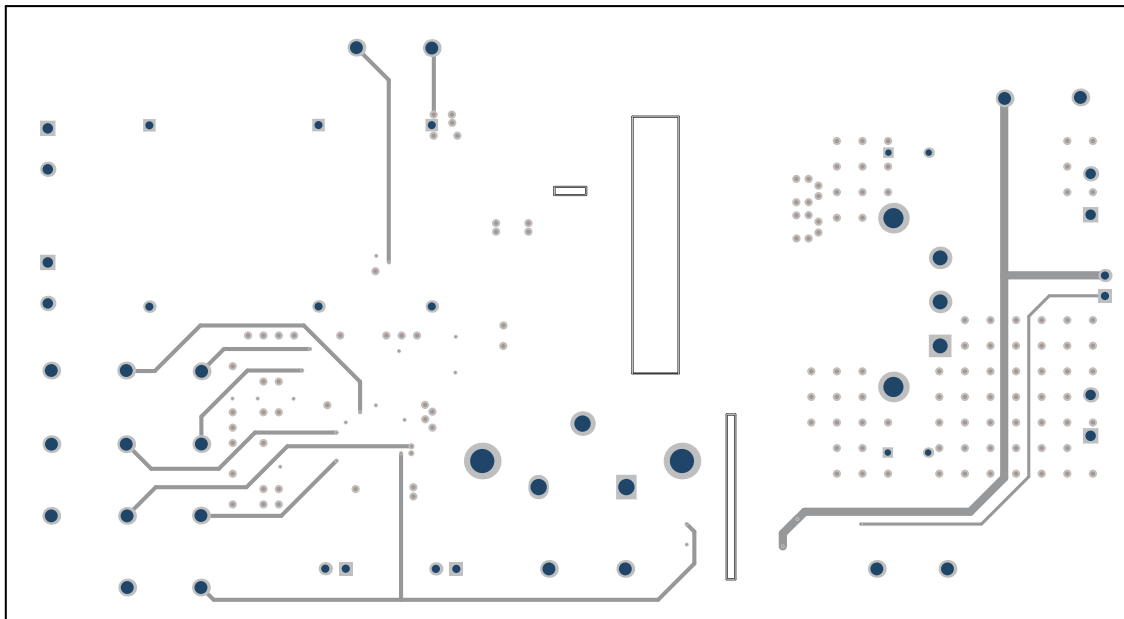

Figure 6-2. UCC28C56EVM-066, Signal Layer 1, Routing for test points only

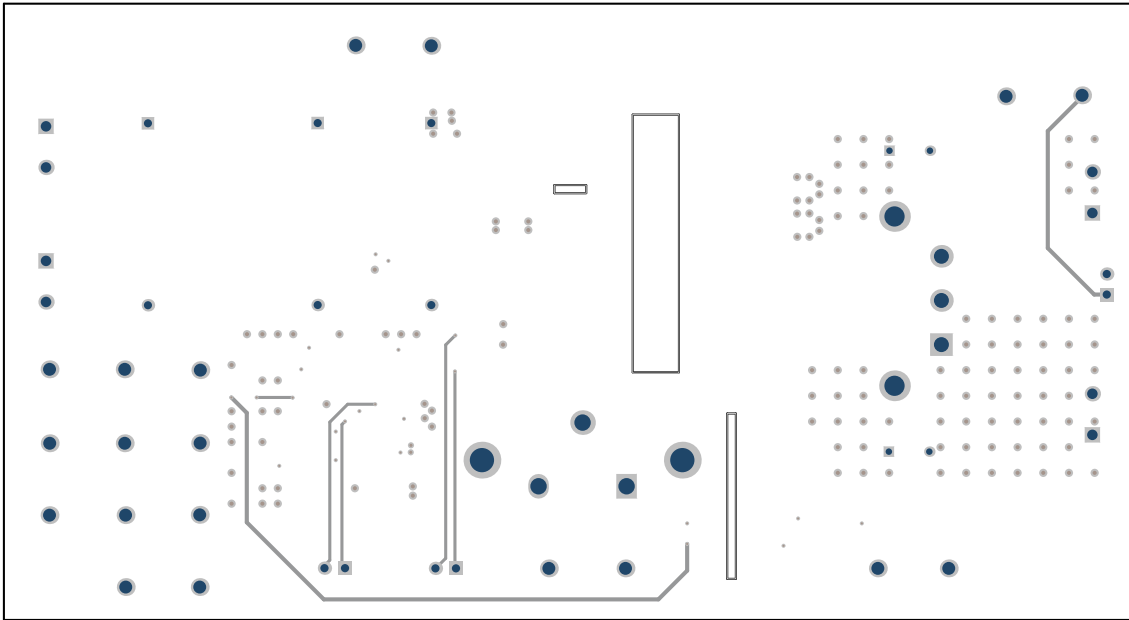

Figure 6-3. UCC28C56EVM-066, Signal Layer 2, Routing for test points only

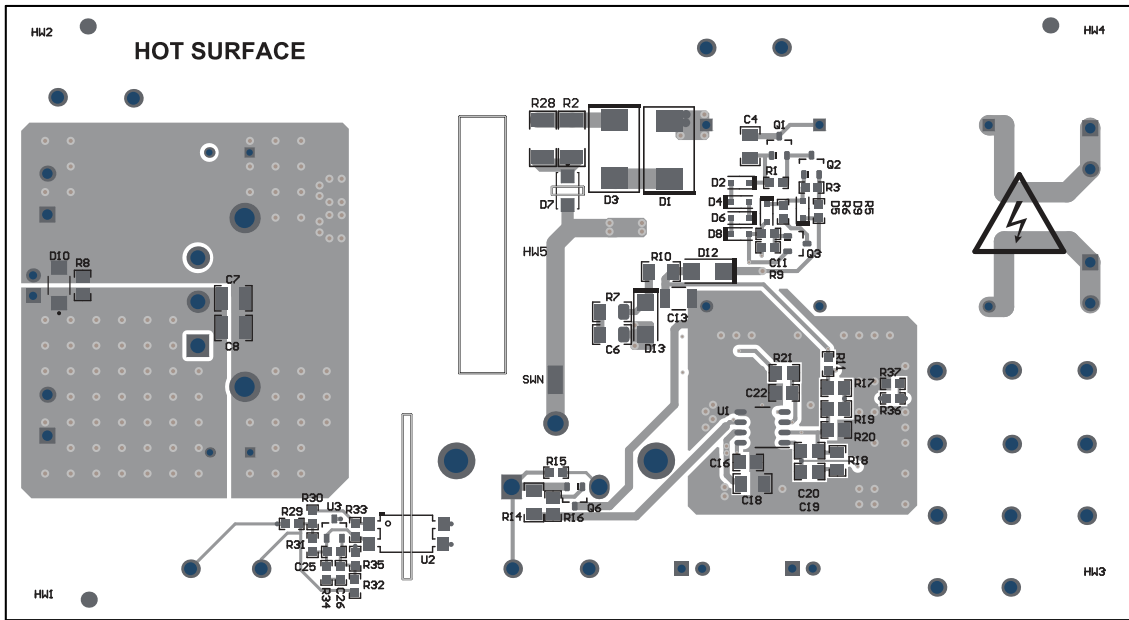

Figure 6-4. UCC28C56EVM-066, PCB Bottom Layer, Assembly (mirrored view)

7 Bill of Materials (BOM)

Table 7-1. UCC28C56EVM-066 Bill of Materials

Item #	Designator	Quantity	Value	Description	PackageReference	PartNumber	Manufacturer	Alternate PartNumber	Alternate Manufacturer
1	!PCB1	1		Printed Circuit Board		UCC28C56EVM-066	Any		
2	C1, C2, C3	3	120nF	Capacitor, Film, 0.12uF, 1600Vdc, Radial, AEC-Q101	RADIAL	R75TN312050H3 J	KEMET		
3	C4	1	1.5pF	CAP, CERM, 1.5 pF, 1000 V, COG/NPO, 1206	1206	1206Y1K01P50D AR	Knowles Syfer	1206N1R5D102C T	Walsin
4	C5	1	1000pF	CAP, CERM, 1000 pF, 630 V, +/- 5%, C0G/NP0, 1206	1206	GRM31B5C2J102 JW01L	MuRata		
5	C7, C8	2	10uF	CAP, CERM, 10 uF, 50 V, +/- 10%, X7R, 1210	1210	CL32B106KBJNN WE	Samsung		
6	C9, C10	2	1mF	CAP, AL, 1000 uF, 25 V, +/- 20%, 0.033 ohm, TH, AEC-Q200	RADIAL	EEU-FK1E102L	Panasonic		
7	C11	1	0.047uF	CAP, CERM, 0.047 uF, 50 V, +/- 10%, X7R, AEC-Q200 Grade 1, 0603	0603	CGA3E2X7R1H4 73K080AA	TDK		
8	C12	1	22uF	CAP, AL, 22 uF, 35 V, +/- 20%, 0.36 ohm, AEC-Q200, SMD	SMT Radial D	35TZV22M6.3X6.1	Rubycon		
9	C13	1	4.7uF	CAP, CERM, 4.7 uF, 50 V, +/- 10%, X7R, AEC-Q200 Grade 1, 1210	1210	CGA6P3X7R1H4 75K250AB	TDK		
10	C14, C24	2	2200pF	CAP, CERM, 2200 pF, 4000 V, +/- 10%, X7R, 1812, AEC-Q200	1812	1812Y4K00222K ST	Knowles Syfer	HV1812Y102KXV ATHV	Vishay Vitramon
11	C15	1	1000pF	CAP, CERM, 1000 pF, 50 V, +/- 10%, X7R, 0805	0805	CC0805KRX7R9 BB102	Yageo America		
12	C16	1	0.1uF	CAP, CERM, 0.1 uF, 50 V, +/- 10%, X7R, 0805	0805	CC0805KRX7R9 BB104	Yageo		
12	C17	1	0.33uF	CAP, CERM, 0.33 uF, 16 V, +/- 10%, X7R, 0805	0805	CL21B334KOCN NNC	Samsung		
13	C18	1	1uF	CAP, CERM, 1 uF, 50 V, +/- 10%, X7R, 1206	1206	UMK316B7105KL HT	Taiyo Yuden		
14	C19	1	0.022uF	CAP, CERM, 0.022 uF, 50 V, +/- 10%, X7R, 0805	0805	CC0805KRX7R9 BB223	Yageo America		
15	C20, C22	2	100pF	CAP, CERM, 100 pF, 50 V, +/- 5%, C0G/NP0, 0805	0805	CC0805JRNPO9 BN101	Yageo America		
16	C21	1	2.2uF	CAP, CERM, 2.2 uF, 25 V, +/- 10%, X7R, AEC-Q200 Grade 1, 0805	0805	GCM21BR71E22 5KA73L	MuRata		
17	C23	1	22pF	CAP, CERM, 22 pF, 50 V, +/- 5%, C0G/NP0, 0805	0805	CC0805JRNPO9 BN220	Yageo		
18	D1, D3	2	160V	Diode, TVS, Uni, 160V, 259VC, AEC-Q101, SMC	SMC	SMCJ160AHE3_A/I	Vishay Semiconductor	SMCJ160A-TP	Micro Commercial Co
19	D2, D4, D6, D8	4	130V	Diode, Zener, 130 V, 200 mW, SOD-323F, AEC-Q101	SOD-323F	UDZLVFHTe-171 30	Rohm		
20	D5	1	22V	Diode, Zener, 22 V, 5%, 200 mW, SOD-323, AEC-Q101	SOD-323	BZX384C22-HE3-18	Vishay Semiconductor	SZMM3Z22VST1 G	ON Semi
21	D7	1	1.6kV	Diode, Avalanche, 1.6kV, 1.5A, AEC-Q101, SMA	DO-214AC	BYG10YHE3_A/I	Vishay		
22	D9	1	18V	Diode, Zener, 18 V, 4%, 200 mW, AEC-Q101, SOD-323	SOD-323	GDZ18B-HE3-18	Vishay	DDZ9705S-7	Diodes, Inc.
23	D10	1	18V	Diode, Zener, 18 V, 1 W, ±6.39%, SMT, PMDTM, AEC-Q101	SOD-128	PDZVTFTR18B	ROHM	ZMY18-GS18	Vishay Semiconductor
24	D11	1	200V	Diode Array, Comon Cathode, Schottky, 200V, 40A, AEC-Q101, TO-247	TO-247AD	MBR40200PTH	Taiwan Semiconductor	DSSK60-02AR / MBR90200WT	IXYS / SMC Diode Solutions
25	D12	1	60V	Diode, Schottky, 60 V, 1 A, SMA, AEC-Q101	SMA	SS16HE3_B/H	Vishay Semiconductor	SS16-AU_R1_000A1	Panjit International
26	D13	1	200V	Diode, Standard Recovery, 200 V, 1 A, SMA, AEC-Q101	SMA	S1DHE3_A/H	Vishay Semiconductor		
27	D14	1	40V	Diode, Schottky, 30 V, 30 mA, AEC-Q101, SOD-323	SOD-323	SD101CWS-HE3-08	Vishay	RB501V-40-TP	Micro Commercial Co
28	H1	1	Black Anodized	Heat Sink TO-247 Aluminum 5.0W @ 60°C Board Level, Vertical	PTH_HEATSINK_2 OMM47_25MM0	C247-025-1AE	Ohmite	C247-025-1VE	Ohmite
29	HW1, HW2, HW3, HW4, HW5	5				SJ61A6	3M		
30	J1, J2, J3, J4	4		Terminal Block, 5.08 mm, 2x1, TH	2POS Terminal Block	1715721	Phoenix Contact		
31	KIT1	1		Mounting Kit, DISCARD the TO_220 thermal pad, Use SILPAD1 instead		4880SG	Aavid Thermalloy		

Table 7-1. UCC28C56EVM-066 Bill of Materials (continued)

Item #	Designator	Quantity	Value	Description	PackageReference	PartNumber	Manufacturer	Alternate PartNumber	Alternate Manufacturer
32	Q1, Q2	2	600V	MOSFET, N-CH, Depletion Mode, 600 V, 0.021 A, SOT-23, AEC-Q101	SOT-23	BSS126H6906XT SA1	Infineon Technologies		
33	Q3	1	60V	MOSFET, N-CH, 60 V, 0.19 A, SOT-23	SOT-23	NX7002AK,215	Nexperia USA Inc		
34	Q4	1	60V	Transistor, PNP, 60 V, 0.6 A, SOT-23, AEC-Q101	SOT-23	PMBT2907A,235	Nexperia USA Inc		
35	Q5	1		MOSFET, N-Ch, SiC, 1700V, 5A, AEC-Q101, TO-247	TO-247-3	SCT1000N170AG	ST Microelectronics	G2R1000MT17D / C2M1000170D	GeneSIC / Wolfspeed
36	Q6	1	60V	Transistor, PNP, 60 V, 2 A, SOT-23, AEC-Q101	SOT-23	PBSS5350THR	Nexperia USA Inc		
37	Q7, Q8	2	40V	Transistor, NPN, 40 V, 0.2 A, SOT-23, AEC-Q101	SOT-23	MMBT3904,215	Nexperia USA Inc		
38	R1, R3	2	1.0Meg	RES, 1.0 M, 5%, 0.1 W, AEC-Q200 Grade 0, 0603	0603	CRCW06031M00 JNEA	Vishay-Dale		
39	R2, R28	2	62	RES, 62, 5%, 0.75 W, AEC-Q200 Grade 0, 2010	2010	CRCW201062R0 JNEF	Vishay-Dale	Panasonic	ERJ-12SF64R9U
40	R4	1	100	RES, 100, 1%, 0.25 W, AEC-Q200 Grade 0, 1206	1206	CRCW1206100R FKEA	Vishay-Dale		
41	R5	1	1.00k	RES, 1.00 k, 1%, 0.1 W, AEC-Q200 Grade 0, 0603	0603	CRCW06031K00 FKEA	Vishay-Dale		
42	R6, R9	2	10.0k	RES, 10.0 k, 1%, 0.1 W, AEC-Q200 Grade 0, 0603	0603	CRCW060310K0 FKEA	Vishay-Dale		
43	R8	1	100k	RES, 100 k, 1%, 0.125 W, AEC-Q200 Grade 0, 0805	0805	CRCW0805100K FKEA	Vishay-Dale		
44	R10	1	0	RES, 0, 5%, 0.25 W, AEC-Q200 Grade 0, 1206	1206	CRCW12060000 Z0EA	Vishay-Dale		
45	R11	1	10.0	RES, 10.0, 1%, 0.1 W, AEC-Q200 Grade 0, 0603	0603	CRCW060310R0 FKEA	Vishay-Dale		
46	R12	1	40.2k	RES, 40.2 k, 1%, 0.125 W, AEC-Q200 Grade 0, 0805	0805	ERJ-6ENF4022V	Panasonic		
47	R13	1	20.0k	RES, 20.0 k, 1%, 0.125 W, AEC-Q200 Grade 0, 0805	0805	CRCW080520K0 FKEA	Vishay-Dale		
48	R14	1	39.2	RES, 39.2, 1%, 0.25 W, AEC-Q200 Grade 0, 1206	1206	CRCW120639R2 FKEA	Vishay-Dale		
49	R15	1	44.2k	RES, 44.2 k, 1%, 0.1 W, AEC-Q200 Grade 0, 0603	0603	CRCW060344K2 FKEA	Vishay-Dale		
50	R16, R27	2	127	RES, 127, 1%, 0.125 W, AEC-Q200 Grade 0, 0805	0805	CRCW0805127R FKEA	Vishay-Dale		
51	R17	1	2.55k	RES, 2.55 k, 1%, 0.125 W, AEC-Q200 Grade 0, 0805	0805	CRCW08052K55 FKEA	Vishay-Dale		
52	R18	1	324k	RES, 324 k, 1%, 0.125 W, AEC-Q200 Grade 0, 0805	0805	CRCW0805324K FKEA	Vishay-Dale		
53	R19	1	20.0k	RES, 20.0 k, 1%, 0.125 W, AEC-Q200 Grade 0, 0805	0805	ERJ-6ENF2002V	Panasonic		
54	R20	1	3.48k	RES, 3.48 k, 1%, 0.125 W, AEC-Q200 Grade 0, 0805	0805	CRCW08053K48 FKEA	Vishay-Dale		
55	R21	1	1.00k	RES, 1.00 k, 1%, 0.125 W, AEC-Q200 Grade 0, 0805	0805	CRCW08051K00 FKEA	Vishay-Dale		
56	R22	1	4.02k	RES, 4.02 k, 1%, 0.125 W, AEC-Q200 Grade 0, 0805	0805	CRCW08054K02 FKEA	Vishay-Dale		

Table 7-1. UCC28C56EVM-066 Bill of Materials (continued)

Item #	Designator	Quantity	Value	Description	PackageReference	PartNumber	Manufacturer	Alternate PartNumber	Alternate Manufacturer
57	R23	1	15.0k	RES, 15.0 k, 1%, 0.125 W, AEC-Q200 Grade 0, 0805	0805	CRCW080515K0 FKEA	Vishay-Dale		
58	R24, R25	2	0.91	RES, 0.91, 1%, 0.75W, 2010	2010	RL73H2HR91FTE	TE Connectivity		
59	R26	1	2.00k	RES, 2.00 k, 1%, 0.125 W, AEC-Q200 Grade 0, 0805	0805	CRCW08052K00 FKEA	Vishay-Dale		
60	T1	1		Transformer, PRI 40-1000V, SEC 16V 1.2A, AUX 20V 35mA	XFRMR_SMD_38M M3_31MM9	ZB1432-CL	Coilcraft		
61	THERM PAD 1	1	9200V	Thermal Pad for Q5 w/ KIT1, 26.7 mm x 21.6 mm x 0.076mm, 0.107degC-in2/W		CD-02-05-264	Wakefield-Vette		
62	THERM PAD 2	1	9200V	Thermal Pad for D11 (no hole), 24.1mm x 19.0mm x 0.076mm, , 0.107degC-in2/W		CD-02-05-247-N	Wakefield-Vette		
63	TP1	1		Test Point, Multipurpose, Red, TH	Red Multipurpose Testpoint	5010	Keystone		
64	TP2, TP3, TP4, TP5, TP6, TP8, TP10	7		Test Point, Multipurpose, Black, TH	Black Multipurpose Testpoint	5011	Keystone		
65	TP7	1		Test Point, Multipurpose, Yellow, TH	Yellow Multipurpose Testpoint	5014	Keystone		
66	TP9	1		PC Test Point, SMT	PC Test Point, SMT	5017	Keystone		
67	TP11, TP12, TP13, TP14, TP15, TP16, TP17, TP18	8		Test Point, Multipurpose, White, TH	White Multipurpose Testpoint	5012	Keystone		
68	U1	1		Automotive BiCMOS Low-Power Current Mode PWM Controller, SOIC-8, AEC-Q101	D0008A	UCC28C56QDRQ 1	Texas Instruments		
69	C6	0	1000pF	CAP, CERM, 1000 pF, 630 V, +/- 5%, C0G/NP0, 1206	1206	GRM31B5C2J102 JW01L	MuRata		
70	C25	0	0.33uF	CAP, CERM, 0.33 uF, 50 V, +/- 10%, X7R, AEC-Q200 Grade 1, 0603	0603	CGA3E3X7R1H3 34K080AB	TDK		
71	C26	0	0.22uF	CAP, CERM, 0.22 uF, 25 V, +/- 10%, X7R, 0603	0603	C1608X7R1E224 K080AC	TDK		
72	FID1, FID2, FID3, FID4, FID5, FID6	0		Fiducial mark. There is nothing to buy or mount.	Fiducial	N/A	N/A		
73	J5, J6, J7	0		Header, 100mil, 2x1, Gold, TH	Sullins 100mil, 1x2, 230 mil above insulator	PBC02SAAN	Sullins Connector Solutions		
74	R7	0	100	RES, 100, 1%, 0.25 W, AEC-Q200 Grade 0, 1206	1206	CRCW1206100R FKEA	Vishay-Dale		
75	R29	0	10.0	RES, 10.0, 1%, 0.1 W, AEC-Q200 Grade 0, 0603	0603	CRCW060310R0 FKEA	Vishay-Dale		
76	R30	0	2.00k	RES, 2.00 k, 1%, 0.1 W, AEC-Q200 Grade 0, 0603	0603	ERJ3EKF2001V	Panasonic		

Table 7-1. UCC28C56EVM-066 Bill of Materials (continued)

Item #	Designator	Quantity	Value	Description	PackageReference	PartNumber	Manufacturer	Alternate PartNumber	Alternate Manufacturer
77	R31	0	1.24k	RES, 1.24 k, 1%, 0.1 W, AEC-Q200 Grade 0, 0603	0603	CRCW06031K24 FKEA	Vishay-Dale		
78	R32	0	12.4k	RES, 12.4 k, 1%, 0.1 W, 0603	0603	RC0603FR-0712 K4L	Yageo		
79	R33, R37	0	1.00k	RES, 1.00 k, 1%, 0.1 W, 0603	0603	RC0603FR-071K L	Yageo		
80	R34	0	6.81k	RES, 6.81 k, 1%, 0.1 W, 0603	0603	RC0603FR-076K 81L	Yageo		
81	R35	0	2.43k	RES, 2.43 k, 1%, 0.1 W, 0603	0603	RC0603FR-072K 43L	Yageo		
82	R36	0	0	RES, 0, 5%, 0.1 W, 0603	0603	RC0603JR-070R L	Yageo		
83	TP19, TP20	0		Test Point, Multipurpose, Yellow, TH	Yellow Multipurpose Testpoint	5014	Keystone		
84	U2	0		Optocoupler, 5 kV, 80-160% CTR, SMT	DIP-4L Gullwing	FOD817ASD	Fairchild Semiconductor		
85	U3	0		Automotive Catalog Adjustable Precision Shunt Regulator, 34 ppm / degC, 100 mA, -40 to 125 degC, 3-pin SOT-23 (DBZ), Green (RoHS & no Sb/Br)	DBZ0003A	TL431AQBZRQ 1	Texas Instruments		

Notes:

Unless otherwise noted in the Alternate PartNumber and/or Alternate Manufacturer columns, all parts may be substituted with equivalents.

8 Revision History

NOTE: Page numbers for previous revisions may differ from page numbers in the current version.

Changes from Revision * (June 2022) to Revision A (July 2022)	Page
• Updated EVM images.....	3
• Changed test results of efficiency.....	4
• Updated efficiency images.....	9
• Updated thermal images.....	26
• Removed heatsink H2 from the SiC MOSFET.....	32

IMPORTANT NOTICE AND DISCLAIMER

TI PROVIDES TECHNICAL AND RELIABILITY DATA (INCLUDING DATA SHEETS), DESIGN RESOURCES (INCLUDING REFERENCE DESIGNS), APPLICATION OR OTHER DESIGN ADVICE, WEB TOOLS, SAFETY INFORMATION, AND OTHER RESOURCES "AS IS" AND WITH ALL FAULTS, AND DISCLAIMS ALL WARRANTIES, EXPRESS AND IMPLIED, INCLUDING WITHOUT LIMITATION ANY IMPLIED WARRANTIES OF MERCHANTABILITY, FITNESS FOR A PARTICULAR PURPOSE OR NON-INFRINGEMENT OF THIRD PARTY INTELLECTUAL PROPERTY RIGHTS.

These resources are intended for skilled developers designing with TI products. You are solely responsible for (1) selecting the appropriate TI products for your application, (2) designing, validating and testing your application, and (3) ensuring your application meets applicable standards, and any other safety, security, regulatory or other requirements.

These resources are subject to change without notice. TI grants you permission to use these resources only for development of an application that uses the TI products described in the resource. Other reproduction and display of these resources is prohibited. No license is granted to any other TI intellectual property right or to any third party intellectual property right. TI disclaims responsibility for, and you will fully indemnify TI and its representatives against, any claims, damages, costs, losses, and liabilities arising out of your use of these resources.

TI's products are provided subject to [TI's Terms of Sale](#) or other applicable terms available either on ti.com or provided in conjunction with such TI products. TI's provision of these resources does not expand or otherwise alter TI's applicable warranties or warranty disclaimers for TI products.

TI objects to and rejects any additional or different terms you may have proposed.

Mailing Address: Texas Instruments, Post Office Box 655303, Dallas, Texas 75265
Copyright © 2022, Texas Instruments Incorporated