

## ***Designing a UCD3138 Controlled Interleaved PFC***

*Bosheng Sun*
*High Performance Isolated*

### **ABSTRACT**

The UCD3138[1] is a digital power supply controller from Texas Instruments offering superior levels of integration and performance in a single chip solution. The flexible nature of the UCD3138 makes it suitable for a wide variety of power conversion applications. In addition, multiple peripherals inside the device have been specifically optimized to enhance the performance of ac/dc applications such as a power factor correction (PFC).

The UCD3138 is a fully programmable solution offering customers complete control of their application. However, the use of digital controllers in PFC design brings new challenges to many analog designers in their effort to change the design from the analog space to its new digital environment. This application note gives a step by step guidance of how to design a UCD3138 controlled interleaved PFC. It covers hardware interface, voltage loop and current loop implementation, protection, firmware structure, internal state machine, as well as some advanced features. Finally, a graphical user interface (GUI) and how to tune a new designed PFC are presented. For single phase or bridgeless PFC design, please refer to application note [2] and [3].

### **Contents**

<b>1 Overview .....</b>	<b>3</b>
1.1 Block Diagram .....	3
1.2 Signal Conditioning and Interface .....	4
<b>2 Voltage Loop.....</b>	<b>4</b>
2.1 Overview.....	4
2.2 Firmware Implementation of PI Controller .....	4
<b>3 Current Loop.....</b>	<b>6</b>
3.1 Overview.....	6
3.2 Multiplier Gain $K_m$ .....	6
3.3 Vin Sensing and Rectification .....	7
3.4 Calculate $V_{in\_rms}^2$ .....	7
3.5 Calculate Vin Feed Forward .....	8
3.6 Calculate Average Current Reference.....	9
3.7 Translate average reference to instantaneous reference .....	9
3.8 Current Feed Back Front End Configuration .....	11
3.9 Current Loop Filter Configuration .....	11
3.10 DPWM Configuration .....	13
<b>4 System Protection.....</b>	<b>15</b>
4.1 Software OVP Protection.....	15
4.2 Hardware OVP Protection .....	15
4.3 Cycle by Cycle Current Protection.....	16
<b>5 Advanced Features .....</b>	<b>16</b>
5.1 Frequency Dithering .....	16
5.2 AC Drop Detection.....	17
5.3 X-CAP Reactive Current Compensation.....	18

5.4 Current Balancing .....	18
<b>6 Firmware structure .....</b>	<b>19</b>
6.1 Background Loop .....	19
6.2 Standard Interrupt Loop (IRQ) .....	20
6.2.1 Tasks Distribution State Machine .....	21
6.2.2 PFC State Machine .....	21
6.3 Fast Interrupt (FIQ) .....	23
<b>7 Graphic User Interface (GUI) .....</b>	<b>23</b>
<b>8 PFC Tuning and THD Reduction .....</b>	<b>25</b>
<b>Reference: .....</b>	<b>25</b>

### Figures

<b>Figure 1. UCD3138 controlled interleaved PFC block diagram .....</b>	<b>3</b>
<b>Figure 2. Current loop .....</b>	<b>6</b>
<b>Figure 3. Sensed current waveform at continuous conduction mode .....</b>	<b>9</b>
<b>Figure 4. Sensed current waveform at discontinuous conduction mode .....</b>	<b>9</b>
<b>Figure 5. AC Drop Detection .....</b>	<b>17</b>
<b>Figure 6. Firmware Structure .....</b>	<b>19</b>
<b>Figure 7. PFC State Machine .....</b>	<b>22</b>
<b>Figure 8. Monitor PFC Operating Status .....</b>	<b>24</b>
<b>Figure 9. Configure PFC Operation Setpoints .....</b>	<b>24</b>
<b>Figure 10. Tune PFC Control Loop .....</b>	<b>25</b>

# 1 Overview

## 1.1 Block Diagram

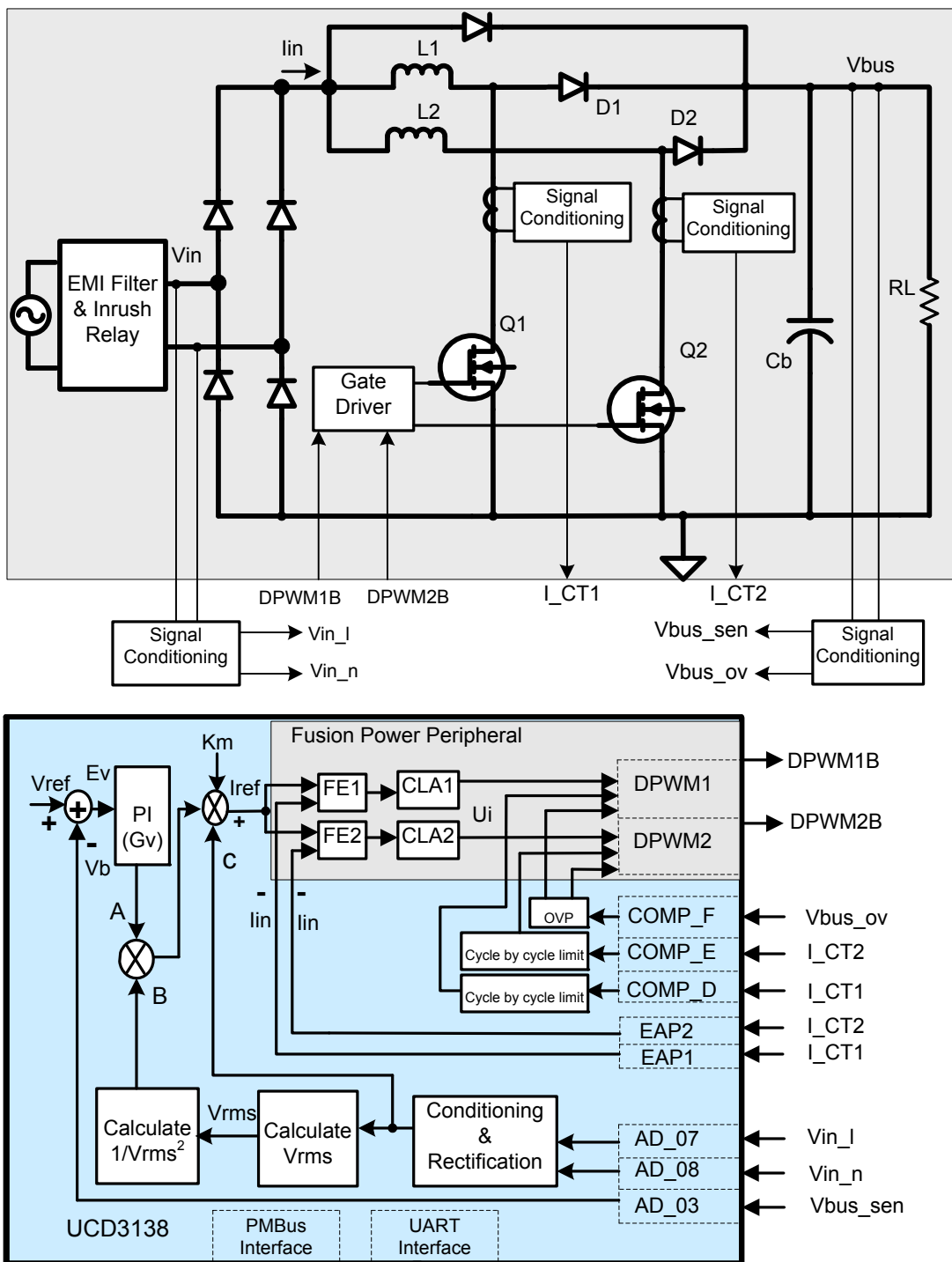

Figure 1. UCD3138 controlled interleaved PFC block diagram

Figure 1 is an example of block diagram of an interleaved PFC controlled by UCD3138. The input voltage  $V_{in}$  line and neutral are sensed separately by two ADC channels AD\_07 and AD\_08. PFC output voltage  $V_{bus\_sen}$  is sensed by another ADC channel AD\_03. In addition, a separate  $V_{out}$  sensing circuit is connect to an on chip analog comparator COMP\_F for over voltage protection (OVP). Two current transformers are used to sense the MOSFET instantaneous current and their output I\_CT1 and I\_CT2 are connected to EAP1 and EAP2 respectively for current loop control. Two control loops run individually, each generates a PWM output to control one of the phase. In addition, I\_CT1 and I\_CT2 are also connected to two on chip analog comparators COMP\_E and COMP\_D for cycle-by-cycle current protection.

Average current mode control is used for input current regulation: current reference is calculated based on  $V_{in}$ , voltage loop output and input voltage feed forward. This averaged current reference is then translated to instantaneous signal as if they were sensed at the middle of CT output. The translated reference is then compared to the middle point value of CT output, the error goes through a 2-pole 2-zero digital compensator, a PWM signal is generated based on the compensator output to control the PFC.

It needs to be mentioned here that the above configuration accommodates with TI's PFC evaluation board PWR026. It is not necessary to follow this configuration. For example, I\_CT1/I\_CT2 can be connected to a different EPA channel, different CLAs can be used for current loop compensation, and PFC can be driven by different DPWM outputs also. However, in order to maximize source code reuse and reduce design time it is recommended to use a configuration similar to PWR026.

## 1.2 Signal Conditioning and Interface

For each input signal to UCD3138, its magnitude should accommodate the measurement range of UCD3138. In UCD3138, the ADC measurement range is 0 – 2.5V, the error ADC measurement range is 0 - 1.6V, the analog comparator range is 0 – 2.5V. On the other hand, to have the best signal-to-noise ration, the input signal should be as big as possible. For these reason, the signal conditioning for each input signal should follow the subsequent guidelines:

- For  $V_{in}$ , the voltage divider:  $K_{vin} \leq \frac{2.5}{\sqrt{2} * V_{in\_max}}$
- For  $V_{out}$ , the voltage divider:  $K_{vout} \leq \frac{2.5}{V_{out\_max}}$
- For current transformer: the maximum middle point of I\_CT1 and I\_CT2 should less than 1.6V, and the maximum peak value should less than 2.5V.

## 2 Voltage Loop

### 2.1 Overview

Since the speed constraints on the voltage loop bandwidth are typically low, it can easily be implemented by pure firmware. As shown in Figure 1.  $V_{out\_sen}$  is sensed by a 12-bit ADC. An error signal is calculated based on the target output voltage and then processed by a proportional-integral (PI) controller. The output of this PI controller will take part in the current reference calculation.

To meet the load transient response requirement, a non-linear PI gain is used. When the voltage error exceeds a threshold, a larger PI gain is used to do the loop calculation.

### 2.2 Firmware Implementation of PI Controller

Following is the code example for this nonlinear PI controller. Two different gains are used in this example. If the load transient response still is not meet spec, a third or forth gain can be added.

All the codes in this application note are just examples of how to implement a specific function, it does not contain the variable definitions and how the function gets called. Although plenty of comments are provided to explain how it works, there may still exist unclearness. To better understand the code, please refer to PWR026 PFC EVM source code for details.

```

inline int32 proportional_integral(int32 error) //error is difference between ADC value and reference
{
    int32 output, steady_state_error;

    if( abs(error) < iv.pis.nl_threshold) //if error in steady state range
    {
        steady_state_error = iv.vbus_target - (iv.vbus_filtered >> 6);
        iv.pis.p = iv.pis.kp * steady_state_error;
        iv.pis.i = iv.pis.i + (iv.pis.ki * steady_state_error);
    }
    else
    {
        //non-linear gain for Voltage loop
        iv.pis.p = iv.pis.kp_nl * error;//Q15*Q12
        iv.pis.i = iv.pis.i + (iv.pis.ki_nl * error);
    }

    if(iv.ac_drop_recovery_not_complete)
    {
        if(((error < 0) && (iv.pis.i > 0)) || ((error > 0) && (iv.pis.i < 0)))
        {
            iv.pis.i = 0; //reset the integral just when AC voltage has restored
            iv.ac_drop_recovery_not_complete = 0; //AC drop recovery completed
        }
    }

    if(iv.pis.i > PI_I_HIGH_LIMIT) //clamp integrator
    {
        iv.pis.i = PI_I_HIGH_LIMIT;
    }
    else if (iv.pis.i < PI_I_LOW_LIMIT)
    {
        iv.pis.i = PI_I_LOW_LIMIT;
    }

    output = (iv.pis.p + iv.pis.i) >> 12; //scale for Q15 from Q15 coefficients and Q12 from ADC

    if(output > PI_OUTPUT_HIGH_LIMIT) //clamp PI output
    {
        output = PI_OUTPUT_HIGH_LIMIT;
    }
    else if (output < PI_OUTPUT_LOW_LIMIT)
    {
        output = PI_OUTPUT_LOW_LIMIT;
    }

    iv.pis.output = output;
    return output;
}
    
```

### 3 Current Loop

#### 3.1 Overview

The PFC current loop is used to regulate the inductor current so that the input current will follow the input voltage. To do this, the current reference, which takes the same shape of input voltage, needs to be calculated first. For average current mode controlled PFC, the average current reference is calculated as:

$$I_{ref} = K_m * A * B * C \tag{1}$$

while:

$K_m$ : multiplier gain

A: Voltage loop output

B:  $1/V_{in\_rms}^2$

C: sensed input voltage  $K_{vin} * V_{in}$

However, for interleaved PFC with CT sensing, because the current transformer is placed right above the switch, it only senses the switching current, which is only the rising part of the inductor current. So the calculated average current reference needs to be translated to instantaneous current signal as if it is sensed by CT.

Once the current reference is calculated, the corresponding function blocks in the chip need to be configured to close the loop. There are 3 major hardware blocks for each of the current loops: Front End, Filter, and DPWM. These blocks will be introduced one by one.



Figure 2. Current loop

#### 3.2 Multiplier Gain $K_m$

The multiplier gain  $K_m$  is defined as follows:

From (1),

$$I_{ref} = K_m * A * C * B = K_m (U_v)(V_{in} * K_{vin}) / V_{rms}^2 \tag{2}$$

where,

$U_v$  : voltage loop output

$V_{rms}$  : RMS voltage of digitized input voltage

$K_{vin}$  : Input voltage divider

For digital implementation, the voltage signals in (2) are digitized, a suitable fixed-point notation is chosen so that each signal is normalized with the maximum value equals to 1. For maximum power output, at minimum  $V_{in}$ , the voltage controller output and the reference current command will be at their maximum values,  $U_{vmax}$  and  $I_{ref\_max}$  respectively. Since  $I_{ref}$  and  $U_v$  are calculated in per unit, their maximum values are,  $I_{ref\_max} = 1$ ,  $U_{vmax} = 1$ . Therefore,

$$K_m = I_{ref\_max} \left[ \frac{V_{rms(min)}^2}{V_{min(pk)} K_{vin} U_{vmax}} \right] = \frac{V_{rms(min)}^2}{V_{min(pk)} K_{vin}} \tag{3}$$

For sine wave input, this can be written as,

$$K_m = \frac{K_{vin}^2 V_{\min(pk)}^2}{2V_{\min(pk)} K_{vin}} = 0.5 K_{vin} V_{\min(pk)} \quad (4)$$

### 3.3 Vin Sensing and Rectification

The input AC voltage is measured before the bridge rectifier by separately sensing the line and neutral voltages with referencing to internal power ground, it is then rectified by firmware.

```
inline void rectify_vac(void)
{
    if(iv.adc_raw[AC_L_CHANNEL] > iv.adc_raw[AC_N_CHANNEL]) //this is the cycle for line
    {
        iv.vin_raw = iv.adc_raw[AC_L_CHANNEL] - iv.adc_raw[AC_N_CHANNEL];
        iv.positive = 1; //tell other functions that this is positive cycle
    }
    else //cycle for neutral
    {
        iv.vin_raw = iv.adc_raw[AC_N_CHANNEL] - iv.adc_raw[AC_L_CHANNEL];
        iv.positive = 0; //tell other functions that this is negative cycle
    }
    iv.vin_sum = iv.vin_raw + iv.vin_sum - (iv.vin_sum >> 2);
    iv.vin_filtered = iv.vin_sum >> 2; //filtered vin measurement
}
```

### 3.4 Calculate $V_{in\_rms}^2$

The RMS value is defined as:

$$V_{rms}^2 = \frac{1}{T_{ac}} * \int_0^{T_{ac}} V(t)^2 dt \quad (5)$$

In discrete format:

$$V_{rms}^2 = \frac{\sum V(n)^2}{N} \quad (6)$$

Vin is sampled every 20µs, then the sampled Vin is squared and accumulated in each AC cycle. The RMS value is calculated by divide the number of accumulator.

First, calculate  $V(n)^2$

```
iv.vin_squared = (iv.vin_filtered * iv.vin_filtered) >> 9;
```

Then, calculate sum

```
//sum V(n)2 for the negative cycle
inline void accumulate_negative_cycle_values()
{
    iv.negative_vin_squared_accumulate = iv.vin_squared + iv.negative_vin_squared_accumulate;
}

// sum V(n)2 for the positive cycle
inline void accumulate_positive_cycle_values()
{
```

```

    iv.positive_vin_squared_accumulate = iv.vin_squared + v.positive_vin_squared_accumulate;
}

```

Finally, calculate  $V_{in\_rms}^2$

*//calculate  $V_{in\_rms}^2$  for the negative cycle*

```

inline void store_negative_cycle_values(void)
{
    iv.vin_squared_average = iv.negative_vin_squared_accumulate / iv.negative_cycle_counter;
    iv.vin_squared_for_ac_drop = iv.vin_squared_average;
}

```

*//calculate  $V_{in\_rms}^2$  for the positive cycle*

```

inline void store_positive_cycle_values(void)
{
    iv.vin_squared_average = iv.positive_vin_squared_accumulate / iv.positive_cycle_counter;
    iv.vin_squared_for_ac_drop = iv.vin_squared_average;
}

```

### 3.5 Calculate $V_{in}$ Feed Forward

The following function is used to calculate voltage feed forward  $K_m * B$

$K_m$ : multiplier gain

$B$ :  $1/V_{in\_rms}^2$

```

inline void voltage_feed_forward(void) //calculate  $K_m/V_{rms}^2$ 
{
    if(iv.vin_squared_average < VAC_MIN_OFF_SQ_AVG) //if VAC is below normal operation range
    {
        iv.vff_multiplier = K_FEED_FORWARD / VAC_MIN_OFF_SQ_AVG;
        //Q30/Q15 = Q15 limit to minimum operating voltage to avoid overflow
    }
    else //here if vac is within range
    {
        if(abs(iv.vin_squared_average -
            (iv.vin_squared_slow_average >> VRECT_SQUARED_SLOW_AVERAGE_SHIFT)) >
            (iv.vin_squared_slow_average >> (VRECT_SQUARED_SLOW_AVERAGE_SHIFT + 4)))
            //compares difference between fast and slow VAC values to a percentage of the slow value.
            //instead of multiplying the slow value times a constant, it uses a shift. So a shift of +4, for
            //example = 1/16 or .0625% of the slow value.
            //so the code below is executed if the difference between fast and slow values is greater
            //than the percentage. It uses the fast value.
            {
                iv.vff_multiplier = K_FEED_FORWARD / iv.vin_squared_average;
            }
        else //here if the fast and slow values are close - use the slow value.
        {
            if(iv.vin_squared_slow_average < (VAC_MIN_OFF_SQ_AVG <<
                VRECT_SQUARED_SLOW_AVERAGE_SHIFT))
            {
                iv.vff_multiplier = K_FEED_FORWARD / AC_MIN_OFF_SQ_AVG;
                //Q30/Q15 limit to minimum operating voltage to avoid overflow
            }
            else
            {
                iv.vff_multiplier = K_FEED_FORWARD / (iv.vin_squared_slow_average >>
                    VRECT_SQUARED_SLOW_AVERAGE_SHIFT);
            }
        }
    }
}

```



```

    }
}

```

### 3.6 Calculate Average Current Reference

Now we got A, B, C, we can calculate the average current reference. This is done in 2 functions:

First, calculate  $K_m * A * B$ :

```

inline void handle_voltage_loop(void)
{
    iv.i_target_average = ((iv.vff_multiplier >> 5) * proportional_integral(iv.vbus_target - v.adc_avg[VBUS_CHANNEL])) >> 11;
}

```

Then, calculate  $K_m * A * B * C$ , which is the average current reference. As mentioned in 3.1, this average current reference needs to be translated to instantaneous current as if it is sensed at the middle point of CT output.

### 3.7 Translate average reference to instantaneous reference

For PFC with CT sensing, because the current transformer is placed right above the switch, it only senses the switch current, which is only part of the inductor current. In a digitally controlled implementation using the UCD3138, this current signal is measured at the middle of PWM on time  $T_a$ . It is an instantaneous value, represented as  $I_{sense}$  in Figures 3 and 4 below. The measured switching current  $I_{sense}$  is equal to the average PFC inductor current only when the inductor is in continuous conduction mode. When the inductor current becomes discontinuous,  $I_{sense}$  is not equal to the average PFC inductor current any more. In order to compute the inductor average current, the relationship between center point sensing of the current  $I_{sense}$  and the actual average inductor current over a switching period should be derived and be applicable for both continuous conduction mode (CCM) and discontinuous conduction mode (DCM).

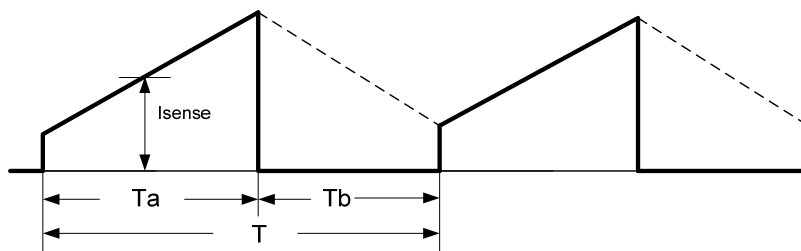

**Figure 3. Sensed current waveform at continuous conduction mode**

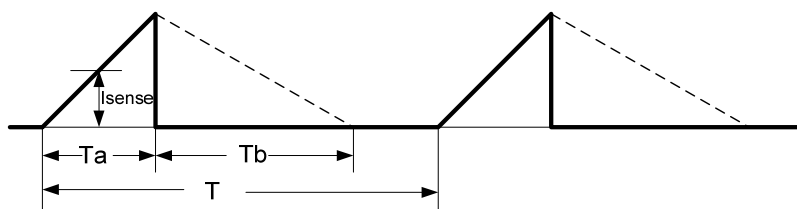

**Figure 4. Sensed current waveform at discontinuous conduction mode**

For a boost-type converter in steady state operation, the volt-seconds applied to the boost inductor should be balanced in each switching period:

$$T_a * V_{in} = T_b * (V_o - V_{in}) \quad (7)$$

Here  $T_a$  is the PWM on time,  $T_b$  is the PWM off time,  $V_{in}$  is input voltage, and  $V_o$  is output voltage, assuming all power devices are ideal.

From figures 3 and 4, we can calculate the inductor average current  $I_{ave}$  in terms of  $I_{sense}$ :

$$I_{ave} = I_{sense} * \frac{(T_a + T_b)}{T} \quad (8)$$

Where T is the switching period.

Combine (7) and (8) together, we get:

$$I_{sense} = \frac{I_{ave} * T * (V_o - V_{in})}{T_a * V_o} \quad (9)$$

Through Equation 9, the average inductor current  $I_{ave}$  is interpreted in an instantaneous switch current  $I_{sense}$ .  $I_{ave}$  is the desired current and  $I_{sense}$  is the current reference for current control loop. The real instantaneous switch current is sensed and compared with this reference, the error is sent to a fast error ADC (EAP), and finally the digitized error signal is sent to a digital compensator to close the current control loop.

```

inline void calculate_current_target_ct(void)
{
    int32 pointer;

    //for EMI CAP compensation
    iv.cir_buff[iv.cir_buff_ptr] = iv.vin_filtered;
    pointer = (iv.cir_buff_ptr - iv.cir_buff_delay) & 0x3f; //get pointer to delayed signal
    iv.cir_buff_ptr = (iv.cir_buff_ptr + 1) & 0x3f;

    iv.vbus_scaled = (iv.adc_avg[VBUS_CHANNEL] * VBUS_TO_VAC_SCALING) >> 15;

    if(iv.vbus_scaled > iv.vin_filtered)
    {
        iv.numerator_1 = iv.vbus_scaled - iv.vin_filtered;
    }
    else
    {
        iv.numerator_1 = 0;
    }

    iv.numerator_2 = (iv.i_target_average * iv.numerator_1) >> 8;

    iv.numerator_3 = (iv.cir_buff[pointer] * iv.numerator_2);

    //for phase 1
    iv.cla1_output_filtered = (Uint32)Filter1Regs.FILTERYNREAD.bit.YN+iv.cla1_output_filtered - (iv.cla1_output_filtered>>2);

    iv.denominator = ((iv.cla1_output_filtered >> 6) * iv.vbus_scaled) >> 11;

    iv.i_target_sensed = (iv.numerator_3 / iv.denominator) + iv.i_target_offset;

    if(iv.i_target_sensed > 0x3ff) //saturate current target at maximum current
    {
        iv.i_target_sensed = 0x3ff;
    }
    FeCtrl1Regs.EADC_DAC.bit.DAC_VALUE = iv.i_target_sensed << 4; //use EADC1

    //for phase 2
    iv.cla2_output_filtered = (Uint32)Filter2Regs.FILTERYNREAD.bit.YN+iv.cla2_output_filtered - (iv.cla2_output_filtered>>2);

```

```

iv.denominator = ((iv.cla2_output_filtered >> 6) * iv.vbus_scaled) >> 11;

iv.i_target_sensed = (iv.numerator_3 / iv.denominator) + iv.i_target_offset;

if(iv.i_target_sensed > 0x3ff) //saturate current target at maximum current
{
    iv.i_target_sensed = 0x3ff;
}
FeCtrl2Regs.EADC DAC.bit.DAC_VALUE = iv.i_target_sensed << 4; //use EADC2
}

```

### 3.8 Current Feed Back Front End Configuration

The Front End measures the difference between the current feed back signal and the current reference calculated in 3.7. It passes this digital error information to the filter. UCD3138 is very flexible, the front end, filter and DPWM are multi-to-multi connection. Since there are two current loops, it needs to determine which front end, which filter and which DPWM belong to which loop. The following code example is based on PWR026 PFC EVM hardware, in which loop1 consists FE1, CLA1, DPWM1 and controls phase 1, loop2 consists FE2, CLA2 DPWM2 and controls phase 2. Other configurations are also possible. For detail of how to configure UCD3138 digital peripherals, please refer to programmer manual [4].

```

void init_front_end1(void) //for CT1 sensing
{
    FeCtrl1Regs.EADC DAC.bit.DAC_VALUE = 0;
}

void init_front_end2(void) //for CT2 sensing
{
    FeCtrl2Regs.EADC DAC.bit.DAC_VALUE = 0;
}

void init_loop_mux(void)
{
    LoopMuxRegs.SAMPTRIGCTRL.bit.FE1_TRIG_DPWM1_EN = 1; //Use DPWM1 sample trigger for FE1
    LoopMuxRegs.SAMPTRIGCTRL.bit.FE2_TRIG_DPWM2_EN = 1; //Use DPWM2 sample trigger for FE2

    LoopMuxRegs.FILTERMUX.bit.FILTER1_FE_SEL = 1; //use EADC1 to drive filter 1
    LoopMuxRegs.FILTERMUX.bit.FILTER2_FE_SEL = 2; //use EADC2 to drive filter 2

    LoopMuxRegs.FILTERMUX.bit.FILTER1_PER_SEL = 1; //CLA1 switching period select from DPWM1
    LoopMuxRegs.FILTERMUX.bit.FILTER2_PER_SEL = 2; //CLA2 switching period select from DPWM2

    LoopMuxRegs.DPWMMUX.bit.DPWM1_FILTER_SEL = 1; //CLA1 is providing input to DPWM1
    LoopMuxRegs.DPWMMUX.bit.DPWM2_FILTER_SEL = 2; //CLA2 is providing input to DPWM2
    LoopMuxRegs.DPWMMUX.bit.DPWM2_SYNC_SEL = 1; //DPWM1 is the master for DPWM2
}

```

### 3.9 Current Loop Filter Configuration

The filter takes the error signal from Front End and passes it through a 2-pole 2-zero digital filter which compensates the disturbance of the current loop. The filter needs to be initialized such that once powered up, the current loop will use the already well tuned control parameters to close the loop:

```

void init_filter1(void)
{
    MiscAnalogRegs.CLKTRIM.bit.HFO_LN_FILTER_EN = 1;

    Filter1Regs.FILTERCTRL.bit.OUTPUT_MULT_SEL = 1; //PID output multiply with period
    Filter1Regs.FILTERCTRL.bit.OUTPUT_SCALE = 0; //no scale
}

```

```

Filter1Regs.FILTERKICLPHI.bit.KI_CLAMP_HIGH = 0x7FFF0;
Filter1Regs.FILTERKICLPLO.bit.KI_CLAMP_LOW = 0x800010;

Filter1Regs.FILTERYNCLPHI.all = 0x785000;//clamp to prevent CT from saturation 94%
Filter1Regs.FILTERYNCLPLO.all = 0;

Filter1Regs.FILTERCTRL.bit.FILTER_EN = 1;
//enable OK here, because nothing will happen until DPWM and front end are globally enabled
}

void init_filter2(void)
{
    Filter2Regs.FILTERCTRL.bit.OUTPUT_MULT_SEL = 1; //PID output multiply with period
    Filter2Regs.FILTERCTRL.bit.OUTPUT_SCALE = 0; //no scale

    Filter2Regs.FILTERKICLPHI.bit.KI_CLAMP_HIGH = 0x7FFF0;
    Filter2Regs.FILTERKICLPLO.bit.KI_CLAMP_LOW = 0x800010;

    Filter2Regs.FILTERYNCLPHI.all = 0x785000;//clamp to prevent CT from saturation 94%
    Filter2Regs.FILTERYNCLPLO.all = 0;

    Filter2Regs.FILTERCTRL.bit.FILTER_EN = 1;
    //enable OK here, because nothing will happen until DPWM and front end are globally enabled
}

void init_filters(void)
{
    init_filter1();
    init_filter2();
}

```

In PWR026 PFC EVM, the well tuned filter parameters  $k_p$ ,  $k_i$ ,  $k_d$  and  $\alpha$  are stored in data flash. Upon power up, they are loaded from data flash to corresponding registers.

```

void copy_configuration_to_registers(volatile struct FILTER_REGS *dest)
{
    //copy PFC configuration
    iv.vbus_voltage = pfc_config_in_ram.PFC_SETPOINT.VOUT_COMMAND +
        pfc_config_in_ram.PFC_CAL.VOUT_CAL_OFFSET;
    iv.vbus_setpoint = ((Uint32)(iv.vbus_voltage * 4095) / VBUS_FULL_RANGE);

    if(iv.supply_state >= STATE_PFC_ON)
    {
        iv.vbus_target = ((int32)((iv.vbus_voltage * 4095)/VBUS_FULL_RANGE));
    }

    FaultMuxRegs.ACOMPCTRL2.bit.ACOMP_F_THRESH =
        ((Uint32)(pfc_config_in_ram.PFC_SETPOINT.VOUT_OV_LIMIT * 127) / VBUS_FULL_RANGE);

    switching_frequency = pfc_config_in_ram.PFC_SETPOINT.FREQUENCY;

    //copy voltage loop gains
    iv.pis.kp = pfc_config_in_ram.PI_GAINS.KP;
    iv.pis.ki = pfc_config_in_ram.PI_GAINS.KI;
    iv.pis.kp_nl = pfc_config_in_ram.PI_GAINS.KP_NL;
    iv.pis.ki_nl = pfc_config_in_ram.PI_GAINS.KI_NL;
    iv.pis.nl_threshold = (pfc_config_in_ram.PI_GAINS.NL_THRESHOLD << 12) / VBUS_FULL_RANGE;

    //copy current loop gains for phase 1

```

```

dest->COEFCONFIG.all = pfc_config_in_ram.COEFCONFIG.all;
dest->FILTERKPCOEF0.all = pfc_config_in_ram.FILTERKPCOEF0.all;
dest->FILTERKPCOEF1.all = pfc_config_in_ram.FILTERKPCOEF1.all;
dest->FILTERKICOEF0.all = pfc_config_in_ram.FILTERKICOEF0.all;
dest->FILTERKICOEF1.all = pfc_config_in_ram.FILTERKICOEF1.all;
dest->FILTERKDCOEF0.all = pfc_config_in_ram.FILTERKDCOEF0.all;
dest->FILTERKDCOEF1.all = pfc_config_in_ram.FILTERKDCOEF1.all;
dest->FILTERKDALPHA.all = pfc_config_in_ram.FILTERKDALPHA.all;
dest->FILTERNL0.all = pfc_config_in_ram.FILTERNL0.all;
dest->FILTERNL1.all = pfc_config_in_ram.FILTERNL1.all;
dest->FILTERNL2.all = pfc_config_in_ram.FILTERNL2.all;
dest->FILTERCTRL.bit.NL_MODE = fc_config_in_ram.FILTERMISC.bit.NL_MODE;
    
```

*//copy current loop gains for phase 2*

```

Filter2Regs.COEFCONFIG.all = pfc_config_in_ram.COEFCONFIG.all;
Filter2Regs.FILTERKPCOEF0.all = pfc_config_in_ram.FILTERKPCOEF0.all;
Filter2Regs.FILTERKPCOEF1.all = pfc_config_in_ram.FILTERKPCOEF1.all;
Filter2Regs.FILTERKICOEF0.all = pfc_config_in_ram.FILTERKICOEF0.all;
Filter2Regs.FILTERKICOEF1.all = pfc_config_in_ram.FILTERKICOEF1.all;
Filter2Regs.FILTERKDCOEF0.all = pfc_config_in_ram.FILTERKDCOEF0.all;
Filter2Regs.FILTERKDCOEF1.all = pfc_config_in_ram.FILTERKDCOEF1.all;
Filter2Regs.FILTERKDALPHA.all = pfc_config_in_ram.FILTERKDALPHA.all;
Filter2Regs.FILTERNL0.all = pfc_config_in_ram.FILTERNL0.all;
Filter2Regs.FILTERNL1.all = pfc_config_in_ram.FILTERNL1.all;
Filter2Regs.FILTERNL2.all = pfc_config_in_ram.FILTERNL2.all;
Filter2Regs.FILTERCTRL.bit.NL_MODE = pfc_config_in_ram.FILTERMISC.bit.NL_MODE;
    
```

```

FeCtrl1Regs.EADCCTRL.bit.AFE_GAIN = pfc_config_in_ram.FILTERMISC.bit.AFE_GAIN;
FeCtrl2Regs.EADCCTRL.bit.AFE_GAIN = pfc_config_in_ram.FILTERMISC.bit.AFE_GAIN;
Dpwm1Regs.DPWMCTRL2.bit.SAMPLE_TRIG1_OVERSAMPLE =
    pfc_config_in_ram.FILTERMISC.bit.SAMPLE_TRIG1_OVERSAMPLE;
Dpwm2Regs.DPWMCTRL2.bit.SAMPLE_TRIG1_OVERSAMPLE =
    pfc_config_in_ram.FILTERMISC.bit.SAMPLE_TRIG1_OVERSAMPLE;
    
```

```

}
    
```

### 3.10 DPWM Configuration

The output of the compensator is passed to a Digital PWM (DPWM) generator. The DPWM has two outputs, which can be configured in many different ways to accommodate different power topologies. Interleaved PFC with CT sensing, requires an accurate measurement of the center point of the CT output. To achieve this, DPWMB is used and configured for operation in Triangular modulation. In this mode, the PWM pulse is centered in the middle of the period, rather than starting at one end or the other. In Triangular Mode, only DPWM B is available. It is very easy to put a fixed sample trigger exactly in the center of the on-time, because the center of the on-time does not move in this mode. The following code example accommodates PWR026 PFC EVM, in which DPWM1B and DPWM2B are used and configured as Triangular mode.

```

void init_dpwm1(void) // DPWM1B is used to drive 1st phase
{
    Dpwm1Regs.DPWMCTRL0.bit.PWM_EN = 0; //disable everything

    Dpwm1Regs.DPWMCTRL1.bit.GPIO_A_EN = 1; //turn off DPWM1A for now
    Dpwm1Regs.DPWMCTRL1.bit.GPIO_B_EN = 1; //turn off DPWM1B for now

    // Enable CBC and Blanking windows
    Dpwm1Regs.DPWMCTRL0.bit.CBC_PWM_AB_EN = 1; // Enable cycle by cycle current limit.
    Dpwm1Regs.DPWMCTRL0.bit.BLANK_B_EN = 1; // Enable blanking
    Dpwm1Regs.DPWMBLKBBEG.all = 0x0000;
    Dpwm1Regs.DPWMBLKBEND.all = 0x0500;

    Dpwm1Regs.DPWMFLTCTRL.bit.B_MAX_COUNT = 2;
    
```

```

Dpwm1Regs.DPWMFLTCTRL.bit.ALL_FAULT_EN = 1; //enable this for OVP

Dpwm1Regs.DPWMCTRL2.bit.SAMPLE_TRIG_1_EN = 1; //enable sample trigger1

Dpwm1Regs.DPWMCTRL0.bit.PWM_MODE = 3; //triangular mode
Dpwm1Regs.DPWMCTRL1.bit.EVENT_UP_SEL = 0; //update right away

Dpwm1Regs.DPWMCTRL0.bit.CLA_EN = 1;
Dpwm1Regs.DPWMCTRL0.bit.PWM_EN = 1;
//enable OK here, because nothing will happen until DPWM and front end are globally enabled
}

void init_dpwm2(void) // DPWM2B is used to drive 2nd phase
{
    Dpwm2Regs.DPWMCTRL0.bit.PWM_EN = 0; //disable everything

    Dpwm2Regs.DPWMCTRL1.bit.GPIO_A_EN = 1; //turn off DPWM2A for now
    Dpwm2Regs.DPWMCTRL1.bit.GPIO_B_EN = 1; //turn off DPWM2B for now

    // Enable CBC and Blanking windows
    Dpwm2Regs.DPWMCTRL0.bit.CBC_PWM_AB_EN = 1; // Enable cycle by cycle current limit.
    Dpwm2Regs.DPWMCTRL0.bit.BLANK_B_EN = 1; // Enable blanking
    Dpwm2Regs.DPWMBLKBBEG.all = 0x0000;
    Dpwm2Regs.DPWMBLKBEND.all = 0x0500;

    Dpwm2Regs.DPWMFLTCTRL.bit.B_MAX_COUNT = 2;
    Dpwm2Regs.DPWMFLTCTRL.bit.ALL_FAULT_EN = 1; //enable this for OVP

    Dpwm2Regs.DPWMCTRL2.bit.SAMPLE_TRIG_1_EN = 1; //enable sample trigger1

    Dpwm2Regs.DPWMCTRL0.bit.PWM_MODE = 3; //triangular mode
    Dpwm2Regs.DPWMCTRL0.bit.MSYNC_SLAVE_EN = 1; //slave mode
    Dpwm2Regs.DPWMCTRL1.bit.EVENT_UP_SEL = 0; //update right away

    Dpwm2Regs.DPWMCTRL0.bit.CLA_EN = 1;
    Dpwm2Regs.DPWMCTRL0.bit.PWM_EN = 1;
    //enable OK here, because nothing will happen until DPWM and front end are globally enabled
}

void set_new_switching_frequency(void)
{
    iv.switching_period = (SWITCH_FREQ_NUMERATOR/switching_frequency) << 4;
    iv.period_times_2_14 = iv.switching_period << 14;
    iv.dither_max_period = (SWITCH_FREQ_NUMERATOR/(switching_frequency - 4)) << 4;
    iv.dither_min_period = (SWITCH_FREQ_NUMERATOR/(switching_frequency + 4)) << 4;
    iv.dither_step = ((iv.dither_max_period - iv.dither_min_period) << 14)/DITHER_PERIOD;
    //step for dither value

    Dpwm1Regs.DPWMPRD.all = iv.switching_period; //new period for new frequency
    Dpwm2Regs.DPWMPRD.all = iv.switching_period; //new period for new frequency
    Dpwm1Regs.DPWMSAMPTRIG1.all = (iv.switching_period >> 1) + (iv.sample_trigger_offset * 4);
    // half way plus some for driver delays
    Dpwm2Regs.DPWMSAMPTRIG1.all = (iv.switching_period >> 1) + (iv.sample_trigger_offset * 4);
    // half way plus some for driver delays;
    Dpwm1Regs.DPWMPHASETRIG.all = iv.switching_period >> 1; //50% delay for next phase
}

void init_dpwms(void)
{
    init_dpwm1();
}

```

```

    init_dpwm2();
    set_new_switching_frequency();
}

```

## 4 System Protection

System protection includes current protection and voltage protection. There are two levels of over voltage protection, one is implemented through software with a lower threshold, and the other is through an on chip analog comparator with a higher threshold. The current is protected as cycle-by-cycle based.

### 4.1 Software OVP Protection

This is a pure software OVP protection. Vout is measured by an ADC, the output of ADC is filtered for measurement noise immunity, and then compared with a programmable threshold. The PWM will shut down if the measurement is greater than a user programmable threshold. The ADC continues monitoring Vout, PWM will turn back on once Vout drops below its setpoint. This allows the PFC to enter a hiccup mode. This will be useful for OVP conditions that are not caused by hardware failure, but by a sudden operating condition change, such as a load transient.

```

inline void pfc_on_state_handler(void)
{
    if(iv.vin_squared_average > VAC_MIN_OFF_SQ_AVG) //if Vac above 80 volts
    {
        if(iv.adc_avg[VBUS_CHANNEL] > VBUS_DPWM_OFF_LEVEL) //if we've hit OVP
        {
            turn_off_pfc();
            iv.supply_state = STATE_PFC_HICCUP;
        }
    }
    else
    {
        turn_off_pfc();
        init_miscellaneous();
        iv.supply_state = STATE_IDLE;
    }
}

inline void pfc_hiccup_state_handler(void)
{
    if(iv.adc_avg[VBUS_CHANNEL] < VBUS_DPWM_ON_LEVEL) //if OVP gone
    {
        LoopMuxRegs.GLBEN.all = 0x70F; //global enable all Front_ends and DPWMs
        turn_on_pfc();
        MiscAnalogRegs.GLBIOVAL.bit.TMR_PWM1_IO_VALUE = 0; //turn off LED3
        iv.supply_state = STATE_PFC_ON;
    }
}

```

### 4.2 Hardware OVP Protection

As shown in Figure 1, Vout is also connected to an on chip analog comparator COMP\_F. the comparator is configured to turn off PWM automatically once get triggered. The comparator's threshold is also programmable, and its threshold is usually set a little bit higher than the software OVP. This provides a fast OVP protection. If this OVP gets triggered, this usually means the PFC has serious hardware issue. For safety purpose, it will be latched there once shut down.

Following is the code to configure this OVP:

```
// Enable ACOMP-F pin and connect to DPWM-1 and DPWM-2 for Vbus OV protection
FaultMuxRegs.DPWM1FAULTDET.bit.PWMB_ACOMP_F_EN = 1; // Connect ACOMP-F to DPWM-1
FaultMuxRegs.DPWM2FAULTDET.bit.PWMB_ACOMP_F_EN = 1; // Connect ACOMP-F to DPWM-2
FaultMuxRegs.ACOMPCTRL2.bit.ACOMP_F_SEL = 0; // Use threshold register for trip
FaultMuxRegs.ACOMPCTRL2.bit.ACOMP_F_POL = 1; // Above thresh to trip
FaultMuxRegs.ACOMPCTRL2.bit.ACOMP_F_THRESH = ((Uint32)(PFC_CONFIG_TEMP.PFC_SETPOINT.VOUT_OV_LIMIT *
127) / VBUS_FULL_RANGE);
```

### 4.3 Cycle by Cycle Current Protection

The current is protected through on chip analog comparator COMP\_D and COMP\_E. It is cycle-by-cycle (CBC) based. Once the analog comparator is triggered, the PWM is chopped for the remaining cycle, but it will turn back on the next switching cycle. The code to configure the analog comparator for CBC is:

```
// Enable ACOMP-D pin and connect to current limit on DPWM-1
FaultMuxRegs.DPWM1CLIM.bit.ACOMP_D_EN = 1; // Connect ACOMP-D to DPWM-1
FaultMuxRegs.ACOMPCTRL1.bit.ACOMP_D_SEL = 0; // Use threshold register for trip
FaultMuxRegs.ACOMPCTRL1.bit.ACOMP_D_POL = 1; //Above thresh to trip
FaultMuxRegs.ACOMPCTRL1.bit.ACOMP_D_THRESH = OC_COMPARATOR; // Trip value

// Enable ACOMP-E pin and connect to current limit on DPWM-2
FaultMuxRegs.DPWM2CLIM.bit.ACOMP_E_EN = 1; // Connect ACOMP-E to DPWM-2
FaultMuxRegs.ACOMPCTRL2.bit.ACOMP_E_SEL = 0; // Use threshold register for trip
FaultMuxRegs.ACOMPCTRL2.bit.ACOMP_E_POL = 1; // Above thresh to trip
FaultMuxRegs.ACOMPCTRL2.bit.ACOMP_E_THRESH = OC_COMPARATOR; // Trip value
```

## 5 Advanced Features

The following lists some of the common used features for interleaved PFC. For more advanced PFC features, please refer to [2].

### 5.1 Frequency Dithering

Frequency dithering refers to modulating the switching frequency to achieve a reduction in conducted EMI noise beyond the capability of the line filter. This total range from minimum to maximum frequency is defined as the dither magnitude, and is centered on the nominal switching frequency. The rate at which PWM traverses from one extreme to the other and back again is defined as the dither rate. Both these two parameters are programmable.

```
inline void frequency_dithering(void)
{
    if(status_1.bits.dither_enabled == 1)
    {
        if(iv.dither_direction == 1)
        {
            iv.period_times_2_14 = iv.period_times_2_14 + iv.dither_step;
            iv.switching_period = iv.period_times_2_14 >> 14;
            if(iv.switching_period > iv.dither_max_period)
            {
                iv.switching_period = iv.dither_max_period;
                iv.dither_direction = 0;
            }
        }
        else //if dither direction equalled 0 to start with
```



```

{
    iv.period_times_2_14 = iv.period_times_2_14 - iv.dither_step;
    iv.switching_period = iv.period_times_2_14 >> 14;

    if(iv.switching_period < iv.dither_min_period)
    {
        iv.switching_period = iv.dither_min_period;
        iv.dither_direction = 1;
    }
}
Dpwm1Regs.DPWMPRD.all = iv.switching_period; //new period for new frequency
Dpwm2Regs.DPWMPRD.all = iv.switching_period; //new period for new frequency

Dpwm1Regs.DPWMSAMPTRIG1.all = (iv.switching_period >> 1) + (iv.sample_trigger_offset * 4);
Dpwm2Regs.DPWMSAMPTRIG1.all = (iv.switching_period >> 1) + (iv.sample_trigger_offset * 4);
Dpwm1Regs.DPWMPHASETRIG.all = iv.switching_period >> 1; //50% delay for next phase
}
}

```

### 5.2 AC Drop Detection

The AC drop detection algorithm is shown in Figure 5. Vin is sampled every 100µs. Its measurement is compared with a predetermined threshold “AC\_DROP\_V\_RECT\_THRESHOLD”. If the consecutive samples below this threshold greater than a predetermined number “AC\_DROP\_COUNT\_MAX”, then AC drop is detected, a AC drop signal is send out to host through a GPIO.

The threshold and number of consecutive samples will affect the sensitive of AC drop detection, they can be tuned base on requirement.

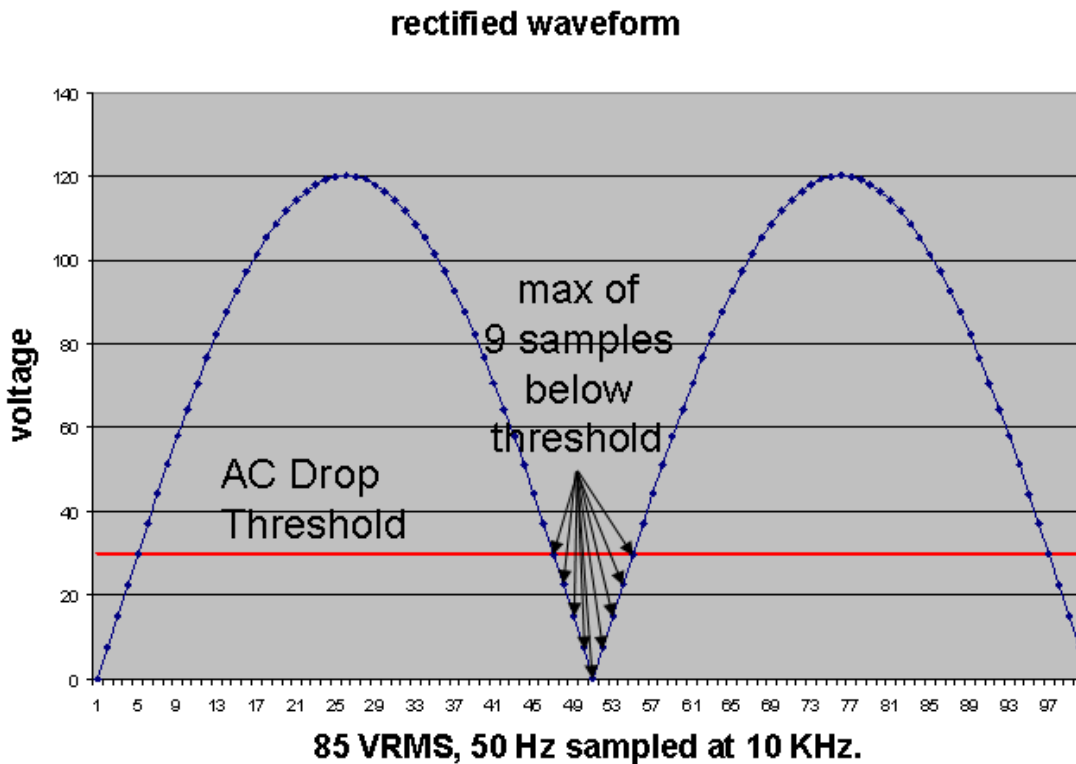

Figure 5. AC Drop Detection

The following is the code to implement this function:

```

inline void check_ac_drop(void)
{
    if(iv.vin_filtered > AC_DROP_V_RECT_THRESHOLD)
    {
        iv.ac_drop_count = 0; //if over threshold, clear counter
    }
    else
    {
        iv.ac_drop_count++;
        if(iv.ac_drop_count > AC_DROP_COUNT_MAX)
        {
            iv.ac_drop = 1;
            iv.ac_drop_recovery_not_complete = 1;
            iv.vin_squared_for_ac_drop = 0; //clear for ac recovery detection
            MiscAnalogRegs.GLBIOVAL.bit.DPWM3B_IO_VALUE = 0;
            //pull down opto to signal AC drop to primary side
        }
    }

    if(iv.vin_squared_for_ac_drop > AC_UNDROPPED_THRESHOLD)
    //if above ac not dropped threshold
    {
        iv.ac_drop = 0; // we've got enough energy, clear AC drop warning
        MiscAnalogRegs.GLBIOVAL.bit.DPWM3B_IO_VALUE = 1;
        //turn off AC drop output signal also - inactive high
    }
}

```

### 5.3 X-CAP Reactive Current Compensation

Every PFC has an electromagnetic interference (EMI) filter at the input end. The X capacitors of the EMI filter will cause the AC input current leading AC voltage, which will degrade power factor (PF). This situation gets worse at light-load and high-line. To increase the PF at light-load, we can force the inductor current delayed a little bit so that the total AC current will match the input voltage. This can be achieved by delay the current reference.

```

//stuff for EMI CAP compensation
int16 cir_buff[64]; //64buffer for vin
int32 cir_buff_ptr; //pointer for spot in cir buff;
int32 cir_buff_delay; //delay for waveform from circular buffer.
iv.cir_buff[iv.cir_buff_ptr] = iv.vin_filtered;
pointer = (iv.cir_buff_ptr - iv.cir_buff_delay) & 0x3f; //get pointer to delayed signal
iv.cir_buff_ptr = (iv.cir_buff_ptr + 1) & 0x3f;

```

This is a traditional way to compensate the X-cap reactive current; reference [5] provides another novel method with better performance.

### 5.4 Current Balancing

Due to the discrepancies of the two sets of components used in the two boost circuit, the two inductor currents will be different inevitably. This situation gets worse when then PFC enters continuous conduction mode (CCM). The unbalancing current not only causes more thermal stress on one phase, but also may miss-trigger the over current protection (OCP). Therefore, a current balancing mechanism is necessary for the interleaved PFC design.

For UCD3138 controlled interleaved PFC, since UCD3138 has 3 independent control loops inside the chip, so a dual current loops control is implemented such that each phase has its own current loop and the two loops share the same current reference, therefore the current will be balanced automatically. Moreover, the cost of the added

2<sup>nd</sup> current loop is only several lines of code, no any extra hardware circuit needed. Test result shows the current are balanced very well [6].

## 6 Firmware structure

The firmware is divided as 3 major parts: background loop, standard interrupt loop and fast interrupt loop, as shown below:

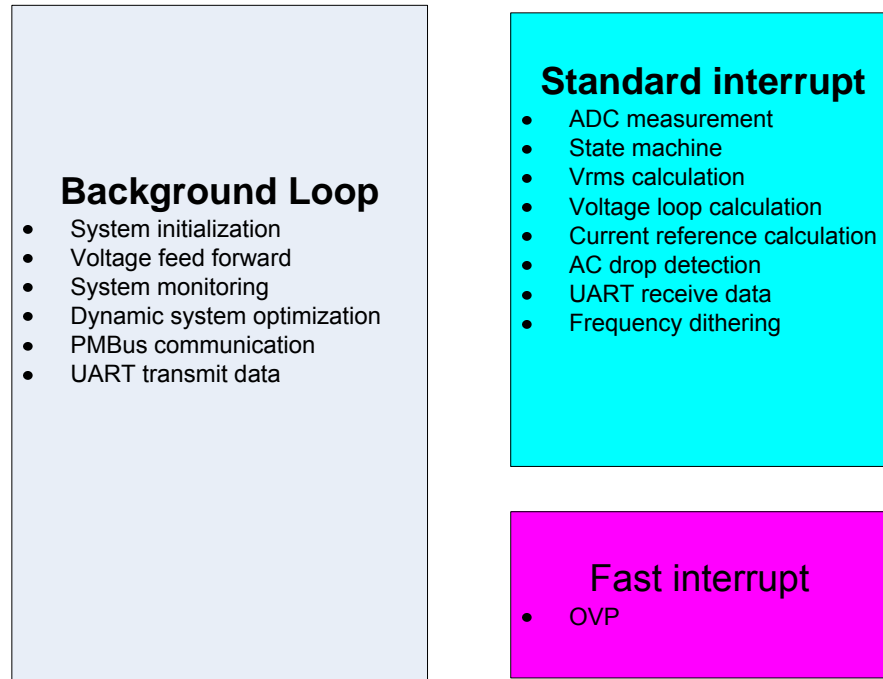

Figure 6. Firmware Structure

### 6.1 Background Loop

The firmware starts from function main(). In this function, after the system initialization, it goes to an infinite loop. All the non time critical tasks are put in this loop, it includes:

- Calculate voltage feed forward
- System monitoring
- Dynamic system optimization
- PMBus communication
- UART transmit data

User can always add any non time critical functions in this loop

```
void main()
{
    MiscAnalogRegs.IOMUX.all = 0; //enable JTAG
    look_for_interrupted_dflash_erase(); //Check to see if the last DFLASH erase was interrupted
    pmbus_write_restore_default_all(); //load PFC configuration from data flash
    init_miscellaneous();
    init_adc_polled();
    init_uart();
    init_front_ends();
    init_dpwm();
}
```

```

init_filters();
init_loop_mux();
init_fault_mux();
init_timer_interrupt();
init_pmbus();

string_out_0("\033[2J"); //clear screen

for(;;)
{
    voltage_feed_forward();

    pmbus_handler();

    system_monitoring();

    pmbus_handler();

    if(iv.supply_state == STATE_PFC_ON)
    {
        dynamic_system_optimization(); //change compensation based on Vin
    }

    pmbus_handler();

    if (erase_segment_counter > 0)
    {
        erase_task(); // Handle the DFlash segment erases
    }

    pmbus_handler();

    if(uart_tx_timeout >= UART_TX_TIME)
    {
        output_primary_secondary_message();
    }
    else
    {
        process_uart_rx_data();
    }
}
}

```

## 6.2 Standard Interrupt Loop (IRQ)

Standard interrupt loop is triggered by a timer at every 20 $\mu$ s. It is used to handle all the time critical tasks. It includes:

- ADC measurements
- PFC State machine
- Vin\_rms calculation
- Voltage loop calculation
- Current reference calculation
- Vin drop detection
- UART receive data
- Frequency dithering

However, to handle all these tasks in 20 $\mu$ s will cause interrupt overflow. To deal with this issue, the tasks distribution state machine is used to handle different task at different time interval.

### 6.2.1 Tasks Distribution State Machine

```

void standard_interrupt(void)
{
    poll_adc();
    rectify_vac();
    calculate_current_target_ct();

    switch(iv.interrupt_state)
    {
        case I_STATE_1 :
            handle_voltage_loop();
            iv.interrupt_state = I_STATE_2;
            break;

        case I_STATE_2 :
            half_cycle_processing();
            iv.interrupt_state = I_STATE_3;
            break;

        case I_STATE_3 :
            check_ac_drop();
            iv.interrupt_state = I_STATE_4;
            break;

        case I_STATE_4 :
            uart_receive_data();
            iv.interrupt_state = I_STATE_5;
            break;

        case I_STATE_5 :
            supply_state_handler(); //run PFC state machine

            frequency_dithering();

            iv.interrupt_state = I_STATE_1;
            break;

        default: //if it's in an illegal state
            iv.interrupt_state = I_STATE_1; //start it up again
            break;
    }
    TimerRegs.T16PWM0CMPCTRL.all = 3; //clear interrupt bit by a read/write.
}
  
```

### 6.2.2 PFC State Machine

PFC state machine is only one of the tasks in standard interrupt, it is called every 100µs. A typical PFC state machine is shown below:

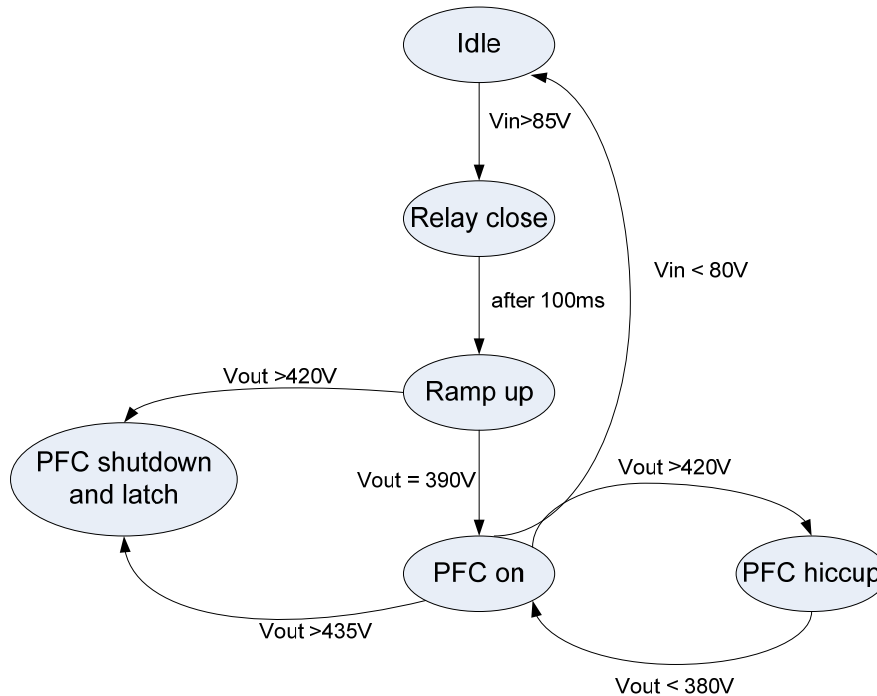

**Figure 7. PFC State Machine**

As soon as  $V_{in}$  is greater than 85V, the relay close and PFC is starting up. A 100ms delay is added after relay close to deal with the relay bouncing issue. After that, PFC will gradually ramp up its output voltage until  $V_{out}$  reaches its setpoint. At this point, PFC enters its final regulation state and will stay there until some abnormal conditions occurs, such as  $V_{out}$  over voltage or  $V_{in}$  under voltage.

```

inline void supply_state_handler(void)
{
    switch(iv.supply_state)
    {
        case STATE_IDLE :
            idle_state_handler();
            break;

        case STATE_RELAY_BOUNCE:
            relay_bounce_state_handler();
            break;

        case STATE_RAMP_UP :
            ramp_up_state_handler();
            break;

        case STATE_PFC_ON:
            pfc_on_state_handler();
            break;

        case STATE_PFC_HICCUP:
            pfc_hiccup_state_handler();
            break;

        case STATE_PFC_SHUT_DOWN:
            pfc_shut_down_state_handler();
    }
}
  
```

```

        break;
    default:
        break;
}
}

```

### 6.3 Fast Interrupt (FIQ)

The FIQ is triggered by the comparator on AD06 (Comparator F). Since DPWM1B and DPWM2B are already turned off to protect the PFC, what the FIQ does is only to report an OVP failure through a GPIO and set the PFC state into a shut down latch state. The customer can always add more time critical tasks in function:

```

#pragma INTERRUPT(fast_interrupt,FIQ)
void fast_interrupt(void)
{
    volatile int32 temp;

    turn_off_pfc();

    iv.supply_state = STATE_PFC_SHUT_DOWN;

    temp = FaultMuxRegs.FAULTMUXINTSTAT.all;//read to clear the interrupt flag
}

```

## 7 Graphic User Interface (GUI)

A graphical user interface (GUI) named “Fusion Digital Power Designer” is provided by Texas Instruments to facilitate UCD3138 controlled power converter designed. By talking to the GUI through PMBus, the PFC operating status can be monitored, its operation setpoints can be configured, and the control loop can be tuned on the fly.

The GUI is deigned to support the most popular topologies, including PFC. Different topology will have different interface. A setup id is used in the PFC firmware to tell the GUI that this is a PFC, so that when the GUI starts, it will open a interface accommodate to a PFC. In addition, the setup id specific the PFC topology (single phase, interleaved or bridgeless), and it also tells the hardware modules used in PFC current loop: which front end, which CLA and which DPWM are used. The following setup id is used in the interleaved PFC EVM PWR026:

```
#define SETUP_ID    "VERSION1|PFC004"
```

In this case, the “PFC004” is defined as an interleaved PFC, with FE1, CLA1 and DPWM1 consist the current loop for phase 1, and FE2, CLA2 and DPWM2 consist the current loop for phase 2. The two current loops use the same compensation parameters, therefore when AFE\_GAIN, PID gain, or Oversampling is changed through the GUI, the change will apply to both of the two phases.

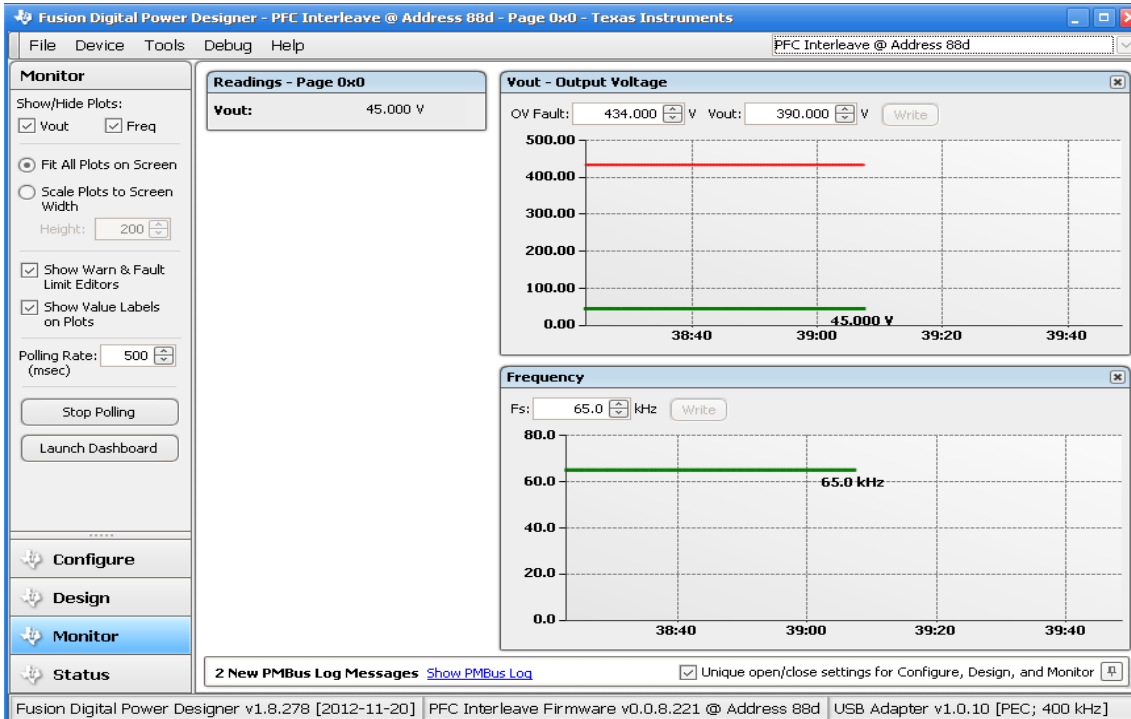

Figure 8. Monitor PFC Operating Status

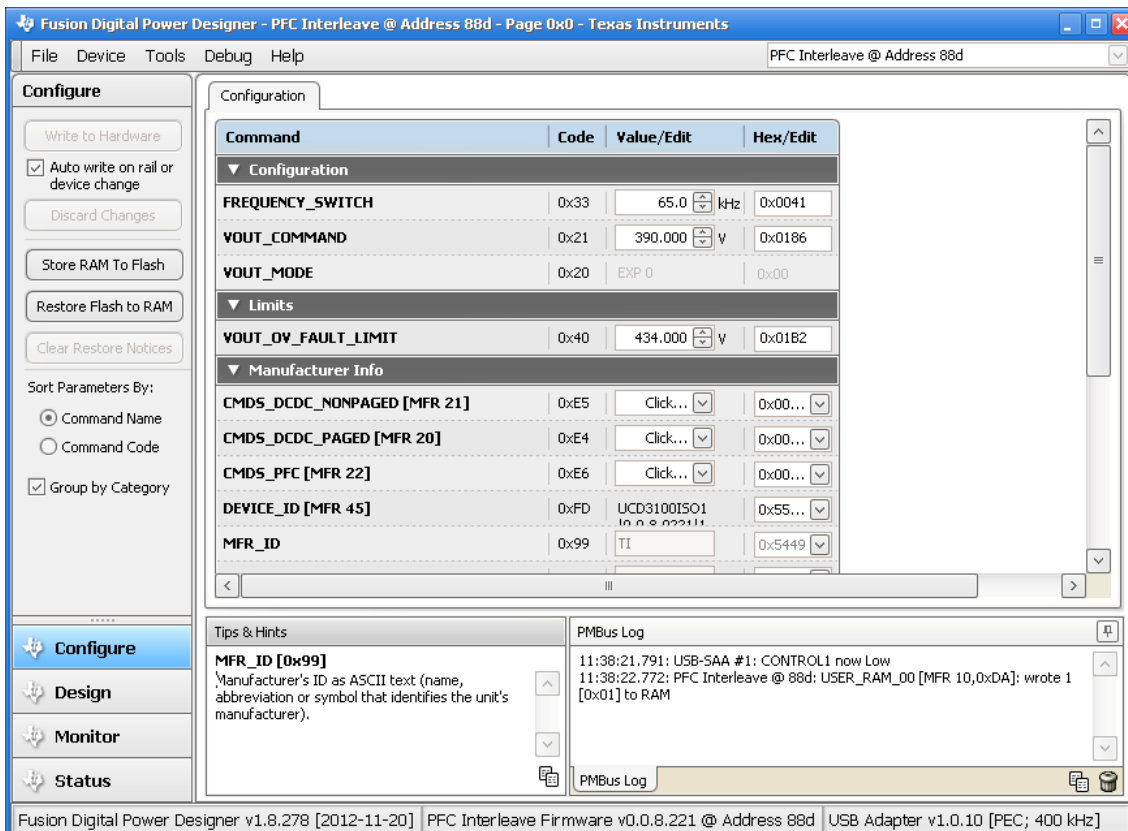
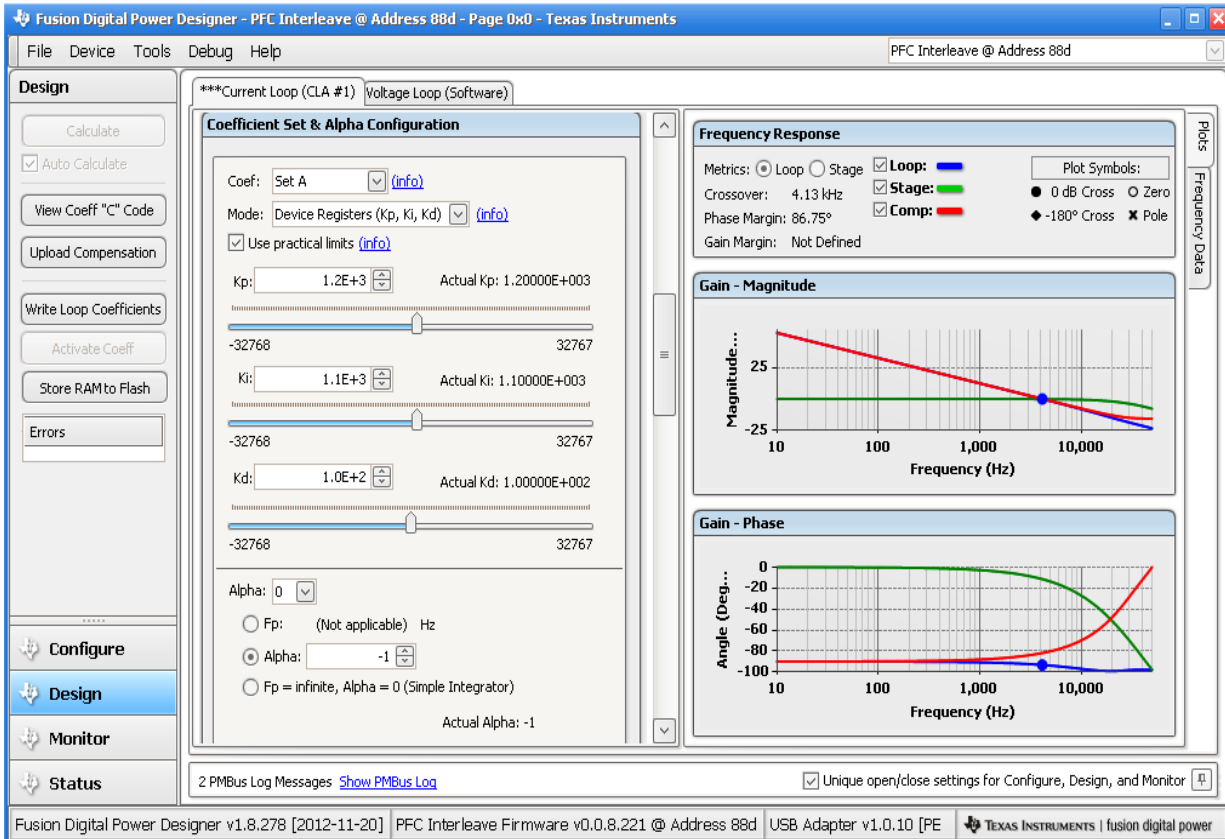

Figure 9. Configure PFC Operation Setpoints





**Figure 10. Tune PFC Control Loop**

The current and voltage loop can be tuned through the GUI. As shown in Figure 10, This GUI provides interface to tune the current and voltage control loop compensator, it also shown the loop bode plot, as well as bandwidth, phase margin, and gain margin. The loop tuning is much simplified. For details of the GUI, please refer to [7]

## 8 PFC Tuning and THD Reduction

PFC current loop tuning can be a time consuming and challenging task for the PFC design engineer. It requires the current waveform not only to be stable, but also to be smooth with very low THD and high PF. It gets more and more challenging with the ever increasing THD and PF requirements. The digital controller provides more flexibility and additional ways to achieve these increasing performance requirements. To make this task easier TI provides a GUI that greatly simplifies the work involved in these tasks. Additionally, application note [8] also provides a step by step guide of how to tune the current loop of a UCD3138 controlled PFC, it also summarizes some of the most common but effective methods to reduce the current distortion in a digitally controlled PFC.

### Reference:

- [1] UCD3138 datasheet
- [2] TI application note: Designing a UCD3138 Controlled Single Phase PFC
- [3] TI application note: Designing a UCD3138 Controlled Bridgeless PFC
- [4] SLUU995: UCD3138 Digital Power Peripherals Programmer's Manual
- [5] TI application note: A Novel EMI Filter X-Cap Reactive Current Compensation Method to increase PF
- [6] B. Sun, "Digital current balancing for an interleaved boost PFC", TI AAJ, 2013 2Q

[7] TI user guide: SLUA676

[8] TI application note: UCD3138 PFC Tuning.

## IMPORTANT NOTICE

Texas Instruments Incorporated and its subsidiaries (TI) reserve the right to make corrections, enhancements, improvements and other changes to its semiconductor products and services per JESD46, latest issue, and to discontinue any product or service per JESD48, latest issue. Buyers should obtain the latest relevant information before placing orders and should verify that such information is current and complete. All semiconductor products (also referred to herein as "components") are sold subject to TI's terms and conditions of sale supplied at the time of order acknowledgment.

TI warrants performance of its components to the specifications applicable at the time of sale, in accordance with the warranty in TI's terms and conditions of sale of semiconductor products. Testing and other quality control techniques are used to the extent TI deems necessary to support this warranty. Except where mandated by applicable law, testing of all parameters of each component is not necessarily performed.

TI assumes no liability for applications assistance or the design of Buyers' products. Buyers are responsible for their products and applications using TI components. To minimize the risks associated with Buyers' products and applications, Buyers should provide adequate design and operating safeguards.

TI does not warrant or represent that any license, either express or implied, is granted under any patent right, copyright, mask work right, or other intellectual property right relating to any combination, machine, or process in which TI components or services are used. Information published by TI regarding third-party products or services does not constitute a license to use such products or services or a warranty or endorsement thereof. Use of such information may require a license from a third party under the patents or other intellectual property of the third party, or a license from TI under the patents or other intellectual property of TI.

Reproduction of significant portions of TI information in TI data books or data sheets is permissible only if reproduction is without alteration and is accompanied by all associated warranties, conditions, limitations, and notices. TI is not responsible or liable for such altered documentation. Information of third parties may be subject to additional restrictions.

Resale of TI components or services with statements different from or beyond the parameters stated by TI for that component or service voids all express and any implied warranties for the associated TI component or service and is an unfair and deceptive business practice. TI is not responsible or liable for any such statements.

Buyer acknowledges and agrees that it is solely responsible for compliance with all legal, regulatory and safety-related requirements concerning its products, and any use of TI components in its applications, notwithstanding any applications-related information or support that may be provided by TI. Buyer represents and agrees that it has all the necessary expertise to create and implement safeguards which anticipate dangerous consequences of failures, monitor failures and their consequences, lessen the likelihood of failures that might cause harm and take appropriate remedial actions. Buyer will fully indemnify TI and its representatives against any damages arising out of the use of any TI components in safety-critical applications.

In some cases, TI components may be promoted specifically to facilitate safety-related applications. With such components, TI's goal is to help enable customers to design and create their own end-product solutions that meet applicable functional safety standards and requirements. Nonetheless, such components are subject to these terms.

No TI components are authorized for use in FDA Class III (or similar life-critical medical equipment) unless authorized officers of the parties have executed a special agreement specifically governing such use.

Only those TI components which TI has specifically designated as military grade or "enhanced plastic" are designed and intended for use in military/aerospace applications or environments. Buyer acknowledges and agrees that any military or aerospace use of TI components which have **not** been so designated is solely at the Buyer's risk, and that Buyer is solely responsible for compliance with all legal and regulatory requirements in connection with such use.

TI has specifically designated certain components as meeting ISO/TS16949 requirements, mainly for automotive use. In any case of use of non-designated products, TI will not be responsible for any failure to meet ISO/TS16949.

### Products

Audio	<a href="http://www.ti.com/audio">www.ti.com/audio</a>
Amplifiers	<a href="http://amplifier.ti.com">amplifier.ti.com</a>
Data Converters	<a href="http://dataconverter.ti.com">dataconverter.ti.com</a>
DLP® Products	<a href="http://www.dlp.com">www.dlp.com</a>
DSP	<a href="http://dsp.ti.com">dsp.ti.com</a>
Clocks and Timers	<a href="http://www.ti.com/clocks">www.ti.com/clocks</a>
Interface	<a href="http://interface.ti.com">interface.ti.com</a>
Logic	<a href="http://logic.ti.com">logic.ti.com</a>
Power Mgmt	<a href="http://power.ti.com">power.ti.com</a>
Microcontrollers	<a href="http://microcontroller.ti.com">microcontroller.ti.com</a>
RFID	<a href="http://www.ti-rfid.com">www.ti-rfid.com</a>
OMAP Applications Processors	<a href="http://www.ti.com/omap">www.ti.com/omap</a>
Wireless Connectivity	<a href="http://www.ti.com/wirelessconnectivity">www.ti.com/wirelessconnectivity</a>

### Applications

Automotive and Transportation	<a href="http://www.ti.com/automotive">www.ti.com/automotive</a>
Communications and Telecom	<a href="http://www.ti.com/communications">www.ti.com/communications</a>
Computers and Peripherals	<a href="http://www.ti.com/computers">www.ti.com/computers</a>
Consumer Electronics	<a href="http://www.ti.com/consumer-apps">www.ti.com/consumer-apps</a>
Energy and Lighting	<a href="http://www.ti.com/energy">www.ti.com/energy</a>
Industrial	<a href="http://www.ti.com/industrial">www.ti.com/industrial</a>
Medical	<a href="http://www.ti.com/medical">www.ti.com/medical</a>
Security	<a href="http://www.ti.com/security">www.ti.com/security</a>
Space, Avionics and Defense	<a href="http://www.ti.com/space-avionics-defense">www.ti.com/space-avionics-defense</a>
Video and Imaging	<a href="http://www.ti.com/video">www.ti.com/video</a>

### TI E2E Community

[e2e.ti.com](http://e2e.ti.com)